

B.5 Fundatierapport steunmast

ZUID-WEST 380 KV OOST VERBINDINGEN

Definitief ontwerp fundaties steunmasten hoogspanningslijn RLL-TLB

TenneT TSO B.V.

Rapport nr.: 21-1249, Rev. 3

Meridian doc.nr.: 002.678.00 0950630

Datum: 2022-07-07

DATUM:	11-07-2022
STATUS TENNET:	DEFINITIEF
REVISIE TENNET:	1.0





Projectnaam: Zuid-West 380 kV Oost Verbindingen
Rapport titel: Definitief ontwerp fundaties steunmasten
hoogspanningslijn RLL-TLB
Klant: TenneT TSO B.V.,
Utrechtseweg 310-B50, 6812 AR Arnhem
Contactpersoon klant: XXXXXXXXXX
Datum uitgave: 2022-07-07
Project nr.: 10124719
Organisatie unit: Overhead Lines (OHL)
Meridian doc.nr.: 002.678.00 0950630
Rapport nr.: 21-1249, Rev. 3

Energy Systems
DNV Netherlands B.V.
Utrechtseweg 310-B50
6812 AR Arnhem

Tel: 026 356 9111
Handelsregister Arnhem 09006404

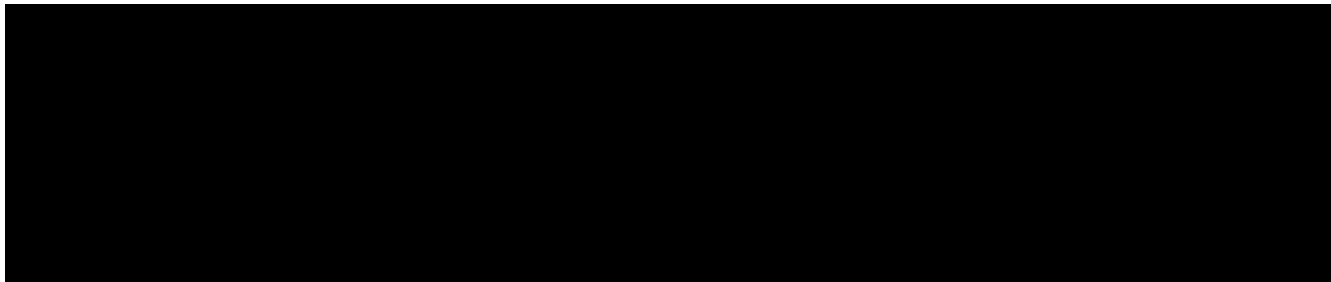

Copyright © DNV 2021. All rights reserved. Unless otherwise agreed in writing: (i) This publication or parts thereof may not be copied, reproduced or transmitted in any form, or by any means, whether digitally or otherwise; (ii) The content of this publication shall be kept confidential by the customer; (iii) No third party may rely on its contents; and (iv) DNV undertakes no duty of care toward any third party. Reference to part of this publication which may lead to misinterpretation is prohibited.

DNV Distributie:

- Open
- Intern
- Commercieel vertrouwelijk
- Vertrouwelijk
- Geheim

*Specificatie distributie: --

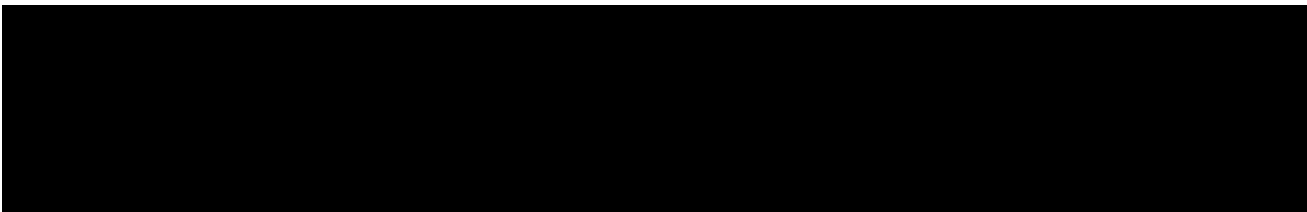

Inhoudsopgave

1	INLEIDING	1
2	UITGANGSPUNTEN EN RANDVOORWAARDEN	2
2.1	Normen	2
2.2	TenneT-specificaties	2
2.3	Ontwerp en eisenverificatie	2
2.4	Materialen	3
2.5	Software	3
2.6	Sonderingen	3
2.7	Beschrijving grondopbouw	4
2.8	Uitgangspunten geotechniek	7
2.9	Vermoeiing	9
2.10	Omgeving	9
2.11	Aarding	9
2.12	Sterkte-coördinatie	9
2.13	Bijzondere ontwerpsituatie door ontgroning	9
3	FUNDERINGSONTWERP	11
3.1	Inleiding	11
3.2	Paaltypes	11
3.3	Enkelpaalsfundering	11
3.4	Tweepaalsfundering	12
3.5	Verhoogde fundering	13
4	AANPAK.....	14
4.1	Inleiding	14
4.2	Belasting	14
4.3	Draagvermogen	14
4.4	Horizontale krachtafdracht	15
4.5	Wapening	16
5	RESULTATEN	18
5.1	Verticaal draagvermogen	18
5.2	Horizontale krachtsafdracht	18
5.3	Hoeveelheden	18
Appendix A	Fundatiebelastingen	
Appendix B	Fundatiegegevens	
Appendix C	Resultaten	
Appendix D	Uitvoer TS paalfunderingen	
Appendix E	Berekening horizontale afdracht	

1 INLEIDING

In het basisonwerp van de verbinding RLL-TLB380 in het project Zuid-West 380 kV-Oost zijn voor het vaststellen van de haalbaarheid constructieve berekeningen uitgevoerd aan de masten en fundaties. In de Definitief Ontwerpfase, moeten berekeningen verder worden uitgewerkt om te kunnen dienen voor de benodigde vergunningsdocumentatie, voor de aanbesteding en als voorbereiding voor de uitvoeringsfase. Het DO omvat het ontwerp van de mastconstructies, de fundaties en de opstijpunten in de verbinding.

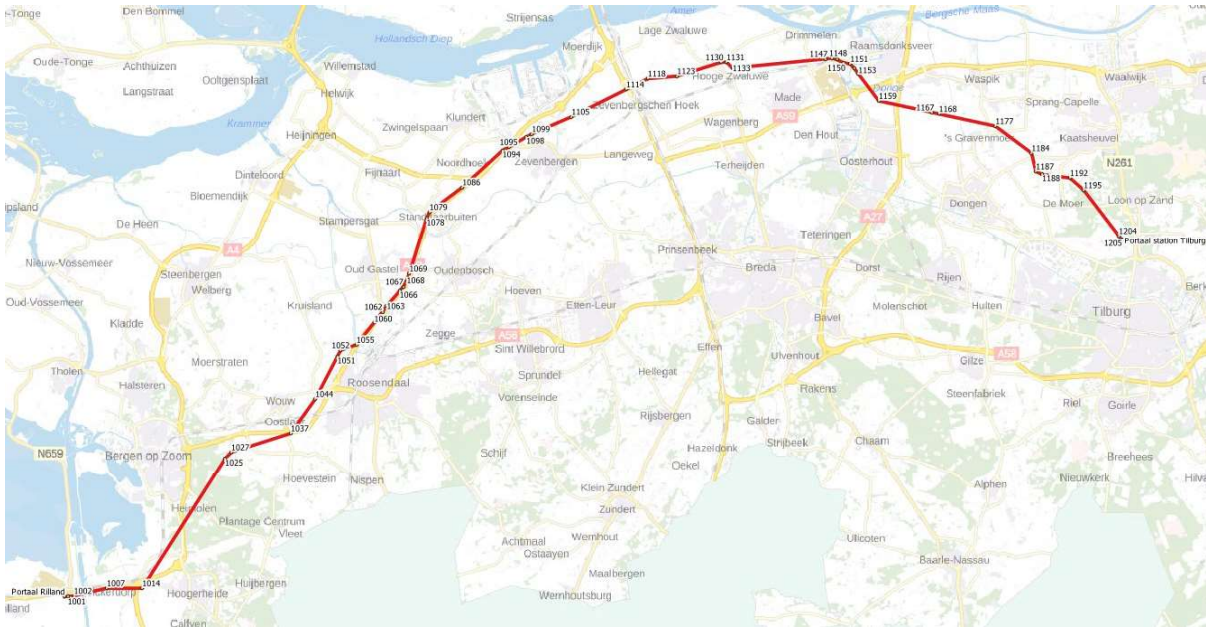

Figuur 1 Globale ligging tracé met hoekmastnummers

Het definitieve tracé van de hoogspanningslijn is nog niet vastgesteld. Daardoor zijn sonderingen op de precieze mastlocaties nog niet in uitvoering. Dit heeft tot gevolg dat voor het ontwerp van de fundaties nog geen sonderingen beschikbaar zijn. Om toch een ontwerp op te kunnen stellen is door TenneT een geotechnisch lengteprofiel opgesteld uitgaande van sonderingen in de nabijheid van het tracé. Dit lengteprofiel vormt het uitgangspunt voor de berekeningen.

De uitvoeringsfase van de fundaties zal in de vorm van een UAV GC contractvorm plaatsvinden. Dat houdt in dat in de uitvoeringsfase de sonderingen door de opdrachtnemer worden uitgevoerd. Vervolgens kan de opdrachtnemer het definitieve fundatieontwerp opstellen. De voorliggende rapportage is bedoeld om richting te geven aan het ontwerp op basis van de nu beschikbare gegevens. Het is een indicatie wat verwacht wordt in de uitvoeringsfase.

In het project worden voor mastfundaties enkelpaalsfunderingen en meerpaalsfunderingen toegepast afhankelijk van de bodemgesteldheid, het masttype en de belasting.

Deze rapportage bevat de beschrijving van het constructieve ontwerp van de fundaties voor steunmasten en de toetsing aan de eisen uit de geotechnische normen en TenneT-specificaties. Het aardingsontwerp wordt in een aparte rapportage behandeld.

In hoofdstuk 2 zijn de uitgangspunten en randvoorwaarden vanuit de van toepassing zijnde normen en TenneT-specificaties opgenomen. Hoofdstuk 3 beschrijft het ontwerp van de fundatie. De gevolgde aanpak van de berekening is hoofdstuk 4 opgenomen. Hoofdstuk 5 bevat de resultaten van de uitgevoerde toetsing.

2 UITGANGSPUNTEN EN RANDVOORWAARDEN

2.1 Normen

Er is gebruik gemaakt van de normen volgens Tabel 1.

Tabel 1 Gebruikgemaakte normen, voorschriften en richtlijnen

Norm	Titel
NEN-EN 50341-1:2013	"Overhead electrical lines exceeding AC 1 kV - Part 1: General requirements – Common"
NEN-EN 50341-2-15:2019	"Overhead electrical lines exceeding AC 1 kV Part 2 National Normative Aspects (NNA) for THE NETHERLANDS"
NEN-EN 1990+A1+A1/C2:2011	"Grondslagen van het ontwerp"
NEN-EN 1991-1-4+A1+C2:2011	"Deel 1-4: Windbelasting op constructies"
NEN-EN 1992-1-1+C2:2011/NB:2016+A1:2020	"Eurocode 2: Ontwerp en berekening van betonconstructies, deel 1-1: algemene regels en regels voor gebouwen"
NEN-EN 1993-1-1+C2+A1:2016 nl	"Eurocode 3: Ontwerp en berekening van staalconstructies, deel 1-1: algemene regels en regels voor gebouwen"
NEN-EN 1993-1-8+C2:2011/NB:2011 nl	"Ontwerp en berekening van staalconstructies, deel 1-8: ontwerp en berekening van verbindingen"
NEN-EN 1997-1+C1+A1:2016/NB:2016 nl	"Geotechnisch – Algemeen"
CUR 2001-4	"Ontwerpregels voor trekpalen"

2.2 TenneT-specificaties

In Tabel 2 zijn de documenten opgenomen die relevant zijn voor de berekeningen en toetsingen die binnen dit project in de mastrapportage uitgevoerd zullen worden.

Tabel 2 Relevante documenten t.b.v. mechanische rapportages

Nummer	Onderwerp
PVE.05.000 v3.2	PvE Lijnen
sPVE.05.001	sPvE Lijnen
SPE 04.009	paalfunderingen

2.3 Ontwerp en eisenverificatie

In Tabel 3 is de lijst opgenomen met documenten die gerelateerd zijn aan deze ontwerpportage van de fundaties van steunmasten. De belastingen in deze rapportage zijn ontleend aan de berekeningen van de mastconstructie zoals beschreven in de volgende rapportages. Daarbij zijn de reacties op de fundatie zoals berekend met PLS-TOWER gebruikt.

Tabel 3 Gerelateerde documenten

Titel	DNV-nummer	Meridiannummer
Uitgangspunten definitief ontwerp Moldaumast	21-0036	002.678.00 0876917
Verificatierapport DO Moldau	21-1246	002.678.00 0950632
Mastrapportage S/s Laag (S+0 - S+9)	21-0664	002.678.00 0920171
Mastrapportage S/s Hoog (S+18/S+24)	21-1172	002.678.00 0946389
Mastrapportage S/c	21-0728	002.678.00 0927722

2.4 Materialen

Voor het ontwerp van de mastconstructies en fundaties wordt uitgegaan van de eigenschappen volgens Tabel 4.

Tabel 4 Materialen aangepaste constructie

Staalsoort	S355J0 (t≤16 mm) S355J2 (16<t≤40 mm)
Boutkwaliteit	8.8 gerolde draad
Betonkwaliteit	C30/37
Wapeningsstaal	B500

2.5 Software

De gebruikte software wordt benoemd in Tabel 5.

Tabel 5 Toegepaste software

Software		Versie
Mastontwerp	PLS-CADD	16.65
Mastberekeningen	PLS-TOWER	16.65
Paalberekening	Technosoft Paalfunderingen	V6
Constructieve analyse	AxisVM	X5 R4h

2.6 Algemene uitgangspunten

Het ontwerp van de fundaties is gebaseerd op de uitgangspunten volgens Tabel 6.

Tabel 6 Algemene uitgangspunten

Gevolgklasse	CC2
Geotechnische categorie ¹	GC2
Ontwerplevensduur fundaties ²	100 jaar
Milieuklasse ³	XC4/XF3
Uitvoeringsklasse betonconstructies	klasse 3 conform NEN-EN 13670

2.7 Sonderingen

Bij het opstellen van deze rapportage zijn nog geen sonderingen beschikbaar aangezien de mastlocaties nog niet definitief zijn vastgesteld. Om te komen tot een ontwerp is door TenneT een geotechnisch lengteprofiel samengesteld. In dit profiel zijn over de lengte van het tracé de hoogtegegevens van het maaiveld weergegeven vanuit de Algemene Hoogtekaart Nederland 3. De vanuit openbare bron (Dino-loket) beschikbare sonderingen in de nabijheid van het tracé zijn weergegeven. Dit betreft elektrische sonderingen in digitaal formaat. Van de mechanische sonderingen die beschikbaar zijn uit de asset-gegevens vanuit de hoogspanningslijnen in de nabijheid van het nieuwe tracé is geen gebruik gemaakt.

De sonderingen bevinden zich doorgaans in de directe nabijheid van het tracé (< 500 m afstand). Voor het verkrijgen van een indicatie is dit voldoende nauwkeurig. Lokaal kunnen echter grote verschillen optreden.

Indien uit nog uit te voeren veld- en bodemonderzoeken naar voren komt dat de sonderingen te veel verschillen (30%) dan is de CUR 114 (toezicht op realisatie van paalfunderingen) van toepassing door opdrachtnemer.

¹ In AM-Req 3260 van TenneT wordt GC3 voorgeschreven, vanwege de bouw van de hoogspanningslijn in een gebied zonder risico voor aardbevingen en het ontbreken van specifieke aanvullende eisen in GC3 aan mastfundaties wordt uitgegaan van GC2.

² Belastingen vanuit de mastconstructie zijn gebaseerd op referentieperiode 50 jaar.

³ Dit is een minimum milieuklasse, bij bijzondere omstandigheden zoals verontreinigde grond kan een zwaardere milieuklasse van toepassing zijn.

2.8 Beschrijving grondopbouw

In onderstaande voorbeelden (zie Tabel 3) is de bodemopbouw opgenomen. Voor het beschrijven van de grondopbouw maken we gebruik van de sonderingen die beschikbaar zijn gesteld.

De sonderingen laten over de lengte verschillen zien in ondergrond. Westelijk van Geertruidenberg en dat betekent over circa twee derde van de lengte van het tracé is er een wisselend beeld van zandlagen en cohesieve lagen.

Noemenswaardig is hierbij dat de slappere lagen ook op vrij grote diepte voorkomen met een dikte van meerdere meters. De pakking van de zandlagen is over het algemeen tussen los en matig. Maar er zijn ook locaties met dicht gepakte lagen. Ondiep gelegen slappere lagen komen vooral voor tussen Standdaarbuiten en Moerdijk. Voor afdracht van de horizontale belastingen is dat ongunstig.

Globaal bevindt zich oostelijk van Geertruidenberg over de gehele diepte van de sondering een draagkrachtig zandpakket. Aandachtspunt zijn hier de dieper gelegen kleilagen, die voor de weerstand van de paalpunt op druk nadelige invloed hebben.

Tabel 7 Overzicht voorbeeldsonderingen

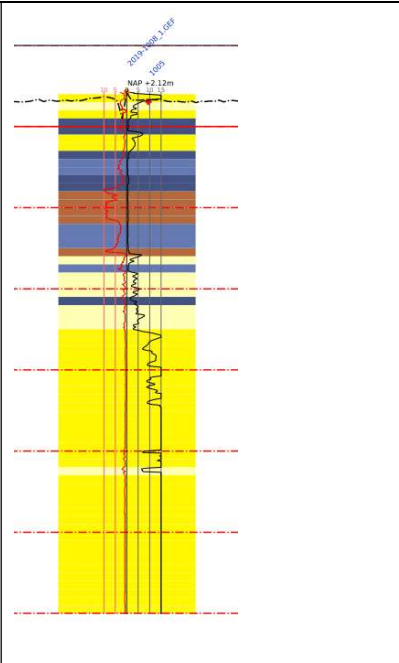
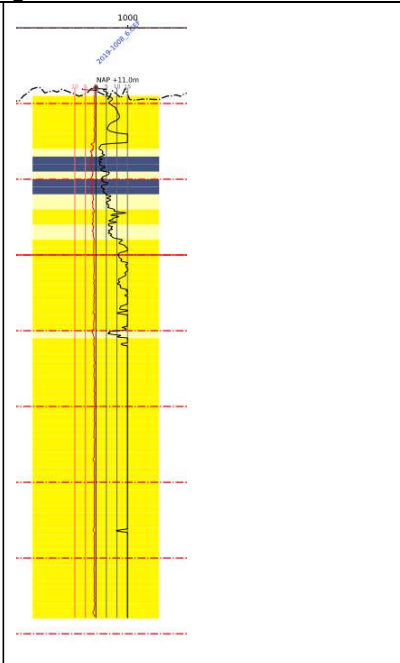
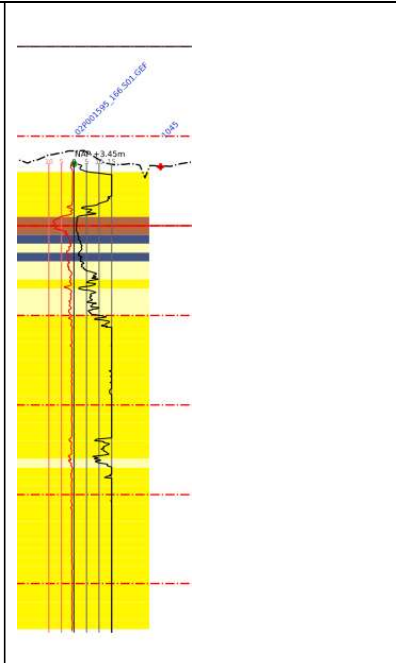
		
Mast 1005 (omgeving Völckerdorp)	Voor mast 1025, Bergen op Zoom	Mast 1045, knooppunt De Stok

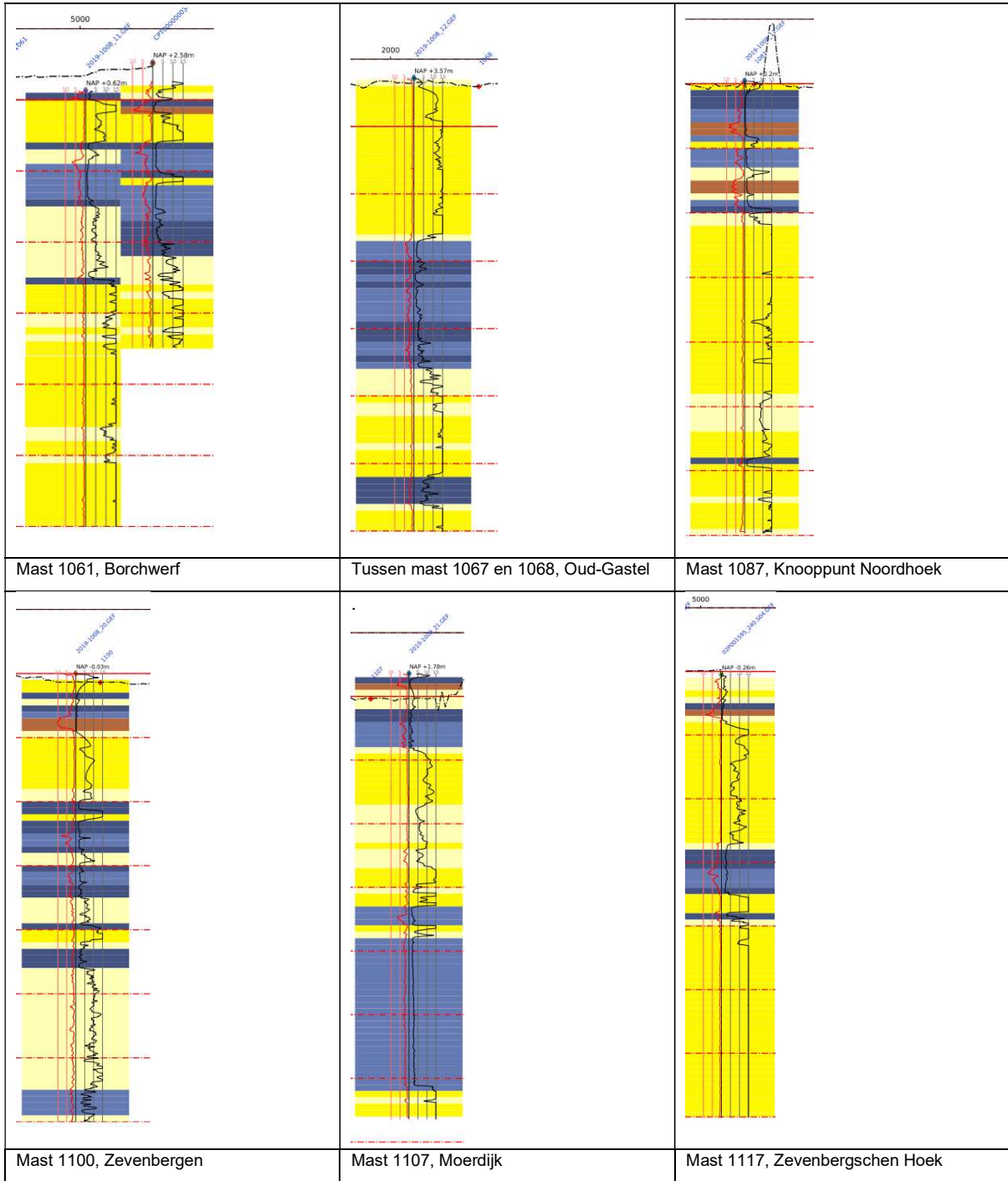

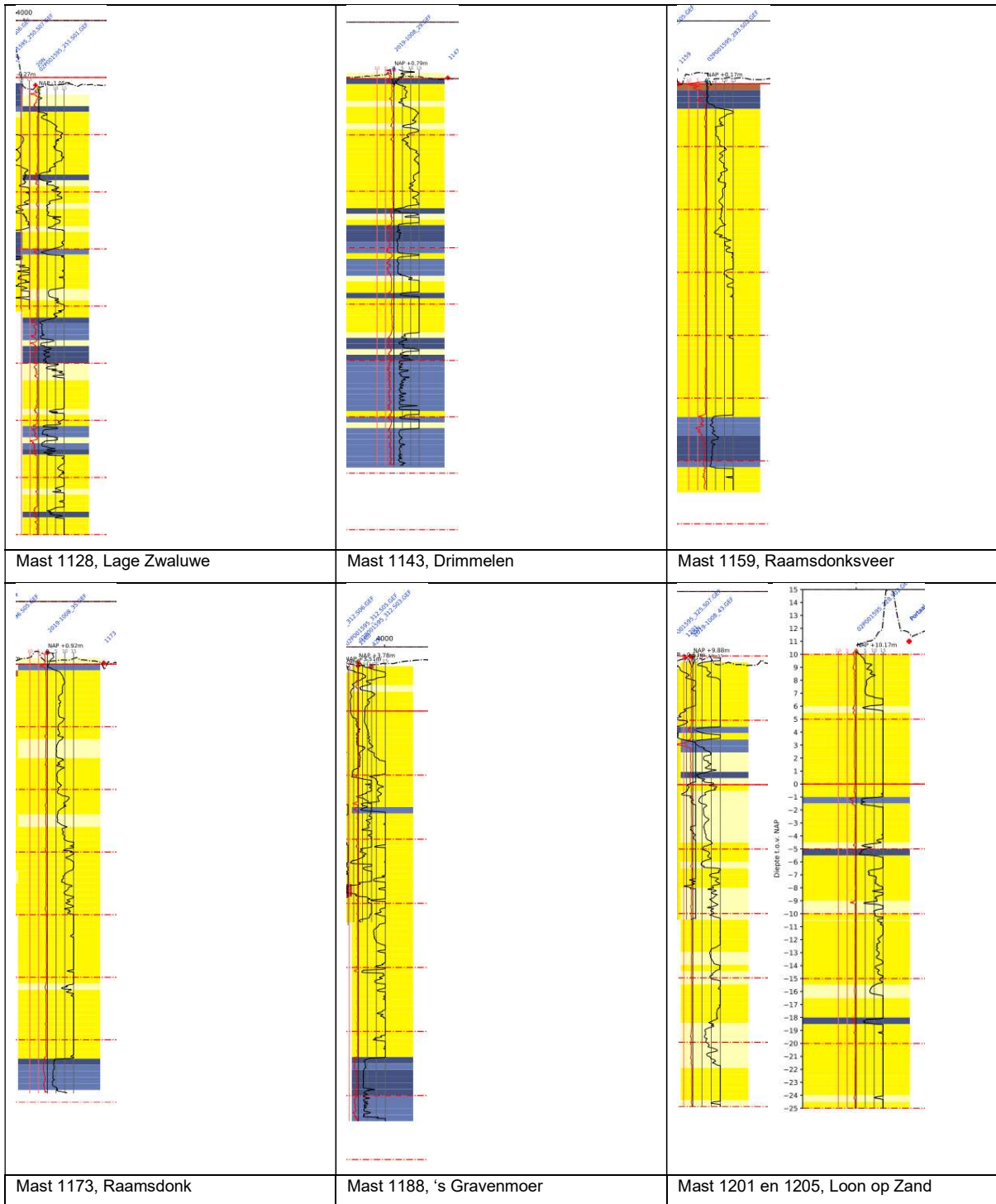

2.9 Uitgangspunten geotechniek

2.9.1 Paalklassefactoren paaltypes

In tabel 8 zijn de paalklassefactoren van de paaltypes uit deze rapportage op basis van NEN-EN 1997-1 samengevat waarmee de berekeningen worden uitgevoerd.

Tabel 8 Paalklassefactoren enkelpaalsfunderingen steunmasten

	SI Ø610/850	SI Ø762/950
Paalttype	Schroefinjectiepaal	Schroefinjectiepaal
Diameter stalen buis (m)	0,61	0,762
Diameter in berekening (m) ⁴	0,73	0,86
Factor α_s	0,009	0,009
Factor α_t	0,009	0,009
Factor α_p	0,63	0,63
Factor β	1,0	1,0

2.9.2 Kleef cohesieve lagen

In de berekeningen wordt de weerstand van de cohesieve lagen boven de draagkrachtige zandlaag meegenomen. Volgens opmerking (b) van 7.6.3.3 (8) van NEN-EN 1997-1 is de schachtwrijving tot 50% gereduceerd. Negatieve kleef is gerekend over de hoogte van de cohesieve laag en de grondlagen daarboven.

2.9.3 Correlatiefactoren

De correlatiefactoren ksi3 en ksi4 worden toegepast bij de bepaling van de karakteristieke weerstand van een paal. De waarden zijn afhankelijk van de aard van de constructie en het aantal beschikbare sonderingen. De correlatiefactoren zijn ontleend aan NEN-EN 1997-1:2016, bijlage A, tabel 10.

Fundaties met één paal per hoekpunt vallen onder “niet-stijf” met factoren volgens Tabel 8. Het aantal sonderingen dat wordt gebruikt hangt af van het dekkingsbereik van de sonderingen voor een van de vier hoekpunten. Voor het DO, waarin nog geen volledig grondonderzoek beschikbaar is, wordt uitgegaan van een dekkingsbereik per hoekpunt van één sondering: Zowel 1,39 voor ksi3 als ksi4.

Tabel 9 Correlatiefactoren niet-stijf bouwwerk

Aantal sonderingen	1	2	3	4
ksi3	1,39	1,32	1,30	1,28
ksi4	1,39	1,32	1,30	1,03

2.9.4 Materiaalfactor $\gamma_{m,var,qc}$

De parameter die de berekende draagkracht reduceert is de partiele factor $\gamma_{m,var,qc}$, volgens NEN-EN 1997-1 artikel 7.6.3.3 (8) opmerking (d). Voor een paal die een wisselende belasting ondergaat tussen trek- en druk treedt een vermindering op van de schuifweerstand. Afhankelijk van de verhouding tussen uiterste trek- en drukkracht in de SLS is de $\gamma_{m,var,qc}$ tussen de 1,0 en 1,5.

$$\gamma_{m,var,qc} = 1 + 0,25 \cdot \frac{F_{t,max,rep} - F_{t,min,rep}}{F_{t,max,rep}} \text{ en } \gamma_{m,var,qc} \leq 1,5$$

Voor steunmasten met variatie waarbij de maximale drukbelasting minimaal gelijk is aan de trekbelasting levert de formule de waarde van 1,50 op. Deze waarde zal worden gebruikt.

⁴ Uitgangspunt voor de palen met groutomhulling is in de berekening de halve dikte van de groutschil

2.9.5 Staaldikte funderingspalen

Voor het dimensioneren van stalen palen dient volgens TenneT-specificatie 04.009 rekening te worden gehouden met afname van staaldikte op basis van NEN 1993-5. Dit komt overeen met de CUR-aanbeveling 166 voor damwanden. Op dit moment is nog geen milieukundig onderzoek beschikbaar waaruit de agressiviteit of zuurtegraad van het grondwater (pH-waarde) kan worden afgeleid. De invloed van het zoutgehalte in het grondwater is gering⁵. Er moet uitgegaan worden van 100 jaar ontwerplevensduur.

Tabel 9.2. Aantasting (mm) van damwanden in bodem en ophogingen met of zonder grondwater (per blootgestelde zijde *).

Beoogde levensduur (jaar)	5 ***)	25 ***)	50	75	100
Ongeroerde, schone bodem	0,00	0,30	0,60	0,90	1,20
Verontreinigde bodem, geroerde grond	0,15	0,75	1,50	2,25	3,00
Zure bodem (veen, moeras)	0,20	1,00	1,75	2,50	3,25
Onverdichte grond (klei, zand) **)	0,18	0,70	1,20	1,70	2,20
Onverdicht, agressief ophoogmateriaal (bodemas, slakken, sintels)	0,50	2,00	3,25	4,50	5,75

Figuur 2 Tabel 9.2 uit CUR 166

Voor het DO wordt uitgegaan van zure grond en minimaal 12,5 mm dikte. Met de gereduceerde dikte van 12,5-3,25=9,25 mm is gerekend.

De aanwezigheid van zwerfstromen betekent een risico op snellere corrosie. In de nabijheid van stations is dit risico het grootst. Als mitigerende maatregel kan de buispaal geheel met gewapend beton worden gevuld zodat ook na corrosie van de stalen paal voldoende sterkte aanwezig blijft.

2.9.6 Horizontale bedding

De beddingwaardes worden gebaseerd op ontwerprichtlijn CUR228. Waarden in Tabel 9 zijn hieruit afgeleid en gelden als gemiddelde waarden. De breedte van de grond die wordt gemobiliseerd door een paal ten opzichte van de breedte van de paal wordt uitgedrukt in de schelpfactor. Empirische waarden voor de schelpfactor worden gebruikt volgens Tabel 9.

Tabel 10 Aan te houden waarden voor grondbeddingen en schelpfactoren

Grond	k_n	schelpfactor	passieve druk
	[kN/m ³]	[-]	[-]
Klei	3000	1,3	2
Veen	1500	1,2	2
Zand	15000	2,0	3

Volgens NEN-EN 50341-2-15:2019 art. 8.2. NL.4 moet het effect van variatie van bedding op de krachtsverdeling worden beschouwd. De berekeningen worden uitgevoerd voor een beddingwaarde die $\sqrt{2}$ lager is en $\sqrt{2}$ hoger is dan de tabelwaarde.

De reactie van de paalbedding is gelimiteerd tot de grenswaarde van de maximale passieve gronddruk die zich kan ontwikkelen afhankelijk van de diepte.

In Appendix E wordt verder ingegaan op de gehanteerde waarden in de berekening.

2.9.7 Verticale bedding

Bij de berekening van de eenpaalsfundering heeft de verticale bedding van de paalpunt geen invloed op de krachtsverdeling. In de berekening is een starre steun gehanteerd.

⁵ Deltares, rapport 1209030, Corrosie van stalen damwandplanken in de grond;

2.10 Vermoeiing

De fundaties worden belast door vakwerkmasten. Deze zijn vanwege de aard van de constructie niet gevoelig voor vortex shedding of andere opslingeringen door wind. De wisselende belasting van wind is een quasi-statische belasting. Dit is op basis van art. 7.3.10 van NEN-EN 50341-1:2013. Toetsing op vermoeiing door galloping, voor zover al relevant voor fundaties, is voor bestaande constructies niet vereist op basis NEN 8701.

2.11 Omgeving

De fundaties hebben een raakvlak met de omgeving. Als eerste vereisen de betonpoeren ruimte buiten de huidige mastvoeten; deze ruimte moet beschikbaar zijn. Daarnaast kunnen er vanuit de omgeving omstandigheden zijn waardoor aanvullende eisen van toepassing zijn aan het ontwerp, bijvoorbeeld de mogelijkheid van hoog water of de nabijheid van een dijklichaam of talud.

Een gedetailleerde studie naar eventuele obstakels direct naast de fundatie valt buiten de scope van deze rapportage. Uit een analyse van TenneT is gebleken dat er bij de steunmasten een locatie is waar mogelijk hoog water kan optreden, zie Tabel 10. Op het moment van schrijven is nog niet definitief bekend of de eisen voor hoogwater voor deze locatie zullen gelden. Het ontwerp van de fundatie voor deze locatie zal in een later stadium worden bepaald.

Tabel 11 Buitendijkse fundatie

Mastnummer	Gemeente	Masttype	Omgeving	Oplossingsvoorstel
1103	Moerdijk	S+9_c	Buitendijks	Verhoogde fundatie

2.12 Aarding

Uitwerking van aardingsvoorzieningen vallen buiten de scope van deze rapportage. In de UO-fase dient de aarding in de betonpoeren te worden ontworpen op basis van de van toepassing zijnde TenneT-specificaties.

2.13 Sterkte-coördinatie

TenneT stelt in PVE-lijnen 05.000 eisen aan sterkte-coördinatie tussen mast en fundaties. Dit is gebaseerd op IEC 60826. De daarin opgenomen eisen zijn toegelicht in de CIGRE brochure 178 "Probabilistic design of overhead lines". De ontwerpfilosofie moet zijn dat de fundatie met voldoende zekerheid niet mag falen voordat de mastconstructie faalt.

In de benadering met faalkansen wordt uitgegaan van gemiddelde sterktes en de 5% onderschrijdingskans. Voor fundaties geldt dat er een grote spreiding is in de sterkte als gevolg van het materiaal "grond". Om voldoende betrouwbaarheid te verkrijgen zijn fundaties daarom voor een gegeven vereiste sterkte ruim gedimensioneerd. Daardoor zal de gemiddelde sterkte van een fundatie ruimschoots de gemiddelde sterkte van de mastconstructie overstijgen, die een veel kleinere "extra" sterkte heeft. Bij een calamiteit is de kans op bezwijken van de fundatie voordat de mast bezwijkt dus gering.

Voor dit DO wordt ervan uitgegaan dat om te voldoen aan de eisen ten aanzien van sterkte-coördinatie een normale dimensionering van de fundaties voldoet, dat wil zeggen zonder overdimensionering. Vanwege de onvolledig beschikbare geotechnische gegevens wordt in het DO een maximale unity-check van 0,9 aangehouden.

2.14 Bijzondere ontwerpsituatie door ontgroning

In de rapportage uit het BO, rapport 19-0507 Advies knelpunten VKA 1.0, Meridiannummer 002.678.00 0678995, is bij een aantal mastlocaties sprake van de mogelijkheid van het ontstaan van een krater door het barsten van een ondergrondse hogedrukleiding. De stabiliteit van de fundatie kan hierdoor worden aangetast en de grond kan ontspannen als gevolg van de afgenomen belasting van de bovenste grondlagen op de diepere lagen waaraan draagkracht wordt ontleend.



In de rapportage 21-0507 is beschreven dat behalve in het bijzondere geval van een exploderende gasleiding de invloed van de ontgroning op de capaciteit zodanig klein is dat dit valt binnen de normale ontwerpmarges. De ontgroning valt onder de bijzondere belastingen met partiële factoren gelijk aan één en er is geen gelijktijdigheid van extreme windbelasting en tegelijk ontgroning. De stabiliteit van de paal is gezien de verhouding tussen diameter (ca. 0,6 m) en diepte van de krater (circa 3 m) niet in het geding.

3 FUNDERINGSONTWERP

3.1 Inleiding

Voor de steunmasten in de hoogspanningslijn is de enkelpaalsfundering met schroefinjectiepalen in de basis het uitgangspunt. Bij een tekort in draagvermogen bij de enkelpaalsfundering voor de steunmasten zal voor het DO een tweepaalsfundering worden gekozen. Als alternatief kan ook de geheide MV-paal als enkelpaalsfundering worden toegepast. Aangezien het streven van TenneT is om zoveel mogelijk enkelpaalsfunderingen toe te passen moet de mogelijkheid daarvan in de UO-fase worden onderzocht, waarbij ook het effect van heitrijvingen op de omgeving moet worden meegenomen. In het geval van bijzondere situaties, bijvoorbeeld als de fundatie zich bevindt in een wateroverloopgebied is een speciale, verhoogde fundatie het uitgangspunt.

3.2 Paaltypes

3.2.1 Schroefinjectiepaal

De schroefinjectiepaal als enkelpaalsfundering kan bij alle steunmasttypes worden toegepast, op voorwaarde dat met de bodemgesteldheid voldoende draagvermogen ontwikkeld kan worden. De paal is grondverdringend en wordt schroevend op diepte gebracht. De ruimte tussen schroefpunt en stalen buis wordt tijdens het inbrengen opgevuld met grout. Voor de maximale paallengte van de schroefinjectiepaal wordt op basis van referentieprojecten uitgegaan van 25 meter. De buispaal wordt over het in de poer opgenomen deel voorzien van een betonvulling. Onder het beton komt een zandvulling. Ingeval van bijzondere gevallen of agressieve gronden dient de betonvulling tot de paalpunt door te lopen.

3.2.2 MV-paal

De MV-paal is een geheide stalen buispaal met open punt. Met dit paalttype is een zeer hoog draagvermogen haalbaar. De detaillering van de paalkop is gelijk aan dat van de schroefinjectiepaal. Gebaseerd op de studie in de BO-fase wordt voor de mogelijk toe te passen diameter uitgegaan van 914 mm en van 1016 mm. Beiden gaan uit van een groutschil van 80 mm.

3.3 Enkelpaalsfundering

Eigenschappen van de enkelpaalsfundering:

- de funderingspaal wordt schoor aangebracht en heeft dezelfde helling en richting als de randstijl, de richting is naar buiten vanuit het centrum van de mast gezien, in de overhoekse richting. De schoorstand is in het verticale overhoekse vlak gelijk aan 1:4,71 (212 mm/m);
- de minimale afmeting is 610 mm voor het kunnen instorten van de randstijl rekening houdend met een paalafwijking van 0,1 m.
- de bovenkant van de paal bevindt zich op 0,5 m+ maaiveld. In uitzonderingsgevallen is dit 1,0 m;
- de paal wordt aan bovenzijde voorzien van gelaste blokdeuvels voor de krachtoverdracht met de ingestorte rand van de mastconstructie;
- de paal wordt over de bovenste circa 2,5 m voorzien van een betonvulling. De betonvulling moet met een afbolling worden gestort. Onder de beton komt een zandvulling. Ingeval van bijzondere gevallen of agressieve gronden dient de betonvulling tot paalpunt door te lopen;
- in de betonvulling wordt een spiraalwapening geplaatst;
- de randstijl wordt voor de aarding galvanisch verbonden met de wand van de paal via aangelaste stripjes;

In Figuur 3 is de principetekening opgenomen.

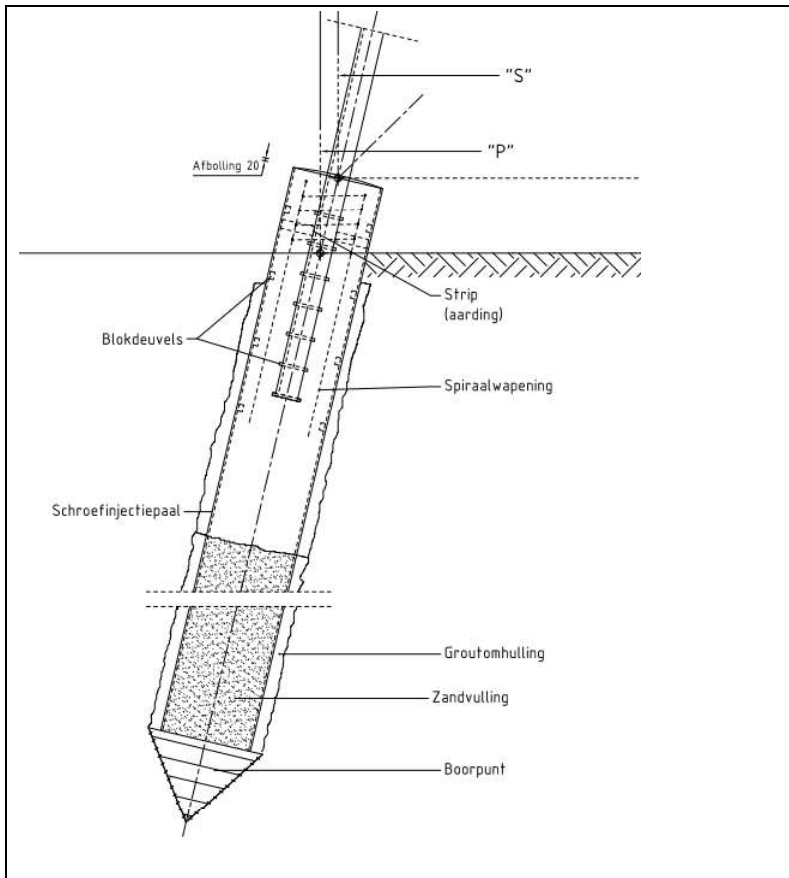

Figuur 3 Principe van de schroefinjectiepaal met ingestorte randstijl

3.4 Tweepaalsfundering

Bij onvoldoende draagvermogen wordt uitgegaan van de tweepaalsfundering. Hierbij worden twee palen opgenomen in een rechthoekige betonnen poer. Als paaltype is voor dit DO de schroefinjectiepaal het uitgangspunt omdat deze het breedst inzetbaar is. Als alternatief kan in het UO ook een vibro-paal of FGI-paal worden toegepast. Voor de beschrijving van deze palen wordt verwezen naar rapportage 21-1250 van de hoekmasten, Meridannummer 002.678.00 0950632.

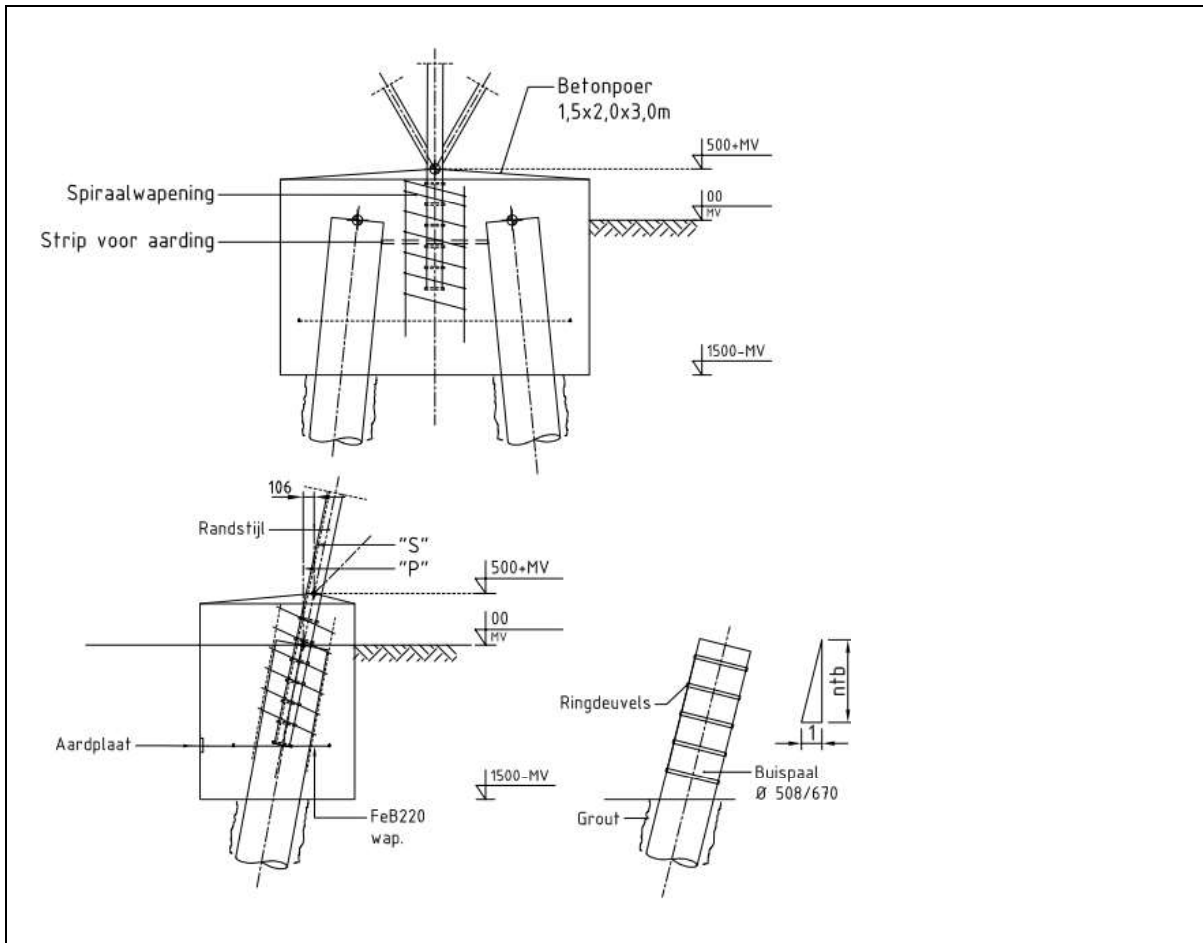

Figuur 4 Principe van de tweepaalsfundering

3.5 Verhoogde fundering

Mast 1012 en 1013 dienen een verhoogde fundering te bezitten, om voldoende afstand tot een wegbuis te verkrijgen zonder dat een hoger masttype benodigd is, omdat dat bezwaarlijk is vanuit de nabijheid tot de vliegbasis Woensdrecht. De oplossing bestaat uit het toepassen van een enkelpaalsfundering met bovenkant fundatie op 1,0 m boven maaiveld in plaats van 0,5 m boven maaiveld.

Bij mast 1103 zal de fundatie verhoogd worden uitgevoerd vanwege de buitendijkse locatie. Op deze locatie is een tweepaalspoer voorzien, deze zal een betonnen opstorting krijgen zodat de mastconstructie bij hoogwater boven het waterpeil blijft.

4 AANPAK

4.1 Inleiding

Voor alle mastlocaties in het tracé zal uitgaande van de beschikbare sonderingsgegevens het poertype en de paallengte indicatief worden bepaald. De berekening wordt uitgevoerd met de software TS/paalfunderingen. De toetsing vindt plaats ten aanzien van trek- en drukbelasting.

In deze DO-rapportage zal de enkelpaalsfundering worden getoetst met de grootste horizontale belastingen binnen de groep van steunmasttypes waar dit fundatietype wordt toegepast. Het gaat om alle steunmasttypes met uitzondering van S+12/c, S+18/s en S+24/s. Er zal worden uitgegaan van het slechtste bodemprofiel over de lengte van het tracé.

4.2 Belasting

De fundatiebelastingen van de mastconstructies zijn opgenomen in Appendix A. Deze zijn ontleend aan de uitvoer vanuit PLS-TOWER. Dit wijkt af van de uitvoer van de oplegreacties van de mastrapporten. Daarin is gebruik gemaakt van de uitvoer van het programma Geleiderbelastingen. Er is gekozen voor gebruik van de reacties vanuit het 3D-model van PLS-TOWER omdat hierin de werkelijke afdracht van horizontale belastingen gevonden wordt.

Voor de toetsing met TS/paalfunderingen wordt gebruik gemaakt van de belasting in de richting van de randstijl (lokale richting) voor trek- en drukbelasting.

De belastingcombinaties die in het DO worden gehanteerd voor de berekening van de horizontale afdracht bestaat uit de volgende belastingen, alle voor de uiterste grenstoestand. De belastingen gelden voor één van de vier hoekpunten.

- maximale drukbelasting, in deze combinatie belast de randstijl de fundatie met een neerwaartse kracht en een horizontale kracht naar buiten;
- maximale trekbelasting, in deze combinatie belast de randstijl de fundatie met een opwaarts gerichte kracht en een horizontale kracht naar binnen;
- maximale torsiebelasting, hierbij wordt de fundatie haaks op de diagonale richting van het grondvlak belast. De positieve en negatieve horizontale richting wordt onderzocht. De verticale belasting kan van ondergeschikte grootte zijn.
- maximale combinatie van trekbelasting en torsie. Bij een meerpaalspoer leidt de horizontale kracht door torsie tot een vergroting van de trekkracht. In combinatie met een eveneens significante trekkracht vanuit de mast kan dit maatgevend zijn voor een van de palen in de fundatie. Zie hiervoor de toelichting in Appendix C.

4.3 Draagvermogen

Vanuit het geotechnisch lengteprofiel is een representatieve selectie gemaakt waarmee berekeningen zijn uitgevoerd. Bovendien is zoveel mogelijk gebruik gemaakt van sonderingen met een diepte van meer dan 30 meter, omdat paallengtes tot 25 m oplopen. Het lengteprofiel is verdeeld in 15 deeltrajecten. Per deeltrajecten is één sondering gekozen. In tabel zijn de in de berekening gebruikte sonderingen gegeven. De berekeningen zijn voor alle paaltypes bij iedere sondering uitgevoerd.

Tabel 12 Gebruikte sonderingen

CPT bestand	type	RD_x_sond	RD_y_sond	RD_m_sond	sondeerlengte	gemeente
2019-1008_1.GEF	GEF	75341,2	382565,9	2,12	34,824	Reimerswaal
2019-1008_6.GEF	GEF	81608,3	388586,3	11	34,928	Bergen op Zoom
02P001595_166.S01.GEF	GEF	87819,8	393422,8	3,45	26,107	Roosendaal
2019-1008_11.GEF	GEF	90949,4	398218,9	0,62	34,898	Halderberge
2019-1008_12.GEF	GEF	92691,7	399690,8	3,57	35,066	Halderberge

2019-1008_17.GEF	GEF	96097,9	405288,6	0,2	34,998	Moerdijk
2019-1008_20.GEF	GEF	99890,2	408354,7	-0,03	35,203	Moerdijk
2019-1008_21.GEF	GEF	102678,6	409201,9	1,78	34,974	Moerdijk
02P001595_251.S01.GEF	GEF	109537,3	411798	-1,05	39,831	Drimmelen
2019-1008_29.GEF	GEF	114349,2	411937,4	0,79	35,076	Drimmelen
02P001595_283.S02.GEF	GEF	119023,6	409980,1	0,17	32,463	Geertruidenberg
2019-1008_35.GEF	GEF	123777,2	408715	0,92	35,167	Dongen
02P001595_312.S03.GEF	GEF	127922,2	405557,3	3,78	35,751	Loon op Zand
2019-1008_43.GEF	GEF	131482,8	403215,2	9,88	35,044	Loon op Zand
02P001595_328.S02.GEF	GEF	132052,7	402297,2	10,171	39,063	Tilburg

De sonderingen zijn in digitaal formaat (gef-bestand) ingelezen in het programma Technosoft Paalfunderingen. Aan de hand van de sonderingen en de beschikbare boringen is een grondprofiel geconstrueerd. De gebieden waarin negatieve en positieve schachtwrijving optreedt worden ingesteld per sondering.

Bij de invoer in het programma is rekening gehouden met de situatie dat de berekeningen niet voor één locatie worden uitgevoerd, maar voor een geheel van locaties. Omdat er grote verschillen in maaiveldniveau zijn tussen de sonderingen zijn deze in drie groepen verdeeld; sonderingen waarbij de paalkop zich bevindt op 0.0+, 3.6+ en 10.5+ N.A.P. Met deze onderverdeling wordt bereikt dat de juiste positieve en negatieve kleeft wordt berekend, in het programma wordt geen kleeft toegekend aan het deel van de paal dat uitsteekt boven het (fictieve) maaiveld. Daarnaast is per mast de werkelijke maaiveldhoogte aldaar gebruikt om de limiet van 25 m paallengte zo veel mogelijk niet te overschrijden, hooguit op een paar decimeter na.

Aanvullend op de berekening in Technosoft is een controle op het kluitgewicht uitgevoerd volgens art. 7.6.3.3 (g) van NEN-EN 1997-1, waaruit de minimale lengte voor voldoende te mobiliseren grondmassa volgt.

Geotechnische berekeningen zijn opgenomen in Appendix D. In de uitvoer zijn van toepassing zijnde paalpuntniveau's omkaderd.

4.4 Horizontale krachtafdracht

4.4.1 Krachtsverdeling

Met een staafwerkmodel in het programma AxisVM is de horizontale krachtafdracht berekend. De palen zijn als elastisch ondersteunde liggers zijn ingevoerd. Er wordt geen steun uit de grond tussen maaiveld en 1 m onder maaiveld of tegen de poeren gerekend, alsof de fundaties grenzen aan een waterloop. De horizontale gronddruk is begrensd tot de passieve gronddruk die kan worden ontwikkeld.

De berekening voor de horizontale krachtafdracht is uitgevoerd uitgaande van het maatgevende bodemprofiel over de lengte van het tracé. Dat wil zeggen voor één van de sonderingen. Als maatgevend is het bodemprofiel van sondering 2019-1008-017 gehanteerd. Hierbij zijn vanaf maaiveld tot circa 10 m diepte kleilagen aanwezig die minder steun verlenen dan zandlagen.

Het kan zijn dat een tweepaalspoer te maken krijgt met herverdeling van belasting (bijv. door verkeerd heien of inmeten). Dit is meegenomen in de controle van de palen op trek- en drukbelasting via de factor "efficiëntie", zie de tabel in Appendix C. Voor een tweepaalspoer is gerekend met 95%. De palen in deze poer kunnen 5% meer belasting opnemen. De éénpaalspoer kan niet herverdelen en de factor is daarom 100%. Er wordt een maximale unity-check van 0,9 aangehouden.

De berekening van de horizontale afdracht verschaft informatie over de combinatie van axiale krachten en buiging in de paalschacht. De aldus gevonden spanningen worden gebruikt in de toetsing van de doorsnede van de buispaal. De éénpaalsfundering is gekozen om te toetsen, deze heeft vanwege de vrijstaande paalkop de grootste horizontale belasting. De berekening is opgenomen in Appendix E.

4.4.2 Horizontale verplaatsing

De TenneT-specificatie "Paalfunderingen" stelt eisen aan de maximale onderlinge verplaatsing van de fundatie bij de randstijl. Deze mag niet meer bedragen dan $1/400 b$. Verplaatsingseisen worden gesteld voor de karakteristieke belastingen, zonder belastingfactoren. In Appendix C is verdere invulling gegeven aan deze eis.

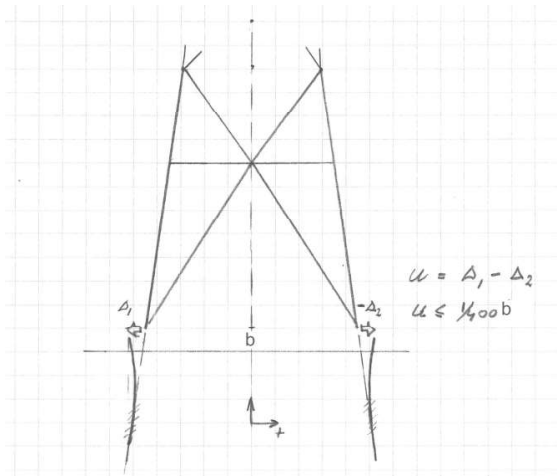

Figuur 5 Eis aan de horizontale verplaatsing

4.5 Wapening

Het detailleren van de wapening in de paal(kop) valt buiten de scope van dit rapport. De benodigde wapening is in de UO-fase door opdrachtnemer te bepalen. In Figuur 6 is het principe van de wapening weergegeven.

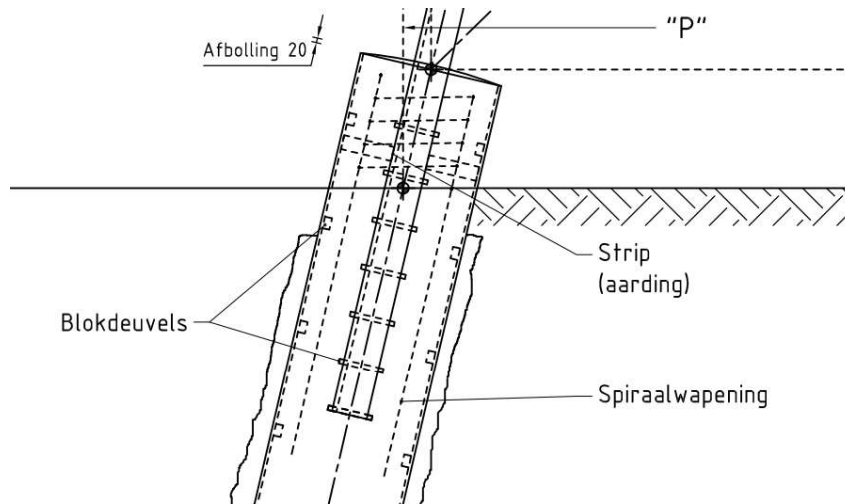

Figuur 6 Principe van de wapening

Als indicatie kan worden uitgegaan van een splijtwapening uitgevoerd in spiraalwapening. De doorsnede van de splijtwapening wordt bepaald op basis van de drukdiagonalen die vanuit de blokdeuvels ontstaan. De afdracht vindt verdeeld plaats over de ingestorte lengte. De grootste trekbelasting treedt op bij mast S+18_s. en bedraagt $F = 1750$ kN. Uitgaande van een drukdiagonaal van 45° is de trekkracht in de beugels gelijk aan $1750 / 2 = 875$ kN. Bij een ingestorte lengte van 1,5 m en twee effectieve doorsnedes aan weerszijden van het staalprofiel is de verdeelde reactie per doorsnede gelijk aan $875 / (1,5 \times 2) = 292$ kN/m. Uitgaande van een toelaatbare spanning van 435 N/mm^2 in het



wapeningsstaal is de benodigde wapeningsdoorsnede $292 / 0,435 = 671 \text{ mm}^2/\text{m}$. Indicatieve keuze $\text{Ø}10\text{-}100$ (785 mm^2) voldoet.

De verticale wapening wordt gebaseerd op het mogelijk uitbreken van de bovenste betonkegel. Vanwege de voetplaat en de rechtstreekse afdracht van de blokdeuvels wordt uitgegaan van een trekkracht van een kwart van de totale trekkracht. $F = 1/4 \times 1750 \text{ kN} = 440 \text{ kN}$. Een wapeningsdoorsnede van $440 / 0,435 = 1011 \text{ mm}^2$ voldoet. Keuze: 4 haarspelden $\text{Ø}16$: $2 \times 4 \times 201 \text{ mm}^2 = 1608 \text{ mm}^2$.

5 RESULTATEN

5.1 Verticaal draagvermogen

De resultaten van de berekeningen zijn samengevat in Appendix D. Voor alle van toepassing zijnde locaties is de toetsing uitgedrukt in de Unity-Check. De toetsing voor trek en druk is opgenomen. Alle Unity-Checks zijn kleiner dan 0,9, dus voldoen de fundaties aan het gestelde uitgangspunt. De paallengte is groter dan de minimale lengte benodigd voor het kluitgewicht.

In Tabel 12 is per sondering weergegeven in hoeverre de enkelpaalsfundering toepasbaar is. In een aantal gevallen is voor een tweepaalspoer gekozen als alternatief. Voor masttypes S+12/c, S+18/s, S+24/s is een tweepaalsfundering het uitgangspunt in het DO. Dit uitgangspunt staat niet in tabel 12 omdat deze keuze onafhankelijk is van de sonderingen.

Tabel 13 Resultaat per sondering

CPT bestand	Gemeente	Bijzonderheden
2019-1008_1.GEF	Reimerswaal	Trek maatgevend, alleen paaldiameter 610 mm toegepast.
2019-1008_6.GEF	Bergen op Zoom	Trek maatgevend, alleen paaldiameter 610 mm toegepast.
02P001595_166.S01.GEF	Roosendaal	Trek maatgevend, paaldiameter 762 mm ook toegepast.
2019-1008_11.GEF	Halderberge	Trek maatgevend, paaldiameter 762 mm ook toegepast.
2019-1008_12.GEF	Halderberge	Trek maatgevend, paaldiameter 762 mm ook toegepast.
2019-1008_17.GEF	Moerdijk	Trek maatgevend, alleen paaldiameter 610 mm en tweepaalspoer toegepast.
2019-1008_20.GEF	Moerdijk	Trek maatgevend, alleen tweepaalspoer toegepast.
2019-1008_21.GEF	Moerdijk	Trek en druk maatgevend. alleen paaldiameter 762 mm en tweepaalspoer toegepast.
02P001595_251.S01.GEF	Drimmelen	Trek maatgevend, alleen paaldiameter 610 mm toegepast.
2019-1008_29.GEF	Drimmelen	Trek maatgevend, alleen paaldiameter 610 mm toegepast.
02P001595_283.S02.GEF	Geertruidenberg	Trek maatgevend, alleen paaldiameter 610 mm toegepast.
2019-1008_35.GEF	Dongen	Trek maatgevend, alleen paaldiameter 610 mm toegepast.
02P001595_312.S03.GEF	Loon op Zand	Trek maatgevend, alleen paaldiameter 610 mm toegepast.
2019-1008_43.GEF	Loon op Zand	Trek maatgevend, alleen paaldiameter 610 mm toegepast.
02P001595_328.S02.GEF	Tilburg	Geen steunmasten

5.2 Horizontale krachtsafdracht

In Appendix E is het resultaat beschreven van de horizontale krachtsafdracht. Uit Tabel 13 blijkt dat de toetsing van de spanning in de buispaal en de horizontale verplaatsing voldoet. Voor masttypes S+12/c, S+18/s, S+24/s is een tweepaalsfundering het uitgangspunt in het DO vanwege de grootte van de horizontale spatkracht. In het UO kan nader bepaald worden of hier een enkelpaalsfundering mogelijk is. Dit uitgangspunt is niet verwerkt in tabel 12.

Tabel 14 Toetsing horizontale krachtsafdracht

	Berekend	Toelaatbaar	Unity-check
Spanningscheck buispaal	121	355 N/mm ²	0,34 OK
Verplaatsing ULS-1a ex/ey	15,4	17,3 mm	0,89 OK
Verplaatsing ULS-5a ex/ey	20,8	25,6 mm	0,81 OK

5.3 Hoeveelheden

In Tabel 14 is als samenvatting het aantal palen, de lengte en maximale lengte opgenomen. Dit is gebaseerd op de resultaten per locatie volgens Appendix B.

Tabel 15 Hoeveelheden

Paaltype	Aantal locaties	Aantal palen	Gem. paallengte (m)	Max. paallengte (m)
SI Ø610/850	104	416	21,4	25,2
SI Ø762/950	10	40	23,5	24,3
SI Ø508/670 ⁶	20	160	19,7	23,7

⁶ onderdeel van tweepaalsfundering

APPENDIX A

Fundatiebelastingen

De reacties van de mastconstructie op de fundering worden in deze appendix gepresenteerd. Het gaat om de maatgevende waarden per masttype van de druk-, trek- en horizontale reacties. Vanwege de oriëntatie van de funderingspaal, zijn de waarden beschreven in de X-, Y-, en Z-coördinaat van het globale assenstelsel en in het lokale assenstelsel van de randstijl ("leg direction"). De gegeven waarden zijn een samenvatting over alle berekende belastingcombinaties en zijn gebaseerd op de grootste waarden van elk van de vier fundatiepunten van de mast. De reacties zijn ontleend aan de berekening van PLS-TOWER, dit wijkt af van de mastrapportages waarin uitvoer vanuit het programma "geleiderbelastingen" is opgenomen.

De twee belangrijkste waarden van de funderingsreacties worden gevormd door de trek- en de drukkracht vanuit de randstijl. In geval van een drukkracht zal gezien in het *globale* assenstelsel bij een hellende randstijl een naar buiten gerichte horizontale kracht werken, zie Figuur 6. In geval van een trekkracht in de randstijl is de horizontale component naar binnen gericht.

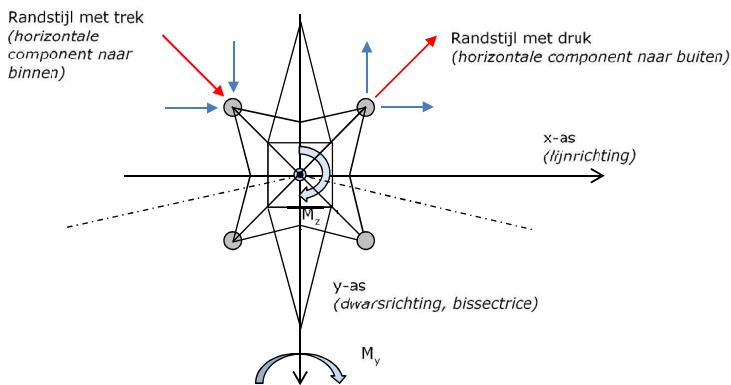

Figuur 7 Belasting bij maximale trek- of drukbelasting vanuit de mast

In het geval van torsiebelasting op de mast, bij steunmasten is dat onder de combinatie 5a (geleiderbreuk), bij hoekmasten door de afwezigheid van geleiders aan één zijde van de mast (special limit state), werkt er een significante horizontale kracht op de fundering *haaks* op de richting van de randstijl. Voor de berekening van de horizontale krachtsafdracht van de fundering moet met de belasting door torsie rekening worden gehouden.

In tegenstelling tot de horizontaalkracht bij maximale verticale druk- of trekkracht, is de horizontale belasting door torsie niet gerelateerd aan de trek- of drukkracht in de randstijl. Op de bladzijde "max. trekbelasting en torsie" zijn de combinaties opgezocht waarbij zowel een grote trekkracht optreedt als een horizontale kracht door torsie.

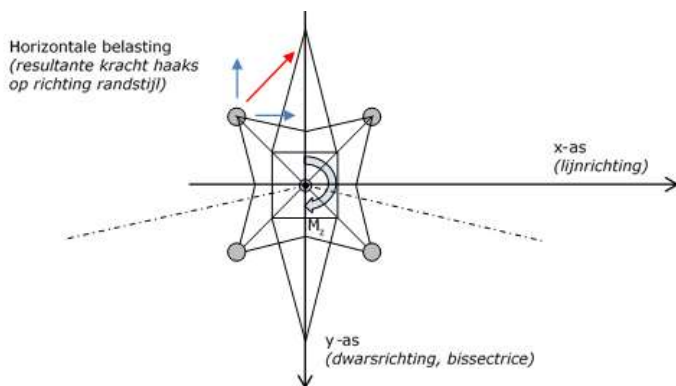

Figuur 8 Belasting bij torsiebelasting vanuit de mast

Belastingen op de fundatie in het lokale coördinatenstelsel zijn uitgedrukt in de radiale en tangentiële richting eta en xi, zie Figuur 8.

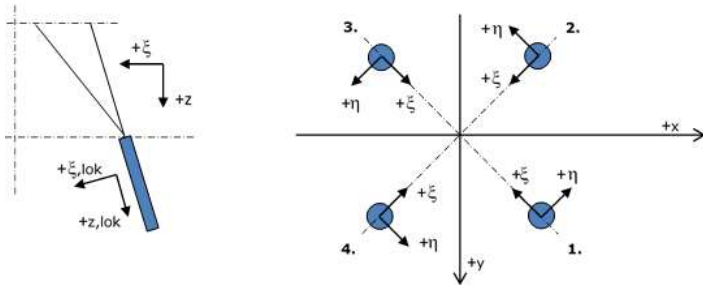

Figuur 9 Lokaal assenstelsel



Project: **RLL-TLB**
Uitgangspunt: **Nieuwbouw**
Datum: **14-10-2021**

Betreft: **Trekbelasting**
Richting: **Globale assenstelsel**

	Mastnummer	Masttype	Verticaal trek [kN]	X-richting [kN]	Y-richting [kN]	Betrouwbaarheidsniveau	Bijbehorende loadcase
1011	S-3_s		1108,0	167,0	-162,1	Nieuwbouw CC2	ULS 1a_0,9_0,9_135
1064	S+0_s		1214,2	180,7	-174,2	Nieuwbouw CC2	ULS 1a_0,9_0,9_135
0	S+3_s		1322,0	194,4	-186,0	Nieuwbouw CC2	ULS 1a_0,9_0,9_135
1059	S+6_s		1103,0	169,6	-161,1	Nieuwbouw CC2	ULS 1a_0,9_0,9_135
1057	S+9_s		1125,9	172,5	-164,9	Nieuwbouw CC2	ULS 1a_0,9_0,9_135
1003	S+18_s		1703,7	295,8	-275,5	Nieuwbouw CC2	ULS 1a_0,9_0,9_135
1149	S+24_s		1463,7	253,6	-239,8	Nieuwbouw CC2	ULS 1a_0,9_0,9_135
1119	S-3_c		1215,3	183,2	-160,5	Nieuwbouw CC2	ULS 1a_0,9_0,9_90
1111	S+0_c		1307,1	206,5	-163,4	Nieuwbouw CC2	ULS 1a_0,9_0,9_90
1104	S+3_c		1433,5	222,3	-175,0	Nieuwbouw CC2	ULS 1a_0,9_0,9_90
1101	S+6_c		1449,7	220,3	-206,9	Nieuwbouw CC2	ULS 1a_0,9_0,9_135
1073	S+9_c		1464,5	218,6	-207,9	Nieuwbouw CC2	ULS 1a_0,9_0,9_135
1077	S+12_c		1539,5	267,0	-247,8	Nieuwbouw CC2	ULS 1a_0,9_0,9_135



Project: **RLL-TLB**
Uitgangspunt: **Nieuwbouw**
Datum: **14-10-2021**

Betreft: **Drukbelasting**
Richting: **Globale assenstelsel**

Mastnummer	Masttype	Verticaal druk [kN]	X-richting [kN]	Y-richting [kN]	Betrouwbaarheidsniveau	Bijbehorende loadcase
1011	S-3_s	-1383,5	-206,4	-206,8	Nieuwbouw CC2	ULS 1a_45
1064	S+0_s	-1499,3	-221,7	-220,5	Nieuwbouw CC2	ULS 1a_45
0	S+3_s	-1614,9	-236,4	-233,8	Nieuwbouw CC2	ULS 1a_45
1059	S+6_s	-1412,5	-217,1	-212,7	Nieuwbouw CC2	ULS 1a_45
1057	S+9_s	-1460,8	227,0	-223,2	Nieuwbouw CC2	ULS 1a_135
1003	S+18_s	-2109,5	-369,9	-353,6	Nieuwbouw CC2	ULS 1a_45
1149	S+24_s	-1918,4	-328,5	-317,2	Nieuwbouw CC2	ULS 1a_45
1119	S-3_c	-1593,8	-237,3	-235,6	Nieuwbouw CC2	ULS 1a_45
1111	S+0_c	-1704,8	-257,8	-251,9	Nieuwbouw CC2	ULS 1a_45
1104	S+3_c	-1838,2	-274,1	-266,7	Nieuwbouw CC2	ULS 1a_45
1101	S+6_c	-1868,1	-283,9	-276,4	Nieuwbouw CC2	ULS 1a_45
1073	S+9_c	-1913,0	-288,1	-282,9	Nieuwbouw CC2	ULS 1a_45
1077	S+12_c	-2035,5	-355,8	-340,4	Nieuwbouw CC2	ULS 1a_45



Project: **RLL-TLB**
 Uitgangspunt: **Nieuwbouw**
 Datum: **14-10-2021**

Betreft: **Trekbelasting**
 Richting: **Lokale assenstelsel**

Mastnummer	Masttype	Verticaal trek [kN]	X(-)richting [kN]	Eta-richting [kN]	Betrouwbaarheidsniveau	Bijbehorende loadcase
1011	S-3_s	1132.2	2.3	3.4	Nieuwbouw CC2	ULS 1a_0,9_0,9_135
1064	S+0_s	1239.8	6,6	4,6	Nieuwbouw CC2	ULS 1a_0,9_0,9_135
0	S+3_s	1349.1	11.5	5.9	Nieuwbouw CC2	ULS 1a_0,9_0,9_135
1059	S+6_s	1127.5	0.2	6.0	Nieuwbouw CC2	ULS 1a_0,9_0,9_135
1057	S+9_s	1150.9	0.3	5.3	Nieuwbouw CC2	ULS 1a_0,9_0,9_135
1003	S+18_s	1750.4	-42.6	14.4	Nieuwbouw CC2	ULS 1a_0,9_0,9_135
1149	S+24_s	1504.2	-38.4	9.8	Nieuwbouw CC2	ULS 1a_0,9_0,9_135
1119	S-3_c	1239.3	14,7	16,1	Nieuwbouw CC2	ULS 1a_0,9_0,9_90
1111	S+0_c	1332.9	15,7	30,5	Nieuwbouw CC2	ULS 1a_0,9_0,9_90
1104	S+3_c	1460.6	23,2	33,4	Nieuwbouw CC2	ULS 1a_0,9_0,9_90
1101	S+6_c	1480.8	5,4	9,5	Nieuwbouw CC2	ULS 1a_0,9_0,9_135
1073	S+9_c	1495.2	9,1	7,6	Nieuwbouw CC2	ULS 1a_0,9_0,9_135
1077	S+12_c	1581.5	-37.4	13.6	Nieuwbouw CC2	ULS 1a_0,9_0,9_135



Project: **RLL-TLB**
 Uitgangspunt: **Nieuwbouw**
 Datum: **14-10-2021**

Betreft: **Drukbelasting**
 Richting: **Lokale assenstelsel**

Mastnummer	Masttype	Verticaal druk [kN]	X(-)richting [kN]	Eta-richting [kN]	Betrouwbaarheidsniveau	Bijbehorende loadcase
1011	S-3_s	-1414,0	-1,3	-0,3	Nieuwbouw CC2	ULS 1a_45
1064	S+0_s	-1531,6	-5,4	0,9	Nieuwbouw CC2	ULS 1a_45
0	S+3_s	-1648,7	-10,1	1,8	Nieuwbouw CC2	ULS 1a_45
1059	S+6_s	-1444,8	4,3	3,1	Nieuwbouw CC2	ULS 1a_45
1057	S+9_s	-1495,1	8,4	-2,7	Nieuwbouw CC2	ULS 1a_135
1003	S+18_s	-2169,7	64,1	11,5	Nieuwbouw CC2	ULS 1a_45
1149	S+24_s	-1971,4	49,6	8,0	Nieuwbouw CC2	ULS 1a_45
1119	S-3_c	-1628,5	-3,7	1,2	Nieuwbouw CC2	ULS 1a_45
1111	S+0_c	-1742,5	-1,2	4,1	Nieuwbouw CC2	ULS 1a_45
1104	S+3_c	-1877,6	-7,6	5,3	Nieuwbouw CC2	ULS 1a_45
1101	S+6_c	-1909,7	-0,1	5,3	Nieuwbouw CC2	ULS 1a_45
1073	S+9_c	-1955,1	-2,0	3,7	Nieuwbouw CC2	ULS 1a_45
1077	S+12_c	-2093,3	60,5	10,9	Nieuwbouw CC2	ULS 1a_45



Project: **RLL-TLB**
 Uitgangspunt: **Nieuwbouw**
 Datum: **14-10-2021**

Betreft: **Torsiebelasting positief**
 Richting: **Lokale assenstelsel**

Mastnummer	Masttype	Verticaal [kN]	Xi-richting [kN]	Eta-richting [kN]	Betrouwbaarheidsniveau	Bijbehorende loadcase
1011	S-3_s	-232.9	-0.1	46.7	Nieuwbouw CC2	ULS 8 Ba_bouwfase
1064	S+0_s	-235.8	-0.9	46.9	Nieuwbouw CC2	ULS 8 Ba_bouwfase
0	S+3_s	-246.9	-2.3	46.6	Nieuwbouw CC2	ULS 8 Ba_bouwfase
1059	S+6_s	-246.1	-0.5	44.4	Nieuwbouw CC2	ULS 8 Ba_bouwfase
1057	S+9_s	-327.2	4.2	38.6	Nieuwbouw CC2	ULS 5a Ah 11_bouwfase
1003	S+18_s	1535.0	-19.2	49.0	Nieuwbouw CC2	ULS 1a_0,9_0,9_90
1149	S+24_s	-391.6	5.6	36.4	Nieuwbouw CC2	ULS 5a Ah 11_bouwfase(24)
1119	S-3_c	-340.6	0.9	59.3	Nieuwbouw CC2	ULS 5a Ah 11_bouwfase
1111	S+0_c	-357.7	2.1	60.0	Nieuwbouw CC2	ULS 5a Ah 11_bouwfase
1104	S+3_c	-371.9	0.5	59.0	Nieuwbouw CC2	ULS 5a Ah 11_bouwfase
1101	S+6_c	-376.0	1.7	54.5	Nieuwbouw CC2	ULS 5a Ah 11_bouwfase
1073	S+9_c	-382.8	2.8	50.0	Nieuwbouw CC2	ULS 5a Ah 11_bouwfase
1077	S+12_c	-357.0	15.9	59.0	Nieuwbouw CC2	ULS 5a Ah 11_bouwfase



Project: **RLL-TLB**
 Uitgangspunt: **Nieuwbouw**
 Datum: **14-10-2021**

Betreft: **Torsiebelasting negatief**
 Richting: **Lokale assenstelsel**

Mastnummer	Masttype	Verticaal [kN]	Xi-richting [kN]	Eta-richting [kN]	Betrouwbaarheidsniveau	Bijbehorende loadcase
1011	S-3_s	-232.9	-0.1	-46.7	Nieuwbouw CC2	ULS 8 Ah_bouwfase
1064	S+0_s	-235.8	-0.9	-46.9	Nieuwbouw CC2	ULS 8 Ah_bouwfase
0	S+3_s	-246.9	-2.3	-46.6	Nieuwbouw CC2	ULS 8 Ah_bouwfase
1059	S+6_s	-246.1	-0.5	-44.4	Nieuwbouw CC2	ULS 8 Ah_bouwfase
1057	S+9_s	-327.2	4.2	-38.6	Nieuwbouw CC2	ULS 5a Ba 11_bouwfase
1003	S+18_s	1535.0	-19.2	-49.0	Nieuwbouw CC2	ULS 1a_0,9_0,9_90
1149	S+24_s	-392.0	5.4	-36.1	Nieuwbouw CC2	ULS 5a Ba 11_bouwfase(24)
1119	S-3_c	-340.6	0.9	-59.3	Nieuwbouw CC2	ULS 5a Ba 11_bouwfase
1111	S+0_c	-357.7	2.1	-60.0	Nieuwbouw CC2	ULS 5a Ba 11_bouwfase
1104	S+3_c	-371.9	0.5	-59.0	Nieuwbouw CC2	ULS 5a Ba 11_bouwfase
1101	S+6_c	-376.0	1.7	-54.5	Nieuwbouw CC2	ULS 5a Ba 11_bouwfase
1073	S+9_c	-382.8	2.8	-50.0	Nieuwbouw CC2	ULS 5a Ba 11_bouwfase
1077	S+12_c	-357.0	15.9	-59.0	Nieuwbouw CC2	ULS 5a Ba 11_bouwfase



Project: **RLL-TLB**
Uitgangspunt: **Nieuwbouw**
Datum: **14-10-2021**

Betreft **Max. trekbelasting + torsie**
Richting **Lokale assenstelsel**

Mastnummer	Masttype	Verticaal [kN]	X(-)richting [kN]	Eta-richting [kN]	Betrouwbaarheidsniveau	Bijbehorende loadcase
1011	S-3_s	1132.2	2.3	3.4	Nieuwbouw CC2	ULS 1a_0,9_0,9_135
1064	S+0_s	1239.8	6,6	4,6	Nieuwbouw CC2	ULS 1a_0,9_0,9_135
0	S+3_s	1349.1	11.5	5.9	Nieuwbouw CC2	ULS 1a_0,9_0,9_135
1059	S+6_s	1081.2	12.3	15.1	Nieuwbouw CC2	ULS 1a_0,9_0,9_90
1057	S+9_s	1150.9	0.3	5.3	Nieuwbouw CC2	ULS 1a_0,9_0,9_135
1003	S+18_s	1535.0	-19.2	49.0	Nieuwbouw CC2	ULS 1a_0,9_0,9_90
1149	S+24_s	1504.2	-38.4	9.8	Nieuwbouw CC2	ULS 1a_0,9_0,9_135
1119	S-3_c	1239.3	14,7	16,1	Nieuwbouw CC2	ULS 1a_0,9_0,9_90
1111	S+0_c	1332.9	15,7	30,5	Nieuwbouw CC2	ULS 1a_0,9_0,9_90
1104	S+3_c	1460.6	23,2	33,4	Nieuwbouw CC2	ULS 1a_0,9_0,9_90
1101	S+6_c	1474.0	17,8	32,2	Nieuwbouw CC2	ULS 1a_0,9_0,9_90
1073	S+9_c	1468.0	20,8	22,8	Nieuwbouw CC2	ULS 1a_0,9_0,9_90
1077	S+12_c	1498.6	-19.0	47.1	Nieuwbouw CC2	ULS 1a_0,9_0,9_90

APPENDIX B

Fundatiegegevens

Paalgegevens											
Mastnr.	Masttype	Aantal palen	Paaltype	Paallengte [m]	Paal boven maaiveld [m]	Paalpuntniveau t.o.v. MV [m]	Maaiveld t.o.v. NAP [m]	Bovenkant fundatie t.o.v. NAP [m]	Paal tov. bk. fundatie [m]	Paalpuntniveau t.o.v. NAP [m]	
1003	S+18_s	2	SI Ø508/670	22,85	0,00	-22,85	1,35	1,85	0,50	-21,50	
1004	S+18_s	2	SI Ø508/670	23,01	0,00	-23,01	1,51	2,01	0,50	-21,50	
1006	S+0_s	1	SI Ø610/850	24,58	0,50	-24,08	1,08	1,58	0,00	-23,00	
1008	S+0_s	1	SI Ø610/850	24,80	0,50	-24,30	1,30	1,80	0,00	-23,00	
1009	S+0_s	1	SI Ø610/850	25,16	0,50	-24,66	1,66	2,16	0,00	-23,00	
1010	S+0_s	1	SI Ø610/850	24,88	0,50	-24,38	1,38	1,88	0,00	-23,00	
1011	S-3_s	1	SI Ø610/850	23,93	0,50	-23,43	1,43	1,93	0,00	-22,00	
1012	S-3_s	1	SI Ø610/850	24,71	1,00	-23,71	1,71	2,71	0,00	-22,00	
1013	S-3_s	1	SI Ø610/850	24,27	1,00	-23,27	1,27	2,27	0,00	-22,00	
1026	S-3_c	1	SI Ø610/850	16,63	0,50	-16,13	7,63	8,13	0,00	-8,50	
1028	S+0_c	1	SI Ø610/850	18,70	0,50	-18,20	8,70	9,20	0,00	-9,50	
1029	S+6_c	1	SI Ø610/850	17,27	0,50	-16,77	7,27	7,77	0,00	-9,50	
1030	S+3_c	1	SI Ø610/850	19,65	0,50	-19,15	8,65	9,15	0,00	-10,50	
1031	S+0_c	1	SI Ø610/850	17,30	0,50	-16,80	7,30	7,80	0,00	-9,50	
1032	S+3_c	1	SI Ø610/850	21,55	0,50	-21,05	4,55	5,05	0,00	-16,50	
1034	S+0_c	1	SI Ø610/850	22,25	0,50	-21,75	6,75	7,25	0,00	-15,00	
1035	S+0_c	1	SI Ø610/850	24,04	0,50	-23,54	8,54	9,04	0,00	-15,00	
1036	S+3_c	1	SI Ø762/950	23,49	0,50	-22,99	8,99	9,49	0,00	-14,00	
1038	S+0_c	1	SI Ø610/850	22,54	0,50	-22,04	7,04	7,54	0,00	-15,00	
1039	S+3_c	1	SI Ø610/850	23,33	0,50	-22,83	6,33	6,83	0,00	-16,50	
1040	S+3_c	1	SI Ø610/850	21,81	0,50	-21,31	4,81	5,31	0,00	-16,50	
1041	S+0_c	1	SI Ø610/850	19,66	0,50	-19,16	4,16	4,66	0,00	-15,00	
1042	S+0_c	1	SI Ø610/850	19,77	0,50	-19,27	4,27	4,77	0,00	-15,00	
1043	S+3_c	1	SI Ø610/850	21,49	0,50	-20,99	4,49	4,99	0,00	-16,50	
1045	S+0_c	1	SI Ø610/850	18,89	0,50	-18,39	3,39	3,89	0,00	-15,00	
1046	S+0_c	1	SI Ø610/850	18,01	0,50	-17,51	2,51	3,01	0,00	-15,00	
1047	S+0_c	1	SI Ø762/950	23,50	0,50	-23,00	2,50	3,00	0,00	-20,50	
1048	S+0_c	1	SI Ø610/850	24,71	0,50	-24,21	1,71	2,21	0,00	-22,50	
1049	S+0_c	1	SI Ø610/850	25,04	0,50	-24,54	2,04	2,54	0,00	-22,50	
1050	S+0_c	1	SI Ø610/850	24,72	0,50	-24,22	1,72	2,22	0,00	-22,50	
1054	S+6_s	1	SI Ø762/950	24,25	0,50	-23,75	4,75	5,25	0,00	-19,00	
1056	S+6_s	1	SI Ø610/850	22,59	0,50	-22,09	1,59	2,09	0,00	-20,50	
1057	S+9_s	1	SI Ø610/850	22,11	0,50	-21,61	0,61	1,11	0,00	-21,00	
1059	S+6_s	1	SI Ø610/850	22,81	0,50	-22,31	1,81	2,31	0,00	-20,50	
1061	S+0_s	1	SI Ø610/850	24,39	0,50	-23,89	1,89	2,39	0,00	-22,00	
1064	S+0_s	1	SI Ø610/850	20,09	0,50	-19,59	2,59	3,09	0,00	-17,00	
1065	S+0_s	1	SI Ø610/850	21,21	0,50	-20,71	3,71	4,21	0,00	-17,00	
1070	S+3_c	1	SI Ø610/850	23,93	0,50	-23,43	2,93	3,43	0,00	-20,50	
1071	S+3_c	1	SI Ø610/850	22,26	0,50	-21,76	1,26	1,76	0,00	-20,50	
1072	S+9_c	1	SI Ø610/850	21,21	0,50	-20,71	0,21	0,71	0,00	-20,50	
1073	S+9_c	1	SI Ø610/850	21,60	0,50	-21,10	0,60	1,10	0,00	-20,50	
1074	S+6_c	1	SI Ø610/850	21,36	0,50	-20,86	0,36	0,86	0,00	-20,50	
1075	S+3_c	1	SI Ø762/950	22,84	0,50	-22,34	5,84	6,34	0,00	-16,50	
1076	S+12_c	2	SI Ø508/670	12,08	0,00	-12,08	2,08	2,58	0,50	-10,00	
1077	S+12_c	2	SI Ø508/670	18,48	0,00	-18,48	0,48	0,98	0,50	-18,00	
1080	S+6_c	1	SI Ø610/850	24,18	0,50	-23,68	0,18	0,68	0,00	-23,50	
1081	S+0_c	2	SI Ø508/670	23,66	0,00	-23,66	7,16	7,66	0,50	-16,50	
1082	S+6_c	1	SI Ø610/850	24,20	0,50	-23,70	0,20	0,70	0,00	-23,50	
1083	S+3_c	1	SI Ø610/850	24,81	0,50	-24,31	0,81	1,31	0,00	-23,50	
1084	S+0_c	1	SI Ø610/850	22,56	0,50	-22,06	0,06	0,56	0,00	-22,00	
1085	S+0_c	1	SI Ø610/850	22,40	0,50	-21,90	-0,10	0,40	0,00	-22,00	
1087	S+6_c	1	SI Ø610/850	23,91	0,50	-23,41	-0,09	0,41	0,00	-23,50	
1088	S+9_c	1	SI Ø610/850	23,78	0,50	-23,28	-0,22	0,28	0,00	-23,50	
1090	S+0_c	1	SI Ø610/850	22,57	0,50	-22,07	0,07	0,57	0,00	-22,00	

1091	S+0_c	2	SI Ø508/670	20,85	0,00	-20,85	-0,15	0,35	0,50	-21,00
1092	S+0_c	2	SI Ø508/670	20,88	0,00	-20,88	-0,12	0,38	0,50	-21,00
1093	S+3_c	2	SI Ø508/670	22,20	0,00	-22,20	-0,30	0,20	0,50	-22,50
1096	S+0_c	2	SI Ø508/670	21,01	0,00	-21,01	0,01	0,51	0,50	-21,00
1097	S+0_c	2	SI Ø508/670	21,25	0,00	-21,25	0,25	0,75	0,50	-21,00
1100	S+6_c	2	SI Ø508/670	21,79	0,00	-21,79	-0,71	-0,21	0,50	-22,50
1101	S+6_c	2	SI Ø508/670	22,12	0,00	-22,12	-0,38	0,12	0,50	-22,50
1102	S+9_c	2	SI Ø508/670	22,18	0,00	-22,18	-0,82	-0,32	0,50	-23,00
1103	S+9_c	2	SI Ø508/670	18,96	0,50	-18,46	0,46	0,96	0,00	-18,00
1104	S+3_c	2	SI Ø508/670	16,64	0,00	-16,64	-0,36	0,14	0,50	-17,00
1106	S+0_c	1	SI Ø762/950	23,40	0,50	-22,90	-0,10	0,40	0,00	-23,00
1107	S+0_c	1	SI Ø762/950	23,29	0,50	-22,79	-0,21	0,29	0,00	-23,00
1108	S+0_c	1	SI Ø762/950	23,53	0,50	-23,03	0,03	0,53	0,00	-23,00
1109	S+0_c	1	SI Ø762/950	23,58	0,50	-23,08	0,08	0,58	0,00	-23,00
1110	S+3_c	2	SI Ø508/670	17,36	0,00	-17,36	0,36	0,86	0,50	-17,00
1112	S+0_c	1	SI Ø762/950	23,45	0,50	-22,95	-0,05	0,45	0,00	-23,00
1113	S+0_c	1	SI Ø762/950	23,24	0,50	-22,74	-0,26	0,24	0,00	-23,00
1115	S+12_c	2	SI Ø508/670	18,91	0,00	-18,91	0,41	0,91	0,50	-18,50
1116	S+12_c	2	SI Ø508/670	18,34	0,00	-18,34	-0,16	0,34	0,50	-18,50
1117	S+12_c	2	SI Ø508/670	16,60	0,00	-16,60	-0,40	0,10	0,50	-17,00
1119	S-3_c	1	SI Ø610/850	20,15	0,50	-19,65	-0,35	0,15	0,00	-20,00
1120	S-3_c	1	SI Ø610/850	20,21	0,50	-19,71	-0,29	0,21	0,00	-20,00
1121	S-3_c	1	SI Ø610/850	20,62	0,50	-20,12	0,12	0,62	0,00	-20,00
1122	S+0_c	1	SI Ø610/850	21,53	0,50	-21,03	0,03	0,53	0,00	-21,00
1124	S+0_c	1	SI Ø610/850	20,70	0,50	-20,20	-0,80	-0,30	0,00	-21,00
1125	S+0_c	1	SI Ø610/850	20,56	0,50	-20,06	-0,95	-0,45	0,00	-21,00
1126	S+0_c	1	SI Ø610/850	20,59	0,50	-20,09	-0,92	-0,42	0,00	-21,00
1127	S+0_c	1	SI Ø610/850	20,21	0,50	-19,71	-1,29	-0,79	0,00	-21,00
1129	S+0_c	1	SI Ø610/850	20,78	0,50	-20,28	-0,72	-0,22	0,00	-21,00
1132	S+0_c	1	SI Ø610/850	20,25	0,50	-19,75	-1,25	-0,75	0,00	-21,00
1134	S+0_c	1	SI Ø610/850	19,86	0,50	-19,36	-1,15	-0,65	0,00	-20,50
1135	S+0_c	1	SI Ø610/850	20,13	0,50	-19,63	-0,87	-0,37	0,00	-20,50
1136	S+0_c	1	SI Ø610/850	20,39	0,50	-19,89	-0,61	-0,11	0,00	-20,50
1138	S+3_c	1	SI Ø610/850	22,40	0,50	-21,90	-0,10	0,40	0,00	-22,00
1139	S+3_c	1	SI Ø610/850	22,41	0,50	-21,91	-0,09	0,41	0,00	-22,00
1140	S+0_c	1	SI Ø610/850	20,90	0,50	-20,40	-0,10	0,40	0,00	-20,50
1141	S+0_c	1	SI Ø610/850	21,10	0,50	-20,60	0,10	0,60	0,00	-20,50
1142	S+0_c	1	SI Ø610/850	21,03	0,50	-20,53	0,03	0,53	0,00	-20,50
1143	S+0_c	1	SI Ø610/850	21,06	0,50	-20,56	0,06	0,56	0,00	-20,50
1144	S+0_c	1	SI Ø610/850	21,04	0,50	-20,54	0,04	0,54	0,00	-20,50
1145	S+0_c	1	SI Ø610/850	20,87	0,50	-20,37	-0,13	0,37	0,00	-20,50
1146	S+0_c	1	SI Ø610/850	20,79	0,50	-20,29	-0,21	0,29	0,00	-20,50
1149	S+24_s	2	SI Ø508/670	15,94	0,00	-15,94	0,44	0,94	0,50	-15,50
1155	S+3_c	1	SI Ø610/850	20,83	0,50	-20,33	0,33	0,83	0,00	-20,00
1156	S+6_c	1	SI Ø610/850	22,24	0,50	-21,74	0,24	0,74	0,00	-21,50
1157	S+6_c	1	SI Ø610/850	23,44	0,50	-22,94	1,44	1,94	0,00	-21,50
1160	S+3_c	1	SI Ø610/850	22,63	0,50	-22,13	0,63	1,13	0,00	-21,50
1161	S+0_c	1	SI Ø610/850	20,68	0,50	-20,18	0,18	0,68	0,00	-20,00
1162	S+0_c	1	SI Ø610/850	20,84	0,50	-20,34	0,34	0,84	0,00	-20,00
1164	S+0_c	1	SI Ø610/850	21,96	0,50	-21,46	-0,04	0,46	0,00	-21,50
1165	S+6_c	1	SI Ø610/850	23,31	0,50	-22,81	-0,19	0,31	0,00	-23,00
1166	S+6_c	1	SI Ø610/850	23,03	0,50	-22,53	-0,47	0,03	0,00	-23,00
1169	S+3_c	1	SI Ø610/850	23,15	0,50	-22,65	-0,35	0,15	0,00	-23,00
1170	S+0_c	1	SI Ø610/850	21,63	0,50	-21,13	-0,38	0,13	0,00	-21,50
1171	S+0_c	1	SI Ø610/850	21,97	0,50	-21,47	-0,03	0,47	0,00	-21,50
1172	S+3_c	1	SI Ø610/850	22,13	0,50	-21,63	0,13	0,63	0,00	-21,50
1173	S+0_c	1	SI Ø610/850	22,06	0,50	-21,56	0,06	0,56	0,00	-21,50
1174	S+0_c	1	SI Ø610/850	22,18	0,50	-21,68	0,18	0,68	0,00	-21,50
1175	S+0_c	1	SI Ø610/850	22,25	0,50	-21,75	0,25	0,75	0,00	-21,50
1176	S+0_c	1	SI Ø610/850	22,46	0,50	-21,96	0,46	0,96	0,00	-21,50
1178	S+3_c	1	SI Ø610/850	18,36	0,50	-17,86	0,36	0,86	0,00	-17,50
1179	S+3_c	1	SI Ø610/850	18,61	0,50	-18,11	0,61	1,11	0,00	-17,50
1180	S+3_c	1	SI Ø610/850	18,99	0,50	-18,49	0,99	1,49	0,00	-17,50

1181	S+3_c	1	SI Ø610/850	19,36	0,50	-18,86	1,36	1,86	0,00	-17,50
1182	S+0_c	1	SI Ø610/850	17,24	0,50	-16,74	1,24	1,74	0,00	-15,50
1183	S+0_c	1	SI Ø610/850	17,52	0,50	-17,02	1,52	2,02	0,00	-15,50
1185	S+3_c	1	SI Ø610/850	20,74	0,50	-20,24	2,74	3,24	0,00	-17,50
1186	S+0_c	1	SI Ø610/850	20,47	0,50	-19,97	2,47	2,97	0,00	-17,50
1189	S+0_c	1	SI Ø610/850	20,03	0,50	-19,53	4,03	4,53	0,00	-15,50
1190	S+0_c	1	SI Ø610/850	20,49	0,50	-19,99	4,49	4,99	0,00	-15,50
1191	S-3_c	1	SI Ø610/850	16,00	0,50	-15,50	5,00	5,50	0,00	-10,50
1193	S+9_c	1	SI Ø610/850	18,72	0,50	-18,22	5,72	6,22	0,00	-12,50
1195	S+0_c	1	SI Ø610/850	17,87	0,50	-17,37	6,87	7,37	0,00	-10,50
1197	S+9_c	1	SI Ø610/850	21,10	0,50	-20,60	8,10	8,60	0,00	-12,50
1197A	S+9_c	1	SI Ø610/850	21,50	0,50	-21,00	8,50	9,00	0,00	-12,50
1198	S+6_c	1	SI Ø610/850	20,96	0,50	-20,46	8,46	8,96	0,00	-12,00
1200	S+3_c	1	SI Ø610/850	21,83	0,50	-21,33	9,33	9,83	0,00	-12,00
1201	S+0_c	1	SI Ø610/850	20,31	0,50	-19,81	9,31	9,81	0,00	-10,50
1202	S+0_c	1	SI Ø610/850	20,25	0,50	-19,75	9,25	9,75	0,00	-10,50
1203	S+3_c	1	SI Ø610/850	22,29	0,50	-21,79	9,79	10,29	0,00	-12,00

Poergegevens

Mastnr.	Masttype	Poertype	L [m]	b [m]2	h [m]	Bovenkant poer tov. NAP [m]	Bovenkant poer tov MV [m] (1)	Onderkant poer tov. MV [m]	Volume onder GWS [m]	Volume poer [m3]	EGpoer [kN]
1003	S+18_s	2-paalspoer	3,00	1,50	2,00	1,85	0,50	-1,50	6,75	9,00	225
1004	S+18_s	2-paalspoer	3,00	1,50	2,00	2,01	0,50	-1,50	6,75	9,00	225
1076	S+12_c	2-paalspoer	3,00	1,50	2,00	2,58	0,50	-1,50	6,75	9,00	225
1077	S+12_c	2-paalspoer	3,00	1,50	2,00	0,98	0,50	-1,50	6,75	9,00	225
1081	S+0_c	2-paalspoer	3,00	1,50	2,00	7,66	0,50	-1,50	6,75	9,00	225
1091	S+0_c	2-paalspoer	3,00	1,50	2,00	0,35	0,50	-1,50	6,75	9,00	225
1092	S+0_c	2-paalspoer	3,00	1,50	2,00	0,38	0,50	-1,50	6,75	9,00	225
1093	S+3_c	2-paalspoer	3,00	1,50	2,00	0,20	0,50	-1,50	6,75	9,00	225
1096	S+0_c	2-paalspoer	3,00	1,50	2,00	0,51	0,50	-1,50	6,75	9,00	225
1097	S+0_c	2-paalspoer	3,00	1,50	2,00	0,75	0,50	-1,50	6,75	9,00	225
1100	S+6_c	2-paalspoer	3,00	1,50	2,00	-0,21	0,50	-1,50	6,75	9,00	225
1101	S+6_c	2-paalspoer	3,00	1,50	2,00	0,12	0,50	-1,50	6,75	9,00	225
1102	S+9_c	2-paalspoer	3,00	1,50	2,00	-0,32	0,50	-1,50	6,75	9,00	225
1103	S+9_c	2-paalspoer HW	3,00	1,80	2,50	0,96	1,00	-1,50	8,10	13,50	338
1104	S+3_c	2-paalspoer	3,00	1,50	2,00	0,14	0,50	-1,50	6,75	9,00	225
1110	S+3_c	2-paalspoer	3,00	1,50	2,00	0,86	0,50	-1,50	6,75	9,00	225
1115	S+12_c	2-paalspoer	3,00	1,50	2,00	0,91	0,50	-1,50	6,75	9,00	225
1116	S+12_c	2-paalspoer	3,00	1,50	2,00	0,34	0,50	-1,50	6,75	9,00	225
1117	S+12_c	2-paalspoer	3,00	1,50	2,00	0,10	0,50	-1,50	6,75	9,00	225
1149	S+24_s	2-paalspoer	3,00	1,50	2,00	0,94	0,50	-1,50	6,75	9,00	225

APPENDIX C

Resultaten

Controle op trek en drukbelasting

Toetsing funderingen op trekbelasting												
Mast	Masttype	Sondering	Poertype	Paaltype	PP niveau [m- NAP]	F _{Ed,mast} [kN]	Aantal palen per randstijl	Effectiviteit palen	F _{poer,d} [kN]	F _{Ed,paal} [kN]	F _{R,d,trek} [kN]	U.C.
1003	S+18_s	2019-1008_1.GEF	2-paalspoer	SI Ø508/670	-21,5	-1750	2	95%	135	850	985	0,86
1004	S+18_s	2019-1008_1.GEF	2-paalspoer	SI Ø508/670	-21,5	-1750	2	95%	135	850	985	0,86
1006	S+0_s	2019-1008_1.GEF	1-paals	SI Ø610/850	-23,0	-1240	1	100%	0	1240	1412	0,88
1008	S+0_s	2019-1008_1.GEF	1-paals	SI Ø610/850	-23,0	-1240	1	100%	0	1240	1412	0,88
1009	S+0_s	2019-1008_1.GEF	1-paals	SI Ø610/850	-23,0	-1240	1	100%	0	1240	1412	0,88
1010	S+0_s	2019-1008_1.GEF	1-paals	SI Ø610/850	-23,0	-1240	1	100%	0	1240	1412	0,88
1011	S-3_s	2019-1008_1.GEF	1-paals	SI Ø610/850	-22,0	-1132	1	100%	0	1132	1297	0,87
1012	S-3_s	2019-1008_1.GEF	1-paals hoog	SI Ø610/850	-22,0	-1132	1	100%	0	1132	1297	0,87
1013	S-3_s	2019-1008_1.GEF	1-paals hoog	SI Ø610/850	-22,0	-1132	1	100%	0	1132	1297	0,87
1026	S-3_c	2019-1008_6.GEF	1-paals	SI Ø610/850	-8,5	-1239	1	100%	0	1239	1408	0,88
1028	S+0_c	2019-1008_6.GEF	1-paals	SI Ø610/850	-9,5	-1333	1	100%	0	1333	1523	0,88
1029	S+6_c	2019-1008_6.GEF	1-paals	SI Ø610/850	-9,5	-1481	1	100%	0	1481	1523	0,97
1030	S+3_c	2019-1008_6.GEF	1-paals	SI Ø610/850	-10,5	-1461	1	100%	0	1461	1638	0,89
1031	S+0_c	2019-1008_6.GEF	1-paals	SI Ø610/850	-9,5	-1333	1	100%	0	1333	1523	0,88
1032	S+3_c	02P001595_166.S01.GEF	1-paals	SI Ø610/850	-16,5	-1461	1	100%	0	1461	1646	0,89
1034	S+0_c	02P001595_166.S01.GEF	1-paals	SI Ø610/850	-15,0	-1333	1	100%	0	1333	1473	0,90
1035	S+0_c	02P001595_166.S01.GEF	1-paals	SI Ø610/850	-15,0	-1333	1	100%	0	1333	1473	0,90
1036	S+3_c	02P001595_166.S01.GEF	1-paals	SI Ø762/950	-14,0	-1461	1	100%	0	1461	1620	0,90
1038	S+0_c	02P001595_166.S01.GEF	1-paals	SI Ø610/850	-15,0	-1333	1	100%	0	1333	1473	0,90
1039	S+3_c	02P001595_166.S01.GEF	1-paals	SI Ø610/850	-16,5	-1461	1	100%	0	1461	1646	0,89
1040	S+3_c	02P001595_166.S01.GEF	1-paals	SI Ø610/850	-16,5	-1461	1	100%	0	1461	1646	0,89
1041	S+0_c	02P001595_166.S01.GEF	1-paals	SI Ø610/850	-15,0	-1333	1	100%	0	1333	1473	0,90
1042	S+0_c	02P001595_166.S01.GEF	1-paals	SI Ø610/850	-15,0	-1333	1	100%	0	1333	1473	0,90
1043	S+3_c	02P001595_166.S01.GEF	1-paals	SI Ø610/850	-16,5	-1461	1	100%	0	1461	1646	0,89
1045	S+0_c	02P001595_166.S01.GEF	1-paals	SI Ø610/850	-15,0	-1333	1	100%	0	1333	1473	0,90
1046	S+0_c	02P001595_166.S01.GEF	1-paals	SI Ø610/850	-15,0	-1333	1	100%	0	1333	1473	0,90
1047	S+0_c	2019-1008_11.GEF	1-paals	SI Ø762/950	-20,5	-1333	1	100%	0	1333	1497	0,89
1048	S+0_c	2019-1008_11.GEF	1-paals	SI Ø610/850	-22,5	-1333	1	100%	0	1333	1479	0,90
1049	S+0_c	2019-1008_11.GEF	1-paals	SI Ø610/850	-22,5	-1333	1	100%	0	1333	1479	0,90
1050	S+0_c	2019-1008_11.GEF	1-paals	SI Ø610/850	-22,5	-1333	1	100%	0	1333	1479	0,90
1054	S+6_s	2019-1008_11.GEF	1-paals	SI Ø762/950	-19,0	-1128	1	100%	0	1128	1292	0,87
1056	S+6_s	2019-1008_11.GEF	1-paals	SI Ø610/850	-20,5	-1128	1	100%	0	1128	1252	0,90
1057	S+9_s	2019-1008_11.GEF	1-paals	SI Ø610/850	-21,0	-1151	1	100%	0	1151	1309	0,88
1059	S+6_s	2019-1008_11.GEF	1-paals	SI Ø610/850	-20,5	-1128	1	100%	0	1128	1252	0,90
1061	S+0_s	2019-1008_11.GEF	1-paals	SI Ø610/850	-22,0	-1240	1	100%	0	1240	1421	0,87
1064	S+0_s	2019-1008_12.GEF	1-paals	SI Ø610/850	-17,0	-1240	1	100%	0	1240	1378	0,90
1065	S+0_s	2019-1008_12.GEF	1-paals	SI Ø610/850	-17,0	-1240	1	100%	0	1240	1378	0,90
1070	S+3_c	2019-1008_12.GEF	1-paals	SI Ø610/850	-20,5	-1461	1	100%	0	1461	1681	0,87
1071	S+3_c	2019-1008_12.GEF	1-paals	SI Ø610/850	-20,5	-1461	1	100%	0	1461	1681	0,87
1072	S+9_c	2019-1008_12.GEF	1-paals	SI Ø610/850	-20,5	-1495	1	100%	0	1495	1681	0,89
1073	S+9_c	2019-1008_12.GEF	1-paals	SI Ø610/850	-20,5	-1495	1	100%	0	1495	1681	0,89
1074	S+6_c	2019-1008_12.GEF	1-paals	SI Ø610/850	-20,5	-1481	1	100%	0	1481	1681	0,88
1075	S+3_c	2019-1008_12.GEF	1-paals	SI Ø762/950	-16,5	-1461	1	100%	0	1461	1618	0,90
1076	S+12_c	2019-1008_12.GEF	2-paalspoer	SI Ø508/670	-10,0	-1582	2	95%	135	761	910	0,84
1077	S+12_c	2019-1008_17.GEF	2-paalspoer	SI Ø508/670	-18,0	-1582	2	95%	135	761	874	0,87
1080	S+6_c	2019-1008_17.GEF	1-paals	SI Ø610/850	-23,5	-1481	1	100%	0	1481	1661	0,89
1081	S+0_c	2019-1008_17.GEF	2-paalspoer	SI Ø508/670	-16,5	-1333	2	95%	135	630	727	0,87
1082	S+6_c	2019-1008_17.GEF	1-paals	SI Ø610/850	-23,5	-1481	1	100%	0	1481	1661	0,89
1083	S+3_c	2019-1008_17.GEF	1-paals	SI Ø610/850	-23,5	-1461	1	100%	0	1461	1661	0,88
1084	S+0_c	2019-1008_17.GEF	1-paals	SI Ø610/850	-22,0	-1333	1	100%	0	1333	1488	0,90
1085	S+0_c	2019-1008_17.GEF	1-paals	SI Ø610/850	-22,0	-1333	1	100%	0	1333	1488	0,90
1087	S+6_c	2019-1008_17.GEF	1-paals	SI Ø610/850	-23,5	-1481	1	100%	0	1481	1661	0,89
1088	S+9_c	2019-1008_17.GEF	1-paals	SI Ø610/850	-23,5	-1495	1	100%	0	1495	1661	0,90
1090	S+0_c	2019-1008_17.GEF	1-paals	SI Ø610/850	-22,0	-1333	1	100%	0	1333	1488	0,90
1091	S+0_c	2019-1008_20.GEF	2-paalspoer	SI Ø508/670	-21,0	-1333	2	95%	135	630	745	0,85
1092	S+0_c	2019-1008_20.GEF	2-paalspoer	SI Ø508/670	-21,0	-1333	2	95%	135	630	745	0,85
1093	S+3_c	2019-1008_20.GEF	2-paalspoer	SI Ø508/670	-22,5	-1461	2	95%	135	698	799	0,87
1096	S+0_c	2019-1008_20.GEF	2-paalspoer	SI Ø508/670	-21,0	-1333	2	95%	135	630	745	0,85
1097	S+0_c	2019-1008_20.GEF	2-paalspoer	SI Ø508/670	-21,0	-1333	2	95%	135	630	745	0,85
1100	S+6_c	2019-1008_20.GEF	2-paalspoer	SI Ø508/670	-22,5	-1481	2	95%	135	708	799	0,89



1197	S+9_c	2019-1008_43.GEF	1-paals	SI Ø610/850	-12,5	-1495	1	100%	0	1495	1709	0,87
1197A	S+9_c	2019-1008_43.GEF	1-paals	SI Ø610/850	-12,5	-1495	1	100%	0	1495	1709	0,87
1198	S+6_c	2019-1008_43.GEF	1-paals	SI Ø610/850	-12,0	-1481	1	100%	0	1481	1652	0,90
1200	S+3_c	2019-1008_43.GEF	1-paals	SI Ø610/850	-12,0	-1461	1	100%	0	1461	1652	0,88
1201	S+0_c	2019-1008_43.GEF	1-paals	SI Ø610/850	-10,5	-1333	1	100%	0	1333	1479	0,90
1202	S+0_c	2019-1008_43.GEF	1-paals	SI Ø610/850	-10,5	-1333	1	100%	0	1333	1479	0,90
1203	S+3_c	2019-1008_43.GEF	1-paals	SI Ø610/850	-12,0	-1461	1	100%	0	1461	1652	0,88

Toetsing funderingen op drukbelasting

Mast	Masttype	Sondering	Poorttype	Paalttype	PP niveau [m- NAP]	F _{Ed,mast} [kN]	Aantal palen per randstijl	Effectiviteit palen	F _{poer,d} [kN]	F _{Ed,paal} [kN]	F _{R,d,druk} [kN]	U.C.
1003	S+18_s	2019-1008_1.GEF	2-paalspoer	SI Ø508/670	-21,5	2170	2	95%	270	1284	3011	0,43
1004	S+18_s	2019-1008_1.GEF	2-paalspoer	SI Ø508/670	-21,5	2170	2	95%	270	1284	3011	0,43
1006	S+0_s	2019-1008_1.GEF	1-paals	SI Ø610/850	-23,0	1532	1	100%	0	1532	5740	0,27
1008	S+0_s	2019-1008_1.GEF	1-paals	SI Ø610/850	-23,0	1532	1	100%	0	1532	5740	0,27
1009	S+0_s	2019-1008_1.GEF	1-paals	SI Ø610/850	-23,0	1532	1	100%	0	1532	5740	0,27
1010	S+0_s	2019-1008_1.GEF	1-paals	SI Ø610/850	-23,0	1532	1	100%	0	1532	5740	0,27
1011	S-3_s	2019-1008_1.GEF	1-paals	SI Ø610/850	-22,0	1414	1	100%	0	1414	5554	0,25
1012	S-3_s	2019-1008_1.GEF	1-paals hoog	SI Ø610/850	-22,0	1414	1	100%	0	1414	5554	0,25
1013	S-3_s	2019-1008_1.GEF	1-paals hoog	SI Ø610/850	-22,0	1414	1	100%	0	1414	5554	0,25
1026	S-3_c	2019-1008_6.GEF	1-paals	SI Ø610/850	-8,5	1628	1	100%	0	1628	4805	0,34
1028	S+0_c	2019-1008_6.GEF	1-paals	SI Ø610/850	-9,5	1743	1	100%	0	1743	5053	0,34
1029	S+6_c	2019-1008_6.GEF	1-paals	SI Ø610/850	-9,5	1910	1	100%	0	1910	5053	0,38
1030	S+3_c	2019-1008_6.GEF	1-paals	SI Ø610/850	-10,5	1878	1	100%	0	1878	5850	0,32
1031	S+0_c	2019-1008_6.GEF	1-paals	SI Ø610/850	-9,5	1743	1	100%	0	1743	5053	0,34
1032	S+3_c	02P001595_166.S01.GEF	1-paals	SI Ø610/850	-16,5	1878	1	100%	0	1878	4639	0,40
1034	S+0_c	02P001595_166.S01.GEF	1-paals	SI Ø610/850	-15,0	1743	1	100%	0	1743	3983	0,44
1035	S+0_c	02P001595_166.S01.GEF	1-paals	SI Ø610/850	-15,0	1743	1	100%	0	1743	3983	0,44
1036	S+3_c	02P001595_166.S01.GEF	1-paals	SI Ø762/950	-14,0	1878	1	100%	0	1878	4767	0,39
1038	S+0_c	02P001595_166.S01.GEF	1-paals	SI Ø610/850	-15,0	1743	1	100%	0	1743	3983	0,44
1039	S+3_c	02P001595_166.S01.GEF	1-paals	SI Ø610/850	-16,5	1878	1	100%	0	1878	4639	0,40
1040	S+3_c	02P001595_166.S01.GEF	1-paals	SI Ø610/850	-16,5	1878	1	100%	0	1878	4639	0,40
1041	S+0_c	02P001595_166.S01.GEF	1-paals	SI Ø610/850	-15,0	1743	1	100%	0	1743	3983	0,44
1042	S+0_c	02P001595_166.S01.GEF	1-paals	SI Ø610/850	-15,0	1743	1	100%	0	1743	3983	0,44
1043	S+3_c	02P001595_166.S01.GEF	1-paals	SI Ø610/850	-16,5	1878	1	100%	0	1878	4639	0,40
1045	S+0_c	02P001595_166.S01.GEF	1-paals	SI Ø610/850	-15,0	1743	1	100%	0	1743	3983	0,44
1046	S+0_c	02P001595_166.S01.GEF	1-paals	SI Ø610/850	-15,0	1743	1	100%	0	1743	3983	0,44
1047	S+0_c	2019-1008_11.GEF	1-paals	SI Ø762/950	-20,5	1743	1	100%	0	1743	4178	0,42
1048	S+0_c	2019-1008_11.GEF	1-paals	SI Ø610/850	-22,5	1743	1	100%	0	1743	3239	0,54
1049	S+0_c	2019-1008_11.GEF	1-paals	SI Ø610/850	-22,5	1743	1	100%	0	1743	3239	0,54
1050	S+0_c	2019-1008_11.GEF	1-paals	SI Ø610/850	-22,5	1743	1	100%	0	1743	3239	0,54
1054	S+6_s	2019-1008_11.GEF	1-paals	SI Ø762/950	-19,0	1445	1	100%	0	1445	4595	0,31
1056	S+6_s	2019-1008_11.GEF	1-paals	SI Ø610/850	-20,5	1445	1	100%	0	1445	3283	0,44
1057	S+9_s	2019-1008_11.GEF	1-paals	SI Ø610/850	-21,0	1495	1	100%	0	1495	3352	0,45
1059	S+6_s	2019-1008_11.GEF	1-paals	SI Ø610/850	-20,5	1445	1	100%	0	1445	3283	0,44
1061	S+0_s	2019-1008_11.GEF	1-paals	SI Ø610/850	-22,0	1532	1	100%	0	1532	3242	0,47
1064	S+0_s	2019-1008_12.GEF	1-paals	SI Ø610/850	-17,0	1532	1	100%	0	1532	2556	0,60
1065	S+0_s	2019-1008_12.GEF	1-paals	SI Ø610/850	-17,0	1532	1	100%	0	1532	2556	0,60
1070	S+3_c	2019-1008_12.GEF	1-paals	SI Ø610/850	-20,5	1878	1	100%	0	1878	3851	0,49
1071	S+3_c	2019-1008_12.GEF	1-paals	SI Ø610/850	-20,5	1878	1	100%	0	1878	3851	0,49
1072	S+9_c	2019-1008_12.GEF	1-paals	SI Ø610/850	-20,5	1955	1	100%	0	1955	3851	0,51
1073	S+9_c	2019-1008_12.GEF	1-paals	SI Ø610/850	-20,5	1955	1	100%	0	1955	3851	0,51
1074	S+6_c	2019-1008_12.GEF	1-paals	SI Ø610/850	-20,5	1910	1	100%	0	1910	3851	0,50
1075	S+3_c	2019-1008_12.GEF	1-paals	SI Ø762/950	-16,5	1878	1	100%	0	1878	3002	0,63
1076	S+12_c	2019-1008_12.GEF	2-paalspoer	SI Ø508/670	-10,0	2093	2	95%	270	1244	1596	0,78
1077	S+12_c	2019-1008_17.GEF	2-paalspoer	SI Ø508/670	-18,0	2093	2	95%	270	1244	1465	0,85
1080	S+6_c	2019-1008_17.GEF	1-paals	SI Ø610/850	-23,5	1910	1	100%	0	1910	3274	0,58
1081	S+0_c	2019-1008_17.GEF	2-paalspoer	SI Ø508/670	-16,5	1743	2	95%	270	1059	1406	0,75
1082	S+6_c	2019-1008_17.GEF	1-paals	SI Ø610/850	-23,5	1910	1	100%	0	1910	3274	0,58
1083	S+3_c	2019-1008_17.GEF	1-paals	SI Ø610/850	-23,5	1878	1	100%	0	1878	3274	0,57
1084	S+0_c	2019-1008_17.GEF	1-paals	SI Ø610/850	-22,0	1743	1	100%	0	1743	3186	0,55
1085	S+0_c	2019-1008_17.GEF	1-paals	SI Ø610/850	-22,0	1743	1	100%	0	1743	3186	0,55
1087	S+6_c	2019-1008_17.GEF	1-paals	SI Ø610/850	-23,5	1910	1	100%	0	1910	3274	0,58
1088	S+9_c	2019-1008_17.GEF	1-paals	SI Ø610/850	-23,5	1955	1	100%	0	1955	3274	0,60
1090	S+0_c	2019-1008_17.GEF	1-paals	SI Ø610/850	-22,0	1743	1	100%	0	1743	3186	0,55
1091	S+0_c	2019-1008_20.GEF	2-paalspoer	SI Ø508/670	-21,0	1743	2	95%	270	1059	1297	0,82
1092	S+0_c	2019-1008_20.GEF	2-paalspoer	SI Ø508/670	-21,0	1743	2	95%	270	1059	1297	0,82
1093	S+3_c	2019-1008_20.GEF	2-paalspoer	SI Ø508/670	-22,5	1878	2	95%	270	1130	1367	0,83
1096	S+0_c	2019-1008_20.GEF	2-paalspoer	SI Ø508/670	-21,0	1743	2	95%	270	1059	1297	0,82
1097	S+0_c	2019-1008_20.GEF	2-paalspoer	SI Ø508/670	-21,0	1743	2	95%	270	1059	1297	0,82
1100	S+6_c	2019-1008_20.GEF	2-paalspoer	SI Ø508/670	-22,5	1910	2	95%	270	1147	1367	0,84
1101	S+6_c	2019-1008_20.GEF	2-paalspoer	SI Ø508/670	-22,5	1910	2	95%	270	1147	1367	0,84
1102	S+9_c	2019-1008_20.GEF	2-paalspoer	SI Ø508/670	-23,0	1955	2	95%	270	1171	1627	0,72
1103	S+9_c	2019-1008_21.GEF	2-paalspoer HW	SI Ø508/670	-18,0	1955	2	95%	405	1242	1357	0,92



1200	S+3_c	2019-1008_43.GEF	1-paals	SI Ø610/850	-12,0	1878	1	100%	0	1878	4198	0,45
1201	S+0_c	2019-1008_43.GEF	1-paals	SI Ø610/850	-10,5	1743	1	100%	0	1743	3923	0,44
1202	S+0_c	2019-1008_43.GEF	1-paals	SI Ø610/850	-10,5	1743	1	100%	0	1743	3923	0,44
1203	S+3_c	2019-1008_43.GEF	1-paals	SI Ø610/850	-12,0	1878	1	100%	0	1878	4198	0,45

Controle kluitgewicht

De minimaal benodigde lengte van de paal op basis van het kluitgewicht is onderzocht. Het kluitgewicht is het gewicht van de kluit grond die zich door wrijving verzet tegen het uittrekken van de paal met die kluit uit de grond. Zolang dit gewicht groter is dan de trekkracht zal de paal met de kluit grond niet uit de grond getrokken worden.

Kluitgewicht kan een issue zijn voor korte palen die op trek worden belast, waarvan de kleef de trekkracht wel kan weerstaan. Als voorbeeld betreft het zandgronden zonder veel slappe lagen.

De minimale paallengtes op basis van de sonderingen zijn 16 m respectievelijk 12,1 m voor de enkelpaalsfundering en de tweepaalsfundering. De bijbehorende belastingen zijn 1333 kN voor de enkelpaalsfundering en 1540 kN voor de tweepaalsfundering. Voor de tweepaalsfundering is de bijbehorende belasting $2 \times 770 = 1540$ kN.

In deze berekening wordt bepaald wat de minimaal benodigde paallengte is voor voldoende kluitgewicht voor de enkelpaalsfundering belast door 1333 kN en de tweepaalsfundering belast door 1540 kN. Indien de lengte onvoldoende is, dan zal de paal met kluit uit de grond getrokken worden. Zie hieronder.

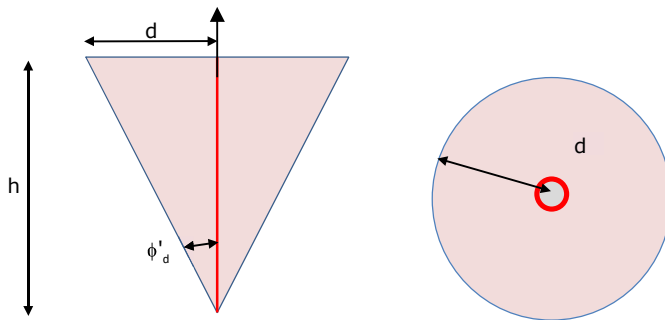

Figuur. Zijaanzicht (links) en bovenaanzicht (rechts) van de kluit grond

Algemene gegevens

Volumiek gewicht grond		18	kN/m ³
Volumiek gewicht water		10	kN/m ³
Veiligheidsfactor	$\gamma_g =$	0,9	-
Hoek van inwendige wrijving	$\phi' =$	27,5	°
Veiligheidsfactor	$\gamma_\psi =$	1,25	-

Berekening kluitgewicht voor 1 paal

Diepte minimaal	$h =$	10,578	m
Radius kegel op mv.	$d = L \times (\tan \alpha / \gamma) =$	4,41	m
Grondoppervlak kegel	$A = \pi d^2 =$	61,0	m ²
Inhoud kegel	$I_{kluit} = 1/3Gh =$	215,0	m ³
Gewicht grond	$F_{gr} =$	3869	kN
Opwaartse kracht water	$F_w =$	2150	kN
Rekenwaarde	$F_{r,d} = 0,9F_{gr} - F_w =$	1333	kN

Uit de berekening van het kluitgewicht bij de enkelpaalsfundering blijkt dat de lengte van de paal niet onder de 10,6 m mag komen bij de belasting van 1333 kN.

Berekening kluitgewicht voor 2 palen

Diepte minimaal	$h =$	11,1	m
-----------------	-------	------	---

Radius kegel op mv.	$d = L \times (\tan \alpha / \gamma) =$	4,62 m
Grondoppervlak kegel	$A = \pi d^2 =$	67,1 m ²
Inhoud kegel	$I_{kluit} = 1/3Gh =$	248,4 m ³
Gewicht grond	$F_{gr} =$	4471 kN
Opwaartse kracht water	$F_w =$	2484 kN
Rekenwaarde	$F_{r,d} = 0,9F_{gr} - F_w =$	1540 kN

Uit de berekening van het kluitgewicht bij de tweepaalsfundering blijkt dat de lengte van de paal niet onder de 11,1 m mag komen bij de belasting van 1540 kN. Hier is conservatief de tweepaalspoer als een enkelpaalspoer beschouwd, het tussenoppervlak van de wig is verwaarloosd.

De minimale paallengtes op basis van de sonderingen zijn 16 m respectievelijk 12,1 m voor de enkelpaalsfundering en de tweepaalsfundering. Er is voldoende kluitgewicht. In het UO mag bij eventuele optimalisatie de lengte van de paal niet kleiner worden dan de hierboven berekende minimale paallengtes (10,6 en 11,1 m), tenzij de belasting kleiner is dan de aangehouden waarden van 1333 kN respectievelijk 1540 kN.

De maximale belasting voor de éénpaalsfundering is nooit groter dan 1495 kN (met paallengte 18,7 m op basis van sonderingen en een daarbij gemobiliseerd gewicht 7363 kN > 1495 kN). Deze lengte (bij die specifieke belasting) mag niet kleiner worden dan 11 m want dan wordt de trekbelasting 1495 kN meer dan het kluitgewicht.

De maximale belasting voor de tweepaalsfundering is nooit groter dan 2 palen x 859 = 1718 kN (met paallengte 22,8 m op basis van sondering en een daarbij gemobiliseerd gewicht 13346 kN > 1718). Deze lengte (bij die specifieke belasting) mag niet kleiner worden dan 11,5 m want dan wordt de trekbelasting 1718 kN meer dan het kluitgewicht.

Palen die een lage belasting hebben en dus een korte paaldiepte L1 hebben op basis van analyse sondering (en een nog lagere minimum paallengte L2 op basis van analyse kluitgewicht) hoeven we niet te verlengen tot minimale paaldiepte L4 (met L4 > L1) op basis van analyse kluitgewicht bij palen die een hoge belasting hebben (en een nog hogere paallengte L3 op basis van analyse sondering). In het uitvoeringsontwerp (UO) moet kluitgewicht worden gecontroleerd indien op basis van sonderingen wordt besloten de paallengte uit het definitief ontwerp (DO) te verlagen. Hierbij moet ook worden gelet op de minimale paallengte van 7 m of 13,5 m de middellijn volgens 7.6.3.3. van NEN-EN 1997-1.



APPENDIX D

Uitvoer TS paalfunderingen

ALGEMENE GEGEVENS

Project : ZWO380 Funderingen
 Onderdeel : RLL-TBG380
 Datum : 27-03-2021
 Bestand : P:\EANL_Projects\10124719 - TenneT Engineering
 ZW380 kV Oost\2 Content\007 DO
 vakwerkmaster\TS Paalfunderingen\ZWO380
 steunmast DO.pvw
 Berekeningstype : Verticaal belaste paal
 Alle niveaus/hoogtes/peilmaten zijn t.o.v.: N.A.P.

Toegepaste normen volgens Eurocode met Nederlandse NB

Geotechniek	EN 1997-1:2004	AC:2009	
	NEN-EN 1997-1:2005	C1+A1:2013	NB:2016
	NEN 9997-1:2016	C2:2017	

BODEMPROFIELGEGEVENS: 19-1008_1

Alle niveaus/hoogtes/peilmaten zijn t.o.v.: N.A.P.

d50-reductie is meegenomen overeenkomstig NEN-EN 9997 art. 7.6.2.3 (i)

Laag	Van [m]	Tot [m]	Omschrijving	OCR	Aandeel pos. kleef [%]	α_s	d_{50} [mm]
	Hoogte maaiveld [m] : 2.12		Grondwaterstand [m] : 1.12				
1	2.12	0.47	Zand - Schoon - Los	1.0	100.0		
2	0.47	-0.23	Klei - Zwak zandig - Matig	1.0	50.0		
3	-0.23	-1.33	Zand - Schoon - Los	1.0	100.0		
4	-1.33	-7.83	Klei - Organisch - Matig	1.0	50.0		
5	-7.83	-12.63	Klei - Zwak zandig - Matig	1.0	50.0		
6	-12.63	-17.12	Zand - Sterk siltig - Kleiig	1.0	100.0		
7	-17.12	-19.80	Zand - Zwak siltig - Kleiig	1.0	100.0		
8	-19.80	-21.20	Klei - Zwak zandig - Matig	1.0	50.0		
9	-21.20	-32.70	Zand - Schoon - Vast	1.0	100.0		

BODEMPROFIELGEGEVENS: 19-1008_6

Alle niveaus/hoogtes/peilmaten zijn t.o.v.: N.A.P.

d50-reductie is meegenomen overeenkomstig NEN-EN 9997 art. 7.6.2.3 (i)

Laag	Van [m]	Tot [m]	Omschrijving	OCR	Aandeel pos. kleef [%]	α_s	d_{50} [mm]
	Hoogte maaiveld [m] : 11.00		Grondwaterstand [m] : 10.00				
1	11.00	8.25	Zand - Schoon - Matig	1.0	100.0		
2	8.25	7.45	Zand - Schoon - Vast	1.0	100.0		
3	7.45	3.15	Zand - Zwak siltig - Kleiig	1.0	100.0		
4	3.15	1.15	Zand - Sterk siltig - Kleiig	1.0	100.0		
5	1.15	-3.95	Zand - Zwak siltig - Kleiig	1.0	100.0		
6	-3.95	-4.25	Zand - Schoon - Vast	1.0	100.0		
7	-4.25	-5.35	Zand - Sterk siltig - Kleiig	1.0	100.0		
8	-5.35	-13.16	Zand - Schoon - Matig	1.0	100.0		
9	-13.16	-16.89	Zand - Schoon - Vast	1.0	100.0		
10	-16.89	-18.28	Zand - Schoon - Los	1.0	100.0		
11	-18.28	-23.93	Zand - Schoon - Vast	1.0	100.0		

BODEMPROFIELGEGEVENS: 166.S01

Alle niveaus/hoogtes/peilmaten zijn t.o.v.: N.A.P.

d50-reductie is meegenomen overeenkomstig NEN-EN 9997 art. 7.6.2.3 (i)

Laag	Van [m]	Tot [m]	Omschrijving	OCR	Aandeel pos. kleef [%]	α_s	d_{50} [mm]
	Hoogte maaiveld [m] : 3.45		Grondwaterstand [m] : 2.45				
1	3.45	1.40	Zand - Schoon - Vast	1.0	100.0		
2	1.40	0.60	Zand - Zwak siltig - Kleiig	1.0	100.0		
3	0.60	-1.60	Klei - Zwak zandig - Vast	1.0	50.0		
4	-1.60	-3.40	Zand - Sterk siltig - Kleiig	1.0	100.0		
5	-3.40	-3.60	Klei - Zwak zandig - Vast	1.0	50.0		
6	-3.60	-4.90	Zand - Sterk siltig - Kleiig	1.0	100.0		
7	-4.90	-11.10	Zand - Schoon - Matig	1.0	100.0		
8	-11.10	-11.70	Zand - Schoon - Vast	1.0	100.0		
9	-11.70	-13.21	Zand - Schoon - Los	1.0	100.0		
10	-13.21	-21.31	Zand - Schoon - Matig	1.0	100.0		
11	-21.31	-22.66	Zand - Schoon - Vast	1.0	100.0		

BODEMPROFIELGEGEVENS: 19-1008_11

Alle niveaus/hoogtes/peilmaten zijn t.o.v.: N.A.P.

d50-reductie is meegenomen overeenkomstig NEN-EN 9997 art. 7.6.2.3 (i)

Laag	Van [m]	Tot [m]	Omschrijving	OCR	Aandeel pos. kleef [%]	α_s	d_{50} [mm]
	Hoogte maaiveld [m] : 0.62		Grondwaterstand [m] : -0.38				
1	0.62	-0.83	Zand - Schoon - Matig	1.0	100.0		
2	-0.83	-2.83	Zand - Sterk siltig - Kleiig	1.0	100.0		
3	-2.83	-4.13	Klei - Schoon - Vast	1.0	50.0		
4	-4.13	-7.43	Klei - Zwak zandig - Vast	1.0	50.0		
5	-7.43	-11.82	Zand - Sterk siltig - Kleiig	1.0	100.0		
6	-11.82	-12.64	Klei - Schoon - Matig	1.0	50.0		
7	-12.64	-17.92	Zand - Zwak siltig - Kleiig	1.0	100.0		
8	-17.92	-22.71	Zand - Schoon - Matig	1.0	100.0		
9	-22.71	-25.46	Zand - Schoon - Los	1.0	100.0		
10	-25.46	-29.39	Zand - Schoon - Matig	1.0	100.0		
11	-29.39	-32.78	Zand - Schoon - Vast	1.0	100.0		
12	-32.78	-33.83	Zand - Schoon - Matig	1.0	100.0		
13	-33.83	-34.28	Zand - Schoon - Los	1.0	100.0		

Project : ZWO380 Funderingen
Onderdeel : RLL-TBG380

BODEMPROFIELGEGEVENS: 19-1008 12

Alle niveaus/hoogtes/peilmaten zijn t.o.v.: N.A.P.

d50-reductie is meegenomen overeenkomstig NEN-EN 9997 art. 7.6.2.3 (i)

Laag	Hoogte maaiveld [m]		Omschrijving	Grondwaterstand [m]	OCR	Aandeel pos. kleef [%]	α_s	d_{50} [mm]
	Van [m]	Tot [m]						
1	3.57	1.12	Zand - Schoon - Matig		1.0	100.0		
2	1.12	0.72	Zand - Schoon - Los		1.0	100.0		
3	0.72	-3.28	Zand - Zwak siltig - Kleiig		1.0	100.0		
4	-3.28	-3.68	Zand - Schoon - Vast		1.0	100.0		
5	-3.68	-6.38	Zand - Schoon - Los		1.0	100.0		
6	-6.38	-7.58	Zand - Schoon - Vast		1.0	100.0		
7	-7.58	-8.48	Zand - Schoon - Los		1.0	100.0		
8	-8.48	-19.19	Klei - Zwak zandig - Matig		1.0	50.0		
9	-19.19	-25.26	Zand - Schoon - Matig		1.0	100.0		
10	-25.26	-27.97	Klei - Zwak zandig - Vast		1.0	50.0		
11	-27.97	-30.88	Zand - Schoon - Matig		1.0	100.0		
12	-30.88	-31.50	Zand - Schoon - Los		1.0	100.0		

BODEMPROFIELGEGEVENS: 19-1008 17

Alle niveaus/hoogtes/peilmaten zijn t.o.v.: N.A.P.

d50-reductie is meegenomen overeenkomstig NEN-EN 9997 art. 7.6.2.3 (i)

Laag	Hoogte maaiveld [m]		Omschrijving	Grondwaterstand [m]	OCR	Aandeel pos. kleef [%]	α_s	d_{50} [mm]
	Van [m]	Tot [m]						
1	0.20	-0.85	Zand - Schoon - Matig		1.0	100.0		
2	-0.85	-2.95	Klei - Schoon - Matig		1.0	50.0		
3	-2.95	-4.05	Klei - Schoon - Vast		1.0	50.0		
4	-4.05	-4.95	Zand - Sterk siltig - Kleiig		1.0	100.0		
5	-4.95	-5.15	Klei - Zwak zandig - Vast		1.0	50.0		
6	-5.15	-6.65	Klei - Zwak zandig - Matig		1.0	50.0		
7	-6.65	-7.25	Zand - Schoon - Matig		1.0	100.0		
8	-7.25	-9.65	Klei - Schoon - Matig		1.0	50.0		
9	-9.65	-10.05	Zand - Zwak siltig - Kleiig		1.0	100.0		
10	-10.05	-10.25	Klei - Zwak zandig - Vast		1.0	50.0		
11	-10.25	-11.55	Zand - Schoon - Matig		1.0	100.0		
12	-11.55	-12.85	Zand - Schoon - Vast		1.0	100.0		
13	-12.85	-14.75	Zand - Schoon - Los		1.0	100.0		
14	-14.75	-17.25	Zand - Schoon - Matig		1.0	100.0		
15	-17.25	-18.55	Leem - Zwak zandig - Vast		1.0	50.0		
16	-18.55	-20.64	Zand - Sterk siltig - Kleiig		1.0	100.0		
17	-20.64	-21.14	Zand - Schoon - Matig		1.0	100.0		
18	-21.14	-21.54	Klei - Zwak zandig - Vast		1.0	50.0		
19	-21.54	-24.23	Zand - Schoon - Matig		1.0	100.0		
20	-24.23	-28.91	Zand - Schoon - Los		1.0	100.0		
21	-28.91	-29.73	Klei - Organisch - Matig		1.0	50.0		
22	-29.73	-30.67	Zand - Schoon - Vast		1.0	100.0		
23	-30.67	-34.80	Zand - Zwak siltig - Kleiig		1.0	100.0		

BODEMPROFIELGEGEVENS: 19-1008 20

Alle niveaus/hoogtes/peilmaten zijn t.o.v.: N.A.P.

d50-reductie is meegenomen overeenkomstig NEN-EN 9997 art. 7.6.2.3 (i)

Laag	Hoogte maaiveld [m]		Omschrijving	Grondwaterstand [m]	OCR	Aandeel pos. kleef [%]	α_s	d_{50} [mm]
	Van [m]	Tot [m]						
1	-0.03	-1.28	Zand - Schoon - Matig		1.0	100.0		
2	-1.28	-3.18	Klei - Zwak zandig - Slap		1.0	50.0		
3	-3.18	-4.88	Klei - Schoon - Matig		1.0	50.0		
4	-4.88	-9.78	Zand - Sterk siltig - Kleiig		1.0	100.0		
5	-9.78	-10.68	Klei - Zwak zandig - Matig		1.0	50.0		
6	-10.68	-11.38	Zand - Zwak siltig - Kleiig		1.0	100.0		
7	-11.38	-13.58	Klei - Zwak zandig - Matig		1.0	50.0		
8	-13.58	-14.38	Leem - Zwak zandig - Vast		1.0	50.0		
9	-14.38	-17.38	Klei - Zwak zandig - Matig		1.0	50.0		
10	-17.38	-19.68	Leem - Zwak zandig - Vast		1.0	50.0		
11	-19.68	-20.48	Zand - Schoon - Matig		1.0	100.0		
12	-20.48	-23.07	Klei - Zwak zandig - Vast		1.0	50.0		
13	-23.07	-30.25	Zand - Schoon - Los		1.0	100.0		
14	-30.25	-31.84	Zand - Zwak siltig - Kleiig		1.0	100.0		
15	-31.84	-32.83	Leem - Zwak zandig - Vast		1.0	50.0		
16	-32.83	-34.29	Klei - Schoon - Vast		1.0	50.0		
17	-34.29	-35.23	Klei - Schoon - Vast		1.0	50.0		

BODEMPROFIELGEGEVENS: 19-1008 21

Alle niveaus/hoogtes/peilmaten zijn t.o.v.: N.A.P.

d50-reductie is meegenomen overeenkomstig NEN-EN 9997 art. 7.6.2.3 (i)

Laag	Hoogte maaiveld [m]		Omschrijving	Grondwaterstand [m]	OCR	Aandeel pos. kleef [%]	α_s	d_{50} [mm]
	Van [m]	Tot [m]						
1	1.78	-1.17	Leem - Zwak zandig - Vast		1.0	50.0		
2	-1.17	-4.17	Klei - Schoon - Matig		1.0	50.0		
3	-4.17	-8.26	Zand - Zwak siltig - Kleiig		1.0	100.0		
4	-8.26	-12.28	Zand - Schoon - Los		1.0	100.0		
5	-12.28	-12.98	Leem - Zwak zandig - Vast		1.0	50.0		
6	-12.98	-14.68	Zand - Sterk siltig - Kleiig		1.0	100.0		
7	-14.68	-16.58	Leem - Zwak zandig - Vast		1.0	50.0		
8	-16.58	-17.88	Klei - Schoon - Matig		1.0	50.0		
9	-17.88	-18.88	Klei - Zwak zandig - Vast		1.0	50.0		
10	-18.88	-30.48	Klei - Schoon - Matig		1.0	50.0		
11	-30.48	-33.19	Zand - Zwak siltig - Kleiig		1.0	100.0		

Project : ZWO380 Funderingen
Onderdeel : RLL-TBG380

BODEMPROFIELGEGEVENS: 251.S01

Alle niveaus/hogtes/peilmaten zijn t.o.v.: N.A.P.

d50-reductie is meegenomen overeenkomstig NEN-EN 9997 art. 7.6.2.3 (i)

Laag	Hoogte maaiveld [m]		Omschrijving	Grondwaterstand [m]	OCR	Aandeel pos. kleef [%]	α_s	d_{50} [mm]
	Van [m]	Tot [m]						
1	-1.05	-3.60	Klei - Schoon - Matig		1.0	50.0		
2	-3.60	-7.80	Zand - Zwak siltig - Kleilig	-2.05	1.0	100.0		
3	-7.80	-9.10	Klei - Organisch - Matig		1.0	50.0		
4	-9.10	-14.80	Zand - Sterk siltig - Kleilig		1.0	100.0		
5	-14.80	-15.40	Klei - Schoon - Matig		1.0	50.0		
6	-15.40	-18.31	Zand - Schoon - Matig		1.0	100.0		
7	-18.31	-19.21	Leem - Zwak zandig - Vast		1.0	50.0		
8	-19.21	-20.23	Zand - Sterk siltig - Kleilig		1.0	100.0		
9	-20.23	-26.29	Klei - Zwak zandig - Vast		1.0	50.0		
10	-26.29	-28.61	Zand - Schoon - Vast		1.0	100.0		
11	-28.61	-30.30	Zand - Schoon - Los		1.0	100.0		
12	-30.30	-33.03	Klei - Zwak zandig - Matig		1.0	50.0		
13	-33.03	-37.54	Zand - Sterk siltig - Kleilig		1.0	100.0		
14	-37.54	-38.23	Klei - Schoon - Vast		1.0	50.0		
15	-38.23	-40.24	Zand - Sterk siltig - Kleilig		1.0	100.0		
16	-40.24	-40.88	Zand - Schoon - Los		1.0	100.0		

BODEMPROFIELGEGEVENS: 19-1008_29

Alle niveaus/hogtes/peilmaten zijn t.o.v.: N.A.P.

d50-reductie is meegenomen overeenkomstig NEN-EN 9997 art. 7.6.2.3 (i)

Laag	Hoogte maaiveld [m]		Omschrijving	Grondwaterstand [m]	OCR	Aandeel pos. kleef [%]	α_s	d_{50} [mm]
	Van [m]	Tot [m]						
1	0.79	-2.26	Zand - Sterk siltig - Kleilig	-0.21	1.0	100.0		
2	-2.26	-11.15	Zand - Zwak siltig - Kleilig		1.0	100.0		
3	-11.15	-12.15	Klei - Organisch - Matig		1.0	50.0		
4	-12.15	-12.85	Zand - Schoon - Matig		1.0	100.0		
5	-12.85	-15.55	Klei - Zwak zandig - Matig		1.0	50.0		
6	-15.55	-15.75	Zand - Schoon - Vast		1.0	100.0		
7	-15.75	-17.65	Klei - Zwak zandig - Matig		1.0	50.0		
8	-17.65	-18.98	Zand - Schoon - Matig		1.0	100.0		
9	-18.98	-19.38	Leem - Zwak zandig - Vast		1.0	50.0		
10	-19.38	-22.38	Zand - Schoon - Matig		1.0	100.0		
11	-22.38	-23.98	Klei - Zwak zandig - Matig		1.0	50.0		
12	-23.98	-24.18	Zand - Sterk siltig - Kleilig		1.0	100.0		
13	-24.18	-29.47	Klei - Zwak zandig - Matig		1.0	50.0		
14	-29.47	-30.99	Zand - Sterk siltig - Kleilig		1.0	100.0		
15	-30.99	-34.29	Leem - Zwak zandig - Vast		1.0	50.0		

BODEMPROFIELGEGEVENS: 283.S02

Alle niveaus/hogtes/peilmaten zijn t.o.v.: N.A.P.

d50-reductie is meegenomen overeenkomstig NEN-EN 9997 art. 7.6.2.3 (i)

Laag	Hoogte maaiveld [m]		Omschrijving	Grondwaterstand [m]	OCR	Aandeel pos. kleef [%]	α_s	d_{50} [mm]
	Van [m]	Tot [m]						
1	0.17	-1.58	Klei - Zwak zandig - Slap	-0.83	1.0	0.0		
2	-1.58	-15.18	Zand - Schoon - Los		1.0	100.0		
3	-15.18	-26.29	Zand - Schoon - Matig		1.0	100.0		
4	-26.29	-28.61	Klei - Schoon - Vast		1.0	50.0		
5	-28.61	-30.60	Klei - Schoon - Matig		1.0	50.0		
6	-30.60	-32.29	Zand - Schoon - Matig		1.0	100.0		

BODEMPROFIELGEGEVENS: 19-1008_35

Alle niveaus/hogtes/peilmaten zijn t.o.v.: N.A.P.

d50-reductie is meegenomen overeenkomstig NEN-EN 9997 art. 7.6.2.3 (i)

Laag	Hoogte maaiveld [m]		Omschrijving	Grondwaterstand [m]	OCR	Aandeel pos. kleef [%]	α_s	d_{50} [mm]
	Van [m]	Tot [m]						
1	0.92	-0.23	Klei - Zwak zandig - Matig	-0.08	1.0	50.0		
2	-0.23	-19.34	Zand - Schoon - Los		1.0	100.0		
3	-19.34	-25.33	Zand - Schoon - Matig		1.0	100.0		
4	-25.33	-25.93	Leem - Zwak zandig - Vast		1.0	50.0		
5	-25.93	-28.72	Zand - Schoon - Matig		1.0	100.0		
6	-28.72	-30.64	Zand - Schoon - Vast		1.0	100.0		
7	-30.64	-34.25	Klei - Schoon - Matig		1.0	50.0		

BODEMPROFIELGEGEVENS: 312.S03

Alle niveaus/hogtes/peilmaten zijn t.o.v.: N.A.P.

d50-reductie is meegenomen overeenkomstig NEN-EN 9997 art. 7.6.2.3 (i)

Laag	Hoogte maaiveld [m]		Omschrijving	Grondwaterstand [m]	OCR	Aandeel pos. kleef [%]	α_s	d_{50} [mm]
	Van [m]	Tot [m]						
1	3.78	-3.57	Zand - Schoon - Los	2.78	1.0	100.0		
2	-3.57	-4.86	Zand - Schoon - Matig		1.0	100.0		
3	-4.86	-6.86	Zand - Schoon - Los		1.0	100.0		
4	-6.86	-7.85	Klei - Zwak zandig - Vast		1.0	50.0		
5	-7.85	-20.13	Zand - Zwak siltig - Kleilig		1.0	100.0		
6	-20.13	-20.47	Klei - Organisch - Slap		1.0	50.0		
7	-20.47	-27.08	Zand - Zwak siltig - Kleilig		1.0	100.0		
8	-27.08	-31.92	Klei - Zwak zandig - Matig		1.0	50.0		
9	-31.92	-31.97	Zand - Schoon - Vast		1.0	100.0		

Project : ZWO380 Funderingen
 Onderdeel : RLL-TBG380

BODEMPROFIELGEGEVENS: 19-1008_43

Alle niveaus/hoogtes/peilmaten zijn t.o.v.: N.A.P.

d50-reductie is meegenomen overeenkomstig NEN-EN 9997 art. 7.6.2.3 (i)

Laag	Van [m]	Tot [m]	Omschrijving	OCR	Aandeel pos. kleef [%]	α_s	d_{50} [mm]
1	9.88	4.60	Zand - Schoon - Vast	1.0	100.0		
2	4.60	4.00	Klei - Zwak zandig - Matig	1.0	50.0		
3	4.00	3.40	Zand - Sterk siltig - Kleiig	1.0	100.0		
4	3.40	3.00	Klei - Zwak zandig - Vast	1.0	50.0		
5	3.00	-6.39	Zand - Sterk siltig - Kleiig	1.0	100.0		
6	-6.39	-10.29	Zand - Zwak siltig - Kleiig	1.0	100.0		
7	-10.29	-12.28	Zand - Schoon - Matig	1.0	100.0		
8	-12.28	-14.98	Zand - Schoon - Los	1.0	100.0		
9	-14.98	-16.30	Zand - Schoon - Matig	1.0	100.0		
10	-16.30	-18.73	Zand - Schoon - Los	1.0	100.0		
11	-18.73	-21.25	Leem - Zwak zandig - Vast	1.0	50.0		
12	-21.25	-25.16	Zand - Schoon - Matig	1.0	100.0		

BODEMPROFIELGEGEVENS: 328.S02

Alle niveaus/hoogtes/peilmaten zijn t.o.v.: N.A.P.

d50-reductie is meegenomen overeenkomstig NEN-EN 9997 art. 7.6.2.3 (i)

Laag	Van [m]	Tot [m]	Omschrijving	OCR	Aandeel pos. kleef [%]	α_s	d_{50} [mm]
1	10.17	5.82	Zand - Zwak siltig - Kleiig	1.0	100.0		
2	5.82	-0.06	Zand - Schoon - Vast	1.0	100.0		
3	-0.06	-1.16	Zand - Schoon - Los	1.0	100.0		
4	-1.16	-1.56	Klei - Zwak zandig - Vast	1.0	50.0		
5	-1.56	-4.56	Zand - Schoon - Matig	1.0	100.0		
6	-4.56	-5.39	Klei - Zwak zandig - Matig	1.0	50.0		
7	-5.39	-15.50	Zand - Sterk siltig - Kleiig	1.0	100.0		
8	-15.50	-16.08	Leem - Zwak zandig - Vast	1.0	50.0		
9	-16.08	-17.81	Zand - Schoon - Matig	1.0	100.0		
10	-17.81	-18.39	Leem - Zwak zandig - Vast	1.0	50.0		
11	-18.39	-27.62	Zand - Zwak siltig - Kleiig	1.0	100.0		
12	-27.62	-28.07	Zand - Schoon - Los	1.0	100.0		
13	-28.07	-28.89	Zand - Sterk siltig - Kleiig	1.0	100.0		

SONDERINGSGEGEVENS ALGEMEEN: 19-1008_1

Alle niveaus/hoogtes/peilmaten zijn t.o.v.: N.A.P.

Hoogte maaiveld [m] : 2.12 Bodemprofiel: 19-1008_1

Traject negatieve kleef : 2.12 tot -4.90 [m]

Traject positieve kleef : -7.30 tot -32.70 [m]

Project : ZWO380 Funderingen
Onderdeel : RLL-TBG380

SONDERINGSGEGEVENS GRAFIEK: 19-1008 1

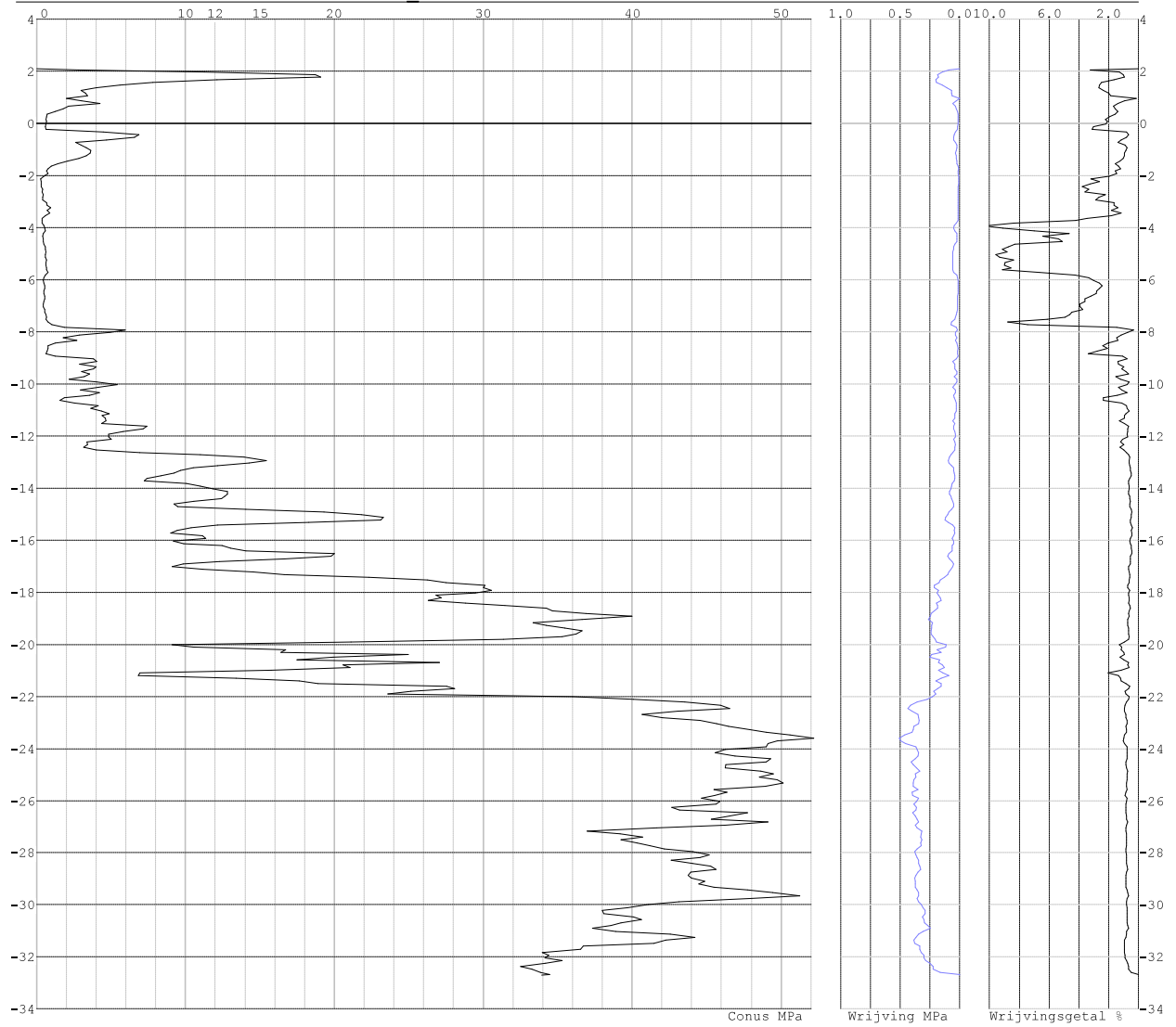

Project : ZWO380 Funderingen
Onderdeel : RLL-TBG380

SONDERINGSGEGEVENS ALGEMEEN: 19-1008_6

Alle niveaus/hoogtes/peilmaten zijn t.o.v.: N.A.P.
Hoogte maaiveld [m] : 11.00 Bodemprofiel: 19-1008_6
Traject negatieve kleeft : 11.00 tot 6.90 [m]
Traject positieve kleeft : 4.20 tot -23.93 [m]

SONDERINGSGEGEVENS GRAFIEK: 19-1008_6

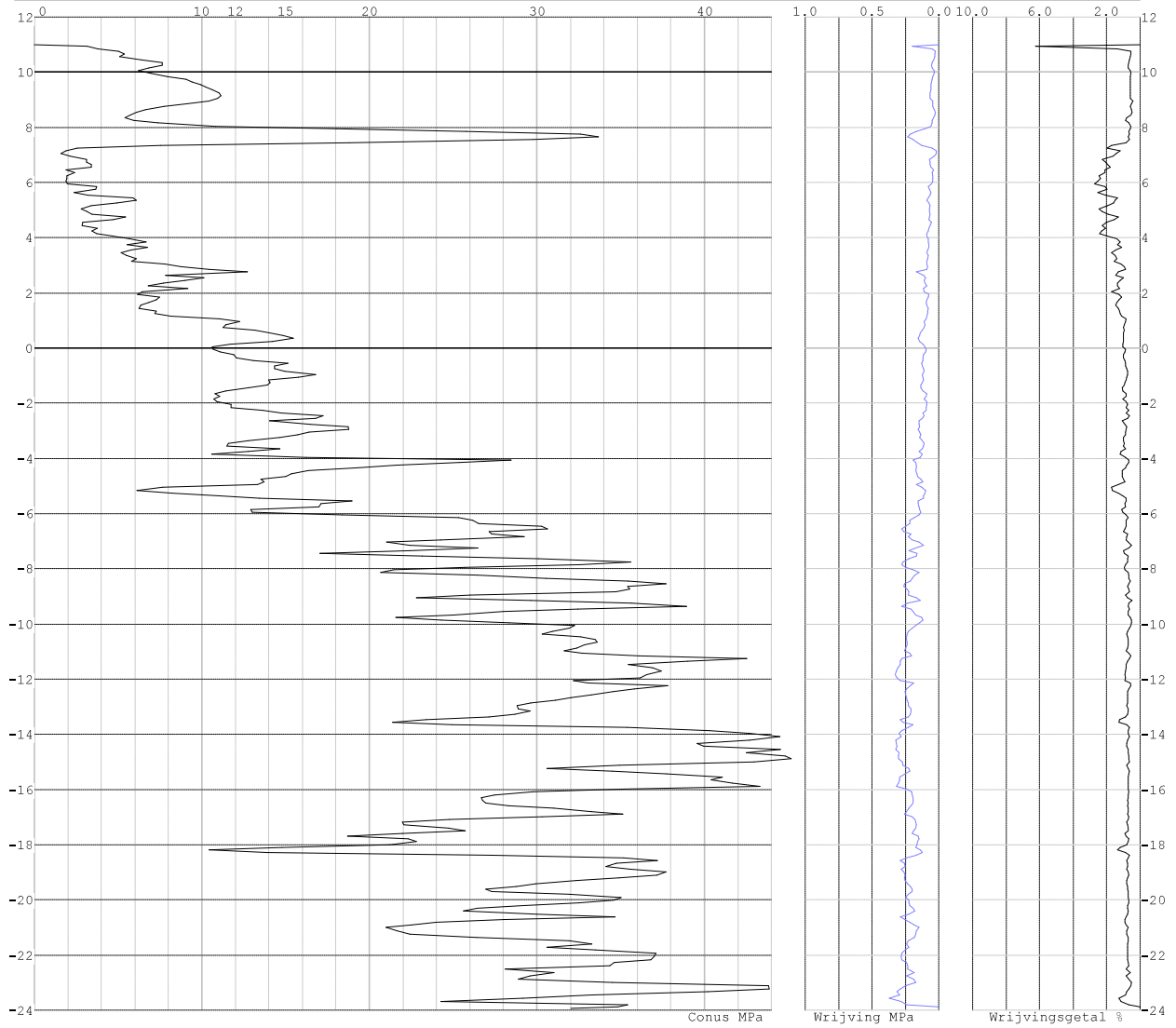

Project : ZWO380 Funderingen
Onderdeel : RLL-TBG380

SONDERINGSGEGEVENS ALGEMEEN: 166.S01

Alle niveaus/hoogtes/peilmaten zijn t.o.v.: N.A.P.
Hoogte maaiveld [m] : 3.45 Bodemprofiel: 166.S01
Traject negatieve kleeft : 3.45 tot -0.30 [m]
Traject positieve kleeft : -1.30 tot -22.66 [m]

SONDERINGSGEGEVENS GRAFIEK: 166.S01

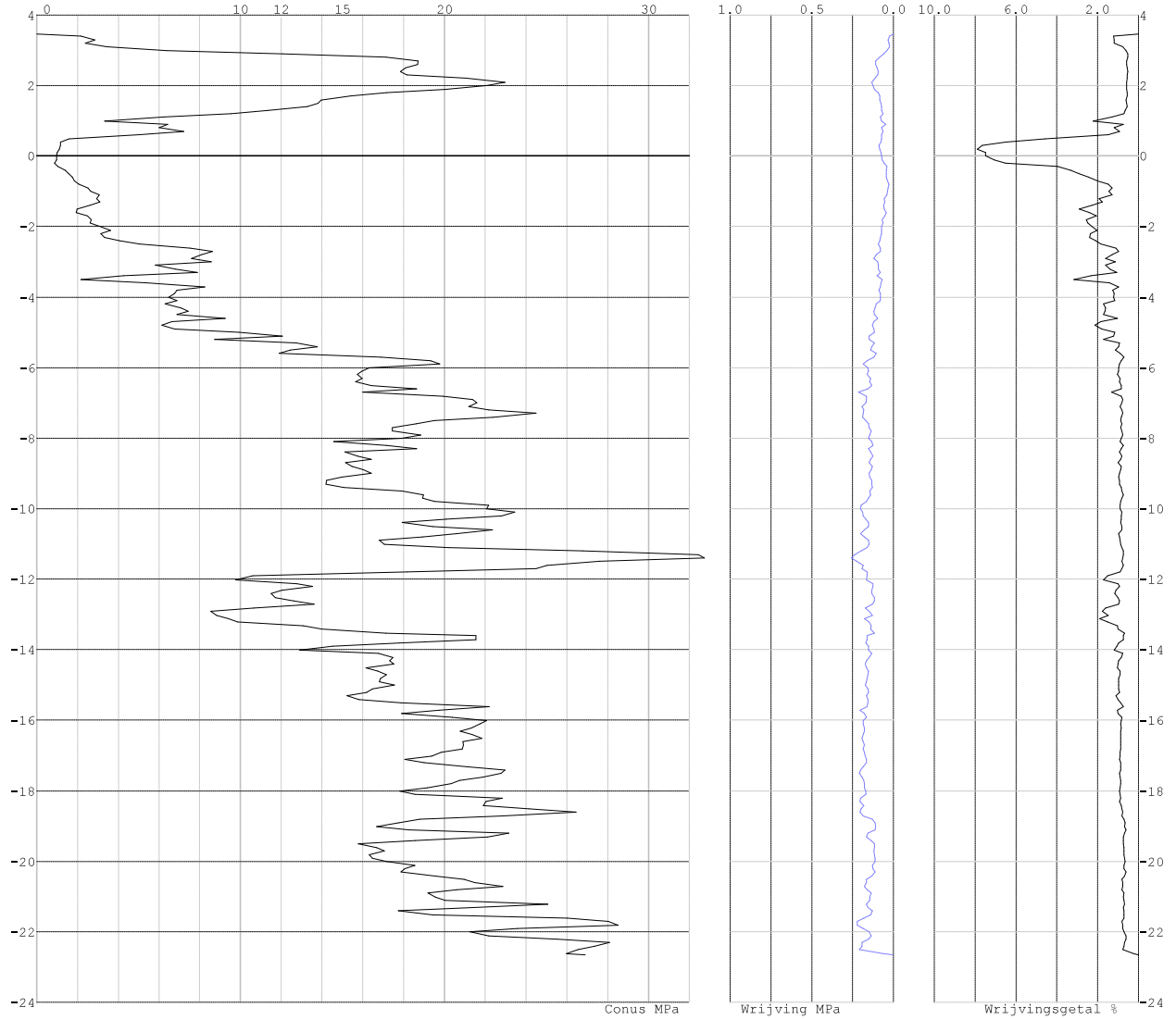

Project : ZWO380 Funderingen
Onderdeel : RLL-TBG380

SONDERINGSGEGEVENS ALGEMEEN: 19-1008_11

Alle niveaus/hoogtes/peilmaten zijn t.o.v.: N.A.P.
Hoogte maaiveld [m] : 0.62 Bodemprofiel: 19-1008_11
Traject negatieve kleef : 0.62 tot -5.20 [m]
Traject positieve kleef : -6.80 tot -34.28 [m]

SONDERINGSGEGEVENS GRAFIEK: 19-1008_11

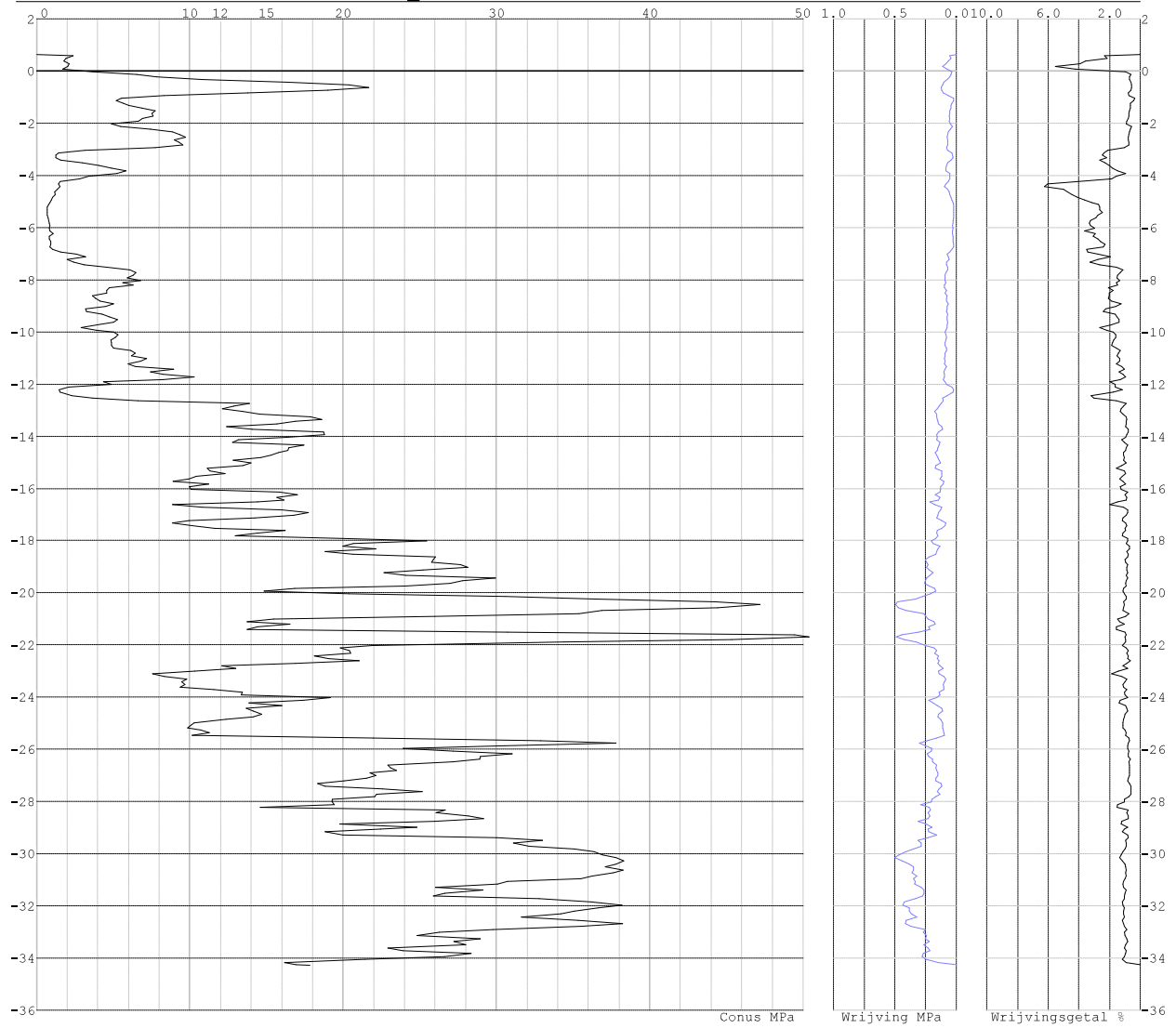

Project : ZWO380 Funderingen
Onderdeel : RLL-TBG380

SONDERINGSGEGEVENS ALGEMEEN: 19-1008_12

Alle niveaus/hoogtes/peilmaten zijn t.o.v.: N.A.P.
Hoogte maaiveld [m] : 3.57 Bodemprofiel: 19-1008_12
Traject negatieve kleeft : 3.57 tot 3.00 [m]
Traject positieve kleeft : 2.80 tot -31.50 [m]

SONDERINGSGEGEVENS GRAFIEK: 19-1008_12

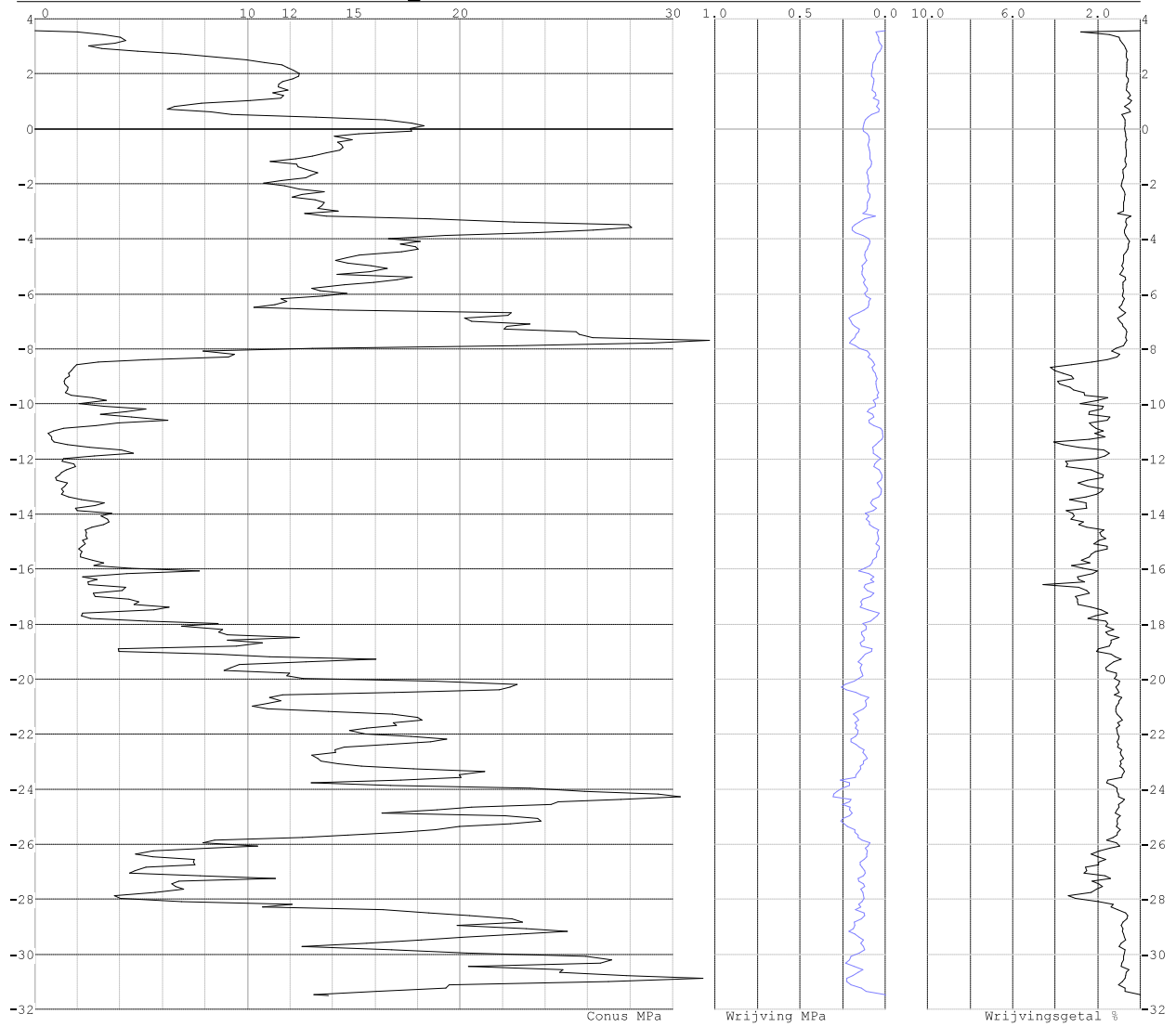

Project : ZWO380 Funderingen
Onderdeel : RLL-TBG380

SONDERINGSGEGEVENS ALGEMEEN: 19-1008_17

Alle niveaus/hoogtes/peilmaten zijn t.o.v.: N.A.P.
Hoogte maaiveld [m] : 0.20 Bodemprofiel: 19-1008_17
Traject negatieve kleeft : 0.20 tot -7.50 [m]
Traject positieve kleeft : -10.30 tot -34.80 [m]

SONDERINGSGEGEVENS GRAFIEK: 19-1008_17

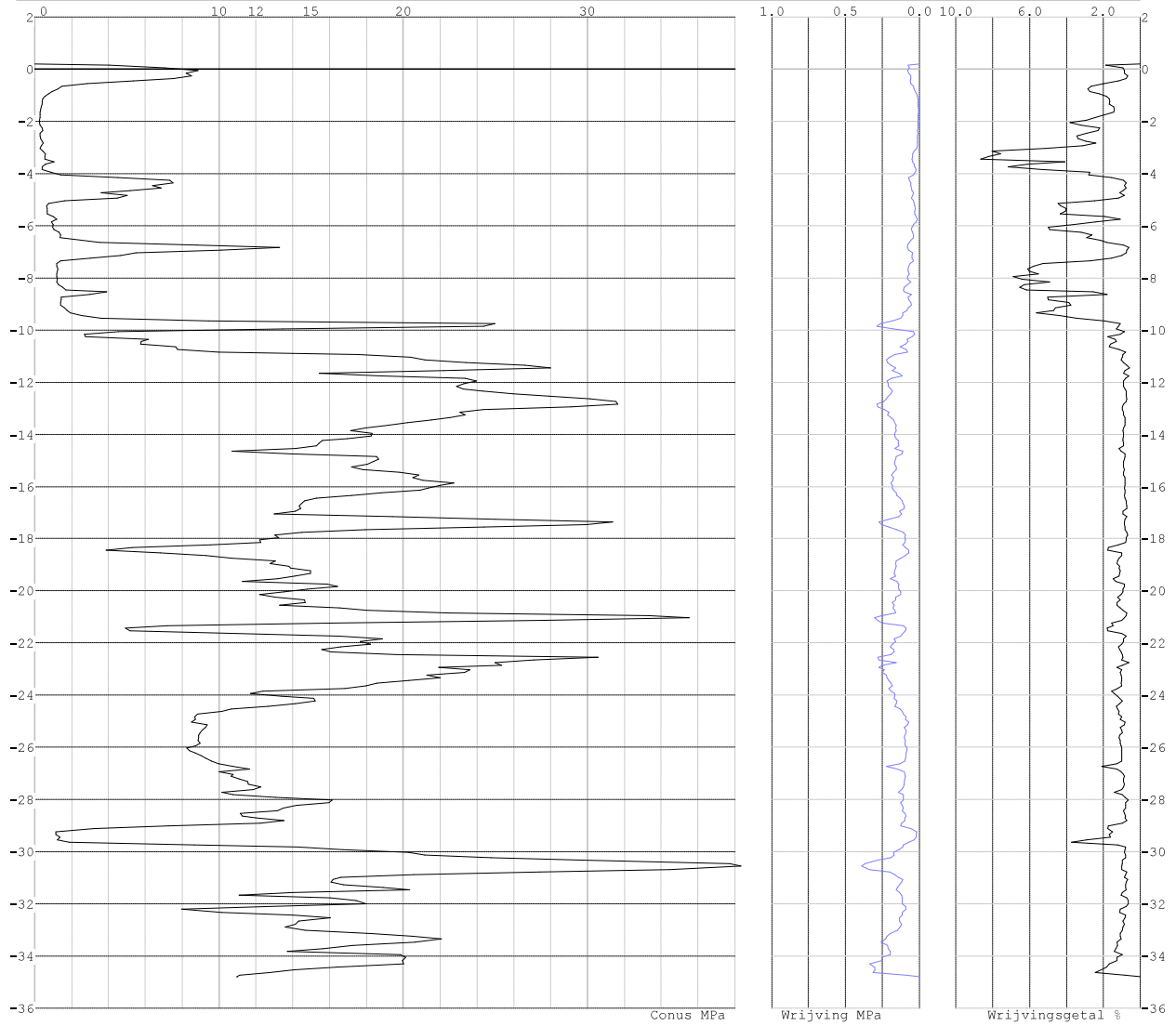

Project : ZWO380 Funderingen
Onderdeel : RLL-TBG380

SONDERINGSGEGEVENS ALGEMEEN: 19-1008_20

Alle niveaus/hoogtes/peilmaten zijn t.o.v.: N.A.P.
Hoogte maaiveld [m] : -0.03 Bodemprofiel: 19-1008_20
Traject negatieve kleeft : -0.03 tot -3.20 [m]
Traject positieve kleeft : -4.50 tot -35.23 [m]

SONDERINGSGEGEVENS GRAFIEK: 19-1008_20

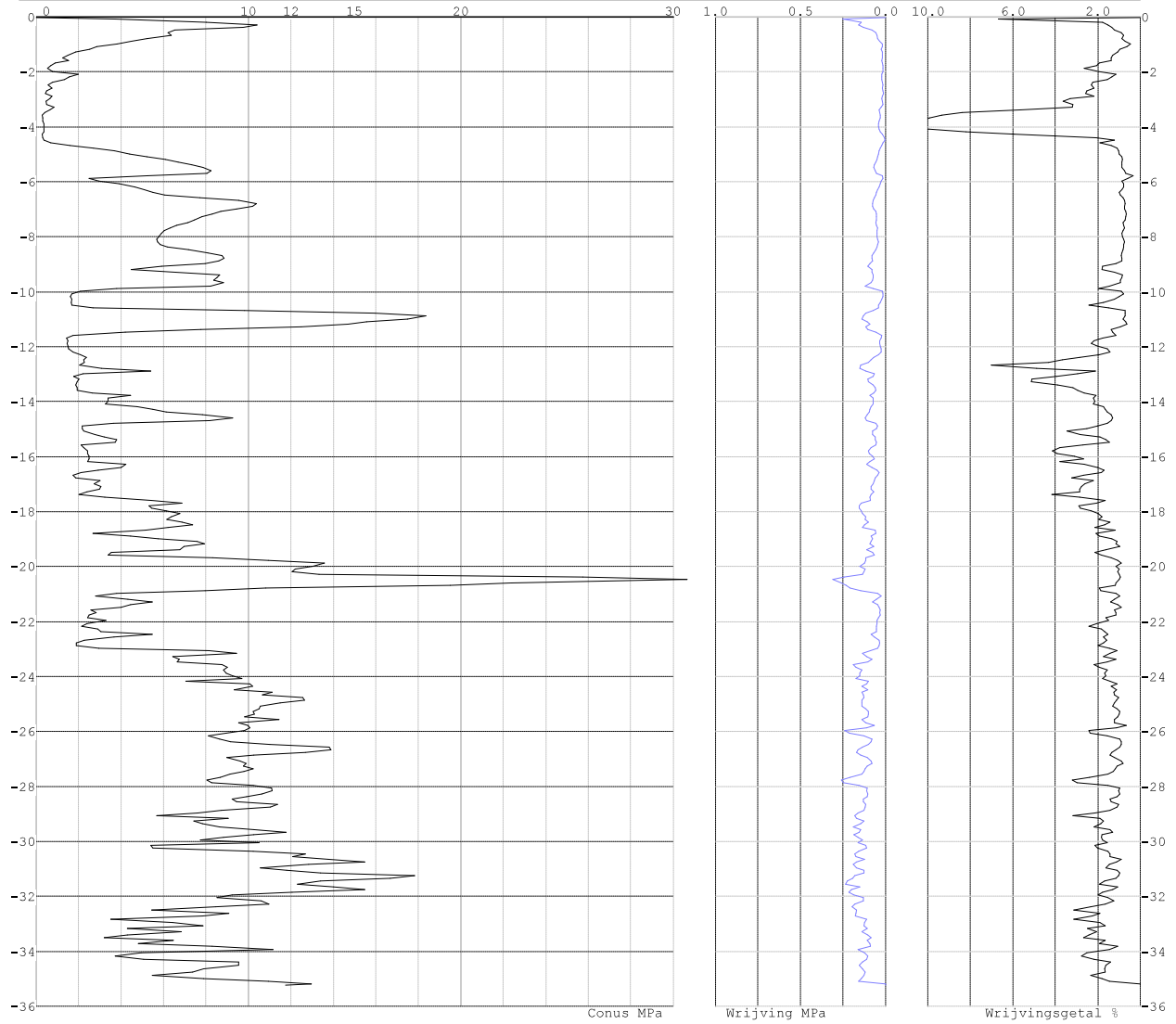

Project : ZWO380 Funderingen
Onderdeel : RLL-TBG380

SONDERINGSGEGEVENS ALGEMEEN: 19-1008_21

Alle niveaus/hoogtes/peilmaten zijn t.o.v.: N.A.P.
Hoogte maaiveld [m] : 1.78 Bodemprofiel: 19-1008_21
Traject negatieve kleeft : 1.78 tot -4.10 [m]
Traject positieve kleeft : -4.50 tot -33.19 [m]

SONDERINGSGEGEVENS GRAFIEK: 19-1008_21

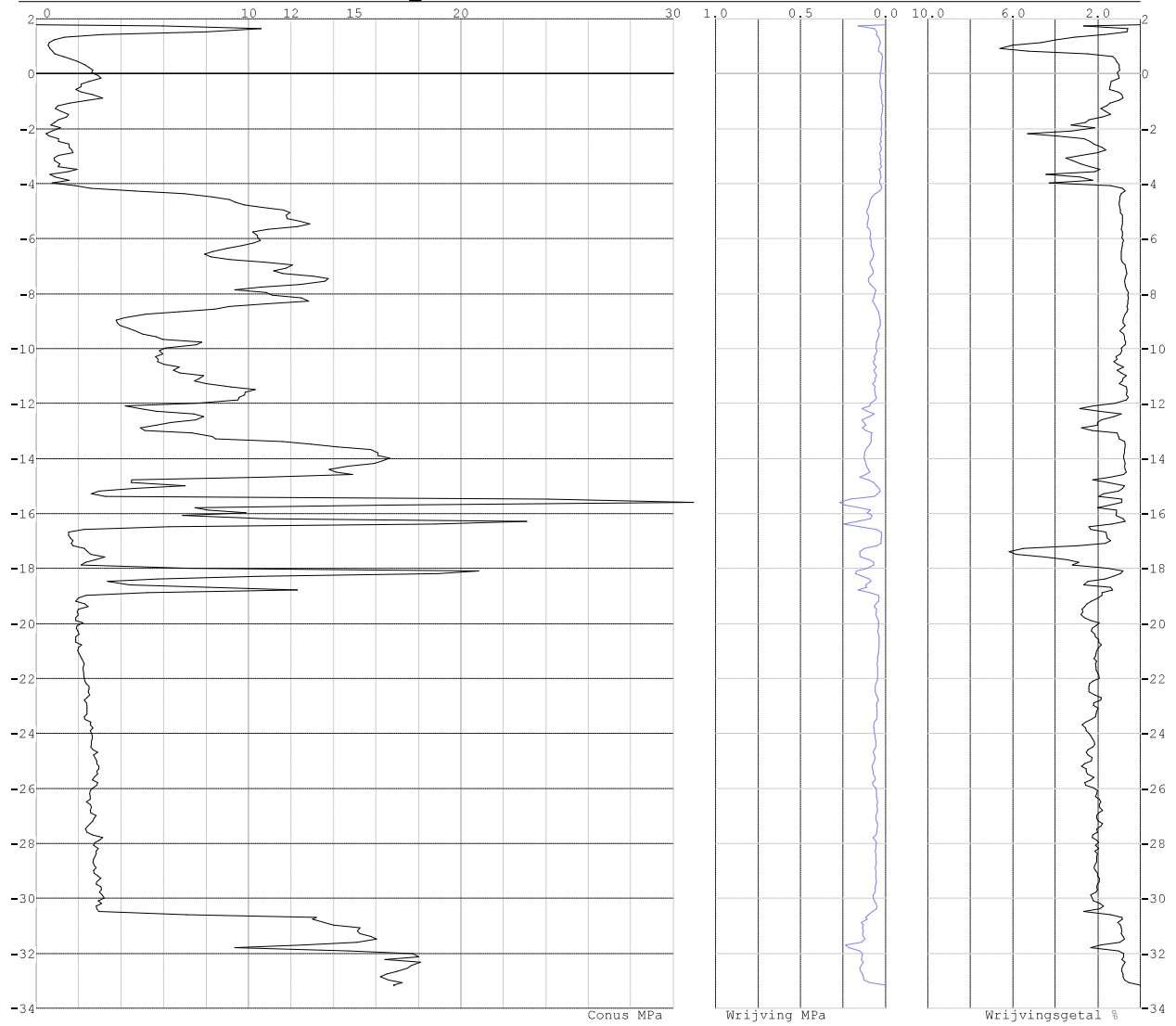

Project : ZWO380 Funderingen
Onderdeel : RLL-TBG380

SONDERINGSGEGEVENS ALGEMEEN: 251.S01

Alle niveaus/hoogtes/peilmaten zijn t.o.v.: N.A.P.
Hoogte maaiveld [m] : -1.05 Bodemprofiel: 251.S01
Traject negatieve kleeft : -1.05 tot -2.80 [m]
Traject positieve kleeft : -3.30 tot -40.88 [m]

SONDERINGSGEGEVENS GRAFIEK: 251.S01

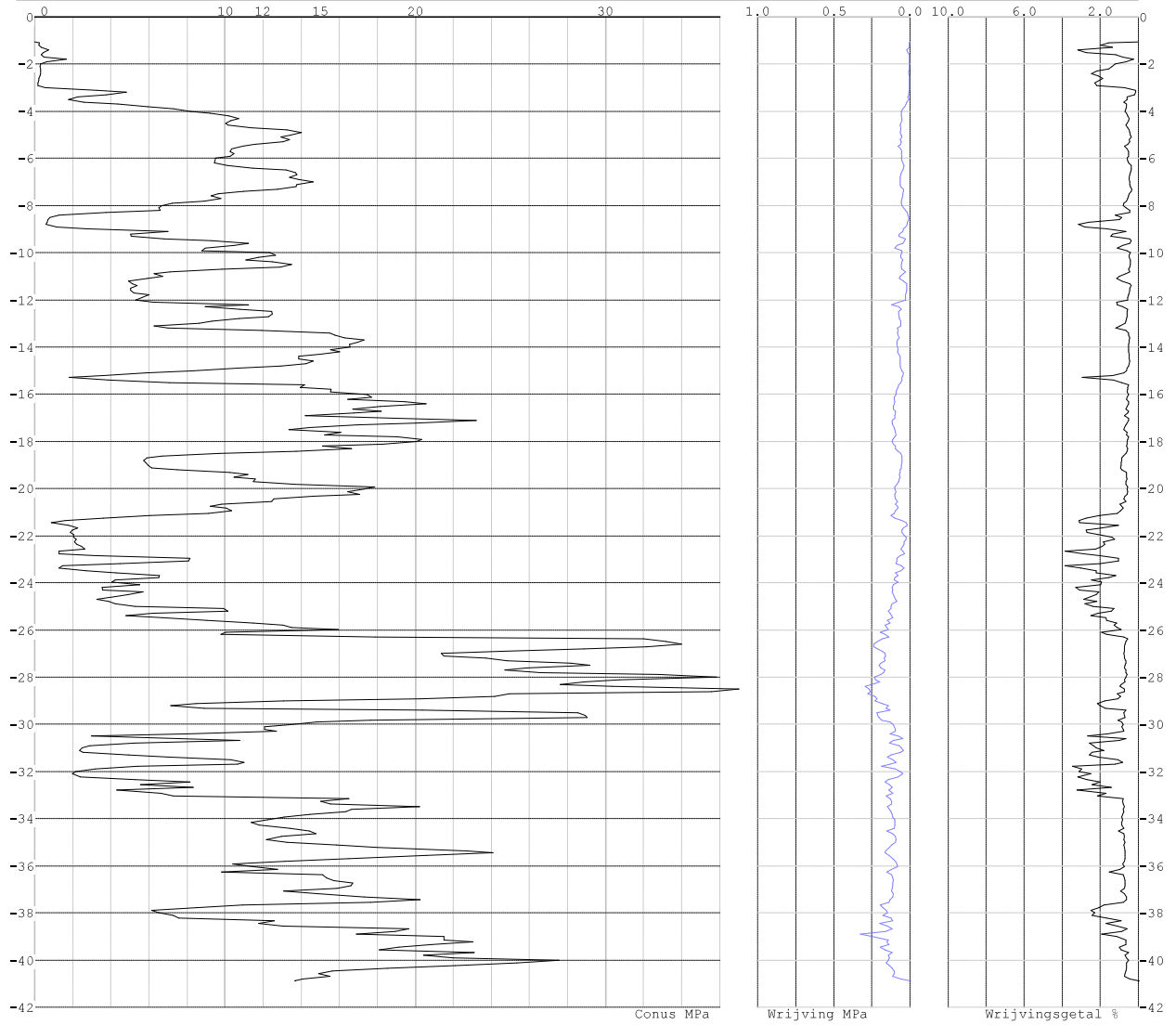

Project : ZWO380 Funderingen
Onderdeel : RLL-TBG380

SONDERINGSGEGEVENS ALGEMEEN: 19-1008_29

Alle niveaus/hoogtes/peilmaten zijn t.o.v.: N.A.P.
Hoogte maaiveld [m] : 0.79 Bodemprofiel: 19-1008_29
Traject negatieve kleeft : 0.79 tot -0.50 [m]
Traject positieve kleeft : -0.70 tot -34.29 [m]

SONDERINGSGEGEVENS GRAFIEK: 19-1008_29

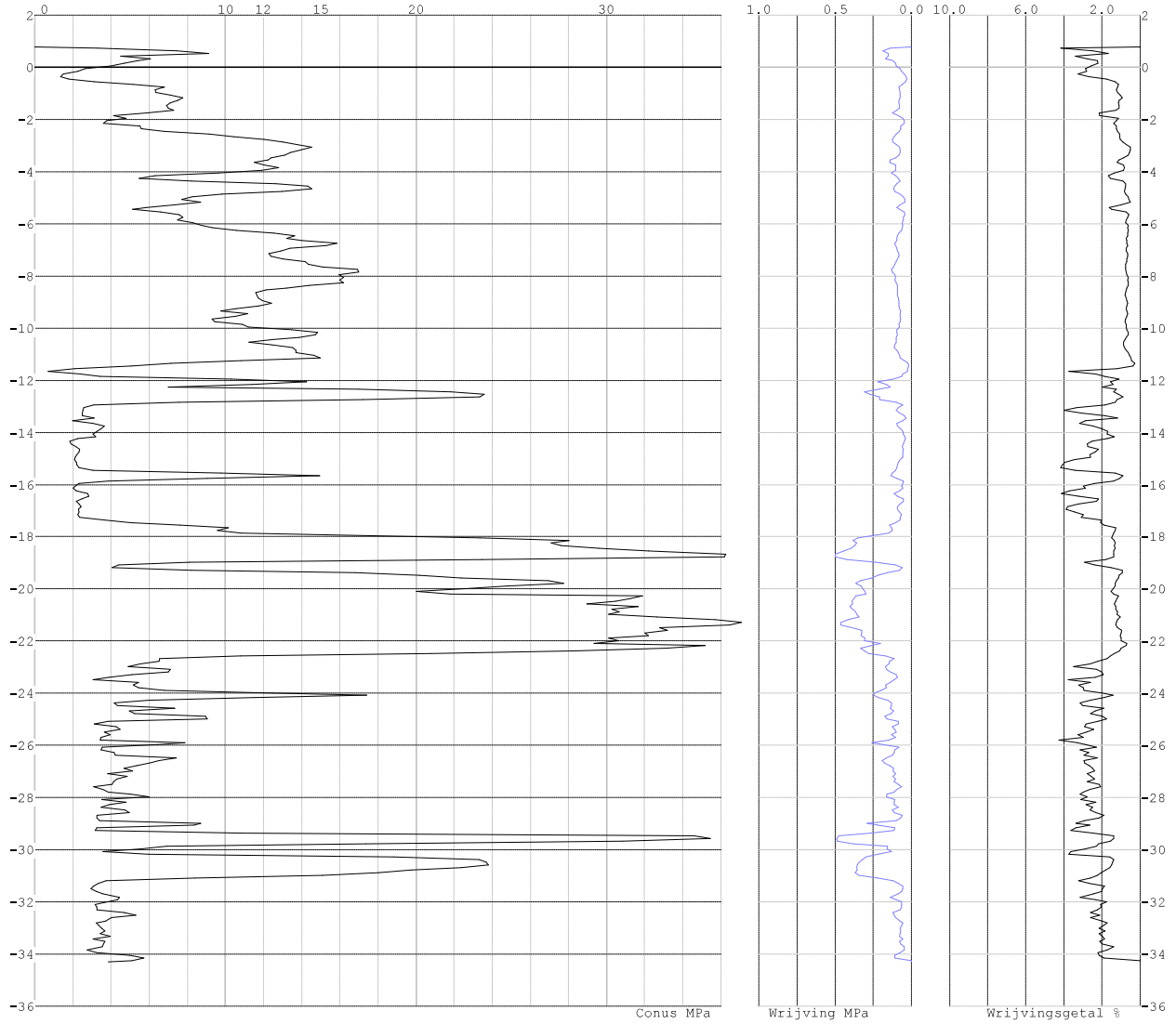

Project : ZWO380 Funderingen
Onderdeel : RLL-TBG380

SONDERINGSGEGEVENS ALGEMEEN: 283.S02

Alle niveaus/hoogtes/peilmaten zijn t.o.v.: N.A.P.
Hoogte maaiveld [m] : 0.17 Bodemprofiel: 283.S02
Traject negatieve kleef : 0.17 tot -1.60 [m]
Traject positieve kleef : -1.70 tot -32.29 [m]

SONDERINGSGEGEVENS GRAFIEK: 283.S02

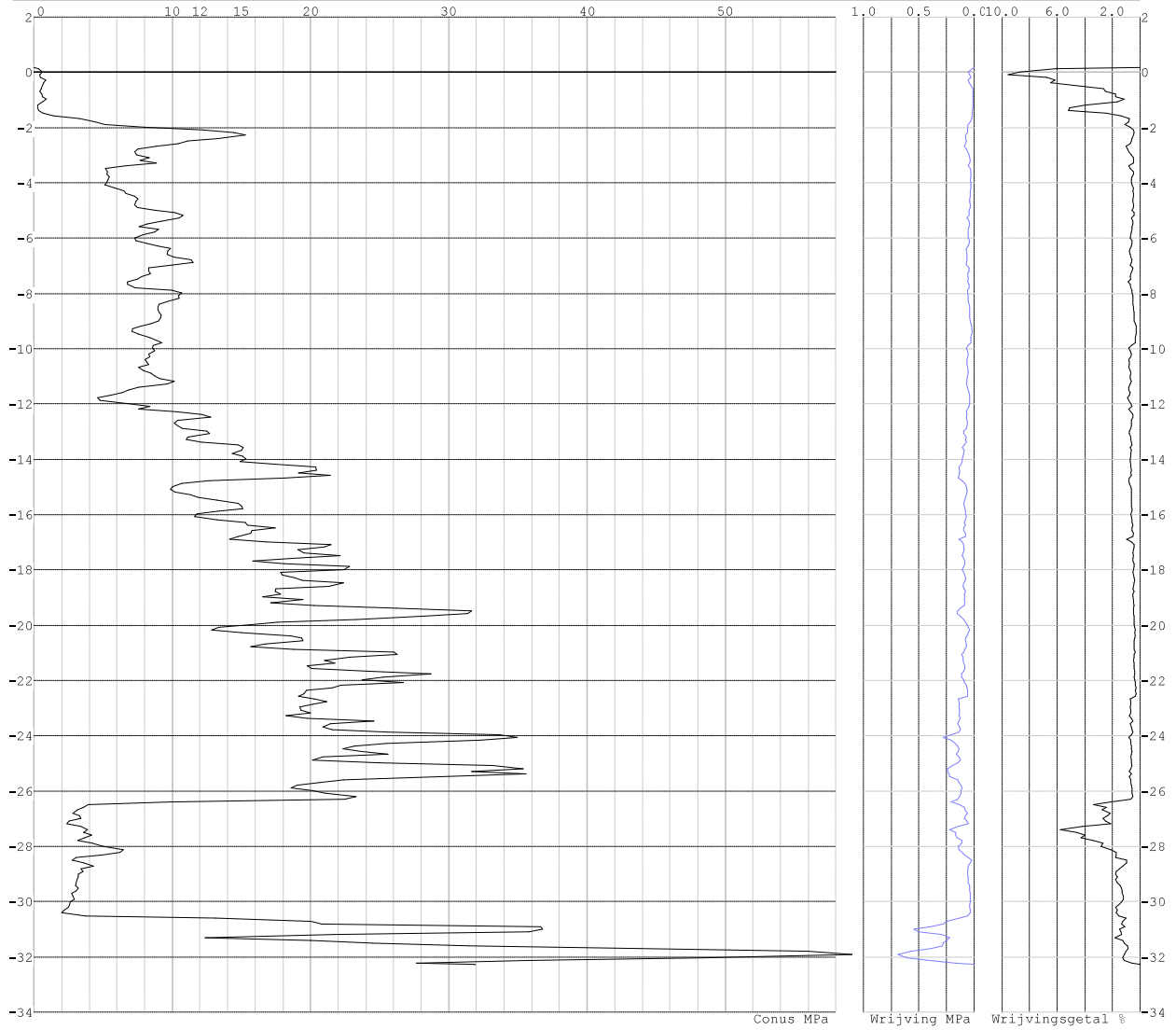

Project : ZWO380 Funderingen
Onderdeel : RLL-TBG380

SONDERINGSGEGEVENS ALGEMEEN: 19-1008_35

Alle niveaus/hoogtes/peilmaten zijn t.o.v.: N.A.P.
Hoogte maaiveld [m] : 0.92 Bodemprofiel: 19-1008_35
Traject negatieve kleeft : 0.92 tot -0.60 [m]
Traject positieve kleeft : -0.80 tot -34.25 [m]

SONDERINGSGEGEVENS GRAFIEK: 19-1008_35

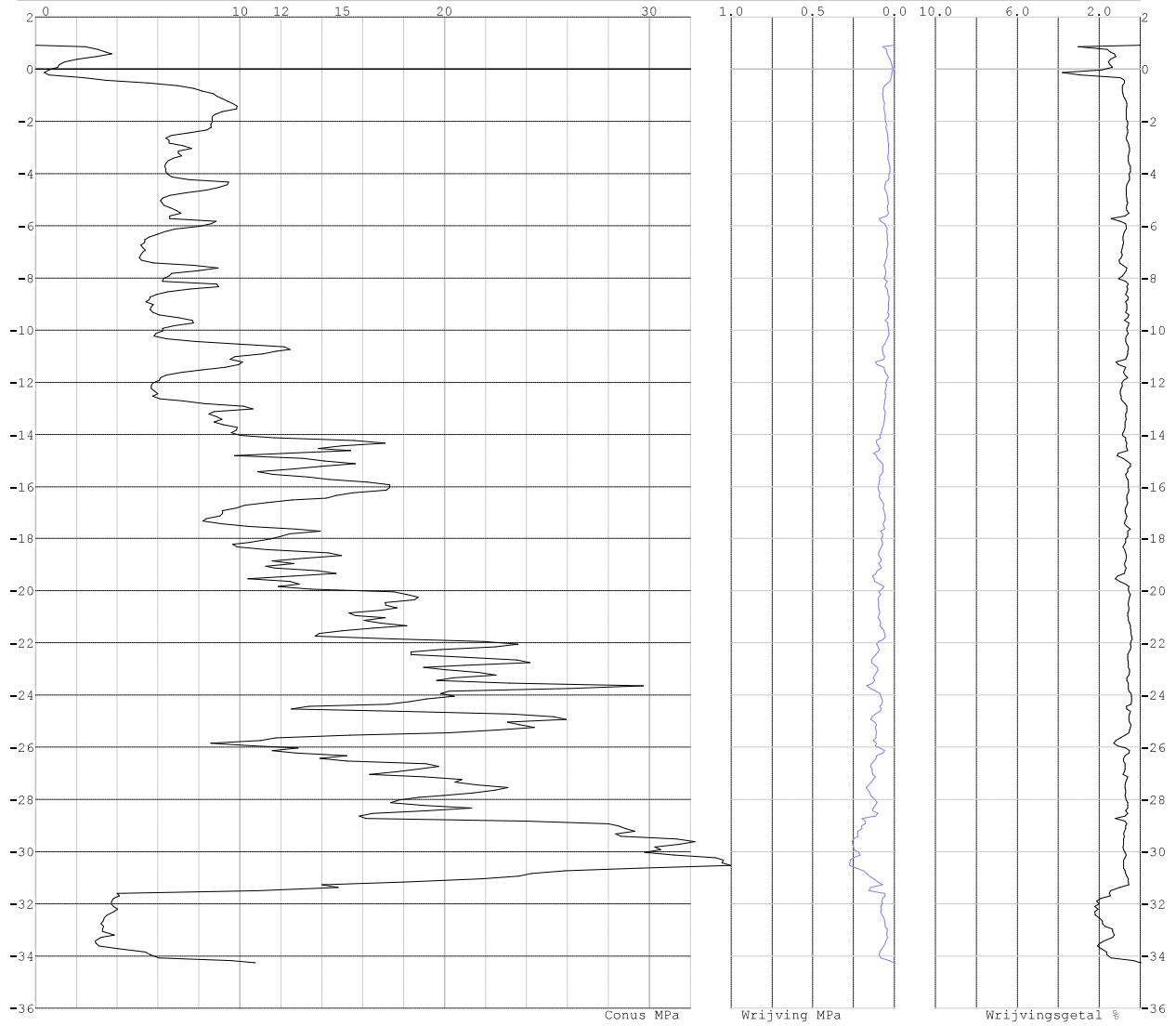

Project : ZWO380 Funderingen
Onderdeel : RLL-TBG380

SONDERINGSGEGEVENS ALGEMEEN: 312.S03

Alle niveaus/hoogtes/peilmaten zijn t.o.v.: N.A.P.
Hoogte maaiveld [m] : 3.78 Bodemprofiel: 312.S03
Traject negatieve kleeft : 3.78 tot 3.30 [m]
Traject positieve kleeft : 3.10 tot -31.97 [m]

SONDERINGSGEGEVENS GRAFIEK: 312.S03

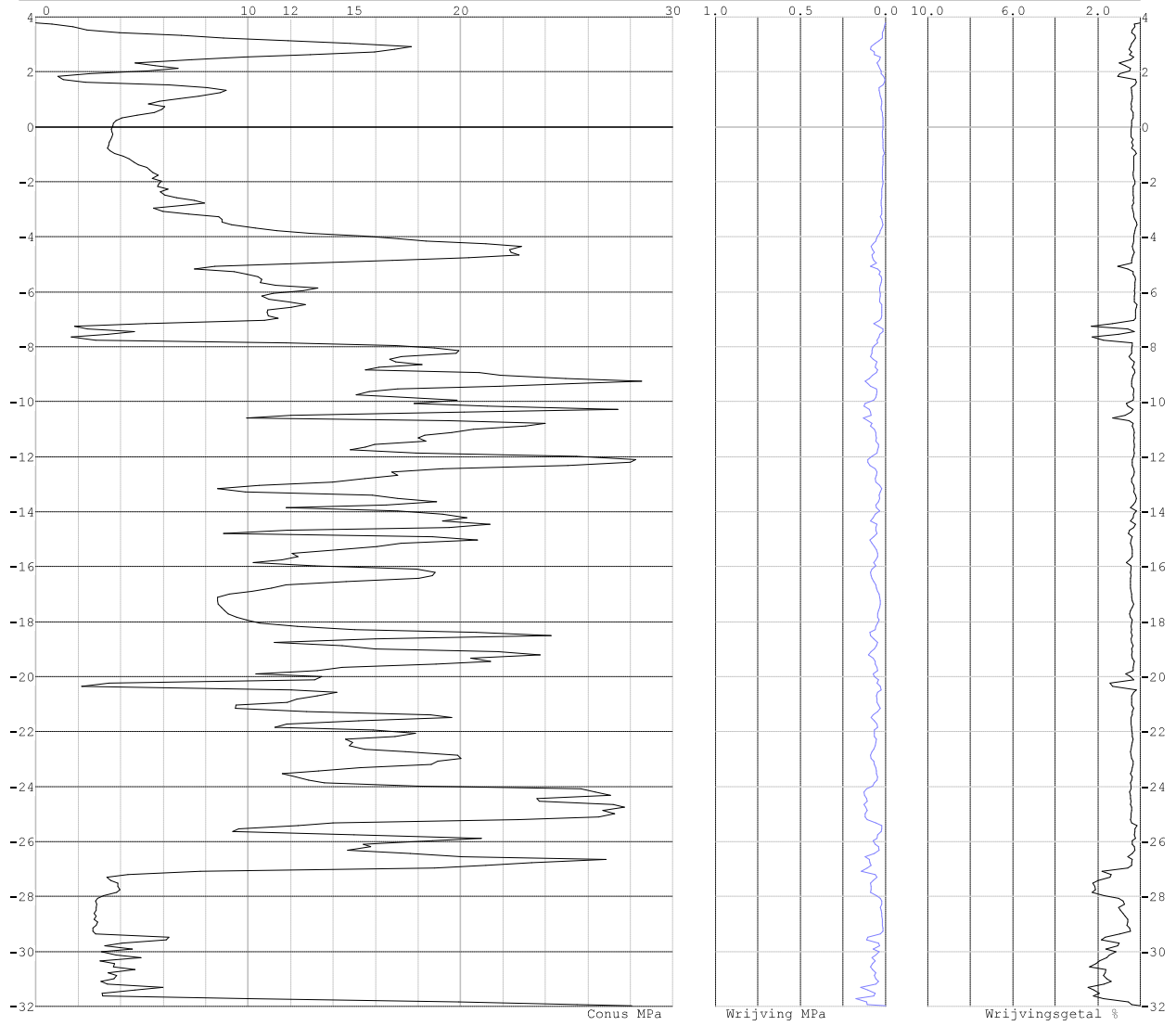

Project : ZWO380 Funderingen
Onderdeel : RLL-TBG380

SONDERINGSGEGEVENS ALGEMEEN: 19-1008_43

Alle niveaus/hoogtes/peilmaten zijn t.o.v.: N.A.P.
Hoogte maaiveld [m] : 9.88 Bodemprofiel: 19-1008_43
Traject negatieve kleeft : 9.88 tot 9.40 [m]
Traject positieve kleeft : 9.20 tot -25.16 [m]

SONDERINGSGEGEVENS GRAFIEK: 19-1008_43

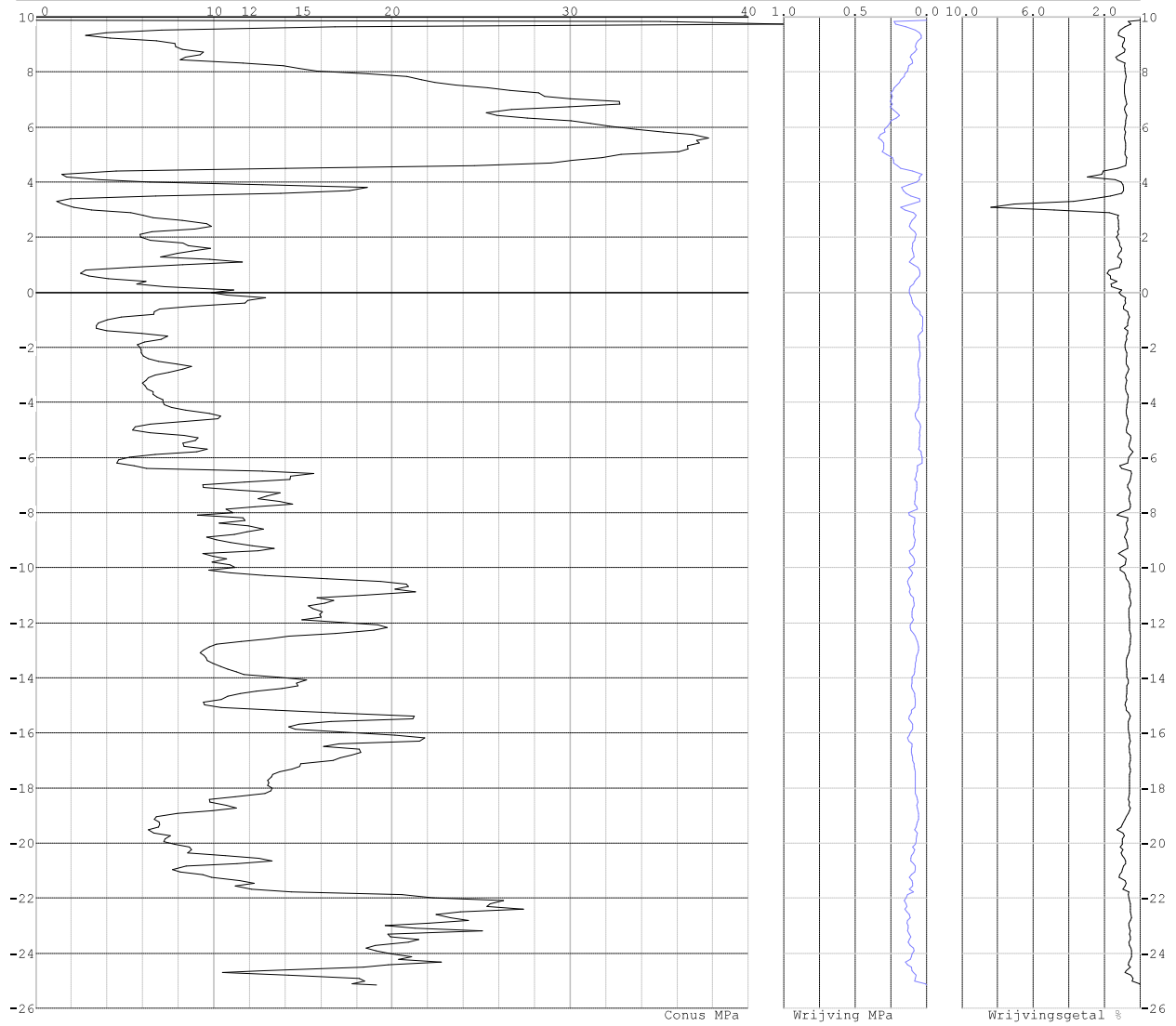

Project : ZWO380 Funderingen
 Onderdeel : RLL-TBG380

SONDERINGSGEGEVENS ALGEMEEN: 328.S02

Alle niveaus/hoogtes/peilmaten zijn t.o.v.: N.A.P.
 Hoogte maaiveld [m] : 10.17 Bodemprofiel: 328.S02
 Traject negatieve kleeft : 10.17 tot 9.90 [m]
 Traject positieve kleeft : 9.80 tot -28.89 [m]

SONDERINGSGEGEVENS GRAFIEK: 328.S02

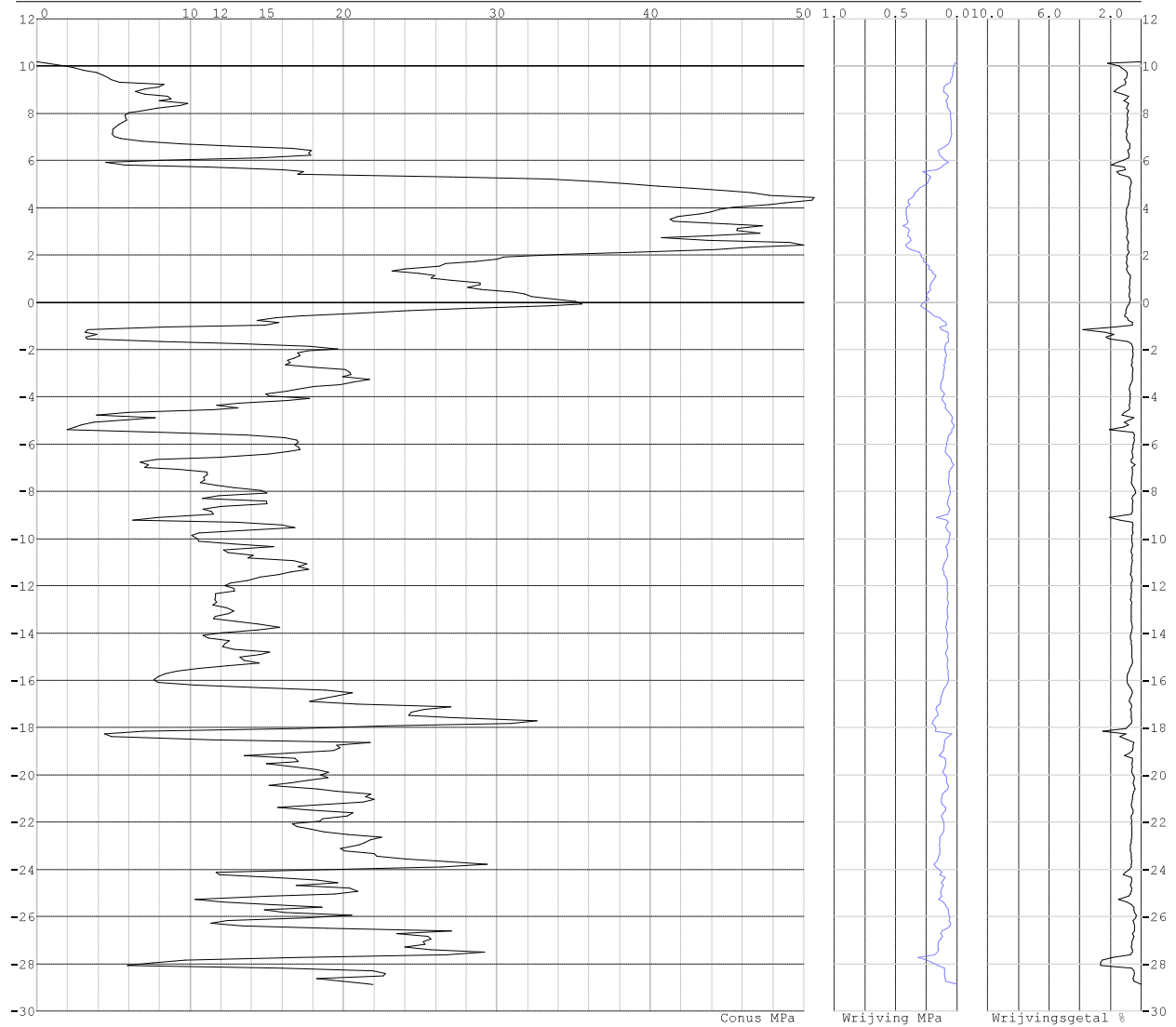

REKENGEVENS SI Ø508/670 druk

Berekening : Ontwerpend
 Rekenmethode : Drukpalen volgens NEN-EN 1997-1, art. 7.6.2
 Sondering(en) : 19-1008_1, 19-1008_6, 166.S01, 19-1008_11, 19-1008_12
 : 19-1008_17, 19-1008_20, 19-1008_21, 251.S01, 19-1008_29
 : 283.S02, 19-1008_35, 312.S03, 19-1008_43, 328.S02

Stijf bouwwerk : NEE
 Paalgroep : NEE
 Aantal sonderingen : 15
 Factor ξ_3 (n=1) : 1.39 (handmatig)
 Factor ξ_3 (gem) : 1.39 (handmatig)
 Factor ξ_4 (min) : 1.39 (handmatig)
 Weerstandsfactor γ_R : 1.20
 $\gamma_{f,ink}$: 1.0
 $R_{f,calc,max,ii}$ begrenzen op $0.75 * R_{b,calc,max,ii}$: NEE
 UGT draagvermogen zonder negatieve kleeft : NEE

Paal : SI Ø508/670
 Niveau paalkop [m] : N.A.P. 0.00
 Bovenbel. [kN/m²] : 0.00

Project : ZWO380 Funderingen
Onderdeel : RLL-TBG380

PAALPUNTNIVEAUS SI Ø508/670

Alle niveaus/hoogtes/peilmaten zijn t.o.v. : N.A.P.

Nr	Beginniveau [m]	Eindniveau [m]	Stapgrootte [m]
1	-6.00	-30.00	0.50

RESULTATEN SI Ø508/670 druk (n=1)

Alle niveaus/hoogtes/peilmaten zijn t.o.v. : N.A.P.

Sondering	19-1008_1	19-1008_6	166.S01	19-1008_11	19-1008_12	19-1008_17
Niveau [m]	F _{netto;d} [kN]	F _{netto;d} [kN]	F _{netto;d} [kN]	F _{netto;d} [kN]	F _{netto;d} [kN]	F _{netto;d} [kN]
-6.00	-71	2215	1436	-53	1758	-41
-6.50	-70	2342	1620	-47	1420	0
-7.00	-66	2413	1721	32	1377	-50
-7.50	-25	2768	1830	137	1337	-88
-8.00	-12	2996	1954	172	1291	-77
-8.50	-17	3209	2075	202	1284	-51
-9.00	85	3321	2181	235	1263	-47
-9.50	120	3387	2442	269	1281	222
-10.00	152	3811	2245	269	1295	89
-10.50	199	3886	2235	296	1311	336
-11.00	304	3961	2170	329	1301	995
-11.50	358	4027	2172	346	1342	1158
-12.00	398	4091	2179	321	1355	1297
-12.50	707	4121	2225	722	1361	1201
-13.00	789	4150	2337	1011	1382	1268
-13.50	871	4336	2644	1018	1440	1346
-14.00	1056	4411	2755	1108	1474	1431
-14.50	1220	4486	2865	1190	1501	1605
-15.00	1320	4561	2968	1265	1525	1802
-15.50	1308	4396	3249	1345	1575	1911
-16.00	1481	3707	3390	1511	1628	1449
-16.50	1594	3765	3510	1592	1667	1406
-17.00	1802	3773	3596	1669	1712	1494
-17.50	2613	3781	3654	1931	1748	1469
-18.00	2309	3906	3758	2299	1954	1465
-18.50	2364	4606	3843	2424	2032	1705
-19.00	2078	4615	3900	2519	2290	1865
-19.50	2081	4717	3939	2585	2424	1881
-20.00	2080	4827	4108	2819	2650	1972
-20.50	2185	4927	0	2749	2652	2102
-21.00	2207	5058	0	2432	2934	2081
-21.50	3012	5497	0	2452	3061	2286
-22.00	3906	0	0	2388	3190	2531
-22.50	3981	0	0	2400	3275	2473
-23.00	4056	0	0	2393	3489	2477
-23.50	4131	0	0	2580	3418	2504
-24.00	4206	0	0	2660	3156	2542
-24.50	4281	0	0	2706	3119	2593
-25.00	4356	0	0	2746	3103	2653
-25.50	4431	0	0	3414	3053	2714
-26.00	4506	0	0	3368	3118	2785
-26.50	4581	0	0	3440	3177	2921
-27.00	4656	0	0	3535	3228	2385
-27.50	4731	0	0	3655	3268	2409
-28.00	4806	0	0	3854	3621	2449
-28.50	4881	0	0	4066	4017	2452
-29.00	4956	0	0	4217	4128	2402
-29.50	5031	0	0	4772	0	2722
-30.00	5106	0	0	4933	0	3140

Project : ZWO380 Funderingen
 Onderdeel : RLL-TBG380

RESULTATEN SI Ø508/670 druk (n=1)

Alle niveaus/hoogtes/peilmaten zijn t.o.v.: N.A.P.

Niveau	19-1008_20	19-1008_21	251.S01	19-1008_29	283.S02	19-1008_35
[m]	F _{netto;d} [kN]	F _{netto;d} [kN]	F _{netto;d} [kN]	F _{netto;d} [kN]	F _{netto;d} [kN]	F _{netto;d} [kN]
-6.00	327	670	642	1248	1011	931
-6.50	476	602	547	1473	1081	952
-7.00	501	617	577	1492	1113	979
-7.50	557	672	575	1548	1179	1054
-8.00	456	721	579	1620	1253	1085
-8.50	474	733	563	1685	1299	1108
-9.00	502	756	809	1648	1335	1143
-9.50	518	870	942	1220	1202	1203
-10.00	496	900	1000	1260	1242	1239
-10.50	615	946	1050	1293	1276	1316
-11.00	612	976	1083	1308	1309	1350
-11.50	598	1016	1142	1275	1307	1374
-12.00	624	1043	1336	1435	1550	1400
-12.50	652	1086	1424	1445	1689	1504
-13.00	665	1120	1301	1435	1830	1640
-13.50	730	1168	1365	1463	1978	1731
-14.00	762	1197	1407	1491	2071	1920
-14.50	773	1186	1413	1515	2127	1987
-15.00	805	1178	1374	1542	2166	1992
-15.50	829	1214	1960	1608	2354	2060
-16.00	855	1233	2182	1622	2507	2117
-16.50	872	1212	1983	1648	2675	2134
-17.00	903	1236	2033	1691	2947	2176
-17.50	1027	1276	2110	2088	3054	2342
-18.00	1076	1358	2132	2389	3055	2384
-18.50	1104	1382	2122	2412	3155	2525
-19.00	1198	1413	2033	2233	3254	2589
-19.50	1309	1427	1991	3058	3337	2680
-20.00	1310	1440	1994	3420	3325	2933
-20.50	1277	1455	1999	2967	3531	3025
-21.00	1298	1477	2045	2855	3781	3125
-21.50	1325	1500	2067	2709	3880	3250
-22.00	1349	1524	2080	2678	3959	3544
-22.50	1368	1545	2117	2608	4042	3490
-23.00	1627	1565	2180	2641	4149	3573
-23.50	1747	1597	2274	2732	4433	3360
-24.00	1863	1625	2324	2758	4215	3412
-24.50	1967	1645	2372	2791	3329	3474
-25.00	2044	1671	2548	2821	3261	3519
-25.50	2123	1694	2860	2868	3180	3449
-26.00	2197	1718	3286	2908	3179	3674
-26.50	2301	1740	3903	2941	3150	3983
-27.00	2224	1761	3517	2977	3188	4119
-27.50	2292	1795	3626	3025	3229	4228
-28.00	2314	1821	3651	3052	3222	4313
-28.50	2361	1845	3329	3088	3243	4546
-29.00	2402	1877	3250	3257	3268	4701
-29.50	2451	1908	3263	3412	3290	3968
-30.00	2509	1934	3179	3371	0	3888

Project : ZWO380 Funderingen
 Onderdeel : RLL-TBG380

RESULTATEN SI Ø508/670 druk (n=1)

Alle niveaus/hoogtes/peilmaten zijn t.o.v.: N.A.P.

Sondering 312.S03 19-1008_43 328.S02

Niveau [m]	F _{netto;d} [kN]	F _{netto;d} [kN]	F _{netto;d} [kN]
-6.00	843	934	1386
-6.50	861	1260	1350
-7.00	855	1332	1479
-7.50	1011	1405	1563
-8.00	1675	1485	1642
-8.50	1686	1564	1698
-9.00	1820	1645	1825
-9.50	1890	1716	1998
-10.00	2033	1899	2160
-10.50	2245	2053	2271
-11.00	2175	2071	2355
-11.50	2287	2127	2428
-12.00	2399	2187	2492
-12.50	2394	2201	2580
-13.00	2430	2236	2673
-13.50	2597	2355	2539
-14.00	2667	2416	2564
-14.50	2691	2429	2621
-15.00	2686	2732	2658
-15.50	2733	2813	2663
-16.00	2769	2793	2765
-16.50	2774	2774	2877
-17.00	2793	2589	2977
-17.50	2865	2594	3018
-18.00	2564	2641	2773
-18.50	2622	2671	3306
-19.00	2681	2695	3396
-19.50	2653	2763	3581
-20.00	2623	2894	3715
-20.50	2967	2994	3919
-21.00	3149	3107	4051
-21.50	3269	3414	4194
-22.00	3455	3855	4138
-22.50	3574	3661	4265
-23.00	3668	0	4215
-23.50	3756	0	4295
-24.00	3955	0	4306
-24.50	4047	0	4382
-25.00	3583	0	4372
-25.50	3572	0	4495
-26.00	3530	0	4292
-26.50	3525	0	4402
-27.00	3486	0	0
-27.50	3512	0	0
-28.00	3537	0	0
-28.50	3560	0	0
-29.00	3587	0	0
-29.50	3651	0	0
-30.00	0	0	0

Project : ZWO380 Funderingen
 Onderdeel : RLL-TBG380

SAMENVATTINGSTABEL SI Ø508/670 druk (n=1)

Uitgangspunten

- paal : SI Ø508/670
 - paaltype : In de grond gevormde geschroefde paal; groutinjectie
 - schachtafmeting : 590 mm
 Paalklassefactor α_p : 0.63
 Factor α_c (tabel 7.c EC 7.1) : 0.009 (zandlagen; voor kleilagen zie tabel 7.d)
 Correlatiefactor $\xi_{s(n=1)}$: 1.39

Alle niveaus/hoogtes/peilmaten zijn t.o.v.: N.A.P.

sondering	maaiveld niveau	paalpunt niveau	Beziijkdraagvermogen			Rekenwaarden		
			$R_{b,real}$ [kN]	$R_{s,real}$ [kN]	$R_{c,real}$ [kN]	$R_{c;d}$ [kN]	$F_{nk;d}$ [kN]	$R_{c,netto;d}$ [kN]
19-1008_1	2.12	-6.00	74.1	0.0	74.1	44.5	-115.4	-70.9
		-6.50	75.9	0.0	75.9	45.5	-115.4	-69.9
		-7.00	83.0	0.0	83.0	49.8	-115.4	-65.6
		-7.50	148.9	2.4	151.2	90.7	-115.4	-24.7
		-8.00	142.3	30.1	172.3	103.3	-115.4	-12.0
		-8.50	103.4	61.3	164.7	98.8	-115.4	-16.6
		-9.00	263.4	70.8	334.1	200.3	-115.4	85.0
		-9.50	270.2	122.6	392.8	235.5	-115.4	120.1
		-10.00	277.8	168.6	446.4	267.7	-115.4	152.3
		-10.50	301.0	222.6	523.6	313.9	-115.4	198.5
		-11.00	440.3	259.3	699.5	419.4	-115.4	304.0
		-11.50	467.1	322.9	790.0	473.6	-115.4	358.3
		-12.00	451.3	404.9	856.2	513.3	-115.4	398.0
		-12.50	911.7	459.3	1371.0	821.9	-115.4	706.5
		-13.00	962.1	547.0	1509.0	904.7	-115.4	789.3
		-13.50	1010.3	634.6	1644.9	986.1	-115.4	870.8
		-14.00	1243.4	710.1	1953.4	1171.1	-115.4	1055.8
		-14.50	1417.3	809.6	2226.8	1335.0	-115.4	1219.7
		-15.00	1494.3	900.2	2394.5	1435.5	-115.4	1320.2
		-15.50	1374.5	999.5	2374.0	1423.3	-115.4	1307.9
		-16.00	1578.4	1084.5	2663.0	1596.5	-115.4	1481.1
		-16.50	1672.8	1178.2	2851.0	1709.2	-115.4	1593.9
		-17.00	1925.2	1273.5	3198.7	1917.7	-115.4	1802.3
		-17.50	3165.4	1384.9	4550.4	2728.0	-115.4	2612.7
		-18.00	2533.5	1510.0	4043.5	2424.2	-115.4	2308.8
		-18.50	2500.1	1635.1	4135.2	2479.2	-115.4	2363.8
		-19.00	1897.8	1760.3	3658.1	2193.1	-115.4	2077.7
		-19.50	1777.5	1885.4	3662.9	2196.0	-115.4	2080.6
		-20.00	1622.6	2039.8	3662.4	2195.7	-115.4	2080.3
		-20.50	1637.4	2200.1	3837.5	2300.6	-115.4	2185.3
		-21.00	1506.1	2366.9	3873.0	2321.9	-115.4	2206.6
-21.50	2734.1	2481.7	5215.9	3127.0	-115.4	3011.7		
-22.00	4101.0	2606.9	6707.8	4021.5	-115.4	3906.1		
-22.50	4101.0	2732.0	6832.9	4096.5	-115.4	3981.1		
-23.00	4101.0	2857.1	6958.0	4171.5	-115.4	4056.1		
-23.50	4101.0	2982.2	7083.2	4246.5	-115.4	4131.1		
-24.00	4101.0	3107.3	7208.3	4321.5	-115.4	4206.1		
-24.50	4101.0	3232.4	7333.4	4396.5	-115.4	4281.2		
-25.00	4101.0	3357.5	7458.5	4471.5	-115.4	4356.2		
-25.50	4101.0	3482.7	7583.6	4546.5	-115.4	4431.2		
-26.00	4101.0	3607.8	7708.7	4621.5	-115.4	4506.2		
-26.50	4101.0	3732.9	7833.8	4696.5	-115.4	4581.2		
-27.00	4101.0	3858.0	7959.0	4771.6	-115.4	4656.2		
-27.50	4101.0	3983.1	8084.1	4846.6	-115.4	4731.2		
-28.00	4101.0	4108.2	8209.2	4921.6	-115.4	4806.2		
-28.50	4101.0	4233.3	8334.3	4996.6	-115.4	4881.2		
-29.00	4101.0	4358.5	8459.4	5071.6	-115.4	4956.2		
-29.50	4101.0	4483.6	8584.5	5146.6	-115.4	5031.2		
-30.00	4101.0	4608.7	8709.6	5221.6	-115.4	5106.2		
19-1008_6	11.00	-6.00	2439.0	1255.0	3694.0	2214.6	0.0	2214.6
		-6.50	2526.9	1380.1	3907.0	2342.3	0.0	2342.3
		-7.00	2518.9	1505.2	4024.1	2412.6	0.0	2412.6
		-7.50	2986.5	1630.3	4616.8	2767.9	0.0	2767.9
		-8.00	3241.8	1755.4	4997.3	2996.0	0.0	2996.0
		-8.50	3472.2	1880.6	5352.8	3209.1	0.0	3209.1
		-9.00	3533.5	2005.7	5539.2	3320.9	0.0	3320.9
		-9.50	3518.5	2130.8	5649.3	3386.9	0.0	3386.9
		-10.00	4101.0	2255.9	6356.9	3811.1	0.0	3811.1
		-10.50	4101.0	2381.0	6482.0	3886.1	0.0	3886.1
		-11.00	4101.0	2506.1	6607.1	3961.1	0.0	3961.1
		-11.50	4085.8	2631.2	6717.0	4027.0	0.0	4027.0
		-12.00	4067.7	2756.4	6824.0	4091.1	0.0	4091.1
		-12.50	3992.6	2881.5	6874.1	4121.2	0.0	4121.2
		-13.00	3914.8	3006.6	6921.4	4149.5	0.0	4149.5
		-13.50	4101.0	3131.7	7232.7	4336.1	0.0	4336.1
		-14.00	4101.0	3256.8	7357.8	4411.1	0.0	4411.1
		-14.50	4101.0	3381.9	7482.9	4486.1	0.0	4486.1
		-15.00	4101.0	3507.0	7608.0	4561.1	0.0	4561.1
		-15.50	3699.8	3632.2	7331.9	4395.6	0.0	4395.6
		-16.00	2425.7	3757.3	6183.0	3706.8	0.0	3706.8
-16.50	2397.0	3882.4	6279.4	3764.6	0.0	3764.6		
-17.00	2285.4	4007.5	6292.9	3772.7	0.0	3772.7		
-17.50	2174.9	4132.6	6307.5	3781.5	0.0	3781.5		
-18.00	2256.8	4257.7	6514.5	3905.6	0.0	3905.6		
-18.50	3308.9	4374.5	7683.3	4606.3	0.0	4606.3		
-19.00	3198.2	4499.6	7697.8	4615.0	0.0	4615.0		
-19.50	3243.5	4624.7	7868.2	4717.2	0.0	4717.2		
-20.00	3301.1	4749.8	8050.9	4826.7	0.0	4826.7		
-20.50	3342.6	4874.9	8217.5	4926.6	0.0	4926.6		
-21.00	3436.2	5000.0	8436.3	5057.7	0.0	5057.7		
-21.50	4044.3	5125.1	9169.5	5497.3	0.0	5497.3		
166.S01	3.45	-6.00	1838.5	571.4	2410.0	1444.8	-8.9	1435.9
		-6.50	2019.9	696.6	2716.4	1628.5	-8.9	1619.7
		-7.00	2063.9	821.7	2885.6	1730.0	-8.9	1721.1

Project : ZWO380 Funderingen
 Onderdeel : RLL-TBG380

Alle niveaus/hoogtes/peilmaten zijn t.o.v.: N.A.P.

sondering	maaiveld niveau	paalpunt niveau	Bezwijkdraagvermogen			Rekenwaarden		
			R _{b,real} [kN]	R _{r,real} [kN]	R _{c,real} [kN]	R _{b;d} [kN]	F _{bk;d} [kN]	R _{c,netto;d} [kN]
166.S01	3.45	-7.50	2120.6	946.8	3067.4	1839.0	-8.9	1830.1
		-8.00	2202.7	1071.9	3274.6	1963.2	-8.9	1954.3
		-8.50	2280.3	1196.1	3476.4	2084.1	-8.9	2075.3
		-9.00	2333.3	1320.1	3653.3	2190.2	-8.9	2181.4
		-9.50	2646.1	1442.3	4088.4	2451.1	-8.9	2442.2
		-10.00	2191.9	1567.4	3759.4	2253.8	-8.9	2244.9
		-10.50	2050.8	1692.5	3743.3	2244.2	-8.9	2235.3
		-11.00	1817.1	1817.6	3634.8	2179.1	-8.9	2170.2
		-11.50	1694.2	1942.8	3636.9	2180.4	-8.9	2171.5
		-12.00	1591.2	2057.7	3648.9	2187.6	-8.9	2178.7
		-12.50	1571.1	2154.9	3726.0	2233.8	-8.9	2224.9
		-13.00	1666.9	2245.8	3912.7	2345.7	-8.9	2336.9
		-13.50	2087.6	2338.1	4425.7	2653.3	-8.9	2644.4
		-14.00	2163.8	2445.5	4609.3	2763.4	-8.9	2754.5
		-14.50	2224.6	2569.3	4794.0	2874.1	-8.9	2865.2
		-15.00	2271.1	2694.4	4965.5	2976.9	-8.9	2968.1
		-15.50	2614.1	2819.5	5433.6	3257.6	-8.9	3248.7
		-16.00	2725.3	2944.7	5670.0	3399.3	-8.9	3390.4
		-16.50	2800.2	3069.8	5870.0	3519.2	-8.9	3510.3
		-17.00	2818.7	3194.9	6013.6	3605.3	-8.9	3596.4
-17.50	2789.5	3320.0	6109.5	3662.8	-8.9	3653.9		
-18.00	2838.7	3445.1	6283.9	3767.3	-8.9	3758.4		
-18.50	2854.2	3570.2	6424.4	3851.6	-8.9	3842.7		
-19.00	2824.6	3695.3	6519.9	3908.8	-8.9	3899.9		
-19.50	2764.1	3820.5	6584.6	3947.6	-8.9	3938.7		
-20.00	2920.5	3945.6	6866.1	4116.4	-8.9	4107.5		
19-1008_11	0.62	-6.00	136.3	0.0	136.3	81.7	-135.0	-53.3
		-6.50	146.6	0.0	146.6	87.9	-135.0	-47.1
		-7.00	273.2	5.5	278.7	167.1	-135.0	32.0
		-7.50	413.9	39.6	453.5	271.9	-135.0	136.9
		-8.00	421.6	89.8	511.4	306.6	-135.0	171.6
		-8.50	426.6	135.6	562.2	337.0	-135.0	202.0
		-9.00	445.6	171.0	616.7	369.7	-135.0	234.7
		-9.50	469.4	204.8	674.2	404.2	-135.0	269.1
		-10.00	434.6	239.8	674.4	404.3	-135.0	269.3
		-10.50	436.3	281.8	718.1	430.5	-135.0	295.5
		-11.00	442.9	330.8	773.7	463.9	-135.0	328.8
		-11.50	413.4	389.8	803.1	481.5	-135.0	346.4
		-12.00	296.8	464.1	760.9	456.2	-135.0	321.1
		-12.50	937.8	491.9	1429.7	857.1	-135.0	722.1
		-13.00	1332.2	579.6	1911.8	1146.2	-135.0	1011.1
		-13.50	1240.8	683.1	1923.9	1153.4	-135.0	1018.4
		-14.00	1284.1	788.6	2072.7	1242.6	-135.0	1107.6
		-14.50	1314.6	895.2	2209.8	1324.8	-135.0	1189.8
		-15.00	1333.3	1001.8	2335.1	1400.0	-135.0	1264.9
		-15.50	1367.1	1101.6	2468.7	1480.1	-135.0	1345.0
-16.00	1559.2	1185.9	2745.0	1645.7	-135.0	1510.7		
-16.50	1596.3	1284.4	2880.7	1727.0	-135.0	1592.0		
-17.00	1629.7	1379.2	3008.9	1803.9	-135.0	1668.9		
-17.50	1977.8	1468.7	3446.5	2066.2	-135.0	1931.2		
-18.00	2477.9	1581.5	4059.4	2433.7	-135.0	2298.7		
-18.50	2562.5	1706.6	4269.1	2559.4	-135.0	2424.4		
-19.00	2596.0	1831.7	4427.7	2654.5	-135.0	2519.4		
-19.50	2580.8	1956.8	4537.6	2720.4	-135.0	2585.4		
-20.00	2846.1	2081.9	4928.0	2954.4	-135.0	2819.4		
-20.50	2603.4	2207.0	4810.4	2884.0	-135.0	2748.9		
-21.00	1949.5	2332.2	4281.6	2566.9	-135.0	2431.9		
-21.50	1865.2	2450.1	4315.3	2587.1	-135.0	2452.0		
-22.00	1633.6	2575.2	4208.8	2523.3	-135.0	2388.2		
-22.50	1528.9	2700.3	4229.2	2535.5	-135.0	2400.4		
-23.00	1403.5	2813.7	4217.2	2528.3	-135.0	2393.2		
-23.50	1638.9	2889.1	4528.0	2714.6	-135.0	2579.6		
-24.00	1676.1	2986.2	4662.3	2795.2	-135.0	2660.1		
-24.50	1642.1	3096.4	4738.5	2840.8	-135.0	2705.8		
-25.00	1604.9	3201.2	4806.0	2881.3	-135.0	2746.3		
-25.50	2630.1	3289.6	5919.7	3549.0	-135.0	3413.9		
-26.00	2428.7	3414.7	5843.4	3503.3	-135.0	3368.2		
-26.50	2422.6	3539.8	5962.4	3574.6	-135.0	3439.6		
-27.00	2456.2	3664.9	6121.1	3669.7	-135.0	3534.7		
-27.50	2531.2	3790.0	6321.3	3789.7	-135.0	3654.7		
-28.00	2738.8	3915.2	6654.0	3989.2	-135.0	3854.2		
-28.50	2967.6	4040.2	7007.8	4201.3	-135.0	4066.3		
-29.00	3093.1	4165.3	7258.4	4351.6	-135.0	4216.5		
-29.50	3894.2	4290.5	8184.6	4906.8	-135.0	4771.8		
-30.00	4037.8	4415.6	8453.4	5068.0	-135.0	4933.0		
19-1008_12	3.57	-6.00	1574.5	1357.6	2932.1	1757.8	0.0	1757.8
		-6.50	912.3	1456.0	2368.3	1419.8	0.0	1419.8
		-7.00	718.5	1578.0	2296.5	1376.8	0.0	1376.8
		-7.50	526.5	1703.1	2229.6	1336.7	0.0	1336.7
		-8.00	326.8	1827.0	2153.9	1291.3	0.0	1291.3
		-8.50	250.5	1890.8	2141.2	1283.7	0.0	1283.7
		-9.00	197.1	1909.4	2106.5	1262.9	0.0	1262.9
		-9.50	213.2	1923.0	2136.2	1280.7	0.0	1280.7
		-10.00	209.1	1950.1	2159.2	1294.5	0.0	1294.5
		-10.50	180.8	2005.2	2186.0	1310.5	0.0	1310.5
		-11.00	122.7	2047.7	2170.3	1301.2	0.0	1301.2
		-11.50	181.9	2056.0	2237.8	1341.6	0.0	1341.6
		-12.00	163.7	2095.7	2259.4	1354.6	0.0	1354.6
		-12.50	160.4	2110.1	2270.6	1361.3	0.0	1361.3
		-13.00	183.3	2121.4	2304.7	1381.7	0.0	1381.7
-13.50	266.3	2135.4	2401.6	1439.8	0.0	1439.8		
-14.00	288.4	2169.8	2458.2	1473.7	0.0	1473.7		
-14.50	288.5	2214.7	2503.2	1500.7	0.0	1500.7		
-15.00	298.3	2246.2	2544.5	1525.5	0.0	1525.5		

Project : ZWO380 Funderingen
Onderdeel : RLL-TBG380

Alle niveaus/hoogtes/peilmaten zijn t.o.v.: N.A.P.

Table with columns: sondering, maaiveld niveau, paalpunt niveau, Bezwijkdraagvermogen (R_b, R_s, R_c), Rekenwaarden (R_d, F_k, R_netto). Rows include sondering 19-1008_12, 19-1008_17, and 19-1008_20 with associated data points.

Project : ZWO380 Funderingen
 Onderdeel : RLL-TBG380

Alle niveaus/hoogtes/peilmaten zijn t.o.v.: N.A.P.

sondering	maaiveld niveau	paalpunt niveau	Bezwijkdraagvermogen			Rekenwaarden		
			R _{b,real} [kN]	R _{s,real} [kN]	R _{c,real} [kN]	R _d [kN]	F _{nk;d} [kN]	R _{d,netto;d} [kN]
19-1008_20	-0.03	-14.50	355.8	992.1	1347.9	808.1	-35.5	772.5
		-15.00	336.3	1065.9	1402.2	840.6	-35.5	805.1
		-15.50	334.7	1107.3	1442.1	864.5	-35.5	829.0
		-16.00	346.3	1138.4	1484.7	890.1	-35.5	854.6
		-16.50	331.0	1182.5	1513.6	907.4	-35.5	871.9
		-17.00	354.0	1211.0	1565.1	938.3	-35.5	902.8
		-17.50	526.9	1246.0	1772.9	1062.9	-35.5	1027.4
		-18.00	542.0	1311.6	1853.7	1111.3	-35.5	1075.8
		-18.50	511.6	1388.4	1900.0	1139.1	-35.5	1103.6
		-19.00	611.3	1445.8	2057.1	1233.3	-35.5	1197.7
		-19.50	720.2	1523.2	2243.4	1345.0	-35.5	1309.4
		-20.00	642.1	1603.0	2245.1	1346.0	-35.5	1310.4
		-20.50	483.7	1705.7	2189.4	1312.6	-35.5	1277.1
		-21.00	380.9	1843.3	2224.3	1333.5	-35.5	1297.9
		-21.50	367.4	1901.7	2269.1	1360.3	-35.5	1324.8
		-22.00	369.7	1940.1	2309.8	1384.7	-35.5	1349.2
		-22.50	358.2	1982.1	2340.3	1403.0	-35.5	1367.5
		-23.00	758.0	2015.9	2773.9	1663.0	-35.5	1627.5
		-23.50	891.0	2081.8	2972.8	1782.3	-35.5	1746.7
		-24.00	1010.4	2155.6	3166.1	1898.1	-35.5	1862.6
		-24.50	1106.5	2233.0	3339.5	2002.1	-35.5	1966.5
		-25.00	1140.6	2328.1	3468.8	2079.6	-35.5	2044.1
		-25.50	1186.4	2414.6	3601.1	2158.9	-35.5	2123.4
		-26.00	1224.2	2499.2	3723.4	2232.3	-35.5	2196.7
		-26.50	1321.2	2575.7	3896.9	2336.2	-35.5	2300.7
		-27.00	1100.5	2668.9	3769.4	2259.8	-35.5	2224.3
		-27.50	1132.0	2750.8	3882.8	2327.8	-35.5	2292.3
		-28.00	1094.5	2824.9	3919.4	2349.8	-35.5	2314.2
		-28.50	1085.8	2911.7	3997.6	2396.6	-35.5	2361.1
		-29.00	1074.2	2992.2	4066.4	2437.9	-35.5	2402.4
-29.50	1090.8	3056.9	4147.7	2486.6	-35.5	2451.1		
-30.00	1105.7	3138.6	4244.3	2544.6	-35.5	2509.0		
19-1008_21	1.78	-6.00	1028.7	273.3	1302.1	780.6	-110.9	669.7
		-6.50	835.6	353.4	1189.0	712.8	-110.9	601.9
		-7.00	781.9	433.1	1214.9	728.4	-110.9	617.5
		-7.50	775.3	531.1	1306.4	783.2	-110.9	672.3
		-8.00	765.4	622.9	1388.4	832.3	-110.9	721.4
		-8.50	692.8	715.6	1408.4	844.4	-110.9	733.5
		-9.00	682.9	763.6	1446.5	867.2	-110.9	756.3
		-9.50	836.9	799.7	1636.6	981.2	-110.9	870.3
		-10.00	831.9	854.7	1686.7	1011.2	-110.9	900.3
		-10.50	859.1	903.0	1762.1	1056.4	-110.9	945.5
		-11.00	854.9	958.4	1813.3	1087.1	-110.9	976.2
		-11.50	851.4	1028.3	1879.7	1126.9	-110.9	1016.0
		-12.00	818.0	1106.8	1924.8	1153.9	-110.9	1043.0
		-12.50	829.7	1167.1	1996.8	1197.1	-110.9	1086.2
		-13.00	816.0	1236.8	2052.7	1230.7	-110.9	1119.7
		-13.50	819.6	1313.9	2133.5	1279.1	-110.9	1168.2
		-14.00	752.8	1428.6	2181.4	1307.8	-110.9	1196.9
		-14.50	619.8	1543.5	2163.4	1297.0	-110.9	1186.1
		-15.00	521.5	1627.6	2149.2	1288.5	-110.9	1177.6
		-15.50	521.4	1689.0	2210.3	1325.1	-110.9	1214.2
		-16.00	433.7	1807.5	2241.2	1343.7	-110.9	1232.8
		-16.50	280.8	1925.9	2206.7	1323.0	-110.9	1212.0
		-17.00	300.0	1946.0	2246.1	1346.6	-110.9	1235.7
		-17.50	343.9	1969.5	2313.4	1386.9	-110.9	1276.0
		-18.00	435.6	2014.4	2450.0	1468.8	-110.9	1357.9
		-18.50	346.4	2144.2	2490.6	1493.2	-110.9	1382.2
		-19.00	307.6	2234.8	2542.4	1524.2	-110.9	1413.3
		-19.50	307.1	2257.8	2565.0	1537.8	-110.9	1426.9
		-20.00	311.0	2276.2	2587.2	1551.1	-110.9	1440.2
		-20.50	317.7	2294.3	2612.0	1566.0	-110.9	1455.1
-21.00	335.4	2312.6	2648.0	1587.5	-110.9	1476.6		
-21.50	352.1	2334.7	2686.8	1610.8	-110.9	1499.9		
-22.00	366.2	2360.3	2726.5	1634.6	-110.9	1523.7		
-22.50	369.7	2391.6	2761.3	1655.4	-110.9	1544.5		
-23.00	372.9	2422.6	2795.5	1676.0	-110.9	1565.1		
-23.50	395.6	2452.4	2848.0	1707.4	-110.9	1596.5		
-24.00	407.2	2487.8	2895.0	1735.6	-110.9	1624.7		
-24.50	405.3	2524.1	2929.5	1756.3	-110.9	1645.4		
-25.00	409.4	2562.4	2971.8	1781.6	-110.9	1670.7		
-25.50	407.9	2602.6	3010.4	1804.8	-110.9	1693.9		
-26.00	408.7	2641.0	3049.8	1828.4	-110.9	1717.5		
-26.50	411.0	2675.9	3086.8	1850.6	-110.9	1739.7		
-27.00	411.3	2711.6	3122.9	1872.2	-110.9	1761.3		
-27.50	433.1	2746.6	3179.8	1906.3	-110.9	1795.4		
-28.00	437.8	2784.5	3222.3	1931.8	-110.9	1820.9		
-28.50	439.6	2823.5	3263.2	1956.3	-110.9	1845.4		
-29.00	453.9	2861.4	3315.3	1987.6	-110.9	1876.7		
-29.50	465.7	2901.2	3367.0	2018.6	-110.9	1907.7		
-30.00	467.8	2943.8	3411.6	2045.3	-110.9	1934.4		
251.S01	-1.05	-6.00	673.9	417.3	1091.2	654.2	-12.2	642.0
		-6.50	430.4	503.1	933.5	559.6	-12.2	547.5
		-7.00	379.8	603.2	983.0	589.3	-12.2	577.1
		-7.50	278.9	700.0	978.9	586.8	-12.2	574.7
		-8.00	196.5	788.9	985.4	590.8	-12.2	578.6
		-8.50	110.3	848.8	959.1	575.0	-12.2	562.8
		-9.00	512.4	857.8	1370.2	821.5	-12.2	809.3
		-9.50	679.2	913.1	1592.3	954.6	-12.2	942.5
		-10.00	691.9	997.0	1688.9	1012.5	-12.2	1000.3
		-10.50	676.5	1095.6	1772.1	1062.4	-12.2	1050.2
		-11.00	657.0	1170.4	1827.4	1095.6	-12.2	1083.4
		-11.50	709.0	1215.9	1924.9	1154.0	-12.2	1141.9
-12.00	988.0	1261.1	2249.1	1348.4	-12.2	1336.2		

Project : ZWO380 Funderingen
Onderdeel : RLL-TBG380

Alle niveaus/hoogtes/peilmaten zijn t.o.v.: N.A.P.

Table with columns: sondering, maaiveld niveau, paalpunt niveau, Bezwijkdraagvermogen (R_b, R_s, R_c), Rekenwaarden (R_s,d, F_bk,d, R_o, netto,d). Contains data for sondering 251-S01, 19-1008_29, and 283-S02.

Project : ZWO380 Funderingen
Onderdeel : RLL-TBG380

Alle niveaus/hoogtes/peilmaten zijn t.o.v.: N.A.P.

sondering	maaiveld niveau	paalpunt niveau	Bezwijkdraagvermogen			Rekenwaarden		
			$R_{b,real}$ [kN]	$R_{s,real}$ [kN]	$R_{c,real}$ [kN]	$R_{b;d}$ [kN]	$F_{nk;d}$ [kN]	$R_{c,netto;d}$ [kN]
328.S02	10.17	-15.00	1446.8	2987.5	4434.3	2658.5	0.0	2658.5
		-15.50	1354.8	3087.4	4442.3	2663.2	0.0	2663.2
		-16.00	1425.7	3186.6	4612.3	2765.1	0.0	2765.1
		-16.50	1507.8	3290.3	4798.1	2876.6	0.0	2876.6
		-17.00	1550.0	3415.5	4965.4	2976.9	0.0	2976.9
		-17.50	1493.0	3540.6	5033.6	3017.7	0.0	3017.7
		-18.00	941.5	3684.2	4625.7	2773.2	0.0	2773.2
		-18.50	1740.9	3773.2	5514.1	3305.8	0.0	3305.8
		-19.00	1778.9	3885.2	5664.2	3395.8	0.0	3395.8
		-19.50	1968.5	4004.7	5973.2	3581.1	0.0	3581.1
		-20.00	2067.5	4129.8	6197.3	3715.4	0.0	3715.4
		-20.50	2282.0	4254.9	6536.9	3919.0	0.0	3919.0
		-21.00	2376.8	4380.0	6756.8	4050.9	0.0	4050.9
		-21.50	2490.7	4505.1	6995.9	4194.2	0.0	4194.2
		-22.00	2271.8	4630.3	6902.0	4137.9	0.0	4137.9
		-22.50	2358.9	4755.4	7114.3	4265.2	0.0	4265.2
		-23.00	2150.6	4880.5	7031.1	4215.3	0.0	4215.3
		-23.50	2159.3	5005.6	7164.9	4295.5	0.0	4295.5
		-24.00	2052.2	5130.7	7182.9	4306.3	0.0	4306.3
		-24.50	2073.8	5235.0	7308.8	4381.8	0.0	4381.8
		-25.00	1957.7	5335.1	7292.8	4372.2	0.0	4372.2
-25.50	2064.4	5433.2	7497.6	4494.9	0.0	4494.9		
-26.00	1625.6	5533.3	7158.9	4291.9	0.0	4291.9		
-26.50	1703.8	5638.9	7342.7	4402.1	0.0	4402.1		

REKENGEGEVENS SI Ø610/850 druk

Berekening : Ontwerpend
Rekenmethode : Drukpalen volgens NEN-EN 1997-1, art. 7.6.2
Sondering(en) : 19-1008_1, 19-1008_6, 166.S01, 19-1008_11, 19-1008_12
: 19-1008_17, 19-1008_20, 19-1008_21, 251.S01, 19-1008_29
: 283.S02, 19-1008_35, 312.S03, 19-1008_43, 328.S02

Stijf bouwwerk : NEE
Paalgroep : NEE
Aantal sonderingen : 15
Factor $\xi_{3(n-1)}$: 1.39 (handmatig)
Factor $\xi_{3(gem)}$: 1.39 (handmatig)
Factor $\xi_{4(min)}$: 1.39 (handmatig)
Weerstandsfactor γ_R : 1.20
 $\gamma_{F;nk}$: 1.0
 $R_{b,real,max;i}$ begrenzen op $0.75 * R_{b,real,max;i}$: NEE
UGT draagvermogen zonder negatieve kleef : NEE

Paal : SI Ø610/850
Niveau paalkop [m] : N.A.P. 0.00
Bovenbel. [kN/m²] : 0.00

PAALPUNTNIVEAUS SI Ø610/850

Alle niveaus/hoogtes/peilmaten zijn t.o.v. : N.A.P.

Nr	Beginniveau [m]	Eindniveau [m]	Stapgrootte [m]
1	-7.00	-30.00	0.50

Project : ZWO380 Funderingen
 Onderdeel : RLL-TBG380

RESULTATEN SI Ø610/850 druk (n=1)

Alle niveaus/hoogtes/peilmaten zijn t.o.v.: N.A.P.

Sondering	19-1008_1	19-1008_6	166.S01	19-1008_11	19-1008_12	19-1008_17
Niveau [m]	F _{nettoord} [kN]	F _{nettoord} [kN]	F _{nettoord} [kN]	F _{nettoord} [kN]	F _{nettoord} [kN]	F _{nettoord} [kN]
-7.00	-67	3372	2403	106	1755	-34
-7.50	-8	3882	2529	240	1722	-87
-8.00	8	4221	2678	279	1628	-59
-8.50	17	4466	2837	314	1577	-31
-9.00	149	4590	2887	354	1597	-10
-9.50	190	4714	2991	356	1622	387
-10.00	232	5436	2873	401	1624	207
-10.50	311	5511	2925	433	1652	693
-11.00	444	5502	3017	475	1642	1534
-11.50	511	5629	2985	492	1692	1699
-12.00	553	5716	2976	455	1704	1612
-12.50	1013	5752	3029	1101	1714	1756
-13.00	1116	5798	3253	1342	1751	1810
-13.50	1259	6087	3635	1453	1833	1894
-14.00	1478	6180	3778	1561	1869	1990
-14.50	1731	6272	3915	1658	1900	2296
-15.00	1836	6035	4057	1742	1930	2502
-15.50	1790	5033	4455	1835	2022	1857
-16.00	2041	5019	4621	2063	2071	1866
-16.50	2198	5080	4714	2158	2120	1951
-17.00	2641	5070	4780	2251	2183	2064
-17.50	3099	5062	4919	2771	2292	2003
-18.00	3189	5498	5056	3232	2529	1954
-18.50	2898	6133	5186	3433	2621	2358
-19.00	2917	6248	5284	3547	3006	2449
-19.50	2887	6366	5347	3616	3224	2552
-20.00	2860	6495	0	3761	3505	2672
-20.50	2992	6609	0	3283	3478	2851
-21.00	3114	6890	0	3352	3892	2798
-21.50	4304	0	0	3371	4038	3154
-22.00	5555	0	0	3242	4197	3186
-22.50	5648	0	0	3239	4290	3246
-23.00	5740	0	0	3221	4320	3257
-23.50	5833	0	0	3495	4047	3275
-24.00	5926	0	0	3581	4053	3357
-24.50	6019	0	0	3628	3991	3414
-25.00	6112	0	0	3691	3890	3488
-25.50	6204	0	0	4470	3914	3562
-26.00	6297	0	0	4567	3993	3663
-26.50	6390	0	0	4643	4066	2996
-27.00	6483	0	0	4755	4128	3021
-27.50	6576	0	0	4906	4163	3079
-28.00	6668	0	0	5270	4810	3123
-28.50	6761	0	0	5485	5278	3111
-29.00	6854	0	0	5847	0	3015
-29.50	6947	0	0	6505	0	3656
-30.00	0	0	0	6706	0	4113

Project : ZWO380 Funderingen
 Onderdeel : RLL-TBG380

RESULTATEN SI Ø610/850 druk (n=1)

Alle niveaus/hoogtes/peilmaten zijn t.o.v.: N.A.P.

Niveau [m]	19-1008_20		19-1008_21		251.S01		19-1008_29		283.S02		19-1008_35	
	F _{netto;d} [kN]	F _{netto;d} [kN]	F _{netto;d} [kN]	F _{netto;d} [kN]	F _{netto;d} [kN]	F _{netto;d} [kN]	F _{netto;d} [kN]	F _{netto;d} [kN]	F _{netto;d} [kN]	F _{netto;d} [kN]	F _{netto;d} [kN]	F _{netto;d} [kN]
-7.00	644	863	778	2033	1532	1386						
-7.50	580	924	754	2154	1673	1476						
-8.00	602	996	746	2244	1746	1510						
-8.50	647	986	736	2070	1802	1533						
-9.00	675	1030	1137	1521	1606	1588						
-9.50	692	1190	1268	1589	1653	1660						
-10.00	657	1258	1345	1656	1701	1738						
-10.50	809	1319	1397	1689	1740	1811						
-11.00	819	1356	1428	1694	1780	1846						
-11.50	786	1403	1502	1748	1783	1867						
-12.00	828	1466	1784	1818	2165	1896						
-12.50	861	1441	1641	1831	2343	2096						
-13.00	873	1529	1728	1820	2549	2244						
-13.50	975	1590	1809	1855	2696	2371						
-14.00	980	1545	1858	1888	2824	2610						
-14.50	1013	1577	1854	1917	2880	2617						
-15.00	1052	1676	1817	1983	2947	2708						
-15.50	1081	1592	2704	2046	3174	2793						
-16.00	1114	1602	2534	2052	3419	2858						
-16.50	1140	1549	2595	2085	3628	2862						
-17.00	1186	1591	2712	2194	4002	2924						
-17.50	1361	1703	2781	2890	4033	3147						
-18.00	1424	1732	2790	3199	4179	3241						
-18.50	1476	1764	2489	3209	4307	3423						
-19.00	1584	1801	2533	3087	4433	3502						
-19.50	1669	1818	2509	4145	4533	3659						
-20.00	1665	1833	2504	3788	4553	3983						
-20.50	1658	1853	2528	3650	4906	4094						
-21.00	1671	1884	2573	3552	5158	4215						
-21.50	1702	1913	2596	3486	5289	4482						
-22.00	1733	1944	2612	3429	5388	4582						
-22.50	1769	1973	2699	3340	5484	4701						
-23.00	2148	2000	2748	3376	5681	4410						
-23.50	2310	2042	2887	3466	4956	4475						
-24.00	2472	2071	2947	3538	4283	4561						
-24.50	2603	2101	3025	3563	4156	4633						
-25.00	2694	2131	3263	3592	4125	4681						
-25.50	2791	2162	3713	3654	4032	4570						
-26.00	2907	2191	4578	3696	4008	4891						
-26.50	2817	2221	4481	3743	3975	5319						
-27.00	2897	2250	4620	3784	4034	5494						
-27.50	2940	2296	4609	3834	4008	5627						
-28.00	3017	2329	4253	3877	4046	5723						
-28.50	3098	2359	4133	3985	4081	6007						
-29.00	3161	2400	4106	4351	4110	5097						
-29.50	3225	2440	4067	4318	0	4994						
-30.00	3139	2476	4028	4271	0	4864						

Project : ZWO380 Funderingen
 Onderdeel : RLL-TBG380

RESULTATEN SI Ø610/850 druk (n=1)

Alle niveaus/hoogtes/peilmaten zijn t.o.v.: N.A.P.

Sondering 312.S03 19-1008_43 328.S02

Niveau [m]	F _{netto;d} [kN]	F _{netto;d} [kN]	F _{netto;d} [kN]
-7.00	1129	1863	1995
-7.50	1533	1963	2102
-8.00	2177	2063	2199
-8.50	2334	2160	2261
-9.00	2505	2260	2509
-9.50	2576	2344	2671
-10.00	2759	2659	2873
-10.50	2789	2723	3038
-11.00	2922	2793	3180
-11.50	3052	2903	3252
-12.00	3198	2998	3356
-12.50	3160	3010	3464
-13.00	3331	3054	3287
-13.50	3532	3216	3349
-14.00	3603	3295	3414
-14.50	3556	3294	3494
-15.00	3590	3732	3543
-15.50	3638	3660	3519
-16.00	3713	3554	3672
-16.50	3704	3386	3825
-17.00	3718	3370	3956
-17.50	3238	3430	3997
-18.00	3338	3481	3632
-18.50	3411	3511	4395
-19.00	3482	3530	4499
-19.50	3422	3625	4746
-20.00	3443	3827	4908
-20.50	3866	3937	5184
-21.00	4116	4121	5348
-21.50	4319	4655	5280
-22.00	4521	4777	5436
-22.50	4667	0	5386
-23.00	4774	0	5520
-23.50	4944	0	5590
-24.00	5177	0	5668
-24.50	4574	0	5787
-25.00	4521	0	5707
-25.50	4449	0	5501
-26.00	4444	0	0
-26.50	4436	0	0
-27.00	4401	0	0
-27.50	4429	0	0
-28.00	4458	0	0
-28.50	4487	0	0
-29.00	4563	0	0
-29.50	0	0	0
-30.00	0	0	0

Project : ZWO380 Funderingen
 Onderdeel : RLL-TBG380

SAMENVATTINGSTABEL SI Ø610/850 druk (n=1)

Uitgangspunten

- paal : SI Ø610/850
 - paaltype : In de grond gevormde geschroefde paal; groutinjectie
 - schachtafmeting : 730 mm
 Paalklassefactor α_p : 0.63
 Factor α_s (tabel 7.c EC 7.1) : 0.009 (zandlagen; voor kleilagen zie tabel 7.d)
 Correlatiefactor $\xi_{3(n=1)}$: 1.39

Alle niveaus/hoogtes/peilmaten zijn t.o.v.: N.A.P.

sondering	maaiveld niveau	paalpunt niveau	Bezwijkdraagvermogen			Rekenwaarden		
			$R_{t,real}$ [kN]	$R_{s,real}$ [kN]	$R_{c,real}$ [kN]	$R_{c,d}$ [kN]	$F_{nk,r,d}$ [kN]	$R_{z,netto;d}$ [kN]
19-1008_1	2.12	-7.00	126.5	0.0	126.5	75.8	-142.7	-66.9
		-7.50	221.6	2.9	224.5	134.6	-142.7	-8.1
		-8.00	215.1	37.2	252.2	151.2	-142.7	8.5
		-8.50	190.7	75.9	266.6	159.8	-142.7	17.1
		-9.00	399.3	87.6	486.9	291.9	-142.7	149.1
		-9.50	403.0	151.7	554.7	332.5	-142.7	189.8
		-10.00	416.9	208.7	625.6	375.1	-142.7	232.3
		-10.50	481.1	275.4	756.5	453.5	-142.7	310.8
		-11.00	657.5	320.8	978.2	586.5	-142.7	443.7
		-11.50	691.3	399.6	1090.9	654.0	-142.7	511.3
		-12.00	658.8	501.0	1159.8	695.3	-142.7	552.6
		-12.50	1360.0	568.3	1928.3	1156.0	-142.7	1013.3
		-13.00	1422.5	676.8	2099.3	1258.6	-142.7	1115.8
		-13.50	1552.7	785.2	2337.9	1401.6	-142.7	1258.9
		-14.00	1825.6	878.6	2704.1	1621.2	-142.7	1478.4
		-14.50	2124.2	1001.7	3125.8	1874.0	-142.7	1731.3
		-15.00	2186.3	1113.8	3300.1	1978.5	-142.7	1835.7
		-15.50	1986.3	1236.7	3223.0	1932.3	-142.7	1789.5
		-16.00	2300.4	1341.9	3642.3	2183.6	-142.7	2040.9
		-16.50	2446.6	1457.8	3904.4	2340.8	-142.7	2198.0
		-17.00	3066.9	1575.6	4642.6	2783.3	-142.7	2640.6
		-17.50	3693.9	1713.5	5407.4	3241.8	-142.7	3099.1
		-18.00	3688.4	1868.3	5556.8	3331.4	-142.7	3188.7
		-18.50	3048.8	2023.2	5072.0	3040.7	-142.7	2898.0
		-19.00	2925.1	2178.0	5103.0	3059.4	-142.7	2916.6
		-19.50	2721.1	2332.8	5053.9	3029.9	-142.7	2887.2
		-20.00	2484.0	2523.8	5007.9	3002.3	-142.7	2859.6
		-20.50	2506.7	2722.1	5228.8	3134.8	-142.7	2992.0
		-21.00	2503.8	2928.5	5432.3	3256.8	-142.7	3114.1
-21.50	4346.4	3070.6	7417.0	4446.6	-142.7	4303.9		
-22.00	6278.1	3225.4	9503.5	5697.6	-142.7	5554.8		
-22.50	6278.1	3380.2	9658.3	5790.4	-142.7	5647.6		
-23.00	6278.1	3535.0	9813.1	5883.2	-142.7	5740.4		
-23.50	6278.1	3689.8	9967.9	5976.0	-142.7	5833.2		
-24.00	6278.1	3844.6	10122.7	6068.8	-142.7	5926.0		
-24.50	6278.1	3999.4	10277.5	6161.6	-142.7	6018.8		
-25.00	6278.1	4154.2	10432.3	6254.4	-142.7	6111.7		
-25.50	6278.1	4309.1	10587.1	6347.2	-142.7	6204.5		
-26.00	6278.1	4463.9	10741.9	6440.0	-142.7	6297.3		
-26.50	6278.1	4618.7	10896.7	6532.8	-142.7	6390.1		
-27.00	6278.1	4773.5	11051.5	6625.6	-142.7	6482.9		
-27.50	6278.1	4928.3	11206.3	6718.4	-142.7	6575.7		
-28.00	6278.1	5083.1	11361.1	6811.2	-142.7	6668.5		
-28.50	6278.1	5237.9	11515.9	6904.0	-142.7	6761.3		
-29.00	6278.1	5392.7	11670.7	6996.8	-142.7	6854.1		
-29.50	6278.1	5547.5	11825.5	7089.7	-142.7	6946.9		
19-1008_6	11.00	-7.00	3761.5	1862.4	5623.9	3371.7	0.0	3371.7
		-7.50	4457.9	2017.2	6475.0	3881.9	0.0	3881.9
		-8.00	4868.9	2172.0	7040.8	4221.1	0.0	4221.1
		-8.50	5122.0	2326.8	7448.8	4465.7	0.0	4465.7
		-9.00	5174.4	2481.6	7656.0	4589.9	0.0	4589.9
		-9.50	5227.2	2636.4	7863.6	4714.4	0.0	4714.4
		-10.00	6275.5	2791.2	9066.7	5435.6	0.0	5435.6
		-10.50	6245.8	2946.0	9191.8	5510.7	0.0	5510.7
		-11.00	6076.5	3100.8	9177.3	5502.0	0.0	5502.0
		-11.50	6133.6	3255.6	9389.2	5629.0	0.0	5629.0
		-12.00	6124.0	3410.4	9534.4	5716.0	0.0	5716.0
		-12.50	6028.9	3565.2	9594.1	5751.9	0.0	5751.9
		-13.00	5951.5	3720.0	9671.5	5798.3	0.0	5798.3
		-13.50	6278.1	3874.8	10152.9	6086.9	0.0	6086.9
		-14.00	6278.1	4029.6	10307.7	6179.7	0.0	6179.7
		-14.50	6278.1	4184.4	10462.5	6272.5	0.0	6272.5
		-15.00	5727.2	4339.2	10066.4	6035.0	0.0	6035.0
		-15.50	3900.7	4494.0	8394.7	5032.8	0.0	5032.8
		-16.00	3722.5	4648.8	8371.4	5018.8	0.0	5018.8
		-16.50	3669.6	4803.6	8473.2	5079.8	0.0	5079.8
		-17.00	3498.7	4958.4	8457.1	5070.2	0.0	5070.2
-17.50	3329.5	5113.2	8442.8	5061.6	0.0	5061.6		
-18.00	3901.9	5268.0	9170.0	5497.6	0.0	5497.6		
-18.50	4817.8	5412.5	10230.3	6133.3	0.0	6133.3		
-19.00	4854.7	5567.3	10421.9	6248.2	0.0	6248.2		
-19.50	4896.6	5722.1	10618.7	6366.1	0.0	6366.1		
-20.00	4956.5	5876.9	10833.3	6494.8	0.0	6494.8		
-20.50	4991.8	6031.7	11023.4	6608.8	0.0	6608.8		
-21.00	5305.8	6186.5	11492.2	6889.8	0.0	6889.8		
166.S01	3.45	-7.00	3009.4	1016.6	4026.0	2413.7	-11.0	2402.7
		-7.50	3065.5	1171.5	4236.9	2540.1	-11.0	2529.1
		-8.00	3159.0	1326.3	4485.2	2689.0	-11.0	2678.0
		-8.50	3269.8	1479.9	4749.6	2847.5	-11.0	2836.5
		-9.00	3201.1	1633.3	4834.4	2898.3	-11.0	2887.3
		-9.50	3223.6	1784.5	5008.1	3002.5	-11.0	2991.5
		-10.00	2871.6	1939.3	4811.0	2884.3	-11.0	2873.3
-10.50	2802.8	2094.1	4896.9	2935.8	-11.0	2924.8		
-11.00	2801.0	2248.9	5049.9	3027.5	-11.0	3016.6		

Project : ZWO380 Funderingen
Onderdeel : RLL-TBG380

Alle niveaus/hoogtes/peilmaten zijn t.o.v.: N.A.P.

Table with columns: sondering, maaiveld niveau, paalpunt niveau, Bezwijkdraagvermogen (R_b, R_s, R_c), and Rekenwaarden (R_d, F_b, R_netto,d). It lists data for three different levels: 19-1008_12 (3.57), 19-1008_17 (0.20), and 19-1008_20 (-0.03).

Project : ZWO380 Funderingen
 Onderdeel : RLL-TBG380

Alle niveaus/hoogtes/peilmaten zijn t.o.v.: N.A.P.

sondering	maaiveld niveau	paalpunt niveau	Bezwijkdraagvermogen			Rekenwaarden				
			R _{b,real} [kN]	R _{s,real} [kN]	R _{c,real} [kN]	R _{s;d} [kN]	F _{h,k;d} [kN]	R _{c,netto;d} [kN]		
19-1008_20	-0.03	-23.50	1351.1	2575.8	3927.0	2354.3	-44.0	2310.3		
		-24.00	1529.0	2667.1	4196.1	2515.7	-44.0	2471.7		
		-24.50	1651.6	2762.8	4414.4	2646.5	-44.0	2602.6		
		-25.00	1687.2	2880.6	4567.7	2738.4	-44.0	2694.5		
		-25.50	1740.6	2987.6	4728.2	2834.6	-44.0	2790.7		
		-26.00	1830.7	3092.3	4923.0	2951.4	-44.0	2907.5		
		-26.50	1585.8	3186.8	4772.6	2861.3	-44.0	2817.3		
		-27.00	1602.6	3302.2	4904.8	2940.5	-44.0	2896.6		
		-27.50	1573.9	3403.6	4977.5	2984.1	-44.0	2940.1		
		-28.00	1611.3	3495.2	5106.5	3061.5	-44.0	3017.5		
		-28.50	1637.7	3602.7	5240.3	3141.7	-44.0	3097.7		
		-29.00	1644.5	3702.2	5346.7	3205.4	-44.0	3161.5		
		-29.50	1669.9	3782.3	5452.2	3268.7	-44.0	3224.7		
		-30.00	1425.7	3883.4	5309.1	3182.9	-44.0	3138.9		
		19-1008_21	1.78	-7.00	1133.1	535.8	1668.9	1000.5	-137.2	863.3
				-7.50	1113.1	657.1	1770.2	1061.3	-137.2	924.0
				-8.00	1119.5	770.7	1890.2	1133.2	-137.2	996.0
-8.50	988.3			885.5	1873.7	1123.3	-137.2	986.1		
-9.00	1001.5			944.8	1946.3	1166.8	-137.2	1029.6		
-9.50	1224.4			989.5	2213.9	1327.3	-137.2	1190.1		
-10.00	1270.5			1057.6	2328.1	1395.7	-137.2	1258.5		
-10.50	1311.8			1117.3	2429.1	1456.3	-137.2	1319.1		
-11.00	1304.2			1185.8	2490.0	1492.8	-137.2	1355.6		
-11.50	1297.6			1272.3	2569.9	1540.7	-137.2	1403.5		
-12.00	1304.1			1369.4	2673.6	1602.9	-137.2	1465.6		
-12.50	1189.1			1444.0	2633.1	1578.6	-137.2	1441.4		
-13.00	1249.2			1530.2	2779.4	1666.3	-137.2	1529.1		
-13.50	1254.7			1625.6	2880.4	1726.8	-137.2	1589.6		
-14.00	1038.3			1767.6	2805.9	1682.2	-137.2	1545.0		
-14.50	948.9			1909.8	2858.7	1713.9	-137.2	1576.6		
-15.00	1010.8			2013.9	3024.7	1813.3	-137.2	1676.1		
-15.50	795.4			2089.7	2885.2	1729.7	-137.2	1592.5		
-16.00	663.9			2236.5	2900.4	1738.8	-137.2	1601.6		
-16.50	429.8			2382.9	2812.7	1686.3	-137.2	1549.1		
-17.00	474.6			2407.8	2882.4	1728.1	-137.2	1590.8		
-17.50	633.2			2436.9	3070.0	1840.6	-137.2	1703.3		
-18.00	625.1			2492.4	3117.4	1869.0	-137.2	1731.7		
-18.50	518.6			2653.0	3171.7	1901.5	-137.2	1764.2		
-19.00	467.3			2765.1	3232.4	1937.9	-137.2	1800.7		
-19.50	467.3			2793.6	3261.0	1955.0	-137.2	1817.8		
-20.00	470.8			2816.3	3287.1	1970.7	-137.2	1833.4		
-20.50	480.3			2838.7	3319.0	1989.8	-137.2	1852.6		
-21.00	509.7			2861.4	3371.0	2021.0	-137.2	1883.8		
-21.50	531.2			2888.7	3419.9	2050.3	-137.2	1913.1		
-22.00	551.9			2920.4	3472.2	2081.7	-137.2	1944.4		
-22.50	560.0			2959.1	3519.0	2109.7	-137.2	1972.5		
-23.00	566.6			2997.4	3564.1	2136.7	-137.2	1999.5		
-23.50	601.3			3034.3	3635.6	2179.6	-137.2	2042.4		
-24.00	605.4	3078.1	3683.5	2208.3	-137.2	2071.1				
-24.50	610.6	3123.1	3733.6	2238.4	-137.2	2101.2				
-25.00	612.2	3170.4	3782.6	2267.7	-137.2	2130.5				
-25.50	614.3	3220.1	3834.4	2298.8	-137.2	2161.6				
-26.00	616.3	3267.7	3884.1	2328.6	-137.2	2191.3				
-26.50	623.0	3310.8	3933.9	2358.4	-137.2	2221.2				
-27.00	626.7	3355.0	3981.7	2387.1	-137.2	2249.9				
-27.50	659.9	3398.4	4058.3	2433.0	-137.2	2295.8				
-28.00	667.9	3445.2	4113.1	2465.9	-137.2	2328.7				
-28.50	670.2	3493.5	4163.7	2496.2	-137.2	2359.0				
-29.00	692.1	3540.4	4232.5	2537.5	-137.2	2400.3				
-29.50	709.2	3589.7	4298.9	2577.3	-137.2	2440.1				
-30.00	716.9	3642.3	4359.2	2613.4	-137.2	2476.2				
251.S01	-1.05	-7.00	575.9	746.3	1322.2	792.7	-15.1	777.6		
		-7.50	417.2	866.1	1283.2	769.3	-15.1	754.3		
		-8.00	293.6	976.2	1269.8	761.3	-15.1	746.2		
		-8.50	202.4	1050.3	1252.7	751.0	-15.1	735.9		
		-9.00	859.6	1061.4	1921.0	1151.6	-15.1	1136.6		
		-9.50	1011.0	1129.8	2140.8	1283.4	-15.1	1268.4		
		-10.00	1035.2	1233.5	2268.8	1360.2	-15.1	1345.1		
		-10.50	1000.1	1355.5	2355.6	1412.2	-15.1	1397.2		
		-11.00	958.4	1448.2	2406.6	1442.8	-15.1	1427.7		
		-11.50	1026.3	1504.5	2530.8	1517.3	-15.1	1502.2		
		-12.00	1440.9	1560.4	3001.3	1799.3	-15.1	1784.3		
		-12.50	1107.2	1655.4	2762.6	1656.2	-15.1	1641.2		
		-13.00	1139.0	1767.9	2906.9	1742.7	-15.1	1727.7		
		-13.50	1168.1	1873.8	3041.9	1823.7	-15.1	1808.6		
		-14.00	1103.3	2021.0	3124.3	1873.1	-15.1	1858.0		
		-14.50	950.3	2167.3	3117.6	1869.1	-15.1	1854.0		
		-15.00	729.8	2325.7	3055.5	1831.8	-15.1	1816.8		
		-15.50	2139.0	2396.6	4535.7	2719.2	-15.1	2704.2		
		-16.00	1712.0	2539.5	4251.6	2548.9	-15.1	2533.8		
		-16.50	1659.7	2694.3	4354.0	2610.3	-15.1	2595.3		
		-17.00	1701.0	2847.4	4548.5	2726.9	-15.1	2711.8		
		-17.50	1669.8	2993.5	4663.3	2795.8	-15.1	2780.7		
		-18.00	1546.6	3131.5	4678.1	2804.6	-15.1	2789.5		
-18.50	891.3	3286.1	4177.4	2504.5	-15.1	2489.4				
-19.00	871.2	3379.0	4250.2	2548.1	-15.1	2533.0				
-19.50	731.1	3478.3	4209.4	2523.6	-15.1	2508.5				
-20.00	602.8	3598.7	4201.5	2518.9	-15.1	2503.8				
-20.50	475.2	3767.1	4242.2	2543.3	-15.1	2528.2				
-21.00	372.5	3944.4	4316.8	2588.0	-15.1	2572.9				
-21.50	337.7	4017.9	4355.6	2611.3	-15.1	2596.2				
-22.00	341.2	4040.9	4382.1	2627.2	-15.1	2612.1				
-22.50	455.0	4071.4	4526.4	2713.6	-15.1	2698.6				
-23.00	488.4	4120.2	4608.6	2762.9	-15.1	2747.9				

Project : ZWO380 Funderingen
Onderdeel : RLL-TBG380

Alle niveaus/hoogtes/peilmaten zijn t.o.v.: N.A.P.

Table with columns: sondering, maaiveld niveau, paalpunt niveau, Bezwijkdraagvermogen (R_b, R_s, R_c), Rekenwaarden (R_d, F_k, R_netto), and various numerical values for different sondering levels.

Project : ZWO380 Funderingen
 Onderdeel : RLL-TBG380

Alle niveaus/hoogtes/peilmaten zijn t.o.v.: N.A.P.

sondering	maaiveld niveau	paalpunt niveau	Bewijkdraagvermogen						Rekenwaarden		
			R _{b;real} [kN]	R _{s;real} [kN]	R _{c;real} [kN]	R _{e;d} [kN]	F _{bk;d} [kN]	R _{z;netto;d} [kN]			
312.S03	3.78	-24.50	1786.5	5842.2	7628.7	4573.6	0.0	4573.6			
		-25.00	1544.0	5997.0	7541.0	4521.0	0.0	4521.0			
		-25.50	1278.2	6142.4	7420.6	4448.8	0.0	4448.8			
		-26.00	1140.4	6272.3	7412.7	4444.1	0.0	4444.1			
		-26.50	976.0	6423.7	7399.7	4436.3	0.0	4436.3			
		-27.00	765.3	6575.1	7340.5	4400.8	0.0	4400.8			
		-27.50	731.8	6656.3	7388.1	4429.3	0.0	4429.3			
		-28.00	715.6	6720.7	7436.3	4458.2	0.0	4458.2			
		-28.50	713.5	6770.1	7483.6	4486.6	0.0	4486.6			
		-29.00	791.7	6818.6	7610.3	4562.5	0.0	4562.5			
		19-1008_43	9.88	-7.00	2028.6	1078.2	3106.8	1862.6	0.0	1862.6	
				-7.50	2079.8	1193.7	3273.5	1962.5	0.0	1962.5	
				-8.00	2127.5	1313.8	3441.4	2063.2	0.0	2063.2	
				-8.50	2176.4	1426.0	3602.4	2159.7	0.0	2159.7	
-9.00	2229.5			1540.6	3770.1	2260.2	0.0	2260.2			
-9.50	2252.4			1658.0	3910.4	2344.4	0.0	2344.4			
-10.00	2670.3			1765.0	4435.3	2659.0	0.0	2659.0			
-10.50	2648.9			1893.8	4542.7	2723.4	0.0	2723.4			
-11.00	2610.7			2048.6	4659.3	2793.3	0.0	2793.3			
-11.50	2638.7			2203.4	4842.1	2903.0	0.0	2903.0			
-12.00	2642.2			2358.1	5000.2	2997.7	0.0	2997.7			
-12.50	2509.7			2511.6	5021.3	3010.4	0.0	3010.4			
-13.00	2468.3			2625.8	5094.2	3054.1	0.0	3054.1			
-13.50	2640.5			2724.2	5364.7	3216.2	0.0	3216.2			
-14.00	2656.9			2838.9	5495.7	3294.8	0.0	3294.8			
-14.50	2532.2			2962.7	5494.9	3294.3	0.0	3294.3			
-15.00	3154.3			3071.0	6225.3	3732.2	0.0	3732.2			
-15.50	2898.5			3205.8	6104.3	3659.6	0.0	3659.6			
-16.00	2573.9			3354.6	5928.5	3554.3	0.0	3554.3			
-16.50	2138.4			3509.4	5647.8	3386.0	0.0	3386.0			
-17.00	1956.4			3664.2	5620.6	3369.7	0.0	3369.7			
-17.50	1907.4			3813.3	5720.7	3429.7	0.0	3429.7			
-18.00	1858.6			3948.3	5806.9	3481.4	0.0	3481.4			
-18.50	1786.9			4069.1	5856.0	3510.8	0.0	3510.8			
-19.00	1697.2			4190.1	5887.3	3529.5	0.0	3529.5			
-19.50	1759.3			4287.9	6047.2	3625.4	0.0	3625.4			
-20.00	1994.8			4388.9	6383.6	3827.1	0.0	3827.1			
-20.50	2051.0	4516.4	6567.4	3937.3	0.0	3937.3					
-21.00	2208.6	4664.4	6873.0	4120.5	0.0	4120.5					
-21.50	2977.5	4786.8	7764.3	4654.9	0.0	4654.9					
-22.00	3042.6	4925.5	7968.1	4777.0	0.0	4777.0					
328.S02	10.17	-7.00	1590.9	1736.8	3327.6	1995.0	0.0	1995.0			
		-7.50	1662.1	1844.6	3506.6	2102.3	0.0	2102.3			
		-8.00	1704.1	1963.4	3667.4	2198.7	0.0	2198.7			
		-8.50	1686.4	2085.2	3771.6	2261.2	0.0	2261.2			
		-9.00	1980.9	2204.1	4185.0	2509.0	0.0	2509.0			
		-9.50	2149.4	2305.9	4455.3	2671.0	0.0	2671.0			
		-10.00	2371.3	2420.6	4791.9	2872.9	0.0	2872.9			
		-10.50	2526.4	2541.1	5067.5	3038.1	0.0	3038.1			
		-11.00	2625.3	2679.6	5304.9	3180.4	0.0	3180.4			
		-11.50	2602.0	2821.9	5423.9	3251.7	0.0	3251.7			
		-12.00	2637.6	2959.4	5597.0	3355.5	0.0	3355.5			
		-12.50	2694.8	3083.6	5778.4	3464.3	0.0	3464.3			
		-13.00	2278.8	3204.8	5483.5	3287.5	0.0	3287.5			
		-13.50	2259.6	3327.3	5586.8	3349.4	0.0	3349.4			
		-14.00	2243.5	3451.1	5694.6	3414.0	0.0	3414.0			
		-14.50	2256.1	3571.3	5827.4	3493.6	0.0	3493.6			
		-15.00	2212.9	3696.5	5909.4	3542.8	0.0	3542.8			
		-15.50	2048.9	3820.1	5868.9	3518.5	0.0	3518.5			
		-16.00	2182.6	3942.7	6125.3	3672.2	0.0	3672.2			
		-16.50	2308.3	4071.1	6379.4	3824.6	0.0	3824.6			
		-17.00	2372.8	4225.9	6598.7	3956.1	0.0	3956.1			
		-17.50	2285.6	4380.7	6666.3	3996.6	0.0	3996.6			
		-18.00	1500.6	4558.4	6059.0	3632.5	0.0	3632.5			
		-18.50	2662.9	4668.6	7331.5	4395.4	0.0	4395.4			
		-19.00	2697.0	4807.2	7504.2	4498.9	0.0	4498.9			
		-19.50	2960.8	4955.0	7915.7	4745.7	0.0	4745.7			
		-20.00	3076.6	5109.8	8186.4	4907.9	0.0	4907.9			
-20.50	3383.0	5264.6	8647.6	5184.4	0.0	5184.4					
-21.00	3500.9	5419.4	8920.2	5347.9	0.0	5347.9					
-21.50	3232.8	5574.2	8806.9	5279.9	0.0	5279.9					
-22.00	3339.1	5729.0	9068.1	5436.5	0.0	5436.5					
-22.50	3099.6	5883.8	8983.4	5385.7	0.0	5385.7					
-23.00	3168.5	6038.6	9207.1	5519.8	0.0	5519.8					
-23.50	3130.6	6193.4	9324.0	5589.9	0.0	5589.9					
-24.00	3105.8	6348.2	9453.9	5667.8	0.0	5667.8					
-24.50	3174.7	6477.2	9651.9	5786.5	0.0	5786.5					
-25.00	2918.6	6601.1	9519.6	5707.2	0.0	5707.2					
-25.50	2454.0	6722.4	9176.4	5501.5	0.0	5501.5					

Project : ZWO380 Funderingen
 Onderdeel : RLL-TBG380

REKENGEGEVENS SI Ø762/950 druk

Berekening : Ontwerpend
 Rekenmethode : Drukpalen volgens NEN-EN 1997-1, art. 7.6.2
 Sondering(en) : 19-1008_1, 19-1008_6, 166.S01, 19-1008_11, 19-1008_12
 : 19-1008_17, 19-1008_20, 19-1008_21, 251.S01, 19-1008_29
 : 283.S02, 19-1008_35, 312.S03, 19-1008_43, 328.S02

Stijf bouwwerk : NEE
 Paalgroep : NEE
 Aantal sonderingen : 15
 Factor $\xi_{s(n-1)}$: 1.39 (handmatig)
 Factor $\xi_{s(gem)}$: 1.39 (handmatig)
 Factor $\xi_{s(min)}$: 1.39 (handmatig)
 Weerstandsfactor γ_R : 1.20
 $\gamma_{f,nk}$: 1.0
 $R_{b,calc,max;i}$ begrenzen op $0.75 * R_{b,calc,max;i}$: NEE
 UGT draagvermogen zonder negatieve kleef : NEE

Paal : SI Ø762/950
 Niveau paalkop [m] : N.A.P. 0.00
 Bovenbel. [kN/m²] : 0.00

PAALPUNTNIVEAUS SI Ø762/950

Alle niveaus/hoogtes/peilmaten zijn t.o.v. : N.A.P.

Nr Beginniveau Eindniveau Stapgrootte
 [m] [m] [m]

1	-8.00	-30.00	0.50
---	-------	--------	------

RESULTATEN SI Ø762/950 druk (n=1)

Alle niveaus/hoogtes/peilmaten zijn t.o.v. : N.A.P.

Sondering	19-1008_1	19-1008_6	166.S01	19-1008_11	19-1008_12	19-1008_17
Niveau	$F_{netto;d}$	$F_{netto;d}$	$F_{netto;d}$	$F_{netto;d}$	$F_{netto;d}$	$F_{netto;d}$
[m]	[kN]	[kN]	[kN]	[kN]	[kN]	[kN]
-8.00	34	5504	3437	402	1871	-29
-8.50	89	5803	3463	440	1895	-4
-9.00	223	5934	3600	440	1920	66
-9.50	270	6181	3531	491	1924	574
-10.00	321	6752	3636	546	1946	351
-10.50	448	6802	3770	583	1982	1161
-11.00	596	7035	3876	633	1983	2105
-11.50	677	7217	3832	646	2028	1986
-12.00	738	7374	3812	619	2038	2190
-12.50	1345	7450	3871	1537	2050	2351
-13.00	1464	7512	4287	1790	2123	2396
-13.50	1694	7960	4717	1918	2209	2479
-14.00	1924	8070	4855	2049	2251	2579
-14.50	2207	7824	5017	2156	2285	3000
-15.00	2372	6376	5251	2246	2321	2233
-15.50	2290	6420	5702	2380	2437	2320
-16.00	2619	6381	5837	2642	2502	2422
-16.50	2795	6446	5930	2748	2562	2516
-17.00	3591	6413	6069	2898	2636	2664
-17.50	3961	6382	6233	3654	2826	2563
-18.00	3622	7255	6394	4265	3098	2481
-18.50	3769	7834	6544	4407	3220	2987
-19.00	3778	7950	6653	4596	3718	3127
-19.50	3744	8079	0	4708	4107	3253
-20.00	3681	8223	0	4243	4372	3402
-20.50	3840	0	0	4179	4312	3632
-21.00	4177	0	0	4193	4860	3495
-21.50	5816	0	0	4270	5031	3888
-22.00	7334	0	0	4136	5219	3956
-22.50	7443	0	0	4110	5146	4032
-23.00	7552	0	0	4075	4873	4025
-23.50	7662	0	0	4416	4883	4084
-24.00	7771	0	0	4536	4892	4172
-24.50	7880	0	0	4580	4727	4232
-25.00	7990	0	0	4830	4758	4327
-25.50	8099	0	0	5712	4768	4418
-26.00	8208	0	0	5817	4851	3567
-26.50	8318	0	0	5893	4938	3598
-27.00	8427	0	0	6019	5010	3670
-27.50	8536	0	0	6199	5072	3735
-28.00	8646	0	0	6676	6054	3782
-28.50	8755	0	0	6941	0	3749
-29.00	8864	0	0	7529	0	3600
-29.50	0	0	0	8297	0	4665
-30.00	0	0	0	8455	0	5110

Project : ZWO380 Funderingen
 Onderdeel : RLL-TBG380

RESULTATEN SI Ø762/950 druk (n=1)

Alle niveaus/hoogtes/peilmaten zijn t.o.v.: N.A.P.

Niveau [m]	19-1008_20	19-1008_21	251.S01	19-1008_29	283.S02	19-1008_35
	F _{nettoord} [kN]	F _{nettoord} [kN]	F _{nettoord} [kN]	F _{nettoord} [kN]	F _{nettoord} [kN]	F _{nettoord} [kN]
-8.00	776	1277	910	2523	2235	1962
-8.50	828	1246	955	1823	2005	1984
-9.00	854	1317	1516	1901	2073	2074
-9.50	867	1508	1613	1978	2129	2144
-10.00	821	1594	1702	2057	2184	2281
-10.50	1006	1694	1753	2102	2228	2334
-11.00	1030	1757	1777	2079	2271	2367
-11.50	975	1814	1876	2190	2308	2383
-12.00	1036	1760	1957	2190	2785	2415
-12.50	1074	1848	2060	2223	3043	2702
-13.00	1085	1958	2164	2192	3311	2875
-13.50	1188	1845	2262	2234	3461	3052
-14.00	1216	1841	2310	2271	3612	3247
-14.50	1260	1977	2284	2306	3664	3348
-15.00	1301	1913	2339	2417	3786	3454
-15.50	1334	1976	3062	2472	4025	3556
-16.00	1375	1970	3146	2466	4340	3628
-16.50	1404	1879	3273	2506	4686	3614
-17.00	1502	1950	3391	2725	4927	3724
-17.50	1699	2066	3462	3694	5102	3977
-18.00	1775	2100	2956	4025	5285	4149
-18.50	1883	2140	2990	4024	5479	4321
-19.00	1957	2178	2977	4031	5663	4425
-19.50	2011	2198	2997	4591	5782	4733
-20.00	2069	2216	3009	4435	5786	5081
-20.50	2044	2241	3038	4371	6364	5207
-21.00	2040	2280	3078	4325	6573	5357
-21.50	2073	2317	3101	4239	6737	5631
-22.00	2111	2354	3120	4108	6860	5804
-22.50	2233	2387	3235	4050	6979	5467
-23.00	2700	2422	3317	4089	5898	5542
-23.50	2885	2474	3481	4213	5202	5654
-24.00	3120	2512	3550	4278	5072	5742
-24.50	3239	2545	3716	4297	4995	5824
-25.00	3355	2582	3996	4343	4963	5873
-25.50	3466	2618	4564	4421	4840	5727
-26.00	3377	2653	5368	4468	4810	6175
-26.50	3484	2688	5607	4523	4768	6687
-27.00	3517	2722	5464	4568	4760	6907
-27.50	3611	2784	5147	4628	4801	7062
-28.00	3707	2825	5039	4678	4844	7165
-28.50	3800	2862	4970	4772	4882	6154
-29.00	3884	2915	4859	5163	0	6089
-29.50	3787	2961	4905	5195	0	5950
-30.00	3877	0	4846	5132	0	5792

RESULTATEN SI Ø762/950 druk (n=1)

Alle niveaus/hoogtes/peilmaten zijn t.o.v.: N.A.P.

Niveau [m]	312.S03	19-1008_43	328.S02
	F _{nettoord} [kN]	F _{nettoord} [kN]	F _{nettoord} [kN]
-8.00	2834	2663	2773
-8.50	3020	2790	2839
-9.00	3227	2908	3161
-9.50	3294	3003	3356
-10.00	3391	3374	3620
-10.50	3526	3464	3819
-11.00	3694	3562	3938
-11.50	3804	3656	4075
-12.00	4020	3775	4230
-12.50	3937	3807	4035
-13.00	4203	3901	4116
-13.50	4369	4119	4213
-14.00	4403	4213	4285
-14.50	4466	4202	4378
-15.00	4548	4575	4276
-15.50	4599	4362	4403
-16.00	4688	4204	4601
-16.50	4659	4160	4796
-17.00	3878	4213	4959
-17.50	3988	4277	4996
-18.00	4115	4335	4615
-18.50	4201	4361	5512
-19.00	4283	4371	5628
-19.50	4183	4507	5935
-20.00	4318	4759	6148
-20.50	4767	4884	6475
-21.00	5088	5139	6380
-21.50	5396	5826	6564
-22.00	5596	0	6512
-22.50	5750	0	6686
-23.00	5882	0	6763
-23.50	6132	0	6903
-24.00	5534	0	6975
-24.50	5479	0	6894
-25.00	5347	0	6650
-25.50	5315	0	0
-26.00	5307	0	0
-26.50	5332	0	0
-27.00	5279	0	0
-27.50	5310	0	0
-28.00	5342	0	0
-28.50	5375	0	0
-29.00	0	0	0

Project : ZWO380 Funderingen
Onderdeel : RLL-TBG380

-29.50 0 0 0
-30.00 0 0 0

SAMENVATTINGSTABEL SI Ø762/950 druk (n=1)

Uitgangspunten
- paal : SI Ø762/950
- paaltype : In de grond gevormde geschroefde paal; groutinjectie
- schachtafmeting : 860 mm
Paalklassefactor α_p : 0.63
Factor α_s (tabel 7.c EC 7.1) : 0.009 (zandlagen; voor kleilagen zie tabel 7.d)
Correlatiefactor $\xi_{3(n-1)}$: 1.39

Alle niveaus/hoogtes/peilmaten zijn t.o.v.: N.A.P.

sondering	maaiveld niveau	paalpunt niveau	Bewijkdraagvermogen			Rekenwaarden		
			$R_{z,paal}$ [kN]	$R_{s,paal}$ [kN]	$R_{z,real}$ [kN]	$R_{z,d}$ [kN]	$F_{nk,z,d}$ [kN]	$R_{z,netto,d}$ [kN]
19-1008_1	2.12	-8.00	294.1	43.8	337.9	202.6	-168.2	34.4
		-8.50	339.6	89.4	429.0	257.2	-168.2	89.0
		-9.00	549.9	103.2	653.1	391.5	-168.2	223.4
		-9.50	552.8	178.7	731.4	438.5	-168.2	270.4
		-10.00	569.5	245.8	815.3	488.8	-168.2	320.6
		-10.50	702.5	324.4	1026.9	615.7	-168.2	447.5
		-11.00	897.4	377.9	1275.3	764.6	-168.2	596.4
		-11.50	938.5	470.7	1409.2	844.8	-168.2	676.7
		-12.00	921.8	590.3	1512.1	906.5	-168.2	738.4
		-12.50	1853.7	669.5	2523.1	1512.7	-168.2	1344.5
		-13.00	1925.9	797.3	2723.2	1632.6	-168.2	1464.5
		-13.50	2181.4	925.0	3106.5	1862.4	-168.2	1694.2
		-14.00	2455.4	1035.0	3490.4	2092.6	-168.2	1924.4
		-14.50	2781.8	1180.0	3961.8	2375.2	-168.2	2207.0
		-15.00	2924.9	1312.1	4237.0	2540.1	-168.2	2372.0
		-15.50	2642.6	1456.9	4099.5	2457.7	-168.2	2289.6
		-16.00	3067.9	1580.8	4648.8	2787.0	-168.2	2618.9
		-16.50	3225.6	1717.4	4943.0	2963.4	-168.2	2795.3
		-17.00	4413.5	1856.2	6269.7	3758.8	-168.2	3590.7
		-17.50	4868.9	2018.7	6887.6	4129.3	-168.2	3961.1
		-18.00	4120.4	2201.1	6321.5	3789.9	-168.2	3621.7
		-18.50	4183.7	2383.4	6567.2	3937.2	-168.2	3769.0
		-19.00	4016.6	2565.8	6582.4	3946.3	-168.2	3778.1
		-19.50	3776.6	2748.2	6524.7	3911.7	-168.2	3743.6
		-20.00	3447.5	2973.3	6420.8	3849.4	-168.2	3681.2
		-20.50	3478.9	3206.9	6685.8	4008.3	-168.2	3840.1
		-21.00	3797.1	3450.0	7247.1	4344.8	-168.2	4176.6
		-21.50	6363.8	3617.5	9981.2	5984.0	-168.2	5815.8
		-22.00	8713.2	3799.8	12513.0	7501.8	-168.2	7333.7
-22.50	8713.2	3982.2	12695.4	7611.2	-168.2	7443.0		
-23.00	8713.2	4164.6	12877.8	7720.5	-168.2	7552.3		
-23.50	8713.2	4346.9	13060.1	7829.8	-168.2	7661.7		
-24.00	8713.2	4529.3	13242.5	7939.2	-168.2	7771.0		
-24.50	8713.2	4711.7	13424.9	8048.5	-168.2	7880.3		
-25.00	8713.2	4894.0	13607.3	8157.8	-168.2	7989.7		
-25.50	8713.2	5076.4	13789.6	8267.2	-168.2	8099.0		
-26.00	8713.2	5258.8	13972.0	8376.5	-168.2	8208.3		
-26.50	8713.2	5441.2	14154.4	8485.8	-168.2	8317.7		
-27.00	8713.2	5623.5	14336.7	8595.2	-168.2	8427.0		
-27.50	8713.2	5805.9	14519.1	8704.5	-168.2	8536.3		
-28.00	8713.2	5988.3	14701.5	8813.8	-168.2	8645.7		
-28.50	8713.2	6170.6	14883.8	8923.2	-168.2	8755.0		
-29.00	8713.2	6353.0	15066.2	9032.5	-168.2	8864.3		
19-1008_6	11.00	-8.00	6622.1	2558.8	9180.9	5504.2	0.0	5504.2
		-8.50	6937.6	2741.2	9678.7	5802.6	0.0	5802.6
		-9.00	6973.7	2923.5	9897.2	5933.6	0.0	5933.6
		-9.50	7204.7	3105.9	10310.6	6181.4	0.0	6181.4
		-10.00	7974.9	3288.3	11263.2	6752.5	0.0	6752.5
		-10.50	7875.3	3470.6	11346.0	6802.1	0.0	6802.1
		-11.00	8082.2	3653.0	11735.2	7035.5	0.0	7035.5
		-11.50	8203.2	3835.4	12038.5	7217.4	0.0	7217.4
		-12.00	8282.8	4017.7	12300.6	7374.4	0.0	7374.4
		-12.50	8226.4	4200.1	12426.5	7449.9	0.0	7449.9
		-13.00	8148.1	4382.5	12530.6	7512.3	0.0	7512.3
		-13.50	8713.2	4564.8	13278.1	7960.5	0.0	7960.5
		-14.00	8713.2	4747.2	13460.4	8069.8	0.0	8069.8
		-14.50	8120.1	4929.6	13049.7	7823.6	0.0	7823.6
		-15.00	5522.5	5112.0	10634.5	6375.6	0.0	6375.6
		-15.50	5413.7	5294.3	10708.0	6419.7	0.0	6419.7
		-16.00	5166.4	5476.7	10643.1	6380.8	0.0	6380.8
-16.50	5092.9	5659.1	10752.0	6446.0	0.0	6446.0		
-17.00	4855.8	5841.4	10697.2	6413.2	0.0	6413.2		
-17.50	4621.0	6023.8	10644.8	6381.8	0.0	6381.8		
-18.00	5895.7	6206.2	12101.9	7255.3	0.0	7255.3		
-18.50	6691.2	6376.3	13067.5	7834.2	0.0	7834.2		
-19.00	6701.8	6558.7	13260.5	7949.9	0.0	7949.9		
-19.50	6735.0	6741.1	13476.0	8079.2	0.0	8079.2		
-20.00	6793.1	6923.4	13716.5	8223.3	0.0	8223.3		
166.S01	3.45	-8.00	4192.9	1562.4	5755.3	3450.4	-12.9	3437.5
		-8.50	4054.8	1743.4	5798.2	3476.1	-12.9	3463.2
		-9.00	4102.7	1924.2	6026.8	3613.2	-12.9	3600.3
		-9.50	3808.8	2102.3	5911.1	3543.8	-12.9	3530.9
		-10.00	3801.2	2284.7	6085.9	3648.6	-12.9	3635.7
		-10.50	3843.1	2467.1	6310.1	3783.1	-12.9	3770.1
		-11.00	3837.4	2649.4	6486.8	3889.0	-12.9	3876.0
		-11.50	3581.2	2831.8	6413.1	3844.8	-12.9	3831.8
		-12.00	3380.8	2999.4	6380.2	3825.1	-12.9	3812.1
		-12.50	3338.0	3141.0	6479.0	3884.3	-12.9	3871.4
		-13.00	3898.5	3273.5	7172.0	4299.8	-12.9	4286.8
-13.50	4482.3	3408.0	7890.3	4730.4	-12.9	4717.5		

Project : ZWO380 Funderingen
Onderdeel : RLL-TBG380

Alle niveaus/hoogtes/peilmaten zijn t.o.v.: N.A.P.

Table with columns: sondering, maaiveld niveau, paalpunt niveau, Bezwijkdraagvermogen (Rb,real, Rr,real, Rc,real), Rekenwaarden (Rc,d, Fhk,d, Rn,netto,d). Rows include data for sondering 19-1008_12, 19-1008_17, and 19-1008_20.

Project : ZWO380 Funderingen
Onderdeel : RLL-TBG380

Alle niveaus/hoogtes/peilmaten zijn t.o.v.: N.A.P.

sondering	maai­veld niveau	paalpunt niveau	Be­zijk­draag­ver­mogen			Re­ken­waar­den		
			R _{b,real} [kN]	R _{r,real} [kN]	R _{c,real} [kN]	R _{r,d} [kN]	F _{h,k,d} [kN]	R _{c,netto,d} [kN]
19-1008_21	1.78	-8.00	1491.2	908.0	2399.1	1438.3	-161.7	1276.7
		-8.50	1304.1	1043.1	2347.3	1407.2	-161.7	1245.6
		-9.00	1352.6	1113.1	2465.7	1478.2	-161.7	1316.5
		-9.50	1619.8	1165.7	2785.6	1670.0	-161.7	1508.3
		-10.00	1682.5	1245.9	2928.3	1755.6	-161.7	1593.9
		-10.50	1778.2	1316.3	3094.5	1855.2	-161.7	1693.6
		-11.00	1803.4	1397.0	3200.4	1918.7	-161.7	1757.1
		-11.50	1795.9	1498.9	3294.8	1975.3	-161.7	1813.6
		-12.00	1591.3	1613.3	3204.6	1921.2	-161.7	1759.5
		-12.50	1650.3	1701.2	3351.5	2009.3	-161.7	1847.6
		-13.00	1733.7	1802.7	3536.4	2120.2	-161.7	1958.5
		-13.50	1431.6	1915.1	3346.7	2006.4	-161.7	1844.8
		-14.00	1257.5	2082.3	3339.8	2002.3	-161.7	1840.6
		-14.50	1317.0	2249.9	3566.9	2138.4	-161.7	1976.7
		-15.00	1088.1	2372.5	3460.6	2074.7	-161.7	1913.0
		-15.50	1104.0	2461.9	3565.9	2137.8	-161.7	1976.1
		-16.00	921.4	2634.7	3556.2	2132.0	-161.7	1970.3
		-16.50	596.5	2807.3	3403.8	2040.7	-161.7	1879.0
		-17.00	684.9	2836.6	3521.5	2111.2	-161.7	1949.5
		-17.50	844.2	2870.8	3715.1	2227.3	-161.7	2065.6
		-18.00	835.6	2936.2	3771.8	2261.3	-161.7	2099.6
		-18.50	714.2	3125.5	3839.7	2302.0	-161.7	2140.3
		-19.00	645.5	3257.5	3903.0	2339.9	-161.7	2178.2
		-19.50	644.7	3291.1	3935.8	2359.6	-161.7	2197.9
		-20.00	648.7	3317.8	3966.5	2378.0	-161.7	2216.3
		-20.50	662.8	3344.3	4007.1	2402.3	-161.7	2240.7
		-21.00	702.3	3370.9	4073.3	2442.0	-161.7	2280.3
		-21.50	731.0	3403.2	4134.2	2478.5	-161.7	2316.8
		-22.00	756.3	3440.4	4196.7	2516.0	-161.7	2354.3
-22.50	765.7	3486.0	4251.7	2549.0	-161.7	2387.3		
-23.00	779.0	3531.2	4310.3	2584.1	-161.7	2422.4		
-23.50	821.4	3574.7	4396.1	2635.5	-161.7	2473.9		
-24.00	834.0	3626.2	4460.2	2674.0	-161.7	2512.3		
-24.50	836.1	3679.2	4515.3	2707.0	-161.7	2545.4		
-25.00	841.4	3735.0	4576.4	2743.6	-161.7	2582.0		
-25.50	843.1	3793.6	4636.7	2779.8	-161.7	2618.1		
-26.00	845.1	3849.7	4694.8	2814.6	-161.7	2653.0		
-26.50	853.2	3900.4	4753.7	2849.9	-161.7	2688.2		
-27.00	857.3	3952.5	4809.7	2883.5	-161.7	2721.9		
-27.50	909.1	4003.6	4912.7	2945.3	-161.7	2783.6		
-28.00	923.2	4058.7	4981.9	2986.7	-161.7	2825.1		
-28.50	927.5	4115.7	5043.2	3023.5	-161.7	2861.8		
-29.00	961.0	4170.9	5131.9	3076.7	-161.7	2915.0		
-29.50	979.5	4228.9	5208.4	3122.6	-161.7	2960.9		
251.S01	-1.05	-8.00	397.9	1150.0	1547.9	928.0	-17.8	910.3
		-8.50	385.3	1237.3	1622.6	972.8	-17.8	955.0
		-9.00	1307.1	1250.4	2557.5	1533.3	-17.8	1515.5
		-9.50	1388.7	1331.0	2719.7	1630.5	-17.8	1612.8
		-10.00	1415.6	1453.2	2868.8	1719.9	-17.8	1702.2
		-10.50	1356.4	1596.9	2953.4	1770.6	-17.8	1752.8
		-11.00	1288.3	1706.1	2994.4	1795.2	-17.8	1777.5
		-11.50	1386.5	1772.4	3158.9	1893.8	-17.8	1876.1
		-12.00	1456.4	1838.2	3294.6	1975.2	-17.8	1957.4
		-12.50	1515.7	1950.2	3465.9	2077.9	-17.8	2060.1
		-13.00	1557.0	2082.7	3639.6	2182.0	-17.8	2164.3
		-13.50	1594.4	2207.4	3801.9	2279.3	-17.8	2261.5
		-14.00	1501.5	2380.9	3882.5	2327.6	-17.8	2309.9
		-14.50	1286.3	2553.3	3839.6	2301.9	-17.8	2284.2
		-15.00	1191.7	2739.9	3931.6	2357.1	-17.8	2339.3
		-15.50	2313.0	2823.4	5136.4	3079.4	-17.8	3061.6
		-16.00	2285.3	2991.8	5277.1	3163.7	-17.8	3146.0
		-16.50	2314.4	3174.1	5488.5	3290.5	-17.8	3272.7
		-17.00	2330.9	3354.5	5685.4	3408.5	-17.8	3390.7
		-17.50	2278.3	3526.6	5804.9	3480.1	-17.8	3462.4
		-18.00	1271.1	3689.2	4960.3	2973.8	-17.8	2956.1
		-18.50	1145.8	3871.3	5017.1	3007.9	-17.8	2990.1
		-19.00	1013.8	3980.8	4994.6	2994.4	-17.8	2976.6
		-19.50	930.4	4097.7	5028.2	3014.5	-17.8	2996.7
		-20.00	809.4	4239.5	5048.9	3026.9	-17.8	3009.2
		-20.50	659.5	4437.9	5097.4	3056.0	-17.8	3038.2
		-21.00	516.9	4646.8	5163.7	3095.7	-17.8	3078.0
		-21.50	468.6	4733.4	5202.1	3118.7	-17.8	3101.0
		-22.00	472.6	4760.6	5233.2	3137.4	-17.8	3119.6
-22.50	629.6	4796.4	5426.0	3253.0	-17.8	3235.2		
-23.00	708.0	4853.9	5561.9	3334.5	-17.8	3316.7		
-23.50	907.3	4929.1	5836.4	3499.1	-17.8	3481.3		
-24.00	919.5	5030.9	5950.4	3567.4	-17.8	3549.6		
-24.50	1104.5	5123.6	6228.1	3733.9	-17.8	3716.1		
-25.00	1486.9	5207.7	6694.7	4013.6	-17.8	3995.8		
-25.50	2284.5	5358.6	7643.2	4582.2	-17.8	4564.5		
-26.00	3403.7	5579.9	8983.6	5385.8	-17.8	5368.1		
-26.50	3588.9	5793.1	9382.0	5624.7	-17.8	5607.0		
-27.00	3168.6	5975.5	9144.0	5482.0	-17.8	5464.3		
-27.50	2457.4	6157.8	8615.3	5165.0	-17.8	5147.3		
-28.00	2094.1	6340.2	8434.4	5056.6	-17.8	5038.8		
-28.50	1796.6	6522.6	8319.2	4987.5	-17.8	4969.8		
-29.00	1429.6	6704.7	8134.4	4876.7	-17.8	4859.0		
-29.50	1383.3	6827.1	8210.4	4922.3	-17.8	4904.5		
-30.00	1139.3	6973.0	8112.3	4863.5	-17.8	4845.8		
19-1008_29	0.79	-8.00	2518.7	1704.2	4222.9	2531.7	-8.6	2523.1
		-8.50	1184.7	1869.7	3054.4	1831.2	-8.6	1822.6
		-9.00	1172.0	2013.7	3185.7	1909.9	-8.6	1901.3
		-9.50	1164.8	2148.1	3313.0	1986.2	-8.6	1977.6
		-10.00	1172.1	2273.8	3445.9	2065.9	-8.6	2057.3

Project : ZWO380 Funderingen
 Onderdeel : RLL-TBG380

Alle niveaus/hoogtes/peilmaten zijn t.o.v.: N.A.P.

sondering	maaiveld niveau	paalpunt niveau	Beziijkdraagvermogen			Rekenwaarden		
			R _{b,real} [kN]	R _{r,real} [kN]	R _{c,real} [kN]	R _d [kN]	F _{bk;d} [kN]	R _{c,netto;d} [kN]
<hr/>								
19-1008_29	0.79	-10.50	1101.1	2419.7	3520.8	2110.8	-8.6	2102.2
		-11.00	917.5	2564.4	3481.9	2087.5	-8.6	2078.9
		-11.50	941.3	2726.1	3667.4	2198.7	-8.6	2190.1
		-12.00	865.6	2802.1	3667.7	2198.9	-8.6	2190.3
		-12.50	754.4	2967.1	3721.5	2231.1	-8.6	2222.5
		-13.00	577.0	3094.3	3671.3	2201.0	-8.6	2192.4
		-13.50	592.7	3147.5	3740.2	2242.3	-8.6	2233.8
		-14.00	592.9	3210.3	3803.2	2280.1	-8.6	2271.5
		-14.50	606.3	3253.8	3860.1	2314.2	-8.6	2305.6
		-15.00	754.1	3291.1	4045.2	2425.2	-8.6	2416.6
		-15.50	800.9	3335.9	4136.8	2480.1	-8.6	2471.5
		-16.00	677.9	3450.1	4128.1	2474.9	-8.6	2466.3
		-16.50	702.2	3492.4	4194.6	2514.8	-8.6	2506.2
		-17.00	1024.8	3535.1	4559.9	2733.7	-8.6	2725.1
		-17.50	2579.3	3596.6	6176.0	3702.6	-8.6	3694.0
		-18.00	2980.8	3747.2	6728.0	4033.6	-8.6	4025.0
		-18.50	2797.5	3929.6	6727.1	4033.0	-8.6	4024.5
		-19.00	2631.6	4106.2	6737.8	4039.5	-8.6	4030.9
		-19.50	3429.5	4242.5	7672.0	4599.5	-8.6	4590.9
		-20.00	2986.5	4424.9	7411.3	4443.2	-8.6	4434.6
		-20.50	2697.4	4607.2	7304.7	4379.3	-8.6	4370.7
		-21.00	2439.2	4789.6	7228.8	4333.8	-8.6	4325.2
		-21.50	2112.4	4972.0	7084.4	4247.2	-8.6	4238.6
		-22.00	1712.4	5154.3	6866.7	4116.7	-8.6	4108.1
		-22.50	1404.5	5365.9	6770.3	4059.0	-8.6	4050.4
		-23.00	1312.4	5522.2	6834.7	4097.5	-8.6	4088.9
		-23.50	1411.5	5630.4	7041.9	4221.8	-8.6	4213.2
		-24.00	1392.2	5757.7	7149.9	4286.5	-8.6	4277.9
		-24.50	1294.2	5887.2	7181.4	4305.4	-8.6	4296.8
		-25.00	1233.2	6024.8	7258.0	4351.3	-8.6	4342.7
		-25.50	1277.7	6110.2	7387.9	4429.2	-8.6	4420.6
-26.00	1257.7	6208.5	7466.2	4476.1	-8.6	4467.5		
-26.50	1259.0	6300.0	7559.1	4531.8	-8.6	4523.2		
-27.00	1219.0	6415.1	7634.1	4576.8	-8.6	4568.2		
-27.50	1232.3	6502.0	7734.2	4636.8	-8.6	4628.2		
-28.00	1231.1	6586.7	7817.7	4686.9	-8.6	4678.3		
-28.50	1303.8	6670.8	7974.6	4780.9	-8.6	4772.3		
-29.00	1863.1	6763.5	8626.6	5171.8	-8.6	5163.2		
-29.50	1769.5	6910.0	8679.4	5203.5	-8.6	5194.9		
-30.00	1540.6	7034.0	8574.6	5140.6	-8.6	5132.0		
<hr/>								
283.S02	0.17	-8.00	2500.0	1257.4	3757.4	2252.6	-17.3	2235.3
		-8.50	1995.9	1377.2	3373.0	2022.2	-17.3	2004.9
		-9.00	1999.4	1487.4	3486.8	2090.4	-17.3	2073.1
		-9.50	1999.2	1581.0	3580.2	2146.4	-17.3	2129.1
		-10.00	1986.3	1686.1	3672.5	2201.7	-17.3	2184.4
		-10.50	1956.9	1787.6	3744.5	2244.9	-17.3	2227.6
		-11.00	1931.0	1886.8	3817.8	2288.8	-17.3	2271.5
		-11.50	1886.2	1993.3	3879.4	2325.8	-17.3	2308.5
		-12.00	2613.4	2061.5	4674.9	2802.7	-17.3	2785.3
		-12.50	2924.0	2179.9	5103.9	3059.9	-17.3	3042.5
		-13.00	3239.9	2311.5	5551.4	3328.2	-17.3	3310.8
		-13.50	3344.1	2458.1	5802.2	3478.5	-17.3	3461.2
		-14.00	3421.5	2632.1	6053.6	3629.3	-17.3	3611.9
		-14.50	3334.9	2806.2	6141.1	3681.7	-17.3	3664.4
		-15.00	3381.9	2961.6	6343.5	3803.1	-17.3	3785.7
		-15.50	3648.3	3094.6	6742.9	4042.5	-17.3	4025.2
		-16.00	4028.2	3240.4	7268.5	4357.6	-17.3	4340.3
		-16.50	4443.0	3402.7	7845.7	4703.7	-17.3	4686.3
		-17.00	4670.5	3576.6	8247.1	4944.3	-17.3	4927.0
		-17.50	4779.4	3759.0	8538.3	5118.9	-17.3	5101.6
		-18.00	4903.6	3941.3	8844.9	5302.7	-17.3	5285.4
		-18.50	5043.6	4123.7	9167.3	5496.0	-17.3	5478.6
		-19.00	5169.2	4306.1	9475.3	5680.6	-17.3	5663.3
		-19.50	5184.6	4488.4	9673.0	5799.2	-17.3	5781.8
		-20.00	5009.4	4670.8	9680.3	5803.5	-17.3	5786.2
		-20.50	5799.2	4845.0	10644.2	6381.4	-17.3	6364.1
		-21.00	5964.6	5027.4	10992.0	6589.9	-17.3	6572.6
		-21.50	6056.4	5209.8	11266.2	6754.3	-17.3	6737.0
		-22.00	6079.0	5392.1	11471.1	6877.2	-17.3	6859.8
		-22.50	6095.5	5574.5	11670.0	6996.4	-17.3	6979.1
		-23.00	4109.8	5756.9	9866.7	5915.3	-17.3	5898.0
-23.50	2766.9	5939.2	8706.1	5219.5	-17.3	5202.2		
-24.00	2367.6	6121.6	8489.2	5089.5	-17.3	5072.1		
-24.50	2055.8	6304.0	8359.8	5011.8	-17.3	4994.5		
-25.00	1820.6	6486.4	8306.9	4980.2	-17.3	4962.8		
-25.50	1433.1	6668.7	8101.8	4857.2	-17.3	4839.9		
-26.00	1201.2	6851.1	8052.3	4827.5	-17.3	4810.2		
-26.50	938.2	7043.1	7981.3	4785.0	-17.3	4767.6		
-27.00	858.5	7109.7	7968.2	4777.1	-17.3	4759.8		
-27.50	863.5	7172.9	8036.4	4818.0	-17.3	4800.6		
-28.00	855.7	7252.3	8108.0	4860.9	-17.3	4843.6		
-28.50	818.6	7353.0	8171.6	4899.1	-17.3	4881.7		
<hr/>								
19-1008_35	0.92	-8.00	2023.3	1267.1	3290.3	1972.6	-10.6	1962.0
		-8.50	1967.2	1359.1	3326.3	1994.2	-10.6	1983.6
		-9.00	2047.7	1429.4	3477.1	2084.6	-10.6	2073.9
		-9.50	2093.4	1500.2	3593.6	2154.4	-10.6	2143.8
		-10.00	2236.6	1585.8	3822.4	2291.6	-10.6	2281.0
		-10.50	2244.6	1666.0	3910.5	2344.5	-10.6	2333.8
		-11.00	2161.4	1803.9	3965.3	2377.3	-10.6	2366.6
		-11.50	2071.0	1921.4	3992.3	2393.5	-10.6	2382.8
		-12.00	2043.4	2002.6	4046.0	2425.7	-10.6	2415.0
		-12.50	2451.7	2072.8	4524.5	2712.5	-10.6	2701.9
		-13.00	2646.9	2166.4	4813.3	2885.7	-10.6	2875.0
		-13.50	2832.3	2276.9	5109.1	3063.0	-10.6	3052.4

Project : ZWO380 Funderingen
 Onderdeel : RLL-TBG380

Alle niveaus/hoogtes/peilmaten zijn t.o.v.: N.A.P.

sondering	maai niveau	veld niveau	Bezwijkdraagvermogen			Rekenwaarden		
			R _{b,real} [kN]	R _{s,real} [kN]	R _{c,real} [kN]	R _{b,d} [kN]	F _{bk,d} [kN]	R _{c,netto,d} [kN]
19-1008_35	0.92	-14.00	3041.8	2392.2	5434.1	3257.9	-10.6	3247.2
		-14.50	3068.2	2533.8	5602.0	3358.5	-10.6	3347.9
		-15.00	3103.3	2675.4	5778.7	3464.4	-10.6	3453.8
		-15.50	3131.0	2818.8	5949.8	3567.1	-10.6	3556.4
		-16.00	3103.8	2965.9	6069.7	3638.9	-10.6	3628.2
		-16.50	2932.0	3113.6	6045.6	3624.4	-10.6	3613.8
		-17.00	2988.6	3240.5	6229.1	3734.5	-10.6	3723.8
		-17.50	3303.5	3348.1	6651.6	3987.8	-10.6	3977.2
		-18.00	3447.8	3491.3	6939.0	4160.1	-10.6	4149.4
		-18.50	3604.2	3620.4	7224.6	4331.3	-10.6	4320.7
		-19.00	3632.7	3766.0	7398.7	4435.7	-10.6	4425.0
		-19.50	4001.9	3909.8	7911.7	4743.2	-10.6	4732.6
		-20.00	4434.1	4058.2	8492.2	5091.3	-10.6	5080.6
		-20.50	4462.0	4240.5	8702.6	5217.4	-10.6	5206.7
		-21.00	4529.9	4422.9	8952.8	5367.4	-10.6	5356.8
		-21.50	4804.9	4605.3	9410.2	5641.6	-10.6	5631.0
		-22.00	4915.9	4782.7	9698.6	5814.5	-10.6	5803.8
		-22.50	4171.3	4965.0	9136.4	5477.5	-10.6	5466.8
		-23.00	4114.3	5147.4	9261.7	5552.6	-10.6	5541.9
		-23.50	4118.3	5329.8	9448.1	5664.3	-10.6	5653.7
		-24.00	4082.6	5512.2	9594.8	5752.3	-10.6	5741.6
		-24.50	4041.8	5690.4	9732.2	5834.7	-10.6	5824.0
		-25.00	3952.6	5861.7	9814.3	5883.9	-10.6	5873.3
		-25.50	3513.3	6057.7	9571.0	5738.0	-10.6	5727.4
		-26.00	4076.2	6240.8	10316.9	6185.2	-10.6	6174.6
		-26.50	4771.9	6399.5	11171.4	6697.5	-10.6	6686.8
		-27.00	4956.5	6581.8	11538.3	6917.5	-10.6	6906.8
		-27.50	5033.4	6764.2	11797.5	7072.9	-10.6	7062.2
		-28.00	5022.7	6946.6	11969.2	7175.8	-10.6	7165.2
		-28.50	3153.3	7128.9	10282.2	6164.4	-10.6	6153.7
-29.00	2862.1	7311.3	10173.4	6099.2	-10.6	6088.5		
-29.50	2448.6	7493.7	9942.2	5960.6	-10.6	5949.9		
-30.00	2003.0	7676.0	9679.0	5802.8	-10.6	5792.1		
312.S03	3.78	-8.00	3022.7	1705.1	4727.8	2834.4	0.0	2834.4
		-8.50	3150.6	1887.5	5038.1	3020.4	0.0	3020.4
		-9.00	3312.7	2069.9	5382.6	3227.0	0.0	3227.0
		-9.50	3242.9	2252.2	5495.1	3294.4	0.0	3294.4
		-10.00	3221.5	2434.6	5656.1	3390.9	0.0	3390.9
		-10.50	3267.0	2614.8	5881.8	3526.3	0.0	3526.3
		-11.00	3377.3	2784.8	6162.1	3694.3	0.0	3694.3
		-11.50	3378.2	2967.2	6345.4	3804.2	0.0	3804.2
		-12.00	3555.2	3149.4	6704.6	4019.6	0.0	4019.6
		-12.50	3235.5	3331.8	6567.3	3937.2	0.0	3937.2
		-13.00	3501.0	3508.9	7009.9	4202.6	0.0	4202.6
		-13.50	3650.2	3637.5	7287.7	4369.1	0.0	4369.1
		-14.00	3560.3	3783.4	7343.7	4402.7	0.0	4402.7
		-14.50	3519.5	3929.3	7448.8	4465.7	0.0	4465.7
		-15.00	3517.0	4068.8	7585.9	4547.9	0.0	4547.9
		-15.50	3457.0	4214.7	7671.8	4599.4	0.0	4599.4
		-16.00	3463.5	4355.8	7819.4	4687.9	0.0	4687.9
		-16.50	3270.1	4501.7	7771.9	4659.4	0.0	4659.4
		-17.00	1832.2	4636.6	6468.7	3878.1	0.0	3878.1
		-17.50	1910.0	4742.0	6652.0	3988.0	0.0	3988.0
		-18.00	2008.7	4855.1	6863.8	4115.0	0.0	4115.0
		-18.50	2009.4	4997.1	7006.5	4200.5	0.0	4200.5
		-19.00	1998.4	5146.3	7144.7	4283.4	0.0	4283.4
		-19.50	1675.6	5301.1	6976.7	4182.7	0.0	4182.7
		-20.00	1752.0	5450.2	7202.2	4317.9	0.0	4317.9
		-20.50	2371.4	5580.7	7952.0	4767.4	0.0	4767.4
		-21.00	2762.6	5724.9	8487.5	5088.5	0.0	5088.5
		-21.50	3142.0	5858.8	9000.8	5396.2	0.0	5396.2
		-22.00	3324.2	6010.2	9334.4	5596.2	0.0	5596.2
		-22.50	3403.5	6188.1	9591.6	5750.3	0.0	5750.3
-23.00	3444.5	6367.2	9811.6	5882.3	0.0	5882.3		
-23.50	3686.7	6540.9	10227.6	6131.7	0.0	6131.7		
-24.00	2530.6	6700.2	9230.8	5534.0	0.0	5534.0		
-24.50	2255.7	6882.6	9138.3	5478.6	0.0	5478.6		
-25.00	1854.5	7064.9	8919.5	5347.4	0.0	5347.4		
-25.50	1629.5	7236.3	8865.7	5315.2	0.0	5315.2		
-26.00	1463.5	7389.2	8852.8	5307.4	0.0	5307.4		
-26.50	1326.2	7567.7	8893.9	5332.1	0.0	5332.1		
-27.00	1059.1	7746.1	8805.1	5278.8	0.0	5278.8		
-27.50	1015.7	7841.7	8857.4	5310.2	0.0	5310.2		
-28.00	993.1	7917.6	8910.7	5342.1	0.0	5342.1		
-28.50	990.3	7975.7	8966.0	5375.3	0.0	5375.3		
19-1008_43	9.88	-8.00	2894.8	1547.8	4442.6	2663.4	0.0	2663.4
		-8.50	2974.3	1679.9	4654.2	2790.3	0.0	2790.3
		-9.00	3035.7	1815.0	4850.7	2908.1	0.0	2908.1
		-9.50	3056.0	1953.3	5009.3	3003.2	0.0	3003.2
		-10.00	3548.2	2079.3	5627.5	3373.8	0.0	3373.8
		-10.50	3546.7	2231.1	5777.8	3463.9	0.0	3463.9
		-11.00	3527.3	2413.4	5940.8	3561.6	0.0	3561.6
		-11.50	3503.0	2595.8	6098.8	3656.3	0.0	3656.3
		-12.00	3518.0	2778.0	6296.0	3774.6	0.0	3774.6
		-12.50	3390.7	2958.9	6349.6	3806.7	0.0	3806.7
		-13.00	3413.1	3093.5	6506.5	3900.8	0.0	3900.8
		-13.50	3660.9	3209.3	6870.2	4118.8	0.0	4118.8
		-14.00	3683.0	3344.4	7027.5	4213.1	0.0	4213.1
		-14.50	3519.4	3490.3	7009.7	4202.5	0.0	4202.5
		-15.00	4013.7	3617.9	7631.6	4575.3	0.0	4575.3
-15.50	3499.4	3776.7	7276.1	4362.2	0.0	4362.2		
-16.00	3060.5	3952.0	7012.5	4204.1	0.0	4204.1		
-16.50	2804.5	4134.4	6938.9	4160.0	0.0	4160.0		
-17.00	2711.3	4316.8	7028.1	4213.5	0.0	4213.5		

Project : ZWO380 Funderingen
Onderdeel : RLL-TBG380

Alle niveaus/hoogtes/peilmaten zijn t.o.v.: N.A.P.

sondering	maaiveld niveau	paalpunt niveau	Bezwijkdraagvermogen			Rekenwaarden				
			$R_{b,real}$ [kN]	$R_{s,real}$ [kN]	$R_{c,real}$ [kN]	$R_{b;d}$ [kN]	$F_{b;k;d}$ [kN]	$R_{c,netto;d}$ [kN]		
19-1008_43	9.88	-17.50	2642.2	4492.4	7134.6	4277.4	0.0	4277.4		
		-18.00	2579.6	4651.4	7231.0	4335.1	0.0	4335.1		
		-18.50	2480.0	4793.7	7273.7	4360.7	0.0	4360.7		
		-19.00	2355.2	4936.3	7291.5	4371.4	0.0	4371.4		
		-19.50	2465.4	5051.5	7516.9	4506.5	0.0	4506.5		
		-20.00	2767.0	5170.5	7937.4	4758.6	0.0	4758.6		
		-20.50	2825.6	5320.7	8146.3	4883.9	0.0	4883.9		
		-21.00	3077.2	5495.1	8572.3	5139.2	0.0	5139.2		
		-21.50	4078.0	5639.2	9717.3	5825.7	0.0	5825.7		
		328.S02	10.17	-8.00	2313.0	2313.0	4626.0	2773.4	0.0	2773.4
				-8.50	2278.4	2456.5	4735.0	2838.7	0.0	2838.7
-9.00	2676.5			2596.6	5273.1	3161.3	0.0	3161.3		
-9.50	2880.6			2716.5	5597.1	3355.6	0.0	3355.6		
-10.00	3186.1			2851.7	6037.8	3619.8	0.0	3619.8		
-10.50	3377.1			2993.6	6370.8	3819.4	0.0	3819.4		
-11.00	3411.4			3156.8	6568.1	3937.7	0.0	3937.7		
-11.50	3473.1			3324.4	6797.5	4075.2	0.0	4075.2		
-12.00	3568.4			3486.4	7054.8	4229.5	0.0	4229.5		
-12.50	3097.1			3632.7	6729.8	4034.7	0.0	4034.7		
-13.00	3090.5			3775.5	6866.0	4116.3	0.0	4116.3		
-13.50	3107.3			3919.8	7027.1	4212.9	0.0	4212.9		
-14.00	3081.6			4065.7	7147.3	4285.0	0.0	4285.0		
-14.50	3095.8			4207.3	7303.0	4378.3	0.0	4378.3		
-15.00	2778.0			4354.7	7132.7	4276.2	0.0	4276.2		
-15.50	2843.6			4500.3	7343.9	4402.8	0.0	4402.8		
-16.00	3029.1			4644.8	7674.0	4600.7	0.0	4600.7		
-16.50	3203.6			4796.1	7999.7	4796.0	0.0	4796.0		
-17.00	3293.2			4978.5	8271.7	4959.0	0.0	4959.0		
-17.50	3172.1			5160.8	8332.9	4995.8	0.0	4995.8		
-18.00	2328.0			5370.1	7698.1	4615.2	0.0	4615.2		
-18.50	3693.9	5500.0	9193.8	5511.9	0.0	5511.9				
-19.00	3724.9	5663.2	9388.1	5628.4	0.0	5628.4				
-19.50	4062.5	5837.4	9899.9	5935.2	0.0	5935.2				
-20.00	4234.7	6019.7	10254.5	6147.8	0.0	6147.8				
-20.50	4597.6	6202.1	10799.7	6474.6	0.0	6474.6				
-21.00	4258.1	6384.4	10642.6	6380.4	0.0	6380.4				
-21.50	4381.3	6566.8	10948.1	6563.6	0.0	6563.6				
-22.00	4113.1	6749.2	10862.3	6512.2	0.0	6512.2				
-22.50	4221.0	6931.6	11152.5	6686.2	0.0	6686.2				
-23.00	4166.3	7113.9	11280.2	6762.7	0.0	6762.7				
-23.50	4217.2	7296.3	11513.5	6902.6	0.0	6902.6				
-24.00	4155.4	7478.7	11634.0	6974.8	0.0	6974.8				
-24.50	3869.0	7630.7	11499.7	6894.3	0.0	6894.3				
-25.00	3316.0	7776.6	11092.6	6650.2	0.0	6650.2				

PAALGEGEVENS SI Ø508/670

Type : In de grond gevormde geschroefde paal; groutinjectie
Wijze van installeren : Schroeven
Wijze van terugwinnen : n.v.t.
Diameter [m] : 0.590
Elasticiteitsmodulus [N/mm²] : 20000
Factor α_s (tabel 7.c EC 7.1) : 0.009 (zandlagen; voor kleilagen zie tabel 7.d)
Factor α_t (tabel 7.c EC 7.1) : 0.0090 (zandlagen; voor kleilagen zie tabel 7.d)
Paalklassefactor α_p : 0.63
Paalvoetvormfactor β : 1.00
Type lastzakingsdiagram : Grondverdringende paal
Verm.factor * $\varphi'_{j;k}$: 1.00
Groutomhulling : JA

PAALGEGEVENS SI Ø610/850

Type : In de grond gevormde geschroefde paal; groutinjectie
Wijze van installeren : Schroeven
Wijze van terugwinnen : n.v.t.
Diameter [m] : 0.730
Elasticiteitsmodulus [N/mm²] : 20000
Factor α_s (tabel 7.c EC 7.1) : 0.009 (zandlagen; voor kleilagen zie tabel 7.d)
Factor α_t (tabel 7.c EC 7.1) : 0.0090 (zandlagen; voor kleilagen zie tabel 7.d)
Paalklassefactor α_p : 0.63
Paalvoetvormfactor β : 1.00
Type lastzakingsdiagram : Grondverdringende paal
Verm.factor * $\varphi'_{j;k}$: 1.00
Groutomhulling : JA

PAALGEGEVENS SI Ø762/950

Type : In de grond gevormde geschroefde paal; groutinjectie
Wijze van installeren : Schroeven
Wijze van terugwinnen : n.v.t.
Diameter [m] : 0.860
Elasticiteitsmodulus [N/mm²] : 20000
Factor α_s (tabel 7.c EC 7.1) : 0.009 (zandlagen; voor kleilagen zie tabel 7.d)
Factor α_t (tabel 7.c EC 7.1) : 0.0090 (zandlagen; voor kleilagen zie tabel 7.d)
Paalklassefactor α_p : 0.63
Paalvoetvormfactor β : 1.00
Type lastzakingsdiagram : Grondverdringende paal
Verm.factor * $\varphi'_{j;k}$: 1.00
Groutomhulling : JA

Project : ZWO380 Funderingen
 Onderdeel : RLL-TBG380

OVERZICHT NETTO DRAAGVERMOGEN DRUKPALEN

Netto paal draagvermogen(s) zijn naar beneden toe afgerond op: 1.0 kN nauwkeurig
 Alle niveaus/hoogtes/peilmaten zijn t.o.v.: N.A.P.

sondering	maalveld niveau	paalpunt niveau	R _{d, netto, d} [kN]		
			SI Ø508/6	SI Ø610/8	SI Ø762/9
19-1008_1	2.12	-6.00	-71		
		-6.50	-70		
		-7.00	-66	-67	
		-7.50	-25	-9	
		-8.00	-13	8	34
		-8.50	-17	17	89
		-9.00	84	149	223
		-9.50	120	189	270
		-10.00	152	232	320
		-10.50	198	310	447
		-11.00	304	443	596
		-11.50	358	511	676
		-12.00	397	552	738
		-12.50	706	1013	1344
		-13.00	789	1115	1464
		-13.50	870	1258	1694
		-14.00	1055	1478	1924
		-14.50	1219	1731	2207
		-15.00	1320	1835	2371
		-15.50	1307	1789	2289
		-16.00	1481	2040	2618
		-16.50	1593	2198	2795
		-17.00	1802	2640	3590
		-17.50	2612	3099	3961
		-18.00	2308	3188	3621
		-18.50	2363	2898	3769
		-19.00	2077	2916	3778
		-19.50	2080	2887	3743
		-20.00	2080	2859	3681
		-20.50	2185	2992	3840
-21.00	2206	3114	4176		
-21.50	3011	4303	5815		
-22.00	3906	5554	7333		
-22.50	3981	5647	7442		
-23.00	4056	5740	7552		
-23.50	4131	5833	7661		
-24.00	4206	5926	7771		
-24.50	4281	6018	7880		
-25.00	4356	6111	7989		
-25.50	4431	6204	8099		
-26.00	4506	6297	8208		
-26.50	4581	6390	8317		
-27.00	4656	6482	8427		
-27.50	4731	6575	8536		
-28.00	4806	6668	8645		
-28.50	4881	6761	8755		
-29.00	4956	6854	8864		
-29.50	5031	6946			
-30.00	5106				
19-1008_6	11.00	-6.00	2214		
		-6.50	2342		
		-7.00	2412	3371	
		-7.50	2767	3881	
		-8.00	2995	4221	5504
		-8.50	3209	4465	5802
		-9.00	3320	4589	5933
		-9.50	3386	4714	6181
		-10.00	3811	5435	6752
		-10.50	3886	5510	6802
		-11.00	3961	5501	7035
		-11.50	4026	5629	7217
		-12.00	4091	5716	7374
		-12.50	4121	5751	7449
		-13.00	4149	5798	7512
		-13.50	4336	6086	7960
		-14.00	4411	6179	8069
		-14.50	4486	6272	7823
		-15.00	4561	6035	6375
		-15.50	4395	5032	6419
-16.00	3706	5018	6380		
-16.50	3764	5079	6446		
-17.00	3772	5070	6413		
-17.50	3781	5061	6381		
-18.00	3905	5497	7255		
-18.50	4606	6133	7834		
-19.00	4615	6248	7949		
-19.50	4717	6366	8079		
-20.00	4826	6494	8223		
-20.50	4926	6608			
-21.00	5057	6889			
-21.50	5497				
166.S01	3.45	-6.00	1435		
		-6.50	1619		
		-7.00	1721	2402	
		-7.50	1830	2529	
		-8.00	1954	2678	3437
		-8.50	2075	2836	3463
		-9.00	2181	2887	3600
		-9.50	2442	2991	3530

Project : ZWO380 Funderingen
 Onderdeel : RLL-TBG380

Netto paal draagvermogen(s) zijn naar beneden toe afgerond op: 1.0 kN nauwkeurig
 Alle niveaus/hoogtes/peilmaten zijn t.o.v.: N.A.P.

sondering	niveau	maalveld niveau	R _{n, netto;d} [kN]		
			SI Ø508/6	SI Ø610/8	SI Ø762/9
	-10.00	2244	2873	3635	
	-10.50	2235	2924	3770	
	-11.00	2170	3016	3876	
	-11.50	2171	2985	3831	
	-12.00	2178	2975	3812	
	-12.50	2224	3029	3871	
	-13.00	2336	3252	4286	
	-13.50	2644	3634	4717	
	-14.00	2754	3777	4855	
	-14.50	2865	3915	5017	
	-15.00	2968	4057	5250	
	-15.50	3248	4454	5701	
	-16.00	3390	4620	5837	
	-16.50	3510	4714	5930	
	-17.00	3596	4779	6068	
	-17.50	3653	4919	6233	
	-18.00	3758	5056	6394	
	-18.50	3842	5185	6544	
	-19.00	3899	5284	6652	
	-19.50	3938	5347		
	-20.00	4107			
19-1008_11	0.62	-6.00	-54		
		-6.50	-48		
		-7.00	32	105	
		-7.50	136	239	
		-8.00	171	279	402
		-8.50	201	314	440
		-9.00	234	354	440
		-9.50	269	355	490
		-10.00	269	400	546
		-10.50	295	432	582
		-11.00	328	474	632
		-11.50	346	491	645
		-12.00	321	455	618
		-12.50	722	1101	1537
		-13.00	1011	1342	1789
		-13.50	1018	1452	1917
		-14.00	1107	1561	2049
		-14.50	1189	1657	2155
		-15.00	1264	1742	2245
		-15.50	1345	1835	2380
		-16.00	1510	2062	2641
		-16.50	1592	2158	2748
		-17.00	1668	2251	2897
		-17.50	1931	2770	3654
		-18.00	2298	3231	4265
		-18.50	2424	3432	4407
		-19.00	2519	3546	4595
		-19.50	2585	3615	4708
		-20.00	2819	3761	4242
		-20.50	2748	3283	4178
		-21.00	2431	3352	4192
		-21.50	2452	3371	4269
		-22.00	2388	3242	4135
		-22.50	2400	3239	4110
		-23.00	2393	3221	4074
		-23.50	2579	3495	4415
		-24.00	2660	3581	4535
		-24.50	2705	3627	4580
		-25.00	2746	3690	4829
		-25.50	3413	4470	5712
		-26.00	3368	4566	5816
		-26.50	3439	4642	5892
		-27.00	3534	4755	6019
		-27.50	3654	4905	6198
		-28.00	3854	5270	6675
		-28.50	4066	5484	6940
		-29.00	4216	5846	7529
		-29.50	4771	6504	8297
		-30.00	4932	6706	8454
19-1008_12	3.57	-6.00	1757		
		-6.50	1419		
		-7.00	1376	1754	
		-7.50	1336	1722	
		-8.00	1291	1627	1871
		-8.50	1283	1577	1894
		-9.00	1262	1597	1919
		-9.50	1280	1622	1923
		-10.00	1294	1623	1946
		-10.50	1310	1651	1981
		-11.00	1301	1641	1983
		-11.50	1341	1691	2027
		-12.00	1354	1704	2038
		-12.50	1361	1714	2050
		-13.00	1381	1751	2122
		-13.50	1439	1833	2209
		-14.00	1473	1868	2251
		-14.50	1500	1899	2285
		-15.00	1525	1929	2320
		-15.50	1575	2021	2436
		-16.00	1628	2071	2501

Project : ZWO380 Funderingen
 Onderdeel : RLL-TBG380

Netto paal draagvermogen(s) zijn naar beneden toe afgerond op: 1.0 kN nauwkeurig
 Alle niveaus/hoogtes/peilmaten zijn t.o.v.: N.A.P.

sondering	maalveld niveau	paalpunt niveau	R _{n, netto;d} [kN]		
			SI Ø508/6	SI Ø610/8	SI Ø762/9
	-16.50	1666	2119	2561	
	-17.00	1712	2182	2636	
	-17.50	1748	2292	2826	
	-18.00	1953	2528	3097	
	-18.50	2032	2620	3219	
	-19.00	2289	3006	3718	
	-19.50	2424	3223	4107	
	-20.00	2650	3505	4371	
	-20.50	2651	3477	4312	
	-21.00	2933	3892	4860	
	-21.50	3060	4038	5031	
	-22.00	3189	4197	5218	
	-22.50	3274	4290	5146	
	-23.00	3488	4319	4872	
	-23.50	3418	4047	4882	
	-24.00	3155	4052	4892	
	-24.50	3119	3990	4726	
	-25.00	3102	3889	4757	
	-25.50	3052	3914	4768	
	-26.00	3118	3992	4851	
	-26.50	3176	4065	4937	
	-27.00	3227	4127	5010	
	-27.50	3267	4163	5071	
	-28.00	3621	4809	6054	
	-28.50	4017	5278		
	-29.00	4127			
19-1008_17	0.20	-6.00	-42		
		-6.50	0		
		-7.00	-50	-34	
		-7.50	-88	-87	
		-8.00	-78	-60	-30
		-8.50	-51	-32	-4
		-9.00	-48	-10	65
		-9.50	222	386	573
		-10.00	89	206	351
		-10.50	336	692	1161
		-11.00	994	1534	2105
		-11.50	1157	1698	1986
		-12.00	1297	1611	2189
		-12.50	1201	1755	2351
		-13.00	1268	1810	2396
		-13.50	1345	1893	2478
		-14.00	1431	1989	2579
		-14.50	1605	2295	3000
		-15.00	1801	2502	2233
		-15.50	1911	1856	2319
		-16.00	1448	1866	2421
		-16.50	1406	1950	2516
		-17.00	1494	2063	2663
		-17.50	1469	2003	2562
		-18.00	1465	1953	2481
		-18.50	1704	2357	2986
		-19.00	1865	2448	3126
		-19.50	1880	2552	3253
		-20.00	1971	2671	3402
		-20.50	2101	2850	3632
		-21.00	2081	2798	3494
		-21.50	2286	3154	3888
		-22.00	2531	3186	3955
		-22.50	2473	3245	4031
		-23.00	2477	3256	4024
		-23.50	2504	3274	4084
		-24.00	2541	3356	4171
		-24.50	2592	3413	4232
		-25.00	2653	3487	4326
		-25.50	2713	3561	4418
		-26.00	2785	3663	3567
		-26.50	2921	2996	3598
		-27.00	2385	3021	3669
		-27.50	2408	3078	3734
		-28.00	2448	3123	3781
		-28.50	2452	3110	3748
		-29.00	2401	3015	3600
		-29.50	2721	3656	4665
		-30.00	3140	4113	5110
19-1008_20	-0.03	-6.00	326		
		-6.50	476		
		-7.00	501	643	
		-7.50	557	580	
		-8.00	456	602	775
		-8.50	473	646	827
		-9.00	501	674	853
		-9.50	518	692	867
		-10.00	496	656	821
		-10.50	614	809	1005
		-11.00	612	819	1030
		-11.50	598	785	974
		-12.00	624	828	1036
		-12.50	651	860	1073
		-13.00	664	873	1084
		-13.50	729	974	1188

Project : ZWO380 Funderingen
 Onderdeel : RLL-TBG380

Netto paaldragvermogen(s) zijn naar beneden toe afgerond op: 1.0 kN nauwkeurig
 Alle niveaus/hoogtes/peilmaten zijn t.o.v.: N.A.P.

sondering	maalveld niveau	paalpunt niveau	R _{z, netto;d} [kN]		
			SI Ø508/6	SI Ø610/8	SI Ø762/9
	-14.00	761	979	1215	
	-14.50	772	1013	1259	
	-15.00	805	1052	1301	
	-15.50	829	1081	1334	
	-16.00	854	1114	1375	
	-16.50	871	1140	1403	
	-17.00	902	1186	1502	
	-17.50	1027	1361	1699	
	-18.00	1075	1424	1774	
	-18.50	1103	1475	1883	
	-19.00	1197	1583	1956	
	-19.50	1309	1669	2010	
	-20.00	1310	1665	2068	
	-20.50	1277	1658	2043	
	-21.00	1297	1671	2039	
	-21.50	1324	1701	2073	
	-22.00	1349	1733	2110	
	-22.50	1367	1769	2233	
	-23.00	1627	2148	2699	
	-23.50	1746	2310	2884	
	-24.00	1862	2471	3119	
	-24.50	1966	2602	3238	
	-25.00	2044	2694	3355	
	-25.50	2123	2790	3466	
	-26.00	2196	2907	3377	
	-26.50	2300	2817	3483	
	-27.00	2224	2896	3517	
	-27.50	2292	2940	3611	
	-28.00	2314	3017	3707	
	-28.50	2361	3097	3800	
	-29.00	2402	3161	3883	
	-29.50	2451	3224	3786	
	-30.00	2509	3138	3877	
19-1008_21	1.78	-6.00	669		
		-6.50	601		
		-7.00	617	863	
		-7.50	672	924	
		-8.00	721	995	1276
		-8.50	733	986	1245
		-9.00	756	1029	1316
		-9.50	870	1190	1508
		-10.00	900	1258	1593
		-10.50	945	1319	1693
		-11.00	976	1355	1757
		-11.50	1015	1403	1813
		-12.00	1043	1465	1759
		-12.50	1086	1441	1847
		-13.00	1119	1529	1958
		-13.50	1168	1589	1844
		-14.00	1196	1544	1840
		-14.50	1186	1576	1976
		-15.00	1177	1676	1913
		-15.50	1214	1592	1976
		-16.00	1232	1601	1970
		-16.50	1212	1549	1878
		-17.00	1235	1590	1949
		-17.50	1276	1703	2065
		-18.00	1357	1731	2099
		-18.50	1382	1764	2140
		-19.00	1413	1800	2178
		-19.50	1426	1817	2197
		-20.00	1440	1833	2216
		-20.50	1455	1852	2240
		-21.00	1476	1883	2280
		-21.50	1499	1913	2316
		-22.00	1523	1944	2354
		-22.50	1544	1972	2387
		-23.00	1565	1999	2422
		-23.50	1596	2042	2473
		-24.00	1624	2071	2512
		-24.50	1645	2101	2545
		-25.00	1670	2130	2581
		-25.50	1693	2161	2618
		-26.00	1717	2191	2652
		-26.50	1739	2221	2688
		-27.00	1761	2249	2721
		-27.50	1795	2295	2783
		-28.00	1820	2328	2825
		-28.50	1845	2359	2861
		-29.00	1876	2400	2914
		-29.50	1907	2440	2960
		-30.00	1934	2476	
251.S01	-1.05	-6.00	642		
		-6.50	547		
		-7.00	577	777	
		-7.50	574	754	
		-8.00	578	746	910
		-8.50	562	735	955
		-9.00	809	1136	1515
		-9.50	942	1268	1612
		-10.00	1000	1345	1702

Project : ZWO380 Funderingen
 Onderdeel : RLL-TBG380

Netto paal draagvermogen(s) zijn naar beneden toe afgerond op: 1.0 kN nauwkeurig
 Alle niveaus/hoogtes/peilmaten zijn t.o.v.: N.A.P.

sondering	maalveld paalpunt		R _{z, netto;d} [kN]		
	niveau	niveau	SI Ø508/6	SI Ø610/8	SI Ø762/9
	-10.50	1050	1397	1752	
	-11.00	1083	1427	1777	
	-11.50	1141	1502	1876	
	-12.00	1336	1784	1957	
	-12.50	1424	1641	2060	
	-13.00	1301	1727	2164	
	-13.50	1365	1808	2261	
	-14.00	1407	1858	2309	
	-14.50	1412	1854	2284	
	-15.00	1374	1816	2339	
	-15.50	1959	2704	3061	
	-16.00	2182	2533	3145	
	-16.50	1982	2595	3272	
	-17.00	2032	2711	3390	
	-17.50	2109	2780	3462	
	-18.00	2132	2789	2956	
	-18.50	2122	2489	2990	
	-19.00	2033	2533	2976	
	-19.50	1990	2508	2996	
	-20.00	1994	2503	3009	
	-20.50	1999	2528	3038	
	-21.00	2044	2572	3077	
	-21.50	2066	2596	3100	
	-22.00	2079	2612	3119	
	-22.50	2117	2698	3235	
	-23.00	2179	2747	3316	
	-23.50	2274	2887	3481	
	-24.00	2323	2946	3549	
	-24.50	2371	3024	3716	
	-25.00	2548	3262	3995	
	-25.50	2859	3712	4564	
	-26.00	3286	4578	5368	
	-26.50	3902	4481	5606	
	-27.00	3517	4619	5464	
	-27.50	3625	4608	5147	
	-28.00	3650	4253	5038	
	-28.50	3328	4132	4969	
	-29.00	3250	4106	4858	
	-29.50	3262	4066	4904	
	-30.00	3179	4027	4845	
19-1008_29	0.79	-6.00	1247		
		-6.50	1472		
		-7.00	1491	2032	
		-7.50	1547	2153	
		-8.00	1619	2244	2523
		-8.50	1684	2069	1822
		-9.00	1648	1520	1901
		-9.50	1219	1589	1977
		-10.00	1260	1656	2057
		-10.50	1292	1688	2102
		-11.00	1307	1694	2078
		-11.50	1274	1747	2190
		-12.00	1434	1818	2190
		-12.50	1444	1830	2222
		-13.00	1434	1819	2192
		-13.50	1463	1854	2233
		-14.00	1490	1887	2271
		-14.50	1514	1917	2305
		-15.00	1541	1902	2416
		-15.50	1607	2045	2471
		-16.00	1622	2051	2466
		-16.50	1647	2085	2506
		-17.00	1690	2194	2725
		-17.50	2088	2889	3694
		-18.00	2389	3199	4024
		-18.50	2411	3208	4024
		-19.00	2233	3087	4030
		-19.50	3057	4144	4590
		-20.00	3420	3787	4434
		-20.50	2966	3650	4370
		-21.00	2855	3552	4325
		-21.50	2709	3485	4238
		-22.00	2677	3429	4108
		-22.50	2608	3340	4050
		-23.00	2640	3376	4088
		-23.50	2732	3465	4213
		-24.00	2757	3537	4277
		-24.50	2790	3562	4296
		-25.00	2820	3591	4342
		-25.50	2868	3654	4420
		-26.00	2908	3695	4467
		-26.50	2941	3742	4523
		-27.00	2977	3784	4568
		-27.50	3024	3834	4628
		-28.00	3051	3876	4678
		-28.50	3088	3985	4772
		-29.00	3257	4351	5163
		-29.50	3412	4318	5194
		-30.00	3371	4271	5132
283.S02	0.17	-6.00	1011		
		-6.50	1081		

Project : ZWO380 Funderingen
 Onderdeel : RLL-TBG380

Netto paal draagvermogen(s) zijn naar beneden toe afgerond op: 1.0 kN nauwkeurig
 Alle niveaus/hoogtes/peilmaten zijn t.o.v.: N.A.P.

sondering	maalveld paalpunt		R _{z, netto;d} [kN]		
	niveau	niveau	SI Ø508/6	SI Ø610/8	SI Ø762/9
	-7.00	1112	1532		
	-7.50	1178	1673		
	-8.00	1252	1746	2235	
	-8.50	1298	1802	2004	
	-9.00	1334	1605	2073	
	-9.50	1201	1653	2129	
	-10.00	1242	1701	2184	
	-10.50	1275	1740	2227	
	-11.00	1309	1779	2271	
	-11.50	1306	1783	2308	
	-12.00	1550	2164	2785	
	-12.50	1688	2342	3042	
	-13.00	1830	2549	3310	
	-13.50	1978	2696	3461	
	-14.00	2071	2823	3611	
	-14.50	2127	2880	3664	
	-15.00	2165	2946	3785	
	-15.50	2354	3174	4025	
	-16.00	2506	3419	4340	
	-16.50	2675	3628	4686	
	-17.00	2947	4001	4926	
	-17.50	3053	4032	5101	
	-18.00	3054	4179	5285	
	-18.50	3154	4307	5478	
	-19.00	3254	4432	5663	
	-19.50	3337	4532	5781	
	-20.00	3324	4552	5786	
	-20.50	3530	4906	6364	
	-21.00	3780	5158	6572	
	-21.50	3879	5289	6736	
	-22.00	3959	5387	6859	
	-22.50	4042	5484	6979	
	-23.00	4149	5681	5897	
	-23.50	4432	4956	5202	
	-24.00	4214	4283	5072	
	-24.50	3328	4156	4994	
	-25.00	3261	4124	4962	
	-25.50	3180	4032	4839	
	-26.00	3179	4008	4810	
	-26.50	3149	3974	4767	
	-27.00	3187	4034	4759	
	-27.50	3228	4008	4800	
	-28.00	3221	4045	4843	
	-28.50	3243	4080	4881	
	-29.00	3268	4109		
	-29.50	3289			
19-1008_35	0.92	-6.00	931		
		-6.50	951		
		-7.00	979	1385	
		-7.50	1054	1475	
		-8.00	1085	1510	1961
		-8.50	1107	1533	1983
		-9.00	1143	1588	2073
		-9.50	1203	1660	2143
		-10.00	1238	1738	2280
		-10.50	1316	1811	2333
		-11.00	1350	1846	2366
		-11.50	1374	1867	2382
		-12.00	1399	1896	2415
		-12.50	1503	2095	2701
		-13.00	1639	2243	2875
		-13.50	1731	2370	3052
		-14.00	1919	2610	3247
		-14.50	1987	2616	3347
		-15.00	1991	2707	3453
		-15.50	2059	2793	3556
		-16.00	2117	2858	3628
		-16.50	2133	2861	3613
		-17.00	2175	2923	3723
		-17.50	2341	3147	3977
		-18.00	2383	3240	4149
		-18.50	2525	3423	4320
		-19.00	2589	3501	4425
		-19.50	2680	3659	4732
		-20.00	2932	3983	5080
		-20.50	3025	4093	5206
		-21.00	3124	4215	5356
		-21.50	3250	4481	5630
		-22.00	3544	4581	5803
		-22.50	3489	4701	5466
		-23.00	3572	4409	5541
		-23.50	3360	4475	5653
		-24.00	3412	4560	5741
		-24.50	3473	4632	5824
		-25.00	3518	4681	5873
		-25.50	3449	4569	5727
		-26.00	3673	4891	6174
		-26.50	3983	5319	6686
		-27.00	4119	5493	6906
		-27.50	4228	5627	7062
		-28.00	4312	5722	7165
		-28.50	4545	6006	6153

Project : ZWO380 Funderingen
 Onderdeel : RLL-TBG380

Netto paal draagvermogen(s) zijn naar beneden toe afgerond op: 1.0 kN nauwkeurig
 Alle niveaus/hoogtes/peilmaten zijn t.o.v.: N.A.P.

sondering	maalveld niveau	paalpunt niveau	R _{z, netto,z} [kN]		
			SI Ø508/6	SI Ø610/8	SI Ø762/9
		-29.00	4701	5096	6088
		-29.50	3968	4993	5949
		-30.00	3887	4864	5792
312.S03	3.78	-6.00	843		
		-6.50	861		
		-7.00	855	1128	
		-7.50	1010	1532	
		-8.00	1674	2177	2834
		-8.50	1685	2333	3020
		-9.00	1819	2505	3226
		-9.50	1890	2576	3294
		-10.00	2032	2758	3390
		-10.50	2244	2789	3526
		-11.00	2174	2921	3694
		-11.50	2286	3051	3804
		-12.00	2398	3198	4019
		-12.50	2393	3159	3937
		-13.00	2429	3330	4202
		-13.50	2596	3532	4369
		-14.00	2666	3602	4402
		-14.50	2690	3555	4465
		-15.00	2685	3589	4547
		-15.50	2733	3638	4599
		-16.00	2768	3712	4687
		-16.50	2774	3703	4659
		-17.00	2793	3717	3878
		-17.50	2864	3238	3988
		-18.00	2563	3338	4114
		-18.50	2622	3410	4200
		-19.00	2680	3482	4283
		-19.50	2653	3421	4182
		-20.00	2623	3442	4317
		-20.50	2967	3865	4767
		-21.00	3149	4115	5088
		-21.50	3269	4319	5396
		-22.00	3455	4521	5596
		-22.50	3573	4666	5750
		-23.00	3668	4774	5882
		-23.50	3756	4944	6131
		-24.00	3955	5177	5534
		-24.50	4047	4573	5478
		-25.00	3583	4520	5347
		-25.50	3571	4448	5315
		-26.00	3529	4444	5307
		-26.50	3524	4436	5332
		-27.00	3485	4400	5278
		-27.50	3511	4429	5310
		-28.00	3536	4458	5342
		-28.50	3559	4486	5375
		-29.00	3586	4562	
		-29.50	3650		
19-1008_43	9.88	-6.00	934		
		-6.50	1259		
		-7.00	1331	1862	
		-7.50	1405	1962	
		-8.00	1485	2063	2663
		-8.50	1563	2159	2790
		-9.00	1645	2260	2908
		-9.50	1716	2344	3003
		-10.00	1899	2659	3373
		-10.50	2053	2723	3463
		-11.00	2070	2793	3561
		-11.50	2127	2902	3656
		-12.00	2186	2997	3774
		-12.50	2201	3010	3806
		-13.00	2235	3054	3900
		-13.50	2354	3216	4118
		-14.00	2416	3294	4213
		-14.50	2428	3294	4202
		-15.00	2731	3732	4575
		-15.50	2812	3659	4362
		-16.00	2792	3554	4204
		-16.50	2773	3385	4160
		-17.00	2588	3369	4213
		-17.50	2594	3429	4277
		-18.00	2641	3481	4335
		-18.50	2671	3510	4360
		-19.00	2694	3529	4371
		-19.50	2763	3625	4506
		-20.00	2894	3827	4758
		-20.50	2993	3937	4883
		-21.00	3107	4120	5139
		-21.50	3414	4654	5825
		-22.00	3855	4777	
		-22.50	3660		
328.S02	10.17	-6.00	1386		
		-6.50	1350		
		-7.00	1478	1994	
		-7.50	1563	2102	
		-8.00	1641	2198	2773

Project : ZWO380 Funderingen
 Onderdeel : RLL-TBG380

Netto paal draagvermogen(s) zijn naar beneden toe afgerond op: 1.0 kN nauwkeurig
 Alle niveaus/hoogtes/peilmaten zijn t.o.v.: N.A.P.

sondering	maalveld paalpunt		R _{n, netto;d} [kN]		
	niveau	niveau	SI Ø508/6	SI Ø610/8	SI Ø762/9
	-8.50		1698	2261	2838
	-9.00		1824	2508	3161
	-9.50		1997	2671	3355
	-10.00		2160	2872	3619
	-10.50		2270	3038	3819
	-11.00		2355	3180	3937
	-11.50		2427	3251	4075
	-12.00		2492	3355	4229
	-12.50		2579	3464	4034
	-13.00		2673	3287	4116
	-13.50		2539	3349	4212
	-14.00		2564	3414	4284
	-14.50		2620	3493	4378
	-15.00		2658	3542	4276
	-15.50		2663	3518	4402
	-16.00		2765	3672	4600
	-16.50		2876	3824	4795
	-17.00		2976	3956	4959
	-17.50		3017	3996	4995
	-18.00		2773	3632	4615
	-18.50		3305	4395	5511
	-19.00		3395	4498	5628
	-19.50		3581	4745	5935
	-20.00		3715	4907	6147
	-20.50		3918	5184	6474
	-21.00		4050	5347	6380
	-21.50		4194	5279	6563
	-22.00		4137	5436	6512
	-22.50		4265	5385	6686
	-23.00		4215	5519	6762
	-23.50		4295	5589	6902
	-24.00		4306	5667	6974
	-24.50		4381	5786	6894
	-25.00		4372	5707	6650
	-25.50		4494	5501	
	-26.00		4291		
	-26.50		4402		

ALGEMENE GEGEVENS

Project : ZW0380 Funderingen
 Onderdeel : RLL-TBG380
 Datum : 27-03-2021
 Bestand : P:\EANL_Projects\10124719 - TenneT Engineering
 ZW380 kV Oost\2 Content\007 DO
 vakwerkmasten\TS Paalfunderingen\ZW0380
 steunmast DO.pvw
 Berekeningstype : Verticaal belaste paal
 Alle niveaus/hoogtes/peilmaten zijn t.o.v.: N.A.P.

Toegepaste normen volgens Eurocode met Nederlandse NB

Geotechniek EN 1997-1:2004 AC:2009
 NEN-EN 1997-1:2005 C1+A1:2013 NB:2016
 NEN 9997-1:2016 C2:2017

REKENGEDEVENS SI Ø508/670 trek

Berekening : Ontwerpend
 Rekenmethode : Trekpalen volgens NEN-EN 1997-1, art. 7.6.3
 Sondering(en) : 19-1008_1, 19-1008_6, 166.S01, 19-1008_11, 19-1008_12
 : 19-1008_17, 19-1008_20, 19-1008_21, 251.S01, 19-1008_29
 : 283.S02, 19-1008_35, 312.S03, 19-1008_43, 328.S02
 Let op: trekcapaciteit t.p.v. negatief kleefttraject is meegerkend.

Stijf bouwwerk : NEE
 Paalgroep : NEE
 Aantal sonderingen : 15
 Factor $\xi_{3(n=1)}$: 1.39 (handmatig)
 Factor $\xi_{3(gem)}$: 1.39 (handmatig)
 Factor $\xi_{4(min)}$: 1.39 (handmatig)
 Weerstandsfactor γ_R : 1.35
 $\gamma_{m;vakk}$: 1.50
 UGT draagvermogen zonder negatieve kleeft : NEE

Paal : SI Ø508/670
 Niveau paalkop [m] : N.A.P. 0.00
 Bovenbel. [kN/m²] : 0.00

PAALPUNTNIVEAUS SI Ø508/670

Alle niveaus/hoogtes/peilmaten zijn t.o.v. : N.A.P.

Nr	Beginniveau [m]	Eindniveau [m]	Stapgrootte [m]
1	-6.00	-30.00	0.50

RESULTATEN SI Ø508/670 trek (n=1)

Alle niveaus/hoogtes/peilmaten zijn t.o.v.: N.A.P.

Sondering	19-1008_1	19-1008_6	166.S01	19-1008_11	19-1008_12	19-1008_17
Niveau [m]	$F_{nettozt}$ [kN]	$F_{nettozt}$ [kN]	$F_{nettozt}$ [kN]	$F_{nettozt}$ [kN]	$F_{nettozt}$ [kN]	$F_{nettozt}$ [kN]
-6.00	46	393	231	159	419	68
-6.50	50	439	278	164	456	74
-7.00	53	485	324	169	501	99
-7.50	56	531	370	183	547	111
-8.00	68	577	416	202	593	116
-8.50	81	623	461	220	617	123
-9.00	86	669	507	234	625	134
-9.50	106	715	552	248	631	142
-10.00	124	761	598	262	643	177
-10.50	144	807	644	279	664	195
-11.00	159	854	690	298	681	224
-11.50	183	900	736	320	685	270
-12.00	214	946	779	348	701	317
-12.50	235	992	816	360	708	363
-13.00	268	1038	850	393	713	409
-13.50	300	1084	884	431	720	455
-14.00	329	1130	924	470	734	501
-14.50	366	1176	970	510	751	547
-15.00	400	1222	1016	549	764	590
-15.50	437	1268	1062	586	774	636
-16.00	469	1314	1108	618	791	682
-16.50	504	1360	1154	655	812	728
-17.00	539	1406	1200	690	830	772
-17.50	580	1452	1246	724	856	820
-18.00	626	1498	1292	766	877	875
-18.50	672	1542	1338	812	922	912
-19.00	719	1588	1384	858	964	945
-19.50	765	1634	1430	904	1002	982
-20.00	823	1680	1476	950	1035	1019
-20.50	881	1726	1522	996	1072	1059
-21.00	942	1772	1569	1042	1107	1100
-21.50	986	1818	1615	1086	1149	1146
-22.00	1032	1864	1661	1132	1195	1186
-22.50	1078	1910	1707	1178	1240	1232
-23.00	1124	1956	0	1220	1282	1278
-23.50	1170	2002	0	1249	1322	1324
-24.00	1216	0	0	1285	1365	1367
-24.50	1262	0	0	1326	1411	1404
-25.00	1308	0	0	1365	1457	1433
-25.50	1354	0	0	1398	1517	1462
-26.00	1400	0	0	1444	1578	1490
-26.50	1446	0	0	1490	1614	1517
-27.00	1492	0	0	1536	1647	1550
-27.50	1538	0	0	1582	1685	1585
-28.00	1584	0	0	1628	1713	1620
-28.50	1630	0	0	1675	1748	1658
-29.00	1676	0	0	1721	1794	1697

Project : ZWO380 Funderingen
 Onderdeel : RLL-TBG380

-29.50	1723	0	0	1767	1840	1709
-30.00	1769	0	0	1813	1886	1739

RESULTATEN SI Ø508/670 trek (n=1)

Alle niveaus/hoogtes/peilmaten zijn t.o.v.: N.A.P.

Niveau [m]	F _{nettozt} [kN]	F _{nettozt} [kN]	F _{nettozt} [kN]	F _{nettozt} [kN]	F _{nettozt} [kN]	F _{nettozt} [kN]
-6.00	86	154	185	278	225	245
-6.50	102	184	217	311	252	266
-7.00	131	214	254	349	285	283
-7.50	157	250	290	388	311	301
-8.00	177	284	323	431	336	325
-8.50	196	319	346	473	367	349
-9.00	223	338	351	509	396	368
-9.50	244	352	372	544	420	386
-10.00	269	373	404	576	447	409
-10.50	277	392	440	613	474	430
-11.00	309	413	469	650	500	465
-11.50	343	440	486	691	527	496
-12.00	351	469	504	712	545	517
-12.50	360	492	533	755	576	536
-13.00	375	519	567	788	610	560
-13.50	383	548	599	802	647	589
-14.00	397	590	643	819	691	618
-14.50	422	633	687	831	735	655
-15.00	450	664	734	842	775	691
-15.50	466	689	756	855	809	727
-16.00	479	734	798	885	846	765
-16.50	496	779	844	897	887	803
-17.00	508	787	890	909	931	835
-17.50	522	797	934	925	978	863
-18.00	547	815	975	964	1024	900
-18.50	575	863	1021	1010	1070	933
-19.00	597	897	1049	1056	1116	970
-19.50	627	907	1079	1091	1162	1007
-20.00	657	915	1116	1137	1208	1045
-20.50	695	923	1166	1183	1252	1091
-21.00	745	931	1218	1229	1298	1137
-21.50	768	941	1241	1275	1344	1183
-22.00	783	952	1249	1321	1390	1228
-22.50	800	964	1259	1374	1436	1274
-23.00	813	977	1275	1415	1482	1320
-23.50	838	989	1295	1443	1528	1366
-24.00	866	1003	1321	1475	1574	1412
-24.50	895	1018	1346	1509	1620	1457
-25.00	931	1033	1368	1544	1667	1501
-25.50	963	1049	1406	1566	1713	1550
-26.00	995	1064	1462	1592	1759	1597
-26.50	1023	1078	1516	1616	1808	1637
-27.00	1058	1093	1562	1645	1826	1683
-27.50	1089	1107	1608	1668	1843	1729
-28.00	1117	1122	1654	1690	1864	1776
-28.50	1149	1137	1700	1713	1890	1822
-29.00	1180	1152	1747	1737	1909	1868
-29.50	1204	1168	1778	1774	1926	1914
-30.00	1235	1185	1816	1807	1942	1960

Project : ZWO380 Funderingen
 Onderdeel : RLL-TBG380

RESULTATEN SI Ø508/670 trek (n=1)

Alle niveaus/hoogtes/peilmaten zijn t.o.v.: N.A.P.

Sondering 312.S03 19-1008_43 328.S02

Niveau [m]	F _{netto:st} [kN]	F _{netto:st} [kN]	F _{netto:st} [kN]
-6.00	291	225	371
-6.50	326	244	408
-7.00	368	280	434
-7.50	393	315	467
-8.00	421	351	503
-8.50	467	385	539
-9.00	513	420	575
-9.50	559	455	606
-10.00	605	487	641
-10.50	651	526	677
-11.00	695	572	718
-11.50	741	618	761
-12.00	787	664	802
-12.50	833	710	839
-13.00	878	745	876
-13.50	911	774	913
-14.00	948	809	950
-14.50	985	846	986
-15.00	1021	879	1024
-15.50	1059	919	1061
-16.00	1095	964	1097
-16.50	1132	1010	1136
-17.00	1167	1056	1182
-17.50	1194	1100	1228
-18.00	1223	1141	1281
-18.50	1259	1177	1314
-19.00	1298	1213	1356
-19.50	1337	1243	1400
-20.00	1375	1274	1446
-20.50	1409	1312	1492
-21.00	1445	1356	1538
-21.50	1480	1393	1584
-22.00	1518	1434	1630
-22.50	1563	1480	1676
-23.00	1609	1526	1722
-23.50	1653	1573	1769
-24.00	1693	1619	1815
-24.50	1739	1665	1854
-25.00	1785	1704	1891
-25.50	1829	0	1928
-26.00	1868	0	1965
-26.50	1913	0	2004
-27.00	1958	0	2050
-27.50	1983	0	2096
-28.00	2003	0	2135
-28.50	2019	0	2170
-29.00	2035	0	0
-29.50	2052	0	0
-30.00	2076	0	0

Project : ZWO380 Funderingen
 Onderdeel : RLL-TBG380

SAMENVATTINGSTABEL SI Ø508/670 trek (n=1)
Uitgangspunten

- paal : SI Ø508/670
 - paaltype : In de grond gevormde geschroefde paal; groutinjectie
 - schachtafmeting : 590 mm
 Paalklassefactor α_p : 0.63
 Factor α_s (tabel 7.c EC 7.1) : 0.0090 (zandlagen; voor kleilagen zie tabel 7.d)
 Correlatiefactor $\xi_{s(n=1)}$: 1.39

Alle niveaus/hoogtes/peilmaten zijn t.o.v.: N.A.P.

sondering	maaiveld paalpunt		Rekenwaarden		
	niveau	niveau	Bewijkdraagvermogen $R_{t,calc}$ [kN]	$R_{t,d}$ [kN]	$R_{t,netto,d}$ [kN]
19-1008_1	2.12	-6.00	46.3	46.3	46.3
		-6.50	49.6	49.6	49.6
		-7.00	52.9	52.9	52.9
		-7.50	56.4	56.4	56.4
		-8.00	67.8	67.8	67.8
		-8.50	80.6	80.6	80.6
		-9.00	85.5	85.5	85.5
		-9.50	105.6	105.6	105.6
		-10.00	123.5	123.5	123.5
		-10.50	144.3	144.3	144.3
		-11.00	159.0	159.0	159.0
		-11.50	183.2	183.2	183.2
		-12.00	213.9	213.9	213.9
		-12.50	234.9	234.9	234.9
		-13.00	267.7	267.7	267.7
		-13.50	300.5	300.5	300.5
		-14.00	328.9	328.9	328.9
		-14.50	365.9	365.9	365.9
		-15.00	400.0	400.0	400.0
		-15.50	436.9	436.9	436.9
		-16.00	468.7	468.7	468.7
		-16.50	503.7	503.7	503.7
		-17.00	539.1	539.1	539.1
		-17.50	580.4	580.4	580.4
		-18.00	626.4	626.4	626.4
		-18.50	672.5	672.5	672.5
		-19.00	718.5	718.5	718.5
		-19.50	764.6	764.6	764.6
		-20.00	822.5	822.5	822.5
		-20.50	881.2	881.2	881.2
		-21.00	942.1	942.1	942.1
-21.50	985.5	985.5	985.5		
-22.00	1031.6	1031.6	1031.6		
-22.50	1077.7	1077.7	1077.7		
-23.00	1123.7	1123.7	1123.7		
-23.50	1169.8	1169.8	1169.8		
-24.00	1215.8	1215.8	1215.8		
-24.50	1261.9	1261.9	1261.9		
-25.00	1308.0	1308.0	1308.0		
-25.50	1354.0	1354.0	1354.0		
-26.00	1400.1	1400.1	1400.1		
-26.50	1446.2	1446.2	1446.2		
-27.00	1492.2	1492.2	1492.2		
-27.50	1538.3	1538.3	1538.3		
-28.00	1584.4	1584.4	1584.4		
-28.50	1630.4	1630.4	1630.4		
-29.00	1676.5	1676.5	1676.5		
-29.50	1722.6	1722.6	1722.6		
-30.00	1768.6	1768.6	1768.6		
19-1008_6	11.00	-6.00	392.7	392.7	392.7
		-6.50	439.0	439.0	439.0
		-7.00	485.0	485.0	485.0
		-7.50	531.1	531.1	531.1
		-8.00	577.1	577.1	577.1
		-8.50	623.2	623.2	623.2
		-9.00	669.3	669.3	669.3
		-9.50	715.3	715.3	715.3
		-10.00	761.4	761.4	761.4
		-10.50	807.5	807.5	807.5
		-11.00	853.5	853.5	853.5
		-11.50	899.6	899.6	899.6
		-12.00	945.7	945.7	945.7
		-12.50	991.7	991.7	991.7
		-13.00	1037.8	1037.8	1037.8
		-13.50	1083.9	1083.9	1083.9
		-14.00	1129.9	1129.9	1129.9
		-14.50	1176.0	1176.0	1176.0
		-15.00	1222.1	1222.1	1222.1
		-15.50	1268.1	1268.1	1268.1
		-16.00	1314.2	1314.2	1314.2
		-16.50	1360.3	1360.3	1360.3
		-17.00	1406.3	1406.3	1406.3
-17.50	1452.4	1452.4	1452.4		
-18.00	1498.4	1498.4	1498.4		
-18.50	1541.6	1541.6	1541.6		
-19.00	1587.6	1587.6	1587.6		
-19.50	1633.7	1633.7	1633.7		
-20.00	1679.8	1679.8	1679.8		
-20.50	1725.8	1725.8	1725.8		
-21.00	1771.9	1771.9	1771.9		
-21.50	1818.0	1818.0	1818.0		
-22.00	1864.0	1864.0	1864.0		
-22.50	1910.1	1910.1	1910.1		
-23.00	1956.1	1956.1	1956.1		

Project : ZWO380 Funderingen
 Onderdeel : RLL-TBG380

Alle niveaus/hoogtes/peilmaten zijn t.o.v.: N.A.P.

sondering	maai veld paalpunt		Bezuikdraagvermogen	Rekenwaarden		
	niveau	niveau		$R_{t,ca1}$ [kN]	$R_{t,d}$ [kN]	$R_{t,netto,d}$ [kN]
19-1008_6	11.00	-23.50	2002.2	2002.2	2002.2	
166.S01	3.45	-6.00	231.5	231.5	231.5	
		-6.50	277.5	277.5	277.5	
		-7.00	323.6	323.6	323.6	
		-7.50	369.7	369.7	369.7	
		-8.00	415.7	415.7	415.7	
		-8.50	461.5	461.5	461.5	
		-9.00	507.2	507.2	507.2	
		-9.50	552.2	552.2	552.2	
		-10.00	598.3	598.3	598.3	
		-10.50	644.3	644.3	644.3	
		-11.00	690.4	690.4	690.4	
		-11.50	736.5	736.5	736.5	
		-12.00	779.3	779.3	779.3	
		-12.50	815.5	815.5	815.5	
		-13.00	849.6	849.6	849.6	
		-13.50	884.1	884.1	884.1	
		-14.00	923.8	923.8	923.8	
		-14.50	969.7	969.7	969.7	
		-15.00	1015.7	1015.7	1015.7	
		-15.50	1061.8	1061.8	1061.8	
		-16.00	1107.9	1107.9	1107.9	
-16.50	1153.9	1153.9	1153.9			
-17.00	1200.0	1200.0	1200.0			
-17.50	1246.1	1246.1	1246.1			
-18.00	1292.1	1292.1	1292.1			
-18.50	1338.2	1338.2	1338.2			
-19.00	1384.3	1384.3	1384.3			
-19.50	1430.3	1430.3	1430.3			
-20.00	1476.4	1476.4	1476.4			
-20.50	1522.5	1522.5	1522.5			
-21.00	1568.5	1568.5	1568.5			
-21.50	1614.6	1614.6	1614.6			
-22.00	1660.7	1660.7	1660.7			
-22.50	1706.7	1706.7	1706.7			
19-1008_11	0.62	-6.00	159.1	159.1	159.1	
		-6.50	163.7	163.7	163.7	
		-7.00	169.1	169.1	169.1	
		-7.50	182.8	182.8	182.8	
		-8.00	202.3	202.3	202.3	
		-8.50	220.1	220.1	220.1	
		-9.00	234.3	234.3	234.3	
		-9.50	247.9	247.9	247.9	
		-10.00	262.0	262.0	262.0	
		-10.50	278.5	278.5	278.5	
		-11.00	297.6	297.6	297.6	
		-11.50	320.1	320.1	320.1	
		-12.00	348.2	348.2	348.2	
		-12.50	359.6	359.6	359.6	
		-13.00	392.6	392.6	392.6	
		-13.50	431.0	431.0	431.0	
		-14.00	470.0	470.0	470.0	
		-14.50	509.5	509.5	509.5	
		-15.00	549.0	549.0	549.0	
		-15.50	586.2	586.2	586.2	
		-16.00	617.7	617.7	617.7	
		-16.50	654.6	654.6	654.6	
		-17.00	690.2	690.2	690.2	
		-17.50	723.9	723.9	723.9	
		-18.00	765.9	765.9	765.9	
		-18.50	812.0	812.0	812.0	
		-19.00	858.1	858.1	858.1	
		-19.50	904.1	904.1	904.1	
		-20.00	950.2	950.2	950.2	
		-20.50	996.3	996.3	996.3	
		-21.00	1042.3	1042.3	1042.3	
-21.50	1085.9	1085.9	1085.9			
-22.00	1132.0	1132.0	1132.0			
-22.50	1178.0	1178.0	1178.0			
-23.00	1220.2	1220.2	1220.2			
-23.50	1248.6	1248.6	1248.6			
-24.00	1284.8	1284.8	1284.8			
-24.50	1325.5	1325.5	1325.5			
-25.00	1364.5	1364.5	1364.5			
-25.50	1397.5	1397.5	1397.5			
-26.00	1444.2	1444.2	1444.2			
-26.50	1490.3	1490.3	1490.3			
-27.00	1536.3	1536.3	1536.3			
-27.50	1582.4	1582.4	1582.4			
-28.00	1628.4	1628.4	1628.4			
-28.50	1674.5	1674.5	1674.5			
-29.00	1720.6	1720.6	1720.6			
-29.50	1766.6	1766.6	1766.6			
-30.00	1812.7	1812.7	1812.7			
19-1008_12	3.57	-6.00	419.1	419.1	419.1	
		-6.50	455.7	455.7	455.7	
		-7.00	500.7	500.7	500.7	
		-7.50	546.8	546.8	546.8	
		-8.00	592.5	592.5	592.5	
		-8.50	616.8	616.8	616.8	
		-9.00	625.0	625.0	625.0	
		-9.50	631.5	631.5	631.5	
		-10.00	642.7	642.7	642.7	
		-10.50	663.9	663.9	663.9	

Project : ZWO380 Funderingen
 Onderdeel : RLL-TBG380

Alle niveaus/hoogtes/peilmaten zijn t.o.v.: N.A.P.

sondering	maai- veld niveau	paalpunt niveau	Bezwijkdraagvermogen		
			$R_{t,caal}$ [kN]	$R_{t,d}$ [kN]	$R_{t,netto,d}$ [kN]
19-1008_12	3.57	-11.00	680.6	680.6	680.6
		-11.50	685.2	685.2	685.2
		-12.00	700.9	700.9	700.9
		-12.50	707.6	707.6	707.6
		-13.00	713.3	713.3	713.3
		-13.50	719.8	719.8	719.8
		-14.00	733.7	733.7	733.7
		-14.50	751.3	751.3	751.3
		-15.00	764.0	764.0	764.0
		-15.50	774.5	774.5	774.5
		-16.00	790.6	790.6	790.6
		-16.50	811.9	811.9	811.9
		-17.00	829.9	829.9	829.9
		-17.50	856.0	856.0	856.0
		-18.00	876.5	876.5	876.5
		-18.50	921.9	921.9	921.9
		-19.00	963.6	963.6	963.6
		-19.50	1001.9	1001.9	1001.9
		-20.00	1035.1	1035.1	1035.1
		-20.50	1072.3	1072.3	1072.3
		-21.00	1107.2	1107.2	1107.2
		-21.50	1149.3	1149.3	1149.3
		-22.00	1194.7	1194.7	1194.7
		-22.50	1240.1	1240.1	1240.1
		-23.00	1281.9	1281.9	1281.9
		-23.50	1322.1	1322.1	1322.1
		-24.00	1364.9	1364.9	1364.9
		-24.50	1411.0	1411.0	1411.0
		-25.00	1457.1	1457.1	1457.1
		-25.50	1517.3	1517.3	1517.3
-26.00	1578.0	1578.0	1578.0		
-26.50	1613.6	1613.6	1613.6		
-27.00	1646.9	1646.9	1646.9		
-27.50	1684.9	1684.9	1684.9		
-28.00	1712.9	1712.9	1712.9		
-28.50	1748.3	1748.3	1748.3		
-29.00	1794.4	1794.4	1794.4		
-29.50	1840.5	1840.5	1840.5		
-30.00	1885.7	1885.7	1885.7		
19-1008_17	0.20	-6.00	68.1	68.1	68.1
		-6.50	73.8	73.8	73.8
		-7.00	99.0	99.0	99.0
		-7.50	110.8	110.8	110.8
		-8.00	116.4	116.4	116.4
		-8.50	122.9	122.9	122.9
		-9.00	133.9	133.9	133.9
		-9.50	142.5	142.5	142.5
		-10.00	176.9	176.9	176.9
		-10.50	194.7	194.7	194.7
		-11.00	224.4	224.4	224.4
		-11.50	270.5	270.5	270.5
		-12.00	316.5	316.5	316.5
		-12.50	362.6	362.6	362.6
		-13.00	408.7	408.7	408.7
		-13.50	454.7	454.7	454.7
		-14.00	500.8	500.8	500.8
		-14.50	546.8	546.8	546.8
		-15.00	589.6	589.6	589.6
		-15.50	635.7	635.7	635.7
		-16.00	681.7	681.7	681.7
		-16.50	727.8	727.8	727.8
		-17.00	772.1	772.1	772.1
		-17.50	819.7	819.7	819.7
		-18.00	874.7	874.7	874.7
		-18.50	912.1	912.1	912.1
		-19.00	944.6	944.6	944.6
		-19.50	981.8	981.8	981.8
		-20.00	1019.4	1019.4	1019.4
		-20.50	1059.1	1059.1	1059.1
-21.00	1100.0	1100.0	1100.0		
-21.50	1146.2	1146.2	1146.2		
-22.00	1185.9	1185.9	1185.9		
-22.50	1231.9	1231.9	1231.9		
-23.00	1278.0	1278.0	1278.0		
-23.50	1324.0	1324.0	1324.0		
-24.00	1366.9	1366.9	1366.9		
-24.50	1404.0	1404.0	1404.0		
-25.00	1433.3	1433.3	1433.3		
-25.50	1461.8	1461.8	1461.8		
-26.00	1489.6	1489.6	1489.6		
-26.50	1517.3	1517.3	1517.3		
-27.00	1549.9	1549.9	1549.9		
-27.50	1584.8	1584.8	1584.8		
-28.00	1620.4	1620.4	1620.4		
-28.50	1657.6	1657.6	1657.6		
-29.00	1696.6	1696.6	1696.6		
-29.50	1708.7	1708.7	1708.7		
-30.00	1738.7	1738.7	1738.7		
19-1008_20	-0.03	-6.00	86.3	86.3	86.3
		-6.50	102.3	102.3	102.3
		-7.00	131.3	131.3	131.3
		-7.50	156.7	156.7	156.7
		-8.00	176.7	176.7	176.7
		-8.50	196.3	196.3	196.3

Project : ZWO380 Funderingen
 Onderdeel : RLL-TBG380

Alle niveaus/hoogtes/peilmaten zijn t.o.v.: N.A.P.

sondering	maaiveld paalpunt		Bezwijkdraagvermogen		
	niveau	niveau	$R_{t,ca1}$ [kN]	$R_{t,d}$ [kN]	$R_{t,netto,d}$ [kN]
19-1008_20	-0.03	-9.00	222.8	222.8	222.8
		-9.50	244.5	244.5	244.5
		-10.00	269.4	269.4	269.4
		-10.50	276.5	276.5	276.5
		-11.00	308.5	308.5	308.5
		-11.50	342.8	342.8	342.8
		-12.00	350.7	350.7	350.7
		-12.50	359.6	359.6	359.6
		-13.00	375.3	375.3	375.3
		-13.50	383.2	383.2	383.2
		-14.00	397.2	397.2	397.2
		-14.50	421.7	421.7	421.7
		-15.00	449.6	449.6	449.6
		-15.50	465.9	465.9	465.9
		-16.00	478.6	478.6	478.6
		-16.50	495.8	495.8	495.8
		-17.00	507.6	507.6	507.6
		-17.50	521.6	521.6	521.6
		-18.00	546.6	546.6	546.6
		-18.50	575.5	575.5	575.5
		-19.00	597.5	597.5	597.5
		-19.50	626.6	626.6	626.6
		-20.00	656.7	656.7	656.7
		-20.50	694.8	694.8	694.8
		-21.00	745.4	745.4	745.4
		-21.50	767.7	767.7	767.7
		-22.00	783.0	783.0	783.0
		-22.50	799.5	799.5	799.5
		-23.00	813.1	813.1	813.1
		-23.50	838.2	838.2	838.2
-24.00	866.0	866.0	866.0		
-24.50	895.1	895.1	895.1		
-25.00	930.6	930.6	930.6		
-25.50	963.0	963.0	963.0		
-26.00	994.7	994.7	994.7		
-26.50	1023.4	1023.4	1023.4		
-27.00	1058.3	1058.3	1058.3		
-27.50	1089.0	1089.0	1089.0		
-28.00	1117.0	1117.0	1117.0		
-28.50	1149.4	1149.4	1149.4		
-29.00	1179.6	1179.6	1179.6		
-29.50	1204.3	1204.3	1204.3		
-30.00	1234.9	1234.9	1234.9		
19-1008_21	1.78	-6.00	153.6	153.6	153.6
		-6.50	183.6	183.6	183.6
		-7.00	213.5	213.5	213.5
		-7.50	250.0	250.0	250.0
		-8.00	284.3	284.3	284.3
		-8.50	319.0	319.0	319.0
		-9.00	337.7	337.7	337.7
		-9.50	352.1	352.1	352.1
		-10.00	373.3	373.3	373.3
		-10.50	392.0	392.0	392.0
		-11.00	413.3	413.3	413.3
		-11.50	439.8	439.8	439.8
		-12.00	469.3	469.3	469.3
		-12.50	492.3	492.3	492.3
		-13.00	518.7	518.7	518.7
		-13.50	547.7	547.7	547.7
		-14.00	590.1	590.1	590.1
		-14.50	632.6	632.6	632.6
		-15.00	664.1	664.1	664.1
		-15.50	689.1	689.1	689.1
		-16.00	733.7	733.7	733.7
		-16.50	778.5	778.5	778.5
		-17.00	787.3	787.3	787.3
		-17.50	797.2	797.2	797.2
		-18.00	814.8	814.8	814.8
		-18.50	863.5	863.5	863.5
		-19.00	897.3	897.3	897.3
		-19.50	907.1	907.1	907.1
		-20.00	915.2	915.2	915.2
		-20.50	923.3	923.3	923.3
-21.00	931.4	931.4	931.4		
-21.50	940.9	940.9	940.9		
-22.00	951.6	951.6	951.6		
-22.50	964.3	964.3	964.3		
-23.00	976.9	976.9	976.9		
-23.50	989.1	989.1	989.1		
-24.00	1003.3	1003.3	1003.3		
-24.50	1017.9	1017.9	1017.9		
-25.00	1033.1	1033.1	1033.1		
-25.50	1049.0	1049.0	1049.0		
-26.00	1064.2	1064.2	1064.2		
-26.50	1078.2	1078.2	1078.2		
-27.00	1092.5	1092.5	1092.5		
-27.50	1106.6	1106.6	1106.6		
-28.00	1121.7	1121.7	1121.7		
-28.50	1137.2	1137.2	1137.2		
-29.00	1152.2	1152.2	1152.2		
-29.50	1168.0	1168.0	1168.0		
-30.00	1184.7	1184.7	1184.7		

Project : ZWO380 Funderingen
Onderdeel : RLL-TBG380

Alle niveaus/hoogtes/peilmaten zijn t.o.v.: N.A.P.

sondering	maaiveld paalpunt		Bewijkdraagvermogen		
	niveau	niveau	R _{t,caal} [kN]	R _{t,d} [kN]	R _{t,netto,d} [kN]
251.S01	-1.05	-6.00	184.5	184.5	184.5
		-6.50	216.7	216.7	216.7
		-7.00	253.9	253.9	253.9
		-7.50	290.0	290.0	290.0
		-8.00	323.2	323.2	323.2
		-8.50	346.1	346.1	346.1
		-9.00	350.9	350.9	350.9
		-9.50	372.2	372.2	372.2
		-10.00	403.6	403.6	403.6
		-10.50	440.3	440.3	440.3
		-11.00	468.6	468.6	468.6
		-11.50	486.4	486.4	486.4
		-12.00	504.0	504.0	504.0
		-12.50	533.0	533.0	533.0
		-13.00	566.9	566.9	566.9
		-13.50	599.0	599.0	599.0
		-14.00	642.9	642.9	642.9
		-14.50	686.6	686.6	686.6
		-15.00	733.7	733.7	733.7
		-15.50	755.7	755.7	755.7
		-16.00	798.4	798.4	798.4
		-16.50	844.5	844.5	844.5
		-17.00	890.1	890.1	890.1
		-17.50	933.7	933.7	933.7
		-18.00	975.0	975.0	975.0
		-18.50	1021.0	1021.0	1021.0
		-19.00	1049.3	1049.3	1049.3
		-19.50	1079.4	1079.4	1079.4
		-20.00	1115.6	1115.6	1115.6
		-20.50	1165.6	1165.6	1165.6
-21.00	1218.1	1218.1	1218.1		
-21.50	1240.9	1240.9	1240.9		
-22.00	1249.1	1249.1	1249.1		
-22.50	1259.5	1259.5	1259.5		
-23.00	1275.1	1275.1	1275.1		
-23.50	1295.0	1295.0	1295.0		
-24.00	1321.5	1321.5	1321.5		
-24.50	1345.7	1345.7	1345.7		
-25.00	1367.8	1367.8	1367.8		
-25.50	1406.2	1406.2	1406.2		
-26.00	1461.8	1461.8	1461.8		
-26.50	1516.2	1516.2	1516.2		
-27.00	1562.3	1562.3	1562.3		
-27.50	1608.4	1608.4	1608.4		
-28.00	1654.4	1654.4	1654.4		
-28.50	1700.5	1700.5	1700.5		
-29.00	1746.6	1746.6	1746.6		
-29.50	1778.3	1778.3	1778.3		
-30.00	1815.5	1815.5	1815.5		
19-1008_29	0.79	-6.00	277.7	277.7	277.7
		-6.50	310.9	310.9	310.9
		-7.00	348.9	348.9	348.9
		-7.50	388.4	388.4	388.4
		-8.00	430.6	430.6	430.6
		-8.50	472.6	472.6	472.6
		-9.00	509.3	509.3	509.3
		-9.50	543.7	543.7	543.7
		-10.00	576.0	576.0	576.0
		-10.50	613.2	613.2	613.2
		-11.00	650.2	650.2	650.2
		-11.50	691.4	691.4	691.4
		-12.00	711.5	711.5	711.5
		-12.50	754.5	754.5	754.5
		-13.00	787.7	787.7	787.7
		-13.50	802.3	802.3	802.3
		-14.00	819.3	819.3	819.3
		-14.50	831.5	831.5	831.5
		-15.00	842.2	842.2	842.2
		-15.50	854.7	854.7	854.7
		-16.00	884.9	884.9	884.9
-16.50	896.8	896.8	896.8		
-17.00	908.8	908.8	908.8		
-17.50	925.5	925.5	925.5		
-18.00	964.1	964.1	964.1		
-18.50	1010.2	1010.2	1010.2		
-19.00	1055.7	1055.7	1055.7		
-19.50	1090.7	1090.7	1090.7		
-20.00	1136.8	1136.8	1136.8		
-20.50	1182.9	1182.9	1182.9		
-21.00	1228.9	1228.9	1228.9		
-21.50	1275.0	1275.0	1275.0		
-22.00	1321.1	1321.1	1321.1		
-22.50	1374.2	1374.2	1374.2		
-23.00	1414.8	1414.8	1414.8		
-23.50	1442.8	1442.8	1442.8		
-24.00	1475.5	1475.5	1475.5		
-24.50	1508.7	1508.7	1508.7		
-25.00	1543.8	1543.8	1543.8		
-25.50	1566.3	1566.3	1566.3		
-26.00	1591.8	1591.8	1591.8		
-26.50	1615.8	1615.8	1615.8		
-27.00	1645.4	1645.4	1645.4		
-27.50	1668.2	1668.2	1668.2		
-28.00	1690.5	1690.5	1690.5		
-28.50	1712.6	1712.6	1712.6		

Project : ZWO380 Funderingen
 Onderdeel : RLL-TBG380

Alle niveaus/hoogtes/peilmaten zijn t.o.v.: N.A.P.

sondering	maaiveld niveau	paalpunt niveau	Bezwijkdraagvermogen		
			$R_{t,caal}$ [kN]	$R_{t,d}$ [kN]	$R_{t,netto,d}$ [kN]
19-1008_29	0.79	-29.00	1736.8	1736.8	1736.8
		-29.50	1774.1	1774.1	1774.1
		-30.00	1806.7	1806.7	1806.7
283.S02	0.17	-6.00	225.0	225.0	225.0
		-6.50	252.2	252.2	252.2
		-7.00	284.9	284.9	284.9
		-7.50	310.9	310.9	310.9
		-8.00	336.5	336.5	336.5
		-8.50	367.3	367.3	367.3
		-9.00	395.8	395.8	395.8
		-9.50	420.2	420.2	420.2
		-10.00	447.5	447.5	447.5
		-10.50	473.8	473.8	473.8
		-11.00	499.6	499.6	499.6
		-11.50	527.2	527.2	527.2
		-12.00	545.4	545.4	545.4
		-12.50	575.9	575.9	575.9
		-13.00	609.7	609.7	609.7
		-13.50	647.2	647.2	647.2
		-14.00	691.2	691.2	691.2
		-14.50	735.2	735.2	735.2
		-15.00	774.9	774.9	774.9
		-15.50	808.9	808.9	808.9
		-16.00	846.1	846.1	846.1
		-16.50	887.4	887.4	887.4
		-17.00	931.4	931.4	931.4
		-17.50	977.5	977.5	977.5
		-18.00	1023.6	1023.6	1023.6
		-18.50	1069.6	1069.6	1069.6
		-19.00	1115.7	1115.7	1115.7
		-19.50	1161.8	1161.8	1161.8
		-20.00	1207.8	1207.8	1207.8
		-20.50	1252.0	1252.0	1252.0
		-21.00	1298.0	1298.0	1298.0
		-21.50	1344.1	1344.1	1344.1
		-22.00	1390.2	1390.2	1390.2
		-22.50	1436.2	1436.2	1436.2
		-23.00	1482.3	1482.3	1482.3
		-23.50	1528.4	1528.4	1528.4
-24.00	1574.4	1574.4	1574.4		
-24.50	1620.5	1620.5	1620.5		
-25.00	1666.6	1666.6	1666.6		
-25.50	1712.6	1712.6	1712.6		
-26.00	1758.7	1758.7	1758.7		
-26.50	1808.1	1808.1	1808.1		
-27.00	1826.0	1826.0	1826.0		
-27.50	1843.0	1843.0	1843.0		
-28.00	1864.0	1864.0	1864.0		
-28.50	1890.1	1890.1	1890.1		
-29.00	1909.3	1909.3	1909.3		
-29.50	1926.3	1926.3	1926.3		
-30.00	1942.2	1942.2	1942.2		
19-1008_35	0.92	-6.00	245.4	245.4	245.4
		-6.50	266.1	266.1	266.1
		-7.00	283.4	283.4	283.4
		-7.50	301.0	301.0	301.0
		-8.00	324.8	324.8	324.8
		-8.50	348.9	348.9	348.9
		-9.00	367.6	367.6	367.6
		-9.50	386.5	386.5	386.5
		-10.00	409.0	409.0	409.0
		-10.50	430.1	430.1	430.1
		-11.00	465.4	465.4	465.4
		-11.50	495.6	495.6	495.6
		-12.00	517.1	517.1	517.1
		-12.50	535.8	535.8	535.8
		-13.00	560.2	560.2	560.2
		-13.50	588.8	588.8	588.8
		-14.00	618.5	618.5	618.5
		-14.50	654.6	654.6	654.6
		-15.00	690.8	690.8	690.8
		-15.50	727.5	727.5	727.5
		-16.00	765.0	765.0	765.0
		-16.50	802.6	802.6	802.6
		-17.00	835.2	835.2	835.2
		-17.50	863.0	863.0	863.0
		-18.00	899.6	899.6	899.6
		-18.50	932.8	932.8	932.8
-19.00	969.9	969.9	969.9		
-19.50	1006.7	1006.7	1006.7		
-20.00	1044.6	1044.6	1044.6		
-20.50	1090.8	1090.8	1090.8		
-21.00	1136.9	1136.9	1136.9		
-21.50	1182.9	1182.9	1182.9		
-22.00	1227.9	1227.9	1227.9		
-22.50	1274.0	1274.0	1274.0		
-23.00	1320.1	1320.1	1320.1		
-23.50	1366.1	1366.1	1366.1		
-24.00	1412.2	1412.2	1412.2		
-24.50	1457.4	1457.4	1457.4		
-25.00	1501.0	1501.0	1501.0		
-25.50	1550.4	1550.4	1550.4		
-26.00	1596.7	1596.7	1596.7		
-26.50	1637.3	1637.3	1637.3		

Project : ZWO380 Funderingen
 Onderdeel : RLL-TBG380

Alle niveaus/hoogtes/peilmaten zijn t.o.v.: N.A.P.

sondering	maaiveld niveau	paalpunt niveau	Bezwijkdraagvermogen		
			R _{z,ca1} [kN]	R _{z,d} [kN]	R _{z,netto,zd} [kN]
19-1008_35	0.92	-27.00	1683.4	1683.4	1683.4
		-27.50	1729.5	1729.5	1729.5
		-28.00	1775.5	1775.5	1775.5
		-28.50	1821.6	1821.6	1821.6
		-29.00	1867.7	1867.7	1867.7
		-29.50	1913.7	1913.7	1913.7
		-30.00	1959.8	1959.8	1959.8
312.S03	3.78	-6.00	291.0	291.0	291.0
		-6.50	326.4	326.4	326.4
		-7.00	367.5	367.5	367.5
		-7.50	393.1	393.1	393.1
		-8.00	421.1	421.1	421.1
		-8.50	467.1	467.1	467.1
		-9.00	513.2	513.2	513.2
		-9.50	559.3	559.3	559.3
		-10.00	605.3	605.3	605.3
		-10.50	651.2	651.2	651.2
		-11.00	694.9	694.9	694.9
		-11.50	740.9	740.9	740.9
		-12.00	787.0	787.0	787.0
		-12.50	833.1	833.1	833.1
		-13.00	877.9	877.9	877.9
		-13.50	911.1	911.1	911.1
		-14.00	948.3	948.3	948.3
		-14.50	985.5	985.5	985.5
		-15.00	1021.5	1021.5	1021.5
		-15.50	1058.6	1058.6	1058.6
		-16.00	1094.9	1094.9	1094.9
		-16.50	1132.0	1132.0	1132.0
		-17.00	1166.5	1166.5	1166.5
		-17.50	1193.8	1193.8	1193.8
		-18.00	1223.0	1223.0	1223.0
		-18.50	1259.3	1259.3	1259.3
		-19.00	1297.5	1297.5	1297.5
		-19.50	1336.9	1336.9	1336.9
		-20.00	1375.0	1375.0	1375.0
		-20.50	1408.6	1408.6	1408.6
-21.00	1445.4	1445.4	1445.4		
-21.50	1479.7	1479.7	1479.7		
-22.00	1518.3	1518.3	1518.3		
-22.50	1563.3	1563.3	1563.3		
-23.00	1608.6	1608.6	1608.6		
-23.50	1652.6	1652.6	1652.6		
-24.00	1693.2	1693.2	1693.2		
-24.50	1739.2	1739.2	1739.2		
-25.00	1785.3	1785.3	1785.3		
-25.50	1828.7	1828.7	1828.7		
-26.00	1867.6	1867.6	1867.6		
-26.50	1912.7	1912.7	1912.7		
-27.00	1957.8	1957.8	1957.8		
-27.50	1983.2	1983.2	1983.2		
-28.00	2003.3	2003.3	2003.3		
-28.50	2019.1	2019.1	2019.1		
-29.00	2034.7	2034.7	2034.7		
-29.50	2052.5	2052.5	2052.5		
-30.00	2076.2	2076.2	2076.2		
19-1008_43	9.88	-6.00	224.5	224.5	224.5
		-6.50	244.3	244.3	244.3
		-7.00	280.5	280.5	280.5
		-7.50	315.3	315.3	315.3
		-8.00	351.4	351.4	351.4
		-8.50	385.2	385.2	385.2
		-9.00	419.8	419.8	419.8
		-9.50	455.1	455.1	455.1
		-10.00	487.5	487.5	487.5
		-10.50	526.2	526.2	526.2
		-11.00	572.3	572.3	572.3
		-11.50	618.3	618.3	618.3
		-12.00	664.4	664.4	664.4
		-12.50	710.1	710.1	710.1
		-13.00	744.5	744.5	744.5
		-13.50	774.4	774.4	774.4
		-14.00	809.0	809.0	809.0
		-14.50	846.1	846.1	846.1
		-15.00	878.9	878.9	878.9
		-15.50	919.3	919.3	919.3
		-16.00	963.6	963.6	963.6
		-16.50	1009.7	1009.7	1009.7
		-17.00	1055.8	1055.8	1055.8
		-17.50	1100.2	1100.2	1100.2
-18.00	1140.6	1140.6	1140.6		
-18.50	1176.9	1176.9	1176.9		
-19.00	1213.2	1213.2	1213.2		
-19.50	1242.9	1242.9	1242.9		
-20.00	1273.5	1273.5	1273.5		
-20.50	1311.8	1311.8	1311.8		
-21.00	1356.1	1356.1	1356.1		
-21.50	1392.8	1392.8	1392.8		
-22.00	1434.3	1434.3	1434.3		
-22.50	1480.4	1480.4	1480.4		
-23.00	1526.4	1526.4	1526.4		
-23.50	1572.5	1572.5	1572.5		
-24.00	1618.6	1618.6	1618.6		
-24.50	1664.6	1664.6	1664.6		

Project : ZWO380 Funderingen
Onderdeel : RLL-TBG380

Alle niveaus/hoogtes/peilmaten zijn t.o.v.: N.A.P.

sondering	maaiveld paalpunt		Bewijkdraagvermogen	Rekenwaarden		
	niveau	niveau		$R_{t,ca1}$ [kN]	$R_{t,d}$ [kN]	$R_{t,netto,d}$ [kN]
19-1008_43	9.88	-25.00	1703.7	1703.7	1703.7	
328.S02	10.17	-6.00	371.0	371.0	371.0	
		-6.50	408.2	408.2	408.2	
		-7.00	434.2	434.2	434.2	
		-7.50	466.8	466.8	466.8	
		-8.00	502.5	502.5	502.5	
		-8.50	539.3	539.3	539.3	
		-9.00	575.0	575.0	575.0	
		-9.50	605.9	605.9	605.9	
		-10.00	640.7	640.7	640.7	
		-10.50	677.0	677.0	677.0	
		-11.00	718.4	718.4	718.4	
		-11.50	760.8	760.8	760.8	
		-12.00	802.0	802.0	802.0	
		-12.50	839.3	839.3	839.3	
		-13.00	875.7	875.7	875.7	
		-13.50	912.6	912.6	912.6	
		-14.00	949.8	949.8	949.8	
		-14.50	986.0	986.0	986.0	
		-15.00	1023.5	1023.5	1023.5	
		-15.50	1060.7	1060.7	1060.7	
		-16.00	1097.5	1097.5	1097.5	
		-16.50	1136.0	1136.0	1136.0	
		-17.00	1182.1	1182.1	1182.1	
		-17.50	1228.1	1228.1	1228.1	
		-18.00	1280.8	1280.8	1280.8	
		-18.50	1314.2	1314.2	1314.2	
		-19.00	1355.8	1355.8	1355.8	
		-19.50	1400.0	1400.0	1400.0	
		-20.00	1446.1	1446.1	1446.1	
		-20.50	1492.2	1492.2	1492.2	
		-21.00	1538.2	1538.2	1538.2	
		-21.50	1584.3	1584.3	1584.3	
		-22.00	1630.4	1630.4	1630.4	
		-22.50	1676.4	1676.4	1676.4	
		-23.00	1722.5	1722.5	1722.5	
		-23.50	1768.6	1768.6	1768.6	
		-24.00	1814.6	1814.6	1814.6	
		-24.50	1853.8	1853.8	1853.8	
		-25.00	1891.0	1891.0	1891.0	
		-25.50	1927.6	1927.6	1927.6	
		-26.00	1964.8	1964.8	1964.8	
		-26.50	2004.2	2004.2	2004.2	
		-27.00	2050.2	2050.2	2050.2	
		-27.50	2096.3	2096.3	2096.3	
		-28.00	2135.4	2135.4	2135.4	
		-28.50	2169.6	2169.6	2169.6	

REKENGEGEVENS SI Ø610/850 trek

Berekening : Ontwerpend
Rekenmethode : Trekpalen volgens NEN-EN 1997-1, art. 7.6.3
Sondering(en) : 19-1008_1, 19-1008_6, 166.S01, 19-1008_11, 19-1008_12
: 19-1008_17, 19-1008_20, 19-1008_21, 251.S01, 19-1008_29
: 283.S02, 19-1008_35, 312.S03, 19-1008_43, 328.S02

Let op: trekcapaciteit t.p.v. negatief kleefttraject is meegerekend.

Stijf bouwwerk : NEE
Paalgroep : NEE
Aantal sonderingen : 15
Factor $\xi_3 (n=1)$: 1.39 (handmatig)
Factor $\xi_3 (g=0)$: 1.39 (handmatig)
Factor $\xi_3 (min)$: 1.39 (handmatig)
Weerstandsfactor γ_R : 1.35
 $\gamma_{m,verleg}$: 1.50
UGT draagvermogen zonder negatieve kleeft : NEE

Paal : SI Ø610/850
Niveau paalkop [m] : N.A.P. 0.00
Bovenbel. [kN/m²] : 0.00

PAALPUNTNIVEAUS SI Ø610/850

Alle niveaus/hoogtes/peilmaten zijn t.o.v. : N.A.P.

Nr	Beginniveau [m]	Eindniveau [m]	Stapgrootte [m]
1	-7.00	-30.00	0.50

Project : ZWO380 Funderingen
 Onderdeel : RLL-TBG380

RESULTATEN SI Ø610/850 trek (n=1)

Alle niveaus/hoogtes/peilmaten zijn t.o.v.: N.A.P.

Sondering	19-1008_1	19-1008_6	166.S01	19-1008_11	19-1008_12	19-1008_17
Niveau	F _{netto:tt}	F _{netto:tt}	F _{netto:tt}	F _{netto:tt}	F _{netto:tt}	F _{netto:tt}
[m]	[kN]	[kN]	[kN]	[kN]	[kN]	[kN]
-7.00	72	607	407	216	626	130
-7.50	77	664	464	234	684	145
-8.00	92	722	522	258	741	152
-8.50	108	779	579	281	771	161
-9.00	114	837	636	299	782	175
-9.50	140	894	692	316	790	186
-10.00	162	952	750	334	805	229
-10.50	189	1009	807	355	831	251
-11.00	207	1067	865	379	853	289
-11.50	238	1124	922	407	859	346
-12.00	276	1181	976	442	879	404
-12.50	302	1239	1021	457	887	461
-13.00	344	1296	1064	498	895	519
-13.50	385	1354	1107	546	903	576
-14.00	420	1411	1156	595	921	634
-14.50	466	1469	1214	644	943	691
-15.00	509	1526	1271	694	960	744
-15.50	555	1584	1328	740	973	802
-16.00	595	1641	1386	780	993	859
-16.50	639	1699	1443	826	1020	917
-17.00	683	1756	1501	870	1043	972
-17.50	735	1814	1558	913	1076	1031
-18.00	792	1871	1616	965	1102	1100
-18.50	850	1925	1673	1023	1158	1147
-19.00	907	1982	1731	1080	1210	1187
-19.50	965	2040	1788	1137	1258	1234
-20.00	1037	2097	1846	1195	1300	1281
-20.50	1110	2155	1903	1252	1346	1330
-21.00	1186	2212	1961	1310	1390	1382
-21.50	1240	2270	2018	1364	1442	1439
-22.00	1297	2327	2076	1422	1499	1489
-22.50	1355	2385	2133	1479	1556	1546
-23.00	1412	2442	0	1532	1608	1604
-23.50	1470	2500	0	1568	1658	1661
-24.00	1527	0	0	1613	1712	1715
-24.50	1585	0	0	1664	1769	1761
-25.00	1642	0	0	1712	1827	1798
-25.50	1700	0	0	1754	1902	1833
-26.00	1757	0	0	1812	1977	1868
-26.50	1814	0	0	1869	2022	1903
-27.00	1872	0	0	1927	2063	1944
-27.50	1929	0	0	1984	2111	1988
-28.00	1987	0	0	2042	2146	2032
-28.50	2044	0	0	2099	2190	2079
-29.00	2102	0	0	2157	2248	2127
-29.50	2159	0	0	2214	2305	2143
-30.00	2217	0	0	2272	2362	2180

Project : ZWO380 Funderingen
 Onderdeel : RLL-TBG380

RESULTATEN SI Ø610/850 trek (n=1)

Alle niveaus/hoogtes/peilmaten zijn t.o.v.: N.A.P.

Niveau	19-1008_20	19-1008_21	251.S01	19-1008_29	283.S02	19-1008_35
[m]	F _{netto:rt} [kN]	F _{netto:rt} [kN]	F _{netto:rt} [kN]	F _{netto:rt} [kN]	F _{netto:rt} [kN]	F _{netto:rt} [kN]
-7.00	170	271	322	438	360	357
-7.50	202	316	368	488	392	380
-8.00	227	359	409	541	425	410
-8.50	252	403	438	593	463	440
-9.00	285	426	444	639	499	463
-9.50	312	445	471	682	530	487
-10.00	344	471	510	722	564	516
-10.50	353	495	556	769	597	542
-11.00	393	522	592	815	629	586
-11.50	436	555	614	867	664	624
-12.00	446	592	637	892	687	651
-12.50	458	621	673	946	725	675
-13.00	477	654	715	987	767	706
-13.50	488	690	756	1006	814	741
-14.00	506	743	810	1027	869	779
-14.50	536	796	865	1043	924	824
-15.00	571	836	924	1056	974	869
-15.50	592	867	951	1072	1016	915
-16.00	608	923	1005	1110	1063	962
-16.50	<u>630</u>	979	1062	1125	1114	1009
-17.00	<u>645</u>	990	1119	1141	1169	1050
-17.50	<u>663</u>	1003	1174	1162	1227	1084
-18.00	<u>694</u>	1025	1225	1210	1284	1130
-18.50	<u>730</u>	1086	1282	1268	1342	1172
-19.00	<u>758</u>	1128	1318	1324	1399	1218
-19.50	<u>795</u>	1141	1356	1368	1457	1264
-20.00	<u>832</u>	1151	1401	1426	1514	1312
-20.50	<u>880</u>	1162	1463	1483	1569	1369
-21.00	<u>943</u>	1172	1529	1541	1627	1427
-21.50	<u>971</u>	1185	1557	1598	1684	1484
-22.00	<u>990</u>	1198	1568	1656	1742	1540
-22.50	<u>1011</u>	1214	1581	1722	1799	1598
-23.00	1029	1231	1601	1773	1857	1655
-23.50	1060	1246	1626	1808	1914	1713
-24.00	1095	1264	1659	1849	1971	1770
-24.50	1132	1283	1690	1890	2029	1827
-25.00	1176	1302	1718	1934	2086	1881
-25.50	1216	1322	1766	1962	2144	1943
-26.00	1256	1341	1835	1994	2201	2000
-26.50	1292	1359	1903	2024	2263	2051
-27.00	1336	1377	1960	2062	2286	2109
-27.50	1374	1395	2018	2090	2307	2166
-28.00	1409	1414	2075	2118	2333	2223
-28.50	1450	1434	2133	2146	2366	2281
-29.00	1488	1453	2190	2177	2390	2338
-29.50	1519	1473	2230	2223	2412	2396
-30.00	1557	1494	2276	2264	2432	2453

Project : ZWO380 Funderingen
 Onderdeel : RLL-TBG380

RESULTATEN SI Ø610/850 trek (n=1)

Alle niveaus/hoogtes/peilmaten zijn t.o.v.: N.A.P.

Sondering 312.S03 19-1008_43 328.S02

Niveau [m]	F _{netto:st} [kN]	F _{netto:st} [kN]	F _{netto:st} [kN]
-7.00	461	354	544
-7.50	494	397	585
-8.00	529	442	629
-8.50	586	485	675
-9.00	644	528	720
-9.50	701	572	759
-10.00	758	613	802
-10.50	816	661	848
-11.00	870	719	899
-11.50	928	776	952
-12.00	985	833	1004
-12.50	1043	890	1050
-13.00	1099	934	1096
-13.50	1140	971	1142
-14.00	1187	1014	1188
-14.50	1233	1061	1234
-15.00	1278	1102	1281
-15.50	1325	1152	1327
-16.00	1370	1207	1373
-16.50	1416	1265	1421
-17.00	1459	1322	1479
-17.50	1494	1378	1536
-18.00	1530	1428	1602
-18.50	1576	1474	1644
-19.00	1623	1519	1696
-19.50	1673	1556	1751
-20.00	1720	1595	1808
-20.50	1762	1642	1866
-21.00	1808	1698	1923
-21.50	1851	1744	1981
-22.00	1899	1796	2038
-22.50	1956	1853	2096
-23.00	2012	1910	2153
-23.50	2067	1968	2211
-24.00	2118	2025	2268
-24.50	2175	2083	2317
-25.00	2233	2132	2363
-25.50	2287	0	2409
-26.00	2335	0	2456
-26.50	2392	0	2505
-27.00	2448	0	2562
-27.50	2480	0	2620
-28.00	2505	0	2669
-28.50	2525	0	2711
-29.00	2545	0	0
-29.50	2568	0	0
-30.00	2597	0	0

Project : ZWO380 Funderingen
Onderdeel : RLL-TBG380

SAMENVATTINGSTABEL SI Ø610/850 trek (n=1)**Uitgangspunten**

- paal : SI Ø610/850
- paaltype : In de grond gevormde geschroefde paal; groutinjectie
- schachtafmeting : 730 mm
Paalklassefactor α_p : 0.63
Factor α_s (tabel 7.c EC 7.1) : 0.0090 (zandlagen; voor kleilagen zie tabel 7.d)
Correlatiefactor $\xi_{s(n=1)}$: 1.39

Alle niveaus/hoogtes/peilmaten zijn t.o.v.: N.A.P.

sondering	maaiveld paalpunt		Bewijkdraagvermogen		
	niveau	niveau	$R_{t,calc}$ [kN]	$R_{t,d}$ [kN]	$R_{t,netto,d}$ [kN]
19-1008_1	2.12	-7.00	72.1	72.1	72.1
		-7.50	76.9	76.9	76.9
		-8.00	91.5	91.5	91.5
		-8.50	107.7	107.7	107.7
		-9.00	114.4	114.4	114.4
		-9.50	139.6	139.6	139.6
		-10.00	162.3	162.3	162.3
		-10.50	188.5	188.5	188.5
		-11.00	207.1	207.1	207.1
		-11.50	237.6	237.6	237.6
		-12.00	276.1	276.1	276.1
		-12.50	302.5	302.5	302.5
		-13.00	343.6	343.6	343.6
		-13.50	384.6	384.6	384.6
		-14.00	420.2	420.2	420.2
		-14.50	466.5	466.5	466.5
		-15.00	509.1	509.1	509.1
		-15.50	555.3	555.3	555.3
		-16.00	595.1	595.1	595.1
		-16.50	638.8	638.8	638.8
		-17.00	683.2	683.2	683.2
		-17.50	734.7	734.7	734.7
		-18.00	792.1	792.1	792.1
		-18.50	849.6	849.6	849.6
		-19.00	907.1	907.1	907.1
		-19.50	964.5	964.5	964.5
		-20.00	1036.7	1036.7	1036.7
		-20.50	1109.8	1109.8	1109.8
		-21.00	1185.6	1185.6	1185.6
		-21.50	1239.8	1239.8	1239.8
		-22.00	1297.2	1297.2	1297.2
-22.50	1354.7	1354.7	1354.7		
-23.00	1412.2	1412.2	1412.2		
-23.50	1469.7	1469.7	1469.7		
-24.00	1527.1	1527.1	1527.1		
-24.50	1584.6	1584.6	1584.6		
-25.00	1642.1	1642.1	1642.1		
-25.50	1699.5	1699.5	1699.5		
-26.00	1757.0	1757.0	1757.0		
-26.50	1814.5	1814.5	1814.5		
-27.00	1871.9	1871.9	1871.9		
-27.50	1929.4	1929.4	1929.4		
-28.00	1986.9	1986.9	1986.9		
-28.50	2044.4	2044.4	2044.4		
-29.00	2101.8	2101.8	2101.8		
-29.50	2159.3	2159.3	2159.3		
-30.00	2216.8	2216.8	2216.8		
19-1008_6	11.00	-7.00	606.7	606.7	606.7
		-7.50	664.2	664.2	664.2
		-8.00	721.7	721.7	721.7
		-8.50	779.2	779.2	779.2
		-9.00	836.6	836.6	836.6
		-9.50	894.1	894.1	894.1
		-10.00	951.6	951.6	951.6
		-10.50	1009.0	1009.0	1009.0
		-11.00	1066.5	1066.5	1066.5
		-11.50	1124.0	1124.0	1124.0
		-12.00	1181.4	1181.4	1181.4
		-12.50	1238.9	1238.9	1238.9
		-13.00	1296.4	1296.4	1296.4
		-13.50	1353.9	1353.9	1353.9
		-14.00	1411.3	1411.3	1411.3
		-14.50	1468.8	1468.8	1468.8
		-15.00	1526.3	1526.3	1526.3
		-15.50	1583.7	1583.7	1583.7
		-16.00	1641.2	1641.2	1641.2
		-16.50	1698.7	1698.7	1698.7
		-17.00	1756.1	1756.1	1756.1
-17.50	1813.6	1813.6	1813.6		
-18.00	1871.1	1871.1	1871.1		
-18.50	1924.9	1924.9	1924.9		
-19.00	1982.4	1982.4	1982.4		
-19.50	2039.8	2039.8	2039.8		
-20.00	2097.3	2097.3	2097.3		
-20.50	2154.8	2154.8	2154.8		
-21.00	2212.3	2212.3	2212.3		
-21.50	2269.7	2269.7	2269.7		
-22.00	2327.2	2327.2	2327.2		
-22.50	2384.7	2384.7	2384.7		
-23.00	2442.1	2442.1	2442.1		
-23.50	2499.6	2499.6	2499.6		
166.S01	3.45	-7.00	407.0	407.0	407.0
		-7.50	464.5	464.5	464.5
		-8.00	522.0	522.0	522.0

Project : ZWO380 Funderingen
 Onderdeel : RLL-TBG380

Alle niveaus/hoogtes/peilmaten zijn t.o.v.: N.A.P.

sondering	maaiveld niveau	paalpunt niveau	Bezwijkdraagvermogen		
			R _{z,ca1} [kN]	R _{z,d} [kN]	R _{z,netto,zd} [kN]
166.S01	3.45	-8.50	579.0	579.0	579.0
		-9.00	636.0	636.0	636.0
		-9.50	692.2	692.2	692.2
		-10.00	749.7	749.7	749.7
		-10.50	807.2	807.2	807.2
		-11.00	864.6	864.6	864.6
		-11.50	922.1	922.1	922.1
		-12.00	975.6	975.6	975.6
		-12.50	1020.9	1020.9	1020.9
		-13.00	1063.6	1063.6	1063.6
		-13.50	1106.6	1106.6	1106.6
		-14.00	1156.3	1156.3	1156.3
		-14.50	1213.5	1213.5	1213.5
		-15.00	1271.0	1271.0	1271.0
		-15.50	1328.5	1328.5	1328.5
		-16.00	1385.9	1385.9	1385.9
		-16.50	1443.4	1443.4	1443.4
		-17.00	1500.9	1500.9	1500.9
		-17.50	1558.3	1558.3	1558.3
		-18.00	1615.8	1615.8	1615.8
		-18.50	1673.3	1673.3	1673.3
-19.00	1730.8	1730.8	1730.8		
-19.50	1788.2	1788.2	1788.2		
-20.00	1845.7	1845.7	1845.7		
-20.50	1903.2	1903.2	1903.2		
-21.00	1960.6	1960.6	1960.6		
-21.50	2018.1	2018.1	2018.1		
-22.00	2075.6	2075.6	2075.6		
-22.50	2133.0	2133.0	2133.0		
19-1008_11	0.62	-7.00	216.1	216.1	216.1
		-7.50	233.6	233.6	233.6
		-8.00	258.1	258.1	258.1
		-8.50	280.7	280.7	280.7
		-9.00	298.8	298.8	298.8
		-9.50	316.1	316.1	316.1
		-10.00	333.9	333.9	333.9
		-10.50	354.9	354.9	354.9
		-11.00	378.9	378.9	378.9
		-11.50	407.3	407.3	407.3
		-12.00	442.5	442.5	442.5
		-12.50	457.1	457.1	457.1
		-13.00	498.4	498.4	498.4
		-13.50	546.3	546.3	546.3
		-14.00	595.1	595.1	595.1
		-14.50	644.5	644.5	644.5
		-15.00	693.8	693.8	693.8
		-15.50	740.3	740.3	740.3
		-16.00	779.8	779.8	779.8
		-16.50	825.8	825.8	825.8
		-17.00	870.5	870.5	870.5
		-17.50	912.6	912.6	912.6
		-18.00	965.1	965.1	965.1
		-18.50	1022.5	1022.5	1022.5
		-19.00	1080.0	1080.0	1080.0
		-19.50	1137.5	1137.5	1137.5
		-20.00	1194.9	1194.9	1194.9
		-20.50	1252.4	1252.4	1252.4
		-21.00	1309.9	1309.9	1309.9
		-21.50	1364.3	1364.3	1364.3
-22.00	1421.7	1421.7	1421.7		
-22.50	1479.2	1479.2	1479.2		
-23.00	1531.9	1531.9	1531.9		
-23.50	1567.5	1567.5	1567.5		
-24.00	1612.7	1612.7	1612.7		
-24.50	1663.6	1663.6	1663.6		
-25.00	1712.3	1712.3	1712.3		
-25.50	1753.6	1753.6	1753.6		
-26.00	1811.8	1811.8	1811.8		
-26.50	1869.3	1869.3	1869.3		
-27.00	1926.8	1926.8	1926.8		
-27.50	1984.3	1984.3	1984.3		
-28.00	2041.7	2041.7	2041.7		
-28.50	2099.2	2099.2	2099.2		
-29.00	2156.7	2156.7	2156.7		
-29.50	2214.1	2214.1	2214.1		
-30.00	2271.6	2271.6	2271.6		
19-1008_12	3.57	-7.00	626.1	626.1	626.1
		-7.50	683.6	683.6	683.6
		-8.00	740.7	740.7	740.7
		-8.50	771.2	771.2	771.2
		-9.00	781.9	781.9	781.9
		-9.50	790.3	790.3	790.3
		-10.00	804.7	804.7	804.7
		-10.50	831.4	831.4	831.4
		-11.00	852.5	852.5	852.5
		-11.50	858.7	858.7	858.7
		-12.00	878.6	878.6	878.6
		-12.50	887.4	887.4	887.4
		-13.00	894.8	894.8	894.8
		-13.50	903.5	903.5	903.5
		-14.00	921.0	921.0	921.0
-14.50	943.3	943.3	943.3		
-15.00	959.6	959.6	959.6		
-15.50	973.0	973.0	973.0		

Project : ZWO380 Funderingen
 Onderdeel : RLL-TBG380

Alle niveaus/hoogtes/peilmaten zijn t.o.v.: N.A.P.

sondering	maaiveld niveau	paalpunt niveau	Bezwijkdraagvermogen		
			$R_{t,caal}$ [kN]	$R_{t,d}$ [kN]	$R_{t,netto,d}$ [kN]
19-1008_12	3.57	-16.00	993.3	993.3	993.3
		-16.50	1020.2	1020.2	1020.2
		-17.00	1043.0	1043.0	1043.0
		-17.50	1075.7	1075.7	1075.7
		-18.00	1101.6	1101.6	1101.6
		-18.50	1158.3	1158.3	1158.3
		-19.00	1210.3	1210.3	1210.3
		-19.50	1258.2	1258.2	1258.2
		-20.00	1299.7	1299.7	1299.7
		-20.50	1346.2	1346.2	1346.2
		-21.00	1389.9	1389.9	1389.9
		-21.50	1442.4	1442.4	1442.4
		-22.00	1499.1	1499.1	1499.1
		-22.50	1555.8	1555.8	1555.8
		-23.00	1607.9	1607.9	1607.9
		-23.50	1658.1	1658.1	1658.1
		-24.00	1711.6	1711.6	1711.6
		-24.50	1769.0	1769.0	1769.0
		-25.00	1826.5	1826.5	1826.5
		-25.50	1901.6	1901.6	1901.6
		-26.00	1977.0	1977.0	1977.0
		-26.50	2021.6	2021.6	2021.6
		-27.00	2063.3	2063.3	2063.3
		-27.50	2110.9	2110.9	2110.9
		-28.00	2145.9	2145.9	2145.9
		-28.50	2190.2	2190.2	2190.2
		-29.00	2247.7	2247.7	2247.7
		-29.50	2305.2	2305.2	2305.2
		-30.00	2361.6	2361.6	2361.6
		19-1008_17	0.20	-7.00	129.7
-7.50	144.9			144.9	144.9
-8.00	152.3			152.3	152.3
-8.50	160.8			160.8	160.8
-9.00	174.8			174.8	174.8
-9.50	186.0			186.0	186.0
-10.00	229.0			229.0	229.0
-10.50	251.5			251.5	251.5
-11.00	288.7			288.7	288.7
-11.50	346.2			346.2	346.2
-12.00	403.7			403.7	403.7
-12.50	461.1			461.1	461.1
-13.00	518.6			518.6	518.6
-13.50	576.1			576.1	576.1
-14.00	633.5			633.5	633.5
-14.50	691.0			691.0	691.0
-15.00	744.4			744.4	744.4
-15.50	801.9			801.9	801.9
-16.00	859.3			859.3	859.3
-16.50	916.8			916.8	916.8
-17.00	972.1			972.1	972.1
-17.50	1031.5			1031.5	1031.5
-18.00	1100.0			1100.0	1100.0
-18.50	1146.7			1146.7	1146.7
-19.00	1187.4			1187.4	1187.4
-19.50	1233.9			1233.9	1233.9
-20.00	1280.9			1280.9	1280.9
-20.50	1330.5			1330.5	1330.5
-21.00	1381.6			1381.6	1381.6
-21.50	1439.2			1439.2	1439.2
-22.00	1488.8	1488.8	1488.8		
-22.50	1546.2	1546.2	1546.2		
-23.00	1603.7	1603.7	1603.7		
-23.50	1661.2	1661.2	1661.2		
-24.00	1714.6	1714.6	1714.6		
-24.50	1761.1	1761.1	1761.1		
-25.00	1797.8	1797.8	1797.8		
-25.50	1833.4	1833.4	1833.4		
-26.00	1868.3	1868.3	1868.3		
-26.50	1903.1	1903.1	1903.1		
-27.00	1943.9	1943.9	1943.9		
-27.50	1987.5	1987.5	1987.5		
-28.00	2032.1	2032.1	2032.1		
-28.50	2078.6	2078.6	2078.6		
-29.00	2127.3	2127.3	2127.3		
-29.50	2142.8	2142.8	2142.8		
-30.00	2180.3	2180.3	2180.3		
19-1008_20	-0.03	-7.00	169.9	169.9	169.9
		-7.50	201.8	201.8	201.8
		-8.00	227.1	227.1	227.1
		-8.50	251.7	251.7	251.7
		-9.00	285.0	285.0	285.0
		-9.50	312.4	312.4	312.4
		-10.00	343.6	343.6	343.6
		-10.50	352.9	352.9	352.9
		-11.00	393.0	393.0	393.0
		-11.50	435.8	435.8	435.8
		-12.00	446.2	446.2	446.2
		-12.50	457.6	457.6	457.6
		-13.00	477.5	477.5	477.5
		-13.50	487.7	487.7	487.7
		-14.00	505.5	505.5	505.5
-14.50	536.4	536.4	536.4		
-15.00	571.3	571.3	571.3		
-15.50	592.0	592.0	592.0		

Project : ZWO380 Funderingen
 Onderdeel : RLL-TBG380

Alle niveaus/hoogtes/peilmaten zijn t.o.v.: N.A.P.

sondering	maaiveld niveau	paalpunt niveau	Bezwijkdraagvermogen		
			$R_{t,ca1}$ [kN]	$R_{t,d}$ [kN]	$R_{t,netto,d}$ [kN]
19-1008_20	-0.03	-16.00	608.1	608.1	608.1
		-16.50	630.0	630.0	630.0
		-17.00	645.0	645.0	645.0
		-17.50	662.9	662.9	662.9
		-18.00	694.2	694.2	694.2
		-18.50	730.4	730.4	730.4
		-19.00	758.1	758.1	758.1
		-19.50	794.6	794.6	794.6
		-20.00	832.3	832.3	832.3
		-20.50	879.9	879.9	879.9
		-21.00	943.0	943.0	943.0
		-21.50	971.1	971.1	971.1
		-22.00	990.5	990.5	990.5
		-22.50	1011.4	1011.4	1011.4
		-23.00	1028.7	1028.7	1028.7
		-23.50	1060.2	1060.2	1060.2
		-24.00	1095.1	1095.1	1095.1
		-24.50	1131.6	1131.6	1131.6
		-25.00	1176.0	1176.0	1176.0
		-25.50	1216.5	1216.5	1216.5
		-26.00	1256.2	1256.2	1256.2
		-26.50	1292.2	1292.2	1292.2
		-27.00	1335.9	1335.9	1335.9
		-27.50	1374.4	1374.4	1374.4
		-28.00	1409.4	1409.4	1409.4
		-28.50	1450.0	1450.0	1450.0
		-29.00	1487.9	1487.9	1487.9
		-29.50	1518.8	1518.8	1518.8
		-30.00	1557.2	1557.2	1557.2
		19-1008_21	1.78	-7.00	270.9
-7.50	316.4			316.4	316.4
-8.00	359.3			359.3	359.3
-8.50	402.8			402.8	402.8
-9.00	426.3			426.3	426.3
-9.50	444.7			444.7	444.7
-10.00	471.3			471.3	471.3
-10.50	495.0			495.0	495.0
-11.00	521.8			521.8	521.8
-11.50	555.0			555.0	555.0
-12.00	592.0			592.0	592.0
-12.50	621.0			621.0	621.0
-13.00	654.1			654.1	654.1
-13.50	690.5			690.5	690.5
-14.00	743.4			743.4	743.4
-14.50	796.4			796.4	796.4
-15.00	836.0			836.0	836.0
-15.50	867.3			867.3	867.3
-16.00	923.0			923.0	923.0
-16.50	978.9			978.9	978.9
-17.00	990.2			990.2	990.2
-17.50	1003.0			1003.0	1003.0
-18.00	1025.2			1025.2	1025.2
-18.50	1085.9			1085.9	1085.9
-19.00	1128.2			1128.2	1128.2
-19.50	1140.9			1140.9	1140.9
-20.00	1151.4			1151.4	1151.4
-20.50	1161.8			1161.8	1161.8
-21.00	1172.3			1172.3	1172.3
-21.50	1184.5			1184.5	1184.5
-22.00	1198.2	1198.2	1198.2		
-22.50	1214.5	1214.5	1214.5		
-23.00	1230.6	1230.6	1230.6		
-23.50	1246.2	1246.2	1246.2		
-24.00	1264.2	1264.2	1264.2		
-24.50	1282.6	1282.6	1282.6		
-25.00	1301.9	1301.9	1301.9		
-25.50	1322.1	1322.1	1322.1		
-26.00	1341.4	1341.4	1341.4		
-26.50	1359.2	1359.2	1359.2		
-27.00	1377.4	1377.4	1377.4		
-27.50	1395.3	1395.3	1395.3		
-28.00	1414.4	1414.4	1414.4		
-28.50	1434.0	1434.0	1434.0		
-29.00	1453.2	1453.2	1453.2		
-29.50	1473.1	1473.1	1473.1		
-30.00	1494.3	1494.3	1494.3		
251.S01	-1.05	-7.00	322.4	322.4	322.4
		-7.50	367.5	367.5	367.5
		-8.00	409.1	409.1	409.1
		-8.50	437.9	437.9	437.9
		-9.00	444.3	444.3	444.3
		-9.50	471.1	471.1	471.1
		-10.00	510.5	510.5	510.5
		-10.50	556.3	556.3	556.3
		-11.00	591.8	591.8	591.8
		-11.50	614.3	614.3	614.3
		-12.00	636.6	636.6	636.6
		-12.50	672.9	672.9	672.9
		-13.00	715.4	715.4	715.4
		-13.50	755.6	755.6	755.6
		-14.00	810.4	810.4	810.4
-14.50	864.9	864.9	864.9		
-15.00	923.7	923.7	923.7		
-15.50	951.4	951.4	951.4		

Project : ZWO380 Funderingen
 Onderdeel : RLL-TBG380

Alle niveaus/hoogtes/peilmaten zijn t.o.v.: N.A.P.

sondering	maaiveld niveau	paalpunt niveau	Bezwijkdraagvermogen		
			$R_{t,ca1}$ [kN]	$R_{t,d}$ [kN]	$R_{t,netto,d}$ [kN]
251.S01	-1.05	-16.00	1004.7	1004.7	1004.7
		-16.50	1062.2	1062.2	1062.2
		-17.00	1119.1	1119.1	1119.1
		-17.50	1173.5	1173.5	1173.5
		-18.00	1225.0	1225.0	1225.0
		-18.50	1282.4	1282.4	1282.4
		-19.00	1317.9	1317.9	1317.9
		-19.50	1355.7	1355.7	1355.7
		-20.00	1400.9	1400.9	1400.9
		-20.50	1463.3	1463.3	1463.3
		-21.00	1528.8	1528.8	1528.8
		-21.50	1557.4	1557.4	1557.4
		-22.00	1568.0	1568.0	1568.0
		-22.50	1581.3	1581.3	1581.3
		-23.00	1601.1	1601.1	1601.1
		-23.50	1626.3	1626.3	1626.3
		-24.00	1659.4	1659.4	1659.4
		-24.50	1689.9	1689.9	1689.9
		-25.00	1717.7	1717.7	1717.7
		-25.50	1765.7	1765.7	1765.7
		-26.00	1835.0	1835.0	1835.0
		-26.50	1902.8	1902.8	1902.8
		-27.00	1960.3	1960.3	1960.3
		-27.50	2017.7	2017.7	2017.7
		-28.00	2075.2	2075.2	2075.2
		-28.50	2132.7	2132.7	2132.7
		-29.00	2190.1	2190.1	2190.1
		-29.50	2229.9	2229.9	2229.9
		-30.00	2276.4	2276.4	2276.4
		19-1008_29	0.79	-7.00	438.4
-7.50	487.8			487.8	487.8
-8.00	540.5			540.5	540.5
-8.50	593.0			593.0	593.0
-9.00	638.9			638.9	638.9
-9.50	681.9			681.9	681.9
-10.00	722.3			722.3	722.3
-10.50	768.9			768.9	768.9
-11.00	815.1			815.1	815.1
-11.50	866.5			866.5	866.5
-12.00	891.9			891.9	891.9
-12.50	945.6			945.6	945.6
-13.00	987.2			987.2	987.2
-13.50	1005.7			1005.7	1005.7
-14.00	1027.1			1027.1	1027.1
-14.50	1042.7			1042.7	1042.7
-15.00	1056.4			1056.4	1056.4
-15.50	1072.4			1072.4	1072.4
-16.00	1110.2			1110.2	1110.2
-16.50	1125.4			1125.4	1125.4
-17.00	1140.8			1140.8	1140.8
-17.50	1161.8			1161.8	1161.8
-18.00	1210.1			1210.1	1210.1
-18.50	1267.6			1267.6	1267.6
-19.00	1324.5			1324.5	1324.5
-19.50	1368.2			1368.2	1368.2
-20.00	1425.7			1425.7	1425.7
-20.50	1483.2			1483.2	1483.2
-21.00	1540.6			1540.6	1540.6
-21.50	1598.1			1598.1	1598.1
-22.00	1655.6	1655.6	1655.6		
-22.50	1721.9	1721.9	1721.9		
-23.00	1772.6	1772.6	1772.6		
-23.50	1807.7	1807.7	1807.7		
-24.00	1848.5	1848.5	1848.5		
-24.50	1890.1	1890.1	1890.1		
-25.00	1934.1	1934.1	1934.1		
-25.50	1962.3	1962.3	1962.3		
-26.00	1994.4	1994.4	1994.4		
-26.50	2024.5	2024.5	2024.5		
-27.00	2061.6	2061.6	2061.6		
-27.50	2090.3	2090.3	2090.3		
-28.00	2118.3	2118.3	2118.3		
-28.50	2146.2	2146.2	2146.2		
-29.00	2176.6	2176.6	2176.6		
-29.50	2223.3	2223.3	2223.3		
-30.00	2264.1	2264.1	2264.1		
283.S02	0.17	-7.00	359.9	359.9	359.9
		-7.50	392.4	392.4	392.4
		-8.00	424.6	424.6	424.6
		-8.50	463.2	463.2	463.2
		-9.00	498.9	498.9	498.9
		-9.50	529.6	529.6	529.6
		-10.00	563.8	563.8	563.8
		-10.50	596.9	596.9	596.9
		-11.00	629.2	629.2	629.2
		-11.50	663.8	663.8	663.8
		-12.00	686.9	686.9	686.9
		-12.50	725.1	725.1	725.1
		-13.00	767.4	767.4	767.4
		-13.50	814.2	814.2	814.2
		-14.00	869.2	869.2	869.2
-14.50	924.1	924.1	924.1		
-15.00	973.6	973.6	973.6		
-15.50	1016.2	1016.2	1016.2		

Project : ZWO380 Funderingen
 Onderdeel : RLL-TBG380

Alle niveaus/hoogtes/peilmaten zijn t.o.v.: N.A.P.

sondering	maaiveld niveau	paalpunt niveau	Bezwijkdraagvermogen		
			$R_{t,ca1}$ [kN]	$R_{t,d}$ [kN]	$R_{t,netto,d}$ [kN]
283.S02	0.17	-16.00	1062.7	1062.7	1062.7
		-16.50	1114.2	1114.2	1114.2
		-17.00	1169.2	1169.2	1169.2
		-17.50	1226.7	1226.7	1226.7
		-18.00	1284.2	1284.2	1284.2
		-18.50	1341.7	1341.7	1341.7
		-19.00	1399.1	1399.1	1399.1
		-19.50	1456.6	1456.6	1456.6
		-20.00	1514.1	1514.1	1514.1
		-20.50	1569.2	1569.2	1569.2
		-21.00	1626.6	1626.6	1626.6
		-21.50	1684.1	1684.1	1684.1
		-22.00	1741.6	1741.6	1741.6
		-22.50	1799.0	1799.0	1799.0
		-23.00	1856.5	1856.5	1856.5
		-23.50	1914.0	1914.0	1914.0
		-24.00	1971.5	1971.5	1971.5
		-24.50	2028.9	2028.9	2028.9
		-25.00	2086.4	2086.4	2086.4
		-25.50	2143.9	2143.9	2143.9
		-26.00	2201.3	2201.3	2201.3
		-26.50	2263.0	2263.0	2263.0
		-27.00	2285.5	2285.5	2285.5
		-27.50	2307.1	2307.1	2307.1
		-28.00	2333.5	2333.5	2333.5
		-28.50	2366.3	2366.3	2366.3
		-29.00	2390.5	2390.5	2390.5
		-29.50	2412.0	2412.0	2412.0
		-30.00	2432.2	2432.2	2432.2
		19-1008_35	0.92	-7.00	357.3
-7.50	379.6			379.6	379.6
-8.00	409.6			409.6	409.6
-8.50	439.8			439.8	439.8
-9.00	463.5			463.5	463.5
-9.50	487.3			487.3	487.3
-10.00	515.6			515.6	515.6
-10.50	542.2			542.2	542.2
-11.00	586.3			586.3	586.3
-11.50	624.2			624.2	624.2
-12.00	651.2			651.2	651.2
-12.50	674.8			674.8	674.8
-13.00	705.5			705.5	705.5
-13.50	741.3			741.3	741.3
-14.00	778.6			778.6	778.6
-14.50	823.8			823.8	823.8
-15.00	869.1			869.1	869.1
-15.50	914.9			914.9	914.9
-16.00	961.7			961.7	961.7
-16.50	1008.8			1008.8	1008.8
-17.00	1049.6			1049.6	1049.6
-17.50	1084.5			1084.5	1084.5
-18.00	1130.2			1130.2	1130.2
-18.50	1171.7			1171.7	1171.7
-19.00	1218.2			1218.2	1218.2
-19.50	1264.2			1264.2	1264.2
-20.00	1311.5			1311.5	1311.5
-20.50	1369.2			1369.2	1369.2
-21.00	1426.6			1426.6	1426.6
-21.50	1484.1			1484.1	1484.1
-22.00	1540.2	1540.2	1540.2		
-22.50	1597.7	1597.7	1597.7		
-23.00	1655.2	1655.2	1655.2		
-23.50	1712.6	1712.6	1712.6		
-24.00	1770.1	1770.1	1770.1		
-24.50	1826.6	1826.6	1826.6		
-25.00	1880.9	1880.9	1880.9		
-25.50	1942.5	1942.5	1942.5		
-26.00	2000.4	2000.4	2000.4		
-26.50	2051.1	2051.1	2051.1		
-27.00	2108.5	2108.5	2108.5		
-27.50	2166.0	2166.0	2166.0		
-28.00	2223.5	2223.5	2223.5		
-28.50	2280.9	2280.9	2280.9		
-29.00	2338.4	2338.4	2338.4		
-29.50	2395.9	2395.9	2395.9		
-30.00	2453.4	2453.4	2453.4		
312.S03	3.78	-7.00	461.4	461.4	461.4
		-7.50	493.5	493.5	493.5
		-8.00	528.6	528.6	528.6
		-8.50	586.1	586.1	586.1
		-9.00	643.5	643.5	643.5
		-9.50	701.0	701.0	701.0
		-10.00	758.5	758.5	758.5
		-10.50	815.7	815.7	815.7
		-11.00	870.2	870.2	870.2
		-11.50	927.7	927.7	927.7
		-12.00	985.1	985.1	985.1
		-12.50	1042.6	1042.6	1042.6
		-13.00	1098.6	1098.6	1098.6
		-13.50	1140.1	1140.1	1140.1
		-14.00	1186.6	1186.6	1186.6
-14.50	1233.1	1233.1	1233.1		
-15.00	1278.1	1278.1	1278.1		
-15.50	1324.5	1324.5	1324.5		

Project : ZWO380 Funderingen
 Onderdeel : RLL-TBG380

Alle niveaus/hoogtes/peilmaten zijn t.o.v.: N.A.P.

sondering	maaiveld niveau	paalpunt niveau	Bezwijkdraagvermogen		
			$R_{t,caal}$ [kN]	$R_{t,d}$ [kN]	$R_{t,netto,d}$ [kN]
312.S03	3.78	-16.00	1369.8	1369.8	1369.8
		-16.50	1416.3	1416.3	1416.3
		-17.00	1459.5	1459.5	1459.5
		-17.50	1493.7	1493.7	1493.7
		-18.00	1530.3	1530.3	1530.3
		-18.50	1575.6	1575.6	1575.6
		-19.00	1623.4	1623.4	1623.4
		-19.50	1672.6	1672.6	1672.6
		-20.00	1720.2	1720.2	1720.2
		-20.50	1762.3	1762.3	1762.3
		-21.00	1808.2	1808.2	1808.2
		-21.50	1851.2	1851.2	1851.2
		-22.00	1899.5	1899.5	1899.5
		-22.50	1955.6	1955.6	1955.6
		-23.00	2012.1	2012.1	2012.1
		-23.50	2067.0	2067.0	2067.0
		-24.00	2117.7	2117.7	2117.7
		-24.50	2175.2	2175.2	2175.2
		-25.00	2232.6	2232.6	2232.6
		-25.50	2286.8	2286.8	2286.8
		-26.00	2335.4	2335.4	2335.4
		-26.50	2391.7	2391.7	2391.7
		-27.00	2448.0	2448.0	2448.0
		-27.50	2479.9	2479.9	2479.9
		-28.00	2505.3	2505.3	2505.3
		-28.50	2525.3	2525.3	2525.3
		-29.00	2545.0	2545.0	2545.0
		-29.50	2567.5	2567.5	2567.5
		-30.00	2597.3	2597.3	2597.3
		19-1008_43	9.88	-7.00	353.6
-7.50	397.2			397.2	397.2
-8.00	442.4			442.4	442.4
-8.50	484.7			484.7	484.7
-9.00	527.9			527.9	527.9
-9.50	572.1			572.1	572.1
-10.00	612.6			612.6	612.6
-10.50	661.0			661.0	661.0
-11.00	718.5			718.5	718.5
-11.50	776.0			776.0	776.0
-12.00	833.4			833.4	833.4
-12.50	890.5			890.5	890.5
-13.00	933.6			933.6	933.6
-13.50	971.0			971.0	971.0
-14.00	1014.2			1014.2	1014.2
-14.50	1060.7			1060.7	1060.7
-15.00	1101.7			1101.7	1101.7
-15.50	1152.1			1152.1	1152.1
-16.00	1207.5			1207.5	1207.5
-16.50	1264.9			1264.9	1264.9
-17.00	1322.4			1322.4	1322.4
-17.50	1377.8			1377.8	1377.8
-18.00	1428.3			1428.3	1428.3
-18.50	1473.7			1473.7	1473.7
-19.00	1519.1			1519.1	1519.1
-19.50	1556.4			1556.4	1556.4
-20.00	1594.7			1594.7	1594.7
-20.50	1642.5			1642.5	1642.5
-21.00	1697.8			1697.8	1697.8
-21.50	1743.7			1743.7	1743.7
-22.00	1795.5	1795.5	1795.5		
-22.50	1853.0	1853.0	1853.0		
-23.00	1910.5	1910.5	1910.5		
-23.50	1967.9	1967.9	1967.9		
-24.00	2025.4	2025.4	2025.4		
-24.50	2082.9	2082.9	2082.9		
-25.00	2131.7	2131.7	2131.7		
328.S02	10.17	-7.00	543.9	543.9	543.9
		-7.50	584.7	584.7	584.7
		-8.00	629.4	629.4	629.4
		-8.50	675.3	675.3	675.3
		-9.00	720.0	720.0	720.0
		-9.50	758.7	758.7	758.7
		-10.00	802.2	802.2	802.2
		-10.50	847.6	847.6	847.6
		-11.00	899.3	899.3	899.3
		-11.50	952.3	952.3	952.3
		-12.00	1003.6	1003.6	1003.6
		-12.50	1050.3	1050.3	1050.3
		-13.00	1095.9	1095.9	1095.9
		-13.50	1142.0	1142.0	1142.0
		-14.00	1188.5	1188.5	1188.5
		-14.50	1233.7	1233.7	1233.7
		-15.00	1280.6	1280.6	1280.6
		-15.50	1327.1	1327.1	1327.1
		-16.00	1373.1	1373.1	1373.1
		-16.50	1421.2	1421.2	1421.2
		-17.00	1478.7	1478.7	1478.7
		-17.50	1536.1	1536.1	1536.1
		-18.00	1601.7	1601.7	1601.7
		-18.50	1643.6	1643.6	1643.6
		-19.00	1695.5	1695.5	1695.5
		-19.50	1750.7	1750.7	1750.7
		-20.00	1808.2	1808.2	1808.2
		-20.50	1865.7	1865.7	1865.7

Project : ZWO380 Funderingen
 Onderdeel : RLL-TBG380

Alle niveaus/hoogtes/peilmaten zijn t.o.v.: N.A.P.

sondering	maaiveld niveau	paalpunt niveau	Bewijkdraagvermogen		
			$R_{t,ca1}$ [kN]	$R_{t,d}$ [kN]	$R_{t,netto;d}$ [kN]
328.S02	10.17	-21.00	1923.2	1923.2	1923.2
		-21.50	1980.6	1980.6	1980.6
		-22.00	2038.1	2038.1	2038.1
		-22.50	2095.6	2095.6	2095.6
		-23.00	2153.0	2153.0	2153.0
		-23.50	2210.5	2210.5	2210.5
		-24.00	2268.0	2268.0	2268.0
		-24.50	2316.9	2316.9	2316.9
		-25.00	2363.4	2363.4	2363.4
		-25.50	2409.2	2409.2	2409.2
		-26.00	2455.7	2455.7	2455.7
		-26.50	2504.9	2504.9	2504.9
		-27.00	2562.3	2562.3	2562.3
		-27.50	2619.8	2619.8	2619.8
		-28.00	2668.6	2668.6	2668.6
		-28.50	2711.4	2711.4	2711.4

REKENGEDEGENS SI Ø762/950 trek

Berekening : Ontwerpend
 Rekenmethode : Trekpalen volgens NEN-EN 1997-1, art. 7.6.3
 Sondering(en) : 19-1008_1, 19-1008_6, 166.S01, 19-1008_11, 19-1008_12
 : 19-1008_17, 19-1008_20, 19-1008_21, 251.S01, 19-1008_29
 : 283.S02, 19-1008_35, 312.S03, 19-1008_43, 328.S02

Let op: trekcapaciteit t.p.v. negatief kleefttraject is meegerekend.

Stijf bouwwerk : NEE
 Paalgroep : NEE
 Aantal sonderingen : 15
 Factor $\xi_{s(n-1)}$: 1.39 (handmatig)
 Factor $\xi_{s(qem)}$: 1.39 (handmatig)
 Factor $\xi_{s(min)}$: 1.39 (handmatig)
 Weerstandsfactor γ_R : 1.35
 $\gamma_{n;var;g;c}$: 1.50
 UGT draagvermogen zonder negatieve kleeft : NEE

Paal : SI Ø762/950
 Niveau paalkop [m] : N.A.P. 0.00
 Bovenbel. [kN/m²] : 0.00

PAALPUNTNIVEAUS SI Ø762/950

Alle niveaus/hoogtes/peilmaten zijn t.o.v. : N.A.P.

Nr	Beginniveau [m]	Eindniveau [m]	Stapgrootte [m]
1	-8.00	-30.00	0.50

RESULTATEN SI Ø762/950 trek (n=1)

Alle niveaus/hoogtes/peilmaten zijn t.o.v.: N.A.P.

Sondering	19-1008_1	19-1008_6	166.S01	19-1008_11	19-1008_12	19-1008_17
Niveau [m]	$F_{netto;t}$ [kN]	$F_{netto;t}$ [kN]	$F_{netto;t}$ [kN]	$F_{netto;t}$ [kN]	$F_{netto;t}$ [kN]	$F_{netto;t}$ [kN]
-8.00	116	859	623	313	881	188
-8.50	136	927	691	340	917	199
-9.00	144	995	759	362	930	216
-9.50	174	1063	825	383	941	230
-10.00	202	1131	894	404	958	281
-10.50	233	1200	962	429	990	308
-11.00	255	1268	1030	458	1016	352
-11.50	292	1336	1098	492	1024	420
-12.00	338	1404	1162	534	1048	489
-12.50	369	1473	1216	552	1058	557
-13.00	418	1541	1266	601	1068	625
-13.50	467	1609	1318	658	1078	693
-14.00	510	1677	1377	716	1100	762
-14.50	565	1745	1445	775	1126	830
-15.00	615	1814	1513	833	1146	893
-15.50	670	1882	1581	889	1162	961
-16.00	718	1950	1649	936	1187	1030
-16.50	770	2018	1718	990	1219	1098
-17.00	822	2087	1786	1043	1246	1164
-17.50	884	2155	1854	1094	1285	1234
-18.00	952	2223	1922	1156	1316	1315
-18.50	1020	2287	1990	1224	1384	1371
-19.00	1088	2355	2059	1292	1446	1419
-19.50	1157	2423	2127	1361	1502	1475
-20.00	1242	2492	2195	1429	1552	1530
-20.50	1329	2560	2263	1497	1607	1589
-21.00	1419	2628	2332	1565	1659	1650
-21.50	1483	2696	2400	1630	1722	1719
-22.00	1551	2764	2468	1698	1789	1777
-22.50	1619	2833	2536	1766	1856	1846
-23.00	1688	2901	0	1829	1918	1914
-23.50	1756	2969	0	1871	1978	1982
-24.00	1824	0	0	1925	2041	2046
-24.50	1892	0	0	1986	2109	2101
-25.00	1960	0	0	2044	2178	2145
-25.50	2029	0	0	2093	2267	2187
-26.00	2097	0	0	2162	2356	2229
-26.50	2165	0	0	2230	2409	2270
-27.00	2233	0	0	2298	2459	2319
-27.50	2302	0	0	2366	2515	2371
-28.00	2370	0	0	2435	2557	2424
-28.50	2438	0	0	2503	2610	2479

Project : ZWO380 Funderingen
 Onderdeel : RLL-TBG380

-29.00	2506	0	0	2571	2678	2537
-29.50	2574	0	0	2639	2746	2556
-30.00	2643	0	0	2708	2813	2600

RESULTATEN SI Ø762/950 trek (n=1)

Alle niveaus/hoogtes/peilmaten zijn t.o.v.: N.A.P.

Sondering	19-1008_20	19-1008_21	251.801	19-1008_29	283.502	19-1008_35
Niveau [m]	F _{nettozt} [kN]	F _{nettozt} [kN]	F _{nettozt} [kN]	F _{nettozt} [kN]	F _{nettozt} [kN]	F _{nettozt} [kN]
-8.00	277	432	492	645	509	491
-8.50	306	483	527	708	555	527
-9.00	346	512	535	762	598	555
-9.50	379	534	567	813	635	584
-10.00	416	566	614	861	675	618
-10.50	428	594	668	917	715	650
-11.00	475	626	710	972	753	702
-11.50	526	666	737	1033	795	747
-12.00	539	710	764	1063	822	780
-12.50	553	745	808	1127	868	808
-13.00	577	784	858	1177	918	845
-13.50	590	827	906	1199	974	887
-14.00	611	890	971	1225	1039	932
-14.50	648	953	1036	1244	1104	986
-15.00	690	1000	1106	1260	1163	1039
-15.50	714	1038	1139	1280	1214	1094
-16.00	734	1104	1202	1325	1269	1150
-16.50	760	1170	1270	1343	1331	1206
-17.00	778	1184	1338	1362	1396	1254
-17.50	800	1200	1402	1387	1464	1296
-18.00	837	1226	1464	1445	1532	1350
-18.50	881	1299	1532	1513	1601	1400
-19.00	914	1349	1574	1580	1669	1455
-19.50	957	1364	1619	1632	1737	1510
-20.00	1002	1377	1673	1701	1805	1566
-20.50	1059	1390	1747	1769	1871	1634
-21.00	1134	1403	1825	1837	1939	1703
-21.50	1167	1418	1859	1905	2007	1771
-22.00	1191	1434	1872	1973	2075	1837
-22.50	1216	1454	1888	2052	2144	1906
-23.00	1237	1474	1912	2112	2212	1974
-23.50	1274	1492	1942	2154	2280	2042
-24.00	1316	1514	1982	2203	2348	2110
-24.50	1359	1536	2018	2252	2416	2177
-25.00	1412	1560	2051	2305	2485	2242
-25.50	1460	1584	2108	2338	2553	2315
-26.00	1508	1607	2191	2377	2621	2384
-26.50	1551	1629	2271	2413	2694	2444
-27.00	1603	1651	2339	2457	2721	2512
-27.50	1649	1672	2407	2491	2747	2580
-28.00	1690	1695	2476	2525	2779	2649
-28.50	1739	1719	2544	2558	2818	2717
-29.00	1784	1742	2612	2595	2847	2785
-29.50	1821	1766	2659	2650	2873	2853
-30.00	1867	1792	2715	2699	2897	2921

Project : ZWO380 Funderingen
 Onderdeel : RLL-TBG380

RESULTATEN SI Ø762/950 trek (n=1)

Alle niveaus/hoogtes/peilmaten zijn t.o.v.: N.A.P.

Sondering 312.S03 19-1008_43 328.S02

Niveau [m]	F _{netto,t} [kN]	F _{netto,t} [kN]	F _{netto,t} [kN]
-8.00	631	529	750
-8.50	699	580	804
-9.00	767	631	858
-9.50	836	684	904
-10.00	904	732	955
-10.50	972	790	1009
-11.00	1037	858	1071
-11.50	1105	926	1134
-12.00	1173	994	1195
-12.50	1241	1062	1250
-13.00	1308	1113	1305
-13.50	1357	1158	1359
-14.00	1412	1209	1415
-14.50	1468	1265	1468
-15.00	1521	1313	1524
-15.50	1577	1373	1579
-16.00	1630	1439	1634
-16.50	1686	1507	1691
-17.00	1737	1576	1760
-17.50	1778	1641	1828
-18.00	1822	1701	1906
-18.50	1875	1755	1956
-19.00	1932	1809	2017
-19.50	1991	1854	2083
-20.00	2047	1899	2151
-20.50	2097	1956	2219
-21.00	2152	2022	2287
-21.50	2203	2077	2356
-22.00	2261	2138	2424
-22.50	2327	2206	2492
-23.00	2394	2275	2560
-23.50	2460	2343	2629
-24.00	2520	2411	2697
-24.50	2588	2479	2755
-25.00	2656	2537	2810
-25.50	2721	0	2865
-26.00	2778	0	2920
-26.50	2845	0	2978
-27.00	2912	0	3047
-27.50	2950	0	3115
-28.00	2980	0	3173
-28.50	3005	0	3224
-29.00	3028	0	0
-29.50	3055	0	0
-30.00	3091	0	0

Project : ZWO380 Funderingen
 Onderdeel : RLL-TBG380

SAMENVATTINGSTABEL SI Ø762/950 trek (n=1)
Uitgangspunten

- paal : SI Ø762/950
 - paaltype : In de grond gevormde geschroefde paal; groutinjectie
 - schachtafmeting : 860 mm
 Paalklassefactor α_p : 0.63
 Factor α_s (tabel 7.c EC 7.1) : 0.0090 (zandlagen; voor kleilagen zie tabel 7.d)
 Correlatiefactor $\xi_{s(n=1)}$: 1.39

Alle niveaus/hoogtes/peilmaten zijn t.o.v.: N.A.P.

sondering	maaiveld niveau	paalpunt niveau	Bewijkdraagvermogen		
			$R_{t,calc}$ [kN]	$R_{t,d}$ [kN]	$R_{t,netto,d}$ [kN]
19-1008_1	2.12	-8.00	116.1	116.1	116.1
		-8.50	135.8	135.8	135.8
		-9.00	144.1	144.1	144.1
		-9.50	174.3	174.3	174.3
		-10.00	201.6	201.6	201.6
		-10.50	233.0	233.0	233.0
		-11.00	255.4	255.4	255.4
		-11.50	291.8	291.8	291.8
		-12.00	337.7	337.7	337.7
		-12.50	369.3	369.3	369.3
		-13.00	418.3	418.3	418.3
		-13.50	467.1	467.1	467.1
		-14.00	509.6	509.6	509.6
		-14.50	564.6	564.6	564.6
		-15.00	615.4	615.4	615.4
		-15.50	670.3	670.3	670.3
		-16.00	717.7	717.7	717.7
		-16.50	769.7	769.7	769.7
		-17.00	822.5	822.5	822.5
		-17.50	883.7	883.7	883.7
		-18.00	951.9	951.9	951.9
		-18.50	1020.1	1020.1	1020.1
		-19.00	1088.3	1088.3	1088.3
		-19.50	1156.5	1156.5	1156.5
		-20.00	1242.0	1242.0	1242.0
		-20.50	1328.7	1328.7	1328.7
		-21.00	1418.5	1418.5	1418.5
		-21.50	1482.9	1482.9	1482.9
		-22.00	1551.1	1551.1	1551.1
		-22.50	1619.3	1619.3	1619.3
-23.00	1687.5	1687.5	1687.5		
-23.50	1755.8	1755.8	1755.8		
-24.00	1824.0	1824.0	1824.0		
-24.50	1892.2	1892.2	1892.2		
-25.00	1960.4	1960.4	1960.4		
-25.50	2028.7	2028.7	2028.7		
-26.00	2096.9	2096.9	2096.9		
-26.50	2165.1	2165.1	2165.1		
-27.00	2233.3	2233.3	2233.3		
-27.50	2301.5	2301.5	2301.5		
-28.00	2369.8	2369.8	2369.8		
-28.50	2438.0	2438.0	2438.0		
-29.00	2506.2	2506.2	2506.2		
-29.50	2574.4	2574.4	2574.4		
-30.00	2642.7	2642.7	2642.7		
19-1008_6	11.00	-8.00	858.5	858.5	858.5
		-8.50	926.7	926.7	926.7
		-9.00	995.0	995.0	995.0
		-9.50	1063.2	1063.2	1063.2
		-10.00	1131.4	1131.4	1131.4
		-10.50	1199.6	1199.6	1199.6
		-11.00	1267.8	1267.8	1267.8
		-11.50	1336.1	1336.1	1336.1
		-12.00	1404.3	1404.3	1404.3
		-12.50	1472.5	1472.5	1472.5
		-13.00	1540.7	1540.7	1540.7
		-13.50	1609.0	1609.0	1609.0
		-14.00	1677.2	1677.2	1677.2
		-14.50	1745.4	1745.4	1745.4
		-15.00	1813.6	1813.6	1813.6
		-15.50	1881.9	1881.9	1881.9
		-16.00	1950.1	1950.1	1950.1
		-16.50	2018.3	2018.3	2018.3
		-17.00	2086.5	2086.5	2086.5
		-17.50	2154.7	2154.7	2154.7
-18.00	2223.0	2223.0	2223.0		
-18.50	2286.9	2286.9	2286.9		
-19.00	2355.1	2355.1	2355.1		
-19.50	2423.3	2423.3	2423.3		
-20.00	2491.6	2491.6	2491.6		
-20.50	2559.8	2559.8	2559.8		
-21.00	2628.0	2628.0	2628.0		
-21.50	2696.2	2696.2	2696.2		
-22.00	2764.5	2764.5	2764.5		
-22.50	2832.7	2832.7	2832.7		
-23.00	2900.9	2900.9	2900.9		
-23.50	2969.1	2969.1	2969.1		
166.S01	3.45	-8.00	623.2	623.2	623.2
		-8.50	691.0	691.0	691.0
		-9.00	758.6	758.6	758.6
		-9.50	825.4	825.4	825.4
		-10.00	893.6	893.6	893.6
		-10.50	961.8	961.8	961.8
-11.00	1030.0	1030.0	1030.0		

Project : ZWO380 Funderingen
 Onderdeel : RLL-TBG380

Alle niveaus/hoogtes/peilmaten zijn t.o.v.: N.A.P.

sondering	maaiveld niveau	paalpunt niveau	Bezwijkdraagvermogen		
			$R_{t,caal}$ [kN]	$R_{t,d}$ [kN]	$R_{t,netto,d}$ [kN]
166.S01	3.45	-11.50	1098.3	1098.3	1098.3
		-12.00	1161.8	1161.8	1161.8
		-12.50	1215.7	1215.7	1215.7
		-13.00	1266.5	1266.5	1266.5
		-13.50	1317.7	1317.7	1317.7
		-14.00	1376.8	1376.8	1376.8
		-14.50	1444.7	1444.7	1444.7
		-15.00	1512.9	1512.9	1512.9
		-15.50	1581.1	1581.1	1581.1
		-16.00	1649.4	1649.4	1649.4
		-16.50	1717.6	1717.6	1717.6
		-17.00	1785.8	1785.8	1785.8
		-17.50	1854.0	1854.0	1854.0
		-18.00	1922.2	1922.2	1922.2
		-18.50	1990.5	1990.5	1990.5
		-19.00	2058.7	2058.7	2058.7
		-19.50	2126.9	2126.9	2126.9
		-20.00	2195.1	2195.1	2195.1
		-20.50	2263.4	2263.4	2263.4
		-21.00	2331.6	2331.6	2331.6
-21.50	2399.8	2399.8	2399.8		
-22.00	2468.0	2468.0	2468.0		
-22.50	2536.3	2536.3	2536.3		
19-1008_11	0.62	-8.00	312.7	312.7	312.7
		-8.50	339.9	339.9	339.9
		-9.00	361.6	361.6	361.6
		-9.50	382.6	382.6	382.6
		-10.00	404.1	404.1	404.1
		-10.50	429.3	429.3	429.3
		-11.00	458.1	458.1	458.1
		-11.50	492.1	492.1	492.1
		-12.00	534.0	534.0	534.0
		-12.50	551.9	551.9	551.9
		-13.00	600.9	600.9	600.9
		-13.50	658.0	658.0	658.0
		-14.00	716.0	716.0	716.0
		-14.50	774.6	774.6	774.6
		-15.00	833.3	833.3	833.3
		-15.50	888.6	888.6	888.6
		-16.00	935.6	935.6	935.6
		-16.50	990.4	990.4	990.4
		-17.00	1043.4	1043.4	1043.4
		-17.50	1093.6	1093.6	1093.6
		-18.00	1155.9	1155.9	1155.9
		-18.50	1224.2	1224.2	1224.2
		-19.00	1292.4	1292.4	1292.4
		-19.50	1360.6	1360.6	1360.6
		-20.00	1428.8	1428.8	1428.8
		-20.50	1497.0	1497.0	1497.0
		-21.00	1565.3	1565.3	1565.3
		-21.50	1629.8	1629.8	1629.8
		-22.00	1698.1	1698.1	1698.1
		-22.50	1766.3	1766.3	1766.3
-23.00	1828.9	1828.9	1828.9		
-23.50	1871.4	1871.4	1871.4		
-24.00	1925.1	1925.1	1925.1		
-24.50	1985.6	1985.6	1985.6		
-25.00	2043.5	2043.5	2043.5		
-25.50	2092.7	2092.7	2092.7		
-26.00	2161.8	2161.8	2161.8		
-26.50	2230.0	2230.0	2230.0		
-27.00	2298.3	2298.3	2298.3		
-27.50	2366.5	2366.5	2366.5		
-28.00	2434.7	2434.7	2434.7		
-28.50	2502.9	2502.9	2502.9		
-29.00	2571.2	2571.2	2571.2		
-29.50	2639.4	2639.4	2639.4		
-30.00	2707.6	2707.6	2707.6		
19-1008_12	3.57	-8.00	880.9	880.9	880.9
		-8.50	917.4	917.4	917.4
		-9.00	930.4	930.4	930.4
		-9.50	940.9	940.9	940.9
		-10.00	958.4	958.4	958.4
		-10.50	990.3	990.3	990.3
		-11.00	1015.8	1015.8	1015.8
		-11.50	1023.5	1023.5	1023.5
		-12.00	1047.5	1047.5	1047.5
		-12.50	1058.4	1058.4	1058.4
		-13.00	1067.7	1067.7	1067.7
		-13.50	1078.4	1078.4	1078.4
		-14.00	1099.6	1099.6	1099.6
		-14.50	1126.3	1126.3	1126.3
		-15.00	1146.0	1146.0	1146.0
		-15.50	1162.3	1162.3	1162.3
		-16.00	1186.8	1186.8	1186.8
		-16.50	1219.0	1219.0	1219.0
		-17.00	1246.4	1246.4	1246.4
		-17.50	1285.4	1285.4	1285.4
-18.00	1316.5	1316.5	1316.5		
-18.50	1383.7	1383.7	1383.7		
-19.00	1445.5	1445.5	1445.5		
-19.50	1502.5	1502.5	1502.5		
-20.00	1551.9	1551.9	1551.9		
-20.50	1607.2	1607.2	1607.2		

Project : ZWO380 Funderingen
 Onderdeel : RLL-TBG380

Alle niveaus/hoogtes/peilmaten zijn t.o.v.: N.A.P.

sondering	maaiveld niveau	paalpunt niveau	Bezwijkdraagvermogen		
			$R_{t,ca1}$ [kN]	$R_{t,d}$ [kN]	$R_{t,netto,d}$ [kN]
19-1008_12	3.57	-21.00	1659.2	1659.2	1659.2
		-21.50	1721.6	1721.6	1721.6
		-22.00	1788.9	1788.9	1788.9
		-22.50	1856.2	1856.2	1856.2
		-23.00	1918.1	1918.1	1918.1
		-23.50	1977.8	1977.8	1977.8
		-24.00	2041.3	2041.3	2041.3
		-24.50	2109.5	2109.5	2109.5
		-25.00	2177.7	2177.7	2177.7
		-25.50	2266.7	2266.7	2266.7
		-26.00	2356.1	2356.1	2356.1
		-26.50	2409.1	2409.1	2409.1
		-27.00	2458.8	2458.8	2458.8
		-27.50	2515.3	2515.3	2515.3
		-28.00	2557.1	2557.1	2557.1
		-28.50	2609.9	2609.9	2609.9
		-29.00	2678.1	2678.1	2678.1
		-29.50	2746.3	2746.3	2746.3
		-30.00	2813.3	2813.3	2813.3
19-1008_17	0.20	-8.00	188.4	188.4	188.4
		-8.50	198.9	198.9	198.9
		-9.00	216.0	216.0	216.0
		-9.50	229.6	229.6	229.6
		-10.00	280.8	280.8	280.8
		-10.50	307.8	307.8	307.8
		-11.00	352.2	352.2	352.2
		-11.50	420.5	420.5	420.5
		-12.00	488.7	488.7	488.7
		-12.50	556.9	556.9	556.9
		-13.00	625.1	625.1	625.1
		-13.50	693.4	693.4	693.4
		-14.00	761.6	761.6	761.6
		-14.50	829.8	829.8	829.8
		-15.00	893.2	893.2	893.2
		-15.50	961.4	961.4	961.4
		-16.00	1029.7	1029.7	1029.7
		-16.50	1097.9	1097.9	1097.9
		-17.00	1163.5	1163.5	1163.5
		-17.50	1234.0	1234.0	1234.0
		-18.00	1315.3	1315.3	1315.3
		-18.50	1370.8	1370.8	1370.8
		-19.00	1419.3	1419.3	1419.3
		-19.50	1474.6	1474.6	1474.6
		-20.00	1530.5	1530.5	1530.5
		-20.50	1589.4	1589.4	1589.4
		-21.00	1650.1	1650.1	1650.1
		-21.50	1718.5	1718.5	1718.5
		-22.00	1777.4	1777.4	1777.4
-22.50	1845.6	1845.6	1845.6		
-23.00	1913.9	1913.9	1913.9		
-23.50	1982.1	1982.1	1982.1		
-24.00	2045.6	2045.6	2045.6		
-24.50	2100.8	2100.8	2100.8		
-25.00	2144.6	2144.6	2144.6		
-25.50	2187.1	2187.1	2187.1		
-26.00	2228.7	2228.7	2228.7		
-26.50	2270.2	2270.2	2270.2		
-27.00	2318.8	2318.8	2318.8		
-27.50	2370.7	2370.7	2370.7		
-28.00	2423.7	2423.7	2423.7		
-28.50	2479.0	2479.0	2479.0		
-29.00	2536.9	2536.9	2536.9		
-29.50	2555.7	2555.7	2555.7		
-30.00	2600.4	2600.4	2600.4		
19-1008_20	-0.03	-8.00	276.7	276.7	276.7
		-8.50	306.3	306.3	306.3
		-9.00	346.0	346.0	346.0
		-9.50	378.7	378.7	378.7
		-10.00	416.1	416.1	416.1
		-10.50	427.6	427.6	427.6
		-11.00	475.3	475.3	475.3
		-11.50	526.3	526.3	526.3
		-12.00	539.0	539.0	539.0
		-12.50	553.0	553.0	553.0
		-13.00	576.9	576.9	576.9
		-13.50	589.5	589.5	589.5
		-14.00	611.0	611.0	611.0
		-14.50	647.9	647.9	647.9
		-15.00	689.5	689.5	689.5
		-15.50	714.4	714.4	714.4
		-16.00	733.9	733.9	733.9
		-16.50	760.2	760.2	760.2
		-17.00	778.4	778.4	778.4
		-17.50	800.0	800.0	800.0
		-18.00	837.4	837.4	837.4
-18.50	880.5	880.5	880.5		
-19.00	913.7	913.7	913.7		
-19.50	957.2	957.2	957.2		
-20.00	1002.1	1002.1	1002.1		
-20.50	1058.8	1058.8	1058.8		
-21.00	1133.6	1133.6	1133.6		
-21.50	1167.2	1167.2	1167.2		
-22.00	1190.6	1190.6	1190.6		
-22.50	1215.8	1215.8	1215.8		

Project : ZWO380 Funderingen
 Onderdeel : RLL-TBG380

Alle niveaus/hoogtes/peilmaten zijn t.o.v.: N.A.P.

sondering	maaiveld niveau	paalpunt niveau	Bezwijkdraagvermogen				
			R _{z,ca1} [kN]	R _{z,d} [kN]	R _{z,netto,zd} [kN]		
19-1008_20	-0.03	-23.00	1236.7	1236.7	1236.7		
		-23.50	1274.3	1274.3	1274.3		
		-24.00	1315.9	1315.9	1315.9		
		-24.50	1359.4	1359.4	1359.4		
		-25.00	1412.3	1412.3	1412.3		
		-25.50	1460.5	1460.5	1460.5		
		-26.00	1507.7	1507.7	1507.7		
		-26.50	1550.8	1550.8	1550.8		
		-27.00	1602.7	1602.7	1602.7		
		-27.50	1648.6	1648.6	1648.6		
		-28.00	1690.4	1690.4	1690.4		
		-28.50	1738.8	1738.8	1738.8		
		-29.00	1783.8	1783.8	1783.8		
		-29.50	1820.8	1820.8	1820.8		
		-30.00	1866.5	1866.5	1866.5		
		19-1008_21	1.78	-8.00	431.6	431.6	431.6
				-8.50	483.3	483.3	483.3
-9.00	511.6			511.6	511.6		
-9.50	533.7			533.7	533.7		
-10.00	565.6			565.6	565.6		
-10.50	594.1			594.1	594.1		
-11.00	626.2			626.2	626.2		
-11.50	665.8			665.8	665.8		
-12.00	709.9			709.9	709.9		
-12.50	744.5			744.5	744.5		
-13.00	784.1			784.1	784.1		
-13.50	827.4			827.4	827.4		
-14.00	890.3			890.3	890.3		
-14.50	953.3			953.3	953.3		
-15.00	1000.4			1000.4	1000.4		
-15.50	1037.8			1037.8	1037.8		
-16.00	1103.9			1103.9	1103.9		
-16.50	1170.3			1170.3	1170.3		
-17.00	1184.2			1184.2	1184.2		
-17.50	1199.8			1199.8	1199.8		
-18.00	1226.5			1226.5	1226.5		
-18.50	1298.5			1298.5	1298.5		
-19.00	1348.9			1348.9	1348.9		
-19.50	1364.3			1364.3	1364.3		
-20.00	1377.2			1377.2	1377.2		
-20.50	1390.0			1390.0	1390.0		
-21.00	1402.9			1402.9	1402.9		
-21.50	1417.8			1417.8	1417.8		
-22.00	1434.5			1434.5	1434.5		
-22.50	1454.1			1454.1	1454.1		
-23.00	1473.6			1473.6	1473.6		
-23.50	1492.5			1492.5	1492.5		
-24.00	1514.2			1514.2	1514.2		
-24.50	1536.5	1536.5	1536.5				
-25.00	1559.7	1559.7	1559.7				
-25.50	1584.0	1584.0	1584.0				
-26.00	1607.3	1607.3	1607.3				
-26.50	1628.8	1628.8	1628.8				
-27.00	1650.7	1650.7	1650.7				
-27.50	1672.3	1672.3	1672.3				
-28.00	1695.3	1695.3	1695.3				
-28.50	1719.0	1719.0	1719.0				
-29.00	1742.0	1742.0	1742.0				
-29.50	1766.1	1766.1	1766.1				
-30.00	1791.6	1791.6	1791.6				
251.S01	-1.05	-8.00	492.1	492.1	492.1		
		-8.50	526.5	526.5	526.5		
		-9.00	534.6	534.6	534.6		
		-9.50	566.7	566.7	566.7		
		-10.00	613.5	613.5	613.5		
		-10.50	668.1	668.1	668.1		
		-11.00	710.4	710.4	710.4		
		-11.50	737.4	737.4	737.4		
		-12.00	764.3	764.3	764.3		
		-12.50	807.5	807.5	807.5		
		-13.00	858.1	858.1	858.1		
		-13.50	906.0	906.0	906.0		
		-14.00	971.1	971.1	971.1		
		-14.50	1035.8	1035.8	1035.8		
		-15.00	1105.6	1105.6	1105.6		
		-15.50	1138.7	1138.7	1138.7		
		-16.00	1202.0	1202.0	1202.0		
		-16.50	1270.2	1270.2	1270.2		
		-17.00	1337.8	1337.8	1337.8		
		-17.50	1402.5	1402.5	1402.5		
		-18.00	1463.7	1463.7	1463.7		
		-18.50	1531.8	1531.8	1531.8		
		-19.00	1574.1	1574.1	1574.1		
		-19.50	1619.1	1619.1	1619.1		
-20.00	1673.0	1673.0	1673.0				
-20.50	1746.9	1746.9	1746.9				
-21.00	1824.6	1824.6	1824.6				
-21.50	1858.8	1858.8	1858.8				
-22.00	1871.9	1871.9	1871.9				
-22.50	1888.1	1888.1	1888.1				
-23.00	1911.9	1911.9	1911.9				
-23.50	1942.1	1942.1	1942.1				
-24.00	1981.7	1981.7	1981.7				
-24.50	2018.0	2018.0	2018.0				

Project : ZWO380 Funderingen
 Onderdeel : RLL-TBG380

Alle niveaus/hoogtes/peilmaten zijn t.o.v.: N.A.P.

sondering	maaiveld niveau	paalpunt niveau	Bezwijkdraagvermogen				
			$R_{t,caal}$ [kN]	$R_{t,d}$ [kN]	$R_{t,netto,d}$ [kN]		
251.S01	-1.05	-25.00	2051.3	2051.3	2051.3		
		-25.50	2108.4	2108.4	2108.4		
		-26.00	2190.5	2190.5	2190.5		
		-26.50	2271.0	2271.0	2271.0		
		-27.00	2339.2	2339.2	2339.2		
		-27.50	2407.4	2407.4	2407.4		
		-28.00	2475.6	2475.6	2475.6		
		-28.50	2543.8	2543.8	2543.8		
		-29.00	2612.1	2612.1	2612.1		
		-29.50	2659.5	2659.5	2659.5		
		-30.00	2714.7	2714.7	2714.7		
		19-1008_29	0.79	-8.00	645.3	645.3	645.3
				-8.50	707.6	707.6	707.6
-9.00	762.2			762.2	762.2		
-9.50	813.4			813.4	813.4		
-10.00	861.5			861.5	861.5		
-10.50	916.9			916.9	916.9		
-11.00	971.8			971.8	971.8		
-11.50	1032.9			1032.9	1032.9		
-12.00	1063.4			1063.4	1063.4		
-12.50	1127.2			1127.2	1127.2		
-13.00	1176.6			1176.6	1176.6		
-13.50	1199.0			1199.0	1199.0		
-14.00	1224.7			1224.7	1224.7		
-14.50	1243.6			1243.6	1243.6		
-15.00	1260.3			1260.3	1260.3		
-15.50	1279.7			1279.7	1279.7		
-16.00	1324.7			1324.7	1324.7		
-16.50	1343.2			1343.2	1343.2		
-17.00	1361.8			1361.8	1361.8		
-17.50	1387.1			1387.1	1387.1		
-18.00	1444.5			1444.5	1444.5		
-18.50	1512.7			1512.7	1512.7		
-19.00	1580.2			1580.2	1580.2		
-19.50	1632.3			1632.3	1632.3		
-20.00	1700.5			1700.5	1700.5		
-20.50	1768.8			1768.8	1768.8		
-21.00	1837.0			1837.0	1837.0		
-21.50	1905.2			1905.2	1905.2		
-22.00	1973.4			1973.4	1973.4		
-22.50	2052.0			2052.0	2052.0		
-23.00	2112.3			2112.3	2112.3		
-23.50	2154.2			2154.2	2154.2		
-24.00	2202.8			2202.8	2202.8		
-24.50	2252.3	2252.3	2252.3				
-25.00	2304.6	2304.6	2304.6				
-25.50	2338.4	2338.4	2338.4				
-26.00	2376.7	2376.7	2376.7				
-26.50	2412.7	2412.7	2412.7				
-27.00	2457.0	2457.0	2457.0				
-27.50	2491.3	2491.3	2491.3				
-28.00	2524.8	2524.8	2524.8				
-28.50	2558.1	2558.1	2558.1				
-29.00	2594.5	2594.5	2594.5				
-29.50	2650.0	2650.0	2650.0				
-30.00	2698.6	2698.6	2698.6				
283.S02	0.17	-8.00	509.2	509.2	509.2		
		-8.50	555.2	555.2	555.2		
		-9.00	597.8	597.8	597.8		
		-9.50	634.5	634.5	634.5		
		-10.00	675.3	675.3	675.3		
		-10.50	714.8	714.8	714.8		
		-11.00	753.4	753.4	753.4		
		-11.50	794.7	794.7	794.7		
		-12.00	822.4	822.4	822.4		
		-12.50	867.9	867.9	867.9		
		-13.00	918.2	918.2	918.2		
		-13.50	973.9	973.9	973.9		
		-14.00	1039.2	1039.2	1039.2		
		-14.50	1104.5	1104.5	1104.5		
		-15.00	1163.3	1163.3	1163.3		
		-15.50	1214.0	1214.0	1214.0		
		-16.00	1269.2	1269.2	1269.2		
		-16.50	1330.5	1330.5	1330.5		
		-17.00	1395.8	1395.8	1395.8		
		-17.50	1464.1	1464.1	1464.1		
		-18.00	1532.3	1532.3	1532.3		
		-18.50	1600.5	1600.5	1600.5		
		-19.00	1668.7	1668.7	1668.7		
		-19.50	1737.0	1737.0	1737.0		
		-20.00	1805.2	1805.2	1805.2		
		-20.50	1870.6	1870.6	1870.6		
-21.00	1938.8	1938.8	1938.8				
-21.50	2007.1	2007.1	2007.1				
-22.00	2075.3	2075.3	2075.3				
-22.50	2143.5	2143.5	2143.5				
-23.00	2211.7	2211.7	2211.7				
-23.50	2279.9	2279.9	2279.9				
-24.00	2348.2	2348.2	2348.2				
-24.50	2416.4	2416.4	2416.4				
-25.00	2484.6	2484.6	2484.6				
-25.50	2552.8	2552.8	2552.8				
-26.00	2621.1	2621.1	2621.1				
-26.50	2694.2	2694.2	2694.2				

Project : ZWO380 Funderingen
 Onderdeel : RLL-TBG380

Alle niveaus/hoogtes/peilmaten zijn t.o.v.: N.A.P.

sondering	maaiveld niveau	paalpunt niveau	Bezwijkdraagvermogen		
			$R_{t,ca1}$ [kN]	$R_{t,d}$ [kN]	$R_{t,netto,d}$ [kN]
283.S02	0.17	-27.00	2721.3	2721.3	2721.3
		-27.50	2747.2	2747.2	2747.2
		-28.00	2778.8	2778.8	2778.8
		-28.50	2818.0	2818.0	2818.0
		-29.00	2847.0	2847.0	2847.0
		-29.50	2872.9	2872.9	2872.9
		-30.00	2897.2	2897.2	2897.2
19-1008_35	0.92	-8.00	490.9	490.9	490.9
		-8.50	527.0	527.0	527.0
		-9.00	555.4	555.4	555.4
		-9.50	584.0	584.0	584.0
		-10.00	617.8	617.8	617.8
		-10.50	649.8	649.8	649.8
		-11.00	702.2	702.2	702.2
		-11.50	747.4	747.4	747.4
		-12.00	779.7	779.7	779.7
		-12.50	808.1	808.1	808.1
		-13.00	844.7	844.7	844.7
		-13.50	887.4	887.4	887.4
		-14.00	931.8	931.8	931.8
		-14.50	985.6	985.6	985.6
		-15.00	1039.5	1039.5	1039.5
		-15.50	1093.9	1093.9	1093.9
		-16.00	1149.7	1149.7	1149.7
		-16.50	1205.6	1205.6	1205.6
		-17.00	1254.2	1254.2	1254.2
		-17.50	1295.8	1295.8	1295.8
		-18.00	1350.2	1350.2	1350.2
		-18.50	1399.6	1399.6	1399.6
		-19.00	1454.9	1454.9	1454.9
		-19.50	1509.6	1509.6	1509.6
		-20.00	1565.9	1565.9	1565.9
		-20.50	1634.3	1634.3	1634.3
		-21.00	1702.5	1702.5	1702.5
		-21.50	1770.8	1770.8	1770.8
		-22.00	1837.4	1837.4	1837.4
		-22.50	1905.6	1905.6	1905.6
-23.00	1973.9	1973.9	1973.9		
-23.50	2042.1	2042.1	2042.1		
-24.00	2110.3	2110.3	2110.3		
-24.50	2177.4	2177.4	2177.4		
-25.00	2241.9	2241.9	2241.9		
-25.50	2315.0	2315.0	2315.0		
-26.00	2383.6	2383.6	2383.6		
-26.50	2443.9	2443.9	2443.9		
-27.00	2512.1	2512.1	2512.1		
-27.50	2580.3	2580.3	2580.3		
-28.00	2648.6	2648.6	2648.6		
-28.50	2716.8	2716.8	2716.8		
-29.00	2785.0	2785.0	2785.0		
-29.50	2853.2	2853.2	2853.2		
-30.00	2921.5	2921.5	2921.5		
312.S03	3.78	-8.00	631.0	631.0	631.0
		-8.50	699.2	699.2	699.2
		-9.00	767.5	767.5	767.5
		-9.50	835.7	835.7	835.7
		-10.00	903.9	903.9	903.9
		-10.50	971.9	971.9	971.9
		-11.00	1036.6	1036.6	1036.6
		-11.50	1104.8	1104.8	1104.8
		-12.00	1173.0	1173.0	1173.0
		-12.50	1241.3	1241.3	1241.3
		-13.00	1307.7	1307.7	1307.7
		-13.50	1357.2	1357.2	1357.2
		-14.00	1412.4	1412.4	1412.4
		-14.50	1467.7	1467.7	1467.7
		-15.00	1521.2	1521.2	1521.2
		-15.50	1576.5	1576.5	1576.5
		-16.00	1630.4	1630.4	1630.4
		-16.50	1685.7	1685.7	1685.7
		-17.00	1737.0	1737.0	1737.0
		-17.50	1777.9	1777.9	1777.9
		-18.00	1821.5	1821.5	1821.5
		-18.50	1875.4	1875.4	1875.4
		-19.00	1932.3	1932.3	1932.3
		-19.50	1990.7	1990.7	1990.7
		-20.00	2047.3	2047.3	2047.3
		-20.50	2097.3	2097.3	2097.3
		-21.00	2152.1	2152.1	2152.1
		-21.50	2203.2	2203.2	2203.2
		-22.00	2260.5	2260.5	2260.5
		-22.50	2327.2	2327.2	2327.2
-23.00	2394.3	2394.3	2394.3		
-23.50	2459.5	2459.5	2459.5		
-24.00	2519.7	2519.7	2519.7		
-24.50	2588.0	2588.0	2588.0		
-25.00	2656.2	2656.2	2656.2		
-25.50	2720.5	2720.5	2720.5		
-26.00	2778.3	2778.3	2778.3		
-26.50	2845.1	2845.1	2845.1		
-27.00	2912.0	2912.0	2912.0		
-27.50	2950.1	2950.1	2950.1		
-28.00	2980.5	2980.5	2980.5		
-28.50	3004.6	3004.6	3004.6		

Project : ZWO380 Funderingen
Onderdeel : RLL-TBG380

Alle niveaus/hoogtes/peilmaten zijn t.o.v.: N.A.P.

sondering	maaiveld paalpunt		Bezuikdraagvermogen		
	niveau	niveau	$R_{t,ca1}$ [kN]	$R_{t,d}$ [kN]	$R_{t,netto,d}$ [kN]
312.S03	3.78	-29.00	3028.3	3028.3	3028.3
		-29.50	3055.3	3055.3	3055.3
		-30.00	3091.0	3091.0	3091.0
19-1008_43	9.88	-8.00	529.5	529.5	529.5
		-8.50	579.8	579.8	579.8
		-9.00	631.3	631.3	631.3
		-9.50	683.9	683.9	683.9
		-10.00	732.1	732.1	732.1
		-10.50	789.7	789.7	789.7
		-11.00	857.9	857.9	857.9
		-11.50	926.1	926.1	926.1
		-12.00	994.3	994.3	994.3
		-12.50	1062.0	1062.0	1062.0
		-13.00	1113.3	1113.3	1113.3
		-13.50	1157.9	1157.9	1157.9
		-14.00	1209.3	1209.3	1209.3
		-14.50	1264.6	1264.6	1264.6
		-15.00	1313.4	1313.4	1313.4
		-15.50	1373.3	1373.3	1373.3
		-16.00	1439.1	1439.1	1439.1
		-16.50	1507.3	1507.3	1507.3
		-17.00	1575.5	1575.5	1575.5
		-17.50	1641.4	1641.4	1641.4
		-18.00	1701.3	1701.3	1701.3
		-18.50	1755.3	1755.3	1755.3
		-19.00	1809.4	1809.4	1809.4
		-19.50	1853.8	1853.8	1853.8
		-20.00	1899.5	1899.5	1899.5
		-20.50	1956.3	1956.3	1956.3
		-21.00	2021.9	2021.9	2021.9
		-21.50	2076.6	2076.6	2076.6
-22.00	2138.1	2138.1	2138.1		
-22.50	2206.3	2206.3	2206.3		
-23.00	2274.6	2274.6	2274.6		
-23.50	2342.8	2342.8	2342.8		
-24.00	2411.0	2411.0	2411.0		
-24.50	2479.2	2479.2	2479.2		
-25.00	2537.3	2537.3	2537.3		
328.S02	10.17	-8.00	749.8	749.8	749.8
		-8.50	804.4	804.4	804.4
		-9.00	857.6	857.6	857.6
		-9.50	903.7	903.7	903.7
		-10.00	955.5	955.5	955.5
		-10.50	1009.4	1009.4	1009.4
		-11.00	1070.8	1070.8	1070.8
		-11.50	1133.8	1133.8	1133.8
		-12.00	1194.8	1194.8	1194.8
		-12.50	1250.3	1250.3	1250.3
		-13.00	1304.5	1304.5	1304.5
		-13.50	1359.4	1359.4	1359.4
		-14.00	1414.6	1414.6	1414.6
		-14.50	1468.5	1468.5	1468.5
		-15.00	1524.3	1524.3	1524.3
		-15.50	1579.5	1579.5	1579.5
		-16.00	1634.2	1634.2	1634.2
		-16.50	1691.4	1691.4	1691.4
		-17.00	1759.6	1759.6	1759.6
		-17.50	1827.9	1827.9	1827.9
		-18.00	1905.7	1905.7	1905.7
		-18.50	1955.5	1955.5	1955.5
		-19.00	2017.2	2017.2	2017.2
		-19.50	2082.8	2082.8	2082.8
		-20.00	2151.0	2151.0	2151.0
		-20.50	2219.2	2219.2	2219.2
		-21.00	2287.4	2287.4	2287.4
		-21.50	2355.6	2355.6	2355.6
-22.00	2423.9	2423.9	2423.9		
-22.50	2492.1	2492.1	2492.1		
-23.00	2560.3	2560.3	2560.3		
-23.50	2628.5	2628.5	2628.5		
-24.00	2696.8	2696.8	2696.8		
-24.50	2754.9	2754.9	2754.9		
-25.00	2810.2	2810.2	2810.2		
-25.50	2864.7	2864.7	2864.7		
-26.00	2920.0	2920.0	2920.0		
-26.50	2978.5	2978.5	2978.5		
-27.00	3046.7	3046.7	3046.7		
-27.50	3114.9	3114.9	3114.9		
-28.00	3172.9	3172.9	3172.9		
-28.50	3223.8	3223.8	3223.8		

PAALGEGEVENS SI Ø508/670

Type : In de grond gevormde geschroefde paal; groutinjectie
 Wijze van installeren : Schroeven
 Wijze van terugwinnen : n.v.t.
 Diameter [m] : 0.590
 Elasticiteitsmodulus [N/mm²] : 20000
 Factor α_s (tabel 7.c EC 7.1) : 0.009 (zandlagen; voor kleilagen zie tabel 7.d)
 Factor α_c (tabel 7.c EC 7.1) : 0.0090 (zandlagen; voor kleilagen zie tabel 7.d)
 Paalklassefactor α_p : 0.63
 Paalvoetvormfactor β : 1.00
 Type lastzakingsdiagram : Grondverdringende paal
 Verm.factor * $\phi_{j,k}$: 1.00
 Groutomhulling : JA

Project : ZWO380 Funderingen
Onderdeel : RLL-TBG380

PAALGEGEVENS SI Ø610/850

Type : In de grond gevormde geschroefde paal; groutinjectie
Wijze van installeren : Schroeven
Wijze van terugwinnen : n.v.t.
Diameter [m] : 0.730
Elasticiteitsmodulus [N/mm²] : 20000
Factor α_s (tabel 7.c EC 7.1) : 0.009 (zandlagen; voor kleilagen zie tabel 7.d)
Factor α_c (tabel 7.c EC 7.1) : 0.0090 (zandlagen; voor kleilagen zie tabel 7.d)
Paalklassefactor α_p : 0.63
Paalvoetvormfactor β : 1.00
Type lastzakkingsdiagram : Grondverdringende paal
Verm.factor * $\phi'_{j,k}$: 1.00
Groutomhulling : JA

PAALGEGEVENS SI Ø762/950

Type : In de grond gevormde geschroefde paal; groutinjectie
Wijze van installeren : Schroeven
Wijze van terugwinnen : n.v.t.
Diameter [m] : 0.860
Elasticiteitsmodulus [N/mm²] : 20000
Factor α_s (tabel 7.c EC 7.1) : 0.009 (zandlagen; voor kleilagen zie tabel 7.d)
Factor α_c (tabel 7.c EC 7.1) : 0.0090 (zandlagen; voor kleilagen zie tabel 7.d)
Paalklassefactor α_p : 0.63
Paalvoetvormfactor β : 1.00
Type lastzakkingsdiagram : Grondverdringende paal
Verm.factor * $\phi'_{j,k}$: 1.00
Groutomhulling : JA

Project : ZWO380 Funderingen
 Onderdeel : RLL-TBG380

OVERZICHT NETTO DRAAGVERMOGEN TREKPALEN (n=1)

Netto paal draagvermogen(s) zijn naar beneden toe afgerond op: 1.0 kN nauwkeurig
 Alle niveaus/hoogtes/peilmaten zijn t.o.v.: N.A.P.

sondering	maalveld niveau	paalpunt niveau	R _{netto;d} [kN]		
			SI Ø508/6	SI Ø610/8	SI Ø762/9
19-1008_1	2.12	-6.00	46		
		-6.50	49		
		-7.00	52	72	
		-7.50	56	76	
		-8.00	67	91	116
		-8.50	80	107	135
		-9.00	85	114	144
		-9.50	105	139	174
		-10.00	123	162	201
		-10.50	144	188	232
		-11.00	158	207	255
		-11.50	183	237	291
		-12.00	213	276	337
		-12.50	234	302	369
		-13.00	267	343	418
		-13.50	300	384	467
		-14.00	328	420	509
		-14.50	365	466	564
		-15.00	399	509	615
		-15.50	436	555	670
		-16.00	468	595	717
		-16.50	503	638	769
		-17.00	539	683	822
		-17.50	580	734	883
		-18.00	626	792	951
		-18.50	672	849	1020
		-19.00	718	907	1088
		-19.50	764	964	1156
		-20.00	822	1036	1242
		-20.50	881	1109	1328
-21.00	942	1185	1418		
-21.50	985	1239	1482		
-22.00	1031	1297	1551		
-22.50	1077	1354	1619		
-23.00	1123	1412	1687		
-23.50	1169	1469	1755		
-24.00	1215	1527	1823		
-24.50	1261	1584	1892		
-25.00	1307	1642	1960		
-25.50	1354	1699	2028		
-26.00	1400	1757	2096		
-26.50	1446	1814	2165		
-27.00	1492	1871	2233		
-27.50	1538	1929	2301		
-28.00	1584	1986	2369		
-28.50	1630	2044	2437		
-29.00	1676	2101	2506		
-29.50	1722	2159	2574		
-30.00	1768	2216	2642		
19-1008_6	11.00	-6.00	392		
		-6.50	438		
		-7.00	485	606	
		-7.50	531	664	
		-8.00	577	721	858
		-8.50	623	779	926
		-9.00	669	836	994
		-9.50	715	894	1063
		-10.00	761	951	1131
		-10.50	807	1009	1199
		-11.00	853	1066	1267
		-11.50	899	1123	1336
		-12.00	945	1181	1404
		-12.50	991	1238	1472
		-13.00	1037	1296	1540
		-13.50	1083	1353	1608
		-14.00	1129	1411	1677
		-14.50	1175	1468	1745
		-15.00	1222	1526	1813
		-15.50	1268	1583	1881
-16.00	1314	1641	1950		
-16.50	1360	1698	2018		
-17.00	1406	1756	2086		
-17.50	1452	1813	2154		
-18.00	1498	1871	2222		
-18.50	1541	1924	2286		
-19.00	1587	1982	2355		
-19.50	1633	2039	2423		
-20.00	1679	2097	2491		
-20.50	1725	2154	2559		
-21.00	1771	2212	2628		
-21.50	1817	2269	2696		
-22.00	1864	2327	2764		
-22.50	1910	2384	2832		
-23.00	1956	2442	2900		
-23.50	2002	2499	2969		
166.S01	3.45	-6.00	231		
		-6.50	277		
		-7.00	323	407	
		-7.50	369	464	

Project : ZWO380 Funderingen
 Onderdeel : RLL-TBG380

Netto paaldragvermogen(s) zijn naar beneden toe afgerond op: 1.0 kN nauwkeurig
 Alle niveaus/hoogtes/peilmaten zijn t.o.v.: N.A.P.

sondering	niveau	maalveld niveau	R _{n, netto;d} [kN]		
			SI Ø508/6	SI Ø610/8	SI Ø762/9
	-8.00		415	521	623
	-8.50		461	579	690
	-9.00		507	636	758
	-9.50		552	692	825
	-10.00		598	749	893
	-10.50		644	807	961
	-11.00		690	864	1030
	-11.50		736	922	1098
	-12.00		779	975	1161
	-12.50		815	1020	1215
	-13.00		849	1063	1266
	-13.50		884	1106	1317
	-14.00		923	1156	1376
	-14.50		969	1213	1444
	-15.00		1015	1270	1512
	-15.50		1061	1328	1581
	-16.00		1107	1385	1649
	-16.50		1153	1443	1717
	-17.00		1200	1500	1785
	-17.50		1246	1558	1854
	-18.00		1292	1615	1922
	-18.50		1338	1673	1990
	-19.00		1384	1730	2058
	-19.50		1430	1788	2126
	-20.00		1476	1845	2195
	-20.50		1522	1903	2263
	-21.00		1568	1960	2331
	-21.50		1614	2018	2399
	-22.00		1660	2075	2468
	-22.50		1706	2133	2536
19-1008_11	0.62	-6.00	159		
		-6.50	163		
		-7.00	169	216	
		-7.50	182	233	
		-8.00	202	258	312
		-8.50	220	280	339
		-9.00	234	298	361
		-9.50	247	316	382
		-10.00	261	333	404
		-10.50	278	354	429
		-11.00	297	378	458
		-11.50	320	407	492
		-12.00	348	442	534
		-12.50	359	457	551
		-13.00	392	498	600
		-13.50	430	546	657
		-14.00	470	595	715
		-14.50	509	644	774
		-15.00	549	693	833
		-15.50	586	740	888
		-16.00	617	779	935
		-16.50	654	825	990
		-17.00	690	870	1043
		-17.50	723	912	1093
		-18.00	765	965	1155
		-18.50	811	1022	1224
		-19.00	858	1079	1292
		-19.50	904	1137	1360
		-20.00	950	1194	1428
		-20.50	996	1252	1497
		-21.00	1042	1309	1565
		-21.50	1085	1364	1629
		-22.00	1131	1421	1698
		-22.50	1178	1479	1766
		-23.00	1220	1531	1828
		-23.50	1248	1567	1871
		-24.00	1284	1612	1925
		-24.50	1325	1663	1985
		-25.00	1364	1712	2043
		-25.50	1397	1753	2092
		-26.00	1444	1811	2161
		-26.50	1490	1869	2230
		-27.00	1536	1926	2298
		-27.50	1582	1984	2366
		-28.00	1628	2041	2434
		-28.50	1674	2099	2502
		-29.00	1720	2156	2571
		-29.50	1766	2214	2639
		-30.00	1812	2271	2707
19-1008_12	3.57	-6.00	419		
		-6.50	455		
		-7.00	500	626	
		-7.50	546	683	
		-8.00	592	740	880
		-8.50	616	771	917
		-9.00	625	781	930
		-9.50	631	790	940
		-10.00	642	804	958
		-10.50	663	831	990
		-11.00	680	852	1015
		-11.50	685	858	1023

Project : ZWO380 Funderingen
 Onderdeel : RLL-TBG380

Netto paal draagvermogen(s) zijn naar beneden toe afgerond op: 1.0 kN nauwkeurig
 Alle niveaus/hoogtes/peilmaten zijn t.o.v.: N.A.P.

sondering	niveau	R _{n, netto;d} [kN]	
		SI Ø508/6	SI Ø610/8 SI Ø762/9
	-12.00	700	878 1047
	-12.50	707	887 1058
	-13.00	713	894 1067
	-13.50	719	903 1078
	-14.00	733	921 1099
	-14.50	751	943 1126
	-15.00	764	959 1146
	-15.50	774	972 1162
	-16.00	790	993 1186
	-16.50	811	1020 1219
	-17.00	829	1042 1246
	-17.50	855	1075 1285
	-18.00	876	1101 1316
	-18.50	921	1158 1383
	-19.00	963	1210 1445
	-19.50	1001	1258 1502
	-20.00	1035	1299 1551
	-20.50	1072	1346 1607
	-21.00	1107	1389 1659
	-21.50	1149	1442 1721
	-22.00	1194	1499 1788
	-22.50	1240	1555 1856
	-23.00	1281	1607 1918
	-23.50	1322	1658 1977
	-24.00	1364	1711 2041
	-24.50	1410	1769 2109
	-25.00	1457	1826 2177
	-25.50	1517	1901 2266
	-26.00	1577	1977 2356
	-26.50	1613	2021 2409
	-27.00	1646	2063 2458
	-27.50	1684	2110 2515
	-28.00	1712	2145 2557
	-28.50	1748	2190 2609
	-29.00	1794	2247 2678
	-29.50	1840	2305 2746
	-30.00	1885	2361 2813
19-1008_17	0.20	-6.00	68
		-6.50	73
		-7.00	98 129
		-7.50	110 144
		-8.00	116 152 188
		-8.50	122 160 198
		-9.00	133 174 216
		-9.50	142 185 229
		-10.00	176 228 280
		-10.50	194 251 307
		-11.00	224 288 352
		-11.50	270 346 420
		-12.00	316 403 488
		-12.50	362 461 556
		-13.00	408 518 625
		-13.50	454 576 693
		-14.00	500 633 761
		-14.50	546 691 829
		-15.00	589 744 893
		-15.50	635 801 961
		-16.00	681 859 1029
		-16.50	727 916 1097
		-17.00	772 972 1163
		-17.50	819 1031 1234
		-18.00	874 1100 1315
		-18.50	912 1146 1370
		-19.00	944 1187 1419
		-19.50	981 1233 1474
		-20.00	1019 1280 1530
		-20.50	1059 1330 1589
		-21.00	1100 1381 1650
		-21.50	1146 1439 1718
		-22.00	1185 1488 1777
		-22.50	1231 1546 1845
		-23.00	1277 1603 1913
		-23.50	1324 1661 1982
		-24.00	1366 1714 2045
		-24.50	1404 1761 2100
		-25.00	1433 1797 2144
		-25.50	1461 1833 2187
		-26.00	1489 1868 2228
		-26.50	1517 1903 2270
		-27.00	1549 1943 2318
		-27.50	1584 1987 2370
		-28.00	1620 2032 2423
		-28.50	1657 2078 2479
		-29.00	1696 2127 2536
		-29.50	1708 2142 2555
		-30.00	1738 2180 2600
19-1008_20	-0.03	-6.00	86
		-6.50	102
		-7.00	131 169
		-7.50	156 201
		-8.00	176 227 276

Project : ZWO380 Funderingen
 Onderdeel : RLL-TBG380

Netto paaldragvermogen(s) zijn naar beneden toe afgerond op: 1.0 kN nauwkeurig
 Alle niveaus/hoogtes/peilmaten zijn t.o.v.: N.A.P.

sondering	maalveld paalpunt		R _{n, netto;d} [kN]		
	niveau	niveau	SI Ø508/6	SI Ø610/8	SI Ø762/9
	-8.50	196	251	306	
	-9.00	222	284	345	
	-9.50	244	312	378	
	-10.00	269	343	416	
	-10.50	276	352	427	
	-11.00	308	393	475	
	-11.50	342	435	526	
	-12.00	350	446	538	
	-12.50	359	457	553	
	-13.00	375	477	576	
	-13.50	383	487	589	
	-14.00	397	505	610	
	-14.50	421	536	647	
	-15.00	449	571	689	
	-15.50	465	591	714	
	-16.00	478	608	733	
	-16.50	495	629	760	
	-17.00	507	644	778	
	-17.50	521	662	799	
	-18.00	546	694	837	
	-18.50	575	730	880	
	-19.00	597	758	913	
	-19.50	626	794	957	
	-20.00	656	832	1002	
	-20.50	694	879	1058	
	-21.00	745	942	1133	
	-21.50	767	971	1167	
	-22.00	782	990	1190	
	-22.50	799	1011	1215	
	-23.00	813	1028	1236	
	-23.50	838	1060	1274	
	-24.00	866	1095	1315	
	-24.50	895	1131	1359	
	-25.00	930	1175	1412	
	-25.50	962	1216	1460	
	-26.00	994	1256	1507	
	-26.50	1023	1292	1550	
	-27.00	1058	1335	1602	
	-27.50	1089	1374	1648	
	-28.00	1116	1409	1690	
	-28.50	1149	1450	1738	
	-29.00	1179	1487	1783	
	-29.50	1204	1518	1820	
	-30.00	1234	1557	1866	
19-1008_21	1.78	-6.00	153		
		-6.50	183		
		-7.00	213	270	
		-7.50	250	316	
		-8.00	284	359	431
		-8.50	319	402	483
		-9.00	337	426	511
		-9.50	352	444	533
		-10.00	373	471	565
		-10.50	392	495	594
		-11.00	413	521	626
		-11.50	439	555	665
		-12.00	469	592	709
		-12.50	492	620	744
		-13.00	518	654	784
		-13.50	547	690	827
		-14.00	590	743	890
		-14.50	632	796	953
		-15.00	664	835	1000
		-15.50	689	867	1037
		-16.00	733	922	1103
		-16.50	778	978	1170
		-17.00	787	990	1184
		-17.50	797	1003	1199
		-18.00	814	1025	1226
		-18.50	863	1085	1298
		-19.00	897	1128	1348
		-19.50	907	1140	1364
		-20.00	915	1151	1377
		-20.50	923	1161	1390
		-21.00	931	1172	1402
		-21.50	940	1184	1417
		-22.00	951	1198	1434
		-22.50	964	1214	1454
		-23.00	976	1230	1473
		-23.50	989	1246	1492
		-24.00	1003	1264	1514
		-24.50	1017	1282	1536
		-25.00	1033	1301	1559
		-25.50	1048	1322	1583
		-26.00	1064	1341	1607
		-26.50	1078	1359	1628
		-27.00	1092	1377	1650
		-27.50	1106	1395	1672
		-28.00	1121	1414	1695
		-28.50	1137	1434	1718
		-29.00	1152	1453	1742
		-29.50	1167	1473	1766

Project : ZWO380 Funderingen
 Onderdeel : RLL-TBG380

Netto paaldragvermogen(s) zijn naar beneden toe afgerond op: 1.0 kN nauwkeurig
 Alle niveaus/hoogtes/peilmaten zijn t.o.v.: N.A.P.

sondering	niveau	maalveld niveau	R _{n, netto;d} [kN]		
			SI Ø508/6	SI Ø610/8	SI Ø762/9
		-30.00	1184	1494	1791
251.S01	-1.05	-6.00	184		
		-6.50	216		
		-7.00	253	322	
		-7.50	289	367	
		-8.00	323	409	492
		-8.50	346	437	526
		-9.00	350	444	534
		-9.50	372	471	566
		-10.00	403	510	613
		-10.50	440	556	668
		-11.00	468	591	710
		-11.50	486	614	737
		-12.00	504	636	764
		-12.50	532	672	807
		-13.00	566	715	858
		-13.50	599	755	905
		-14.00	642	810	971
		-14.50	686	864	1035
		-15.00	733	923	1105
		-15.50	755	951	1138
		-16.00	798	1004	1202
		-16.50	844	1062	1270
		-17.00	890	1119	1337
		-17.50	933	1173	1402
		-18.00	974	1225	1463
		-18.50	1020	1282	1531
		-19.00	1049	1317	1574
		-19.50	1079	1355	1619
		-20.00	1115	1400	1672
		-20.50	1165	1463	1746
		-21.00	1218	1528	1824
		-21.50	1240	1557	1858
		-22.00	1249	1568	1871
		-22.50	1259	1581	1888
		-23.00	1275	1601	1911
		-23.50	1295	1626	1942
		-24.00	1321	1659	1981
		-24.50	1345	1689	2018
		-25.00	1367	1717	2051
		-25.50	1406	1765	2108
		-26.00	1461	1834	2190
		-26.50	1516	1902	2270
		-27.00	1562	1960	2339
		-27.50	1608	2017	2407
		-28.00	1654	2075	2475
		-28.50	1700	2132	2543
		-29.00	1746	2190	2612
		-29.50	1778	2229	2659
		-30.00	1815	2276	2714
19-1008_29	0.79	-6.00	277		
		-6.50	310		
		-7.00	348	438	
		-7.50	388	487	
		-8.00	430	540	645
		-8.50	472	592	707
		-9.00	509	638	762
		-9.50	543	681	813
		-10.00	575	722	861
		-10.50	613	768	916
		-11.00	650	815	971
		-11.50	691	866	1032
		-12.00	711	891	1063
		-12.50	754	945	1127
		-13.00	787	987	1176
		-13.50	802	1005	1198
		-14.00	819	1027	1224
		-14.50	831	1042	1243
		-15.00	842	1056	1260
		-15.50	854	1072	1279
		-16.00	884	1110	1324
		-16.50	896	1125	1343
		-17.00	908	1140	1361
		-17.50	925	1161	1387
		-18.00	964	1210	1444
		-18.50	1010	1267	1512
		-19.00	1055	1324	1580
		-19.50	1090	1368	1632
		-20.00	1136	1425	1700
		-20.50	1182	1483	1768
		-21.00	1228	1540	1836
		-21.50	1275	1598	1905
		-22.00	1321	1655	1973
		-22.50	1374	1721	2052
		-23.00	1414	1772	2112
		-23.50	1442	1807	2154
		-24.00	1475	1848	2202
		-24.50	1508	1890	2252
		-25.00	1543	1934	2304
		-25.50	1566	1962	2338
		-26.00	1591	1994	2376

Project : ZWO380 Funderingen
 Onderdeel : RLL-TBG380

Netto paal draagvermogen(s) zijn naar beneden toe afgerond op: 1.0 kN nauwkeurig
 Alle niveaus/hoogtes/peilmaten zijn t.o.v.: N.A.P.

sondering	maalveld niveau	paalpunt niveau	R _{n, netto;d} [kN]		
			SI Ø508/6	SI Ø610/8	SI Ø762/9
		-26.50	1615	2024	2412
		-27.00	1645	2061	2456
		-27.50	1668	2090	2491
		-28.00	1690	2118	2524
		-28.50	1712	2146	2558
		-29.00	1736	2176	2594
		-29.50	1774	2223	2649
		-30.00	1806	2264	2698
283.S02	0.17	-6.00	224		
		-6.50	252		
		-7.00	284	359	
		-7.50	310	392	
		-8.00	336	424	509
		-8.50	367	463	555
		-9.00	395	498	597
		-9.50	420	529	634
		-10.00	447	563	675
		-10.50	473	596	714
		-11.00	499	629	753
		-11.50	527	663	794
		-12.00	545	686	822
		-12.50	575	725	867
		-13.00	609	767	918
		-13.50	647	814	973
		-14.00	691	869	1039
		-14.50	735	924	1104
		-15.00	774	973	1163
		-15.50	808	1016	1214
		-16.00	846	1062	1269
		-16.50	887	1114	1330
		-17.00	931	1169	1395
		-17.50	977	1226	1464
		-18.00	1023	1284	1532
		-18.50	1069	1341	1600
		-19.00	1115	1399	1668
		-19.50	1161	1456	1736
		-20.00	1207	1514	1805
		-20.50	1251	1569	1870
		-21.00	1298	1626	1938
		-21.50	1344	1684	2007
		-22.00	1390	1741	2075
		-22.50	1436	1799	2143
		-23.00	1482	1856	2211
		-23.50	1528	1913	2279
		-24.00	1574	1971	2348
		-24.50	1620	2028	2416
		-25.00	1666	2086	2484
		-25.50	1712	2143	2552
		-26.00	1758	2201	2621
		-26.50	1808	2262	2694
		-27.00	1825	2285	2721
		-27.50	1842	2307	2747
		-28.00	1863	2333	2778
		-28.50	1890	2366	2818
		-29.00	1909	2390	2847
		-29.50	1926	2411	2872
		-30.00	1942	2432	2897
19-1008_35	0.92	-6.00	245		
		-6.50	266		
		-7.00	283	357	
		-7.50	300	379	
		-8.00	324	409	490
		-8.50	348	439	527
		-9.00	367	463	555
		-9.50	386	487	583
		-10.00	408	515	617
		-10.50	430	542	649
		-11.00	465	586	702
		-11.50	495	624	747
		-12.00	517	651	779
		-12.50	535	674	808
		-13.00	560	705	844
		-13.50	588	741	887
		-14.00	618	778	931
		-14.50	654	823	985
		-15.00	690	869	1039
		-15.50	727	914	1093
		-16.00	764	961	1149
		-16.50	802	1008	1205
		-17.00	835	1049	1254
		-17.50	863	1084	1295
		-18.00	899	1130	1350
		-18.50	932	1171	1399
		-19.00	969	1218	1454
		-19.50	1006	1264	1509
		-20.00	1044	1311	1565
		-20.50	1090	1369	1634
		-21.00	1136	1426	1702
		-21.50	1182	1484	1770
		-22.00	1227	1540	1837
		-22.50	1273	1597	1905

Project : ZWO380 Funderingen
 Onderdeel : RLL-TBG380

Netto paaldragvermogen(s) zijn naar beneden toe afgerond op: 1.0 kN nauwkeurig
 Alle niveaus/hoogtes/peilmaten zijn t.o.v.: N.A.P.

sondering	maalveld niveau	paalpunt niveau	R _{n, netto;d} [kN]		
			SI Ø508/6	SI Ø610/8	SI Ø762/9
		-23.00	1320	1655	1973
		-23.50	1366	1712	2042
		-24.00	1412	1770	2110
		-24.50	1457	1826	2177
		-25.00	1500	1880	2241
		-25.50	1550	1942	2314
		-26.00	1596	2000	2383
		-26.50	1637	2051	2443
		-27.00	1683	2108	2512
		-27.50	1729	2166	2580
		-28.00	1775	2223	2648
		-28.50	1821	2280	2716
		-29.00	1867	2338	2785
		-29.50	1913	2395	2853
		-30.00	1959	2453	2921
312.S03	3.78	-6.00	291		
		-6.50	326		
		-7.00	367	461	
		-7.50	393	493	
		-8.00	421	528	631
		-8.50	467	586	699
		-9.00	513	643	767
		-9.50	559	700	835
		-10.00	605	758	903
		-10.50	651	815	971
		-11.00	694	870	1036
		-11.50	740	927	1104
		-12.00	787	985	1173
		-12.50	833	1042	1241
		-13.00	877	1098	1307
		-13.50	911	1140	1357
		-14.00	948	1186	1412
		-14.50	985	1233	1467
		-15.00	1021	1278	1521
		-15.50	1058	1324	1576
		-16.00	1094	1369	1630
		-16.50	1132	1416	1685
		-17.00	1166	1459	1736
		-17.50	1193	1493	1777
		-18.00	1223	1530	1821
		-18.50	1259	1575	1875
		-19.00	1297	1623	1932
		-19.50	1336	1672	1990
		-20.00	1374	1720	2047
		-20.50	1408	1762	2097
		-21.00	1445	1808	2152
		-21.50	1479	1851	2203
		-22.00	1518	1899	2260
		-22.50	1563	1955	2327
		-23.00	1608	2012	2394
		-23.50	1652	2067	2459
		-24.00	1693	2117	2519
		-24.50	1739	2175	2587
		-25.00	1785	2232	2656
		-25.50	1828	2286	2720
		-26.00	1867	2335	2778
		-26.50	1912	2391	2845
		-27.00	1957	2447	2911
		-27.50	1983	2479	2950
		-28.00	2003	2505	2980
		-28.50	2019	2525	3004
		-29.00	2034	2544	3028
		-29.50	2052	2567	3055
		-30.00	2076	2597	3090
19-1008_43	9.88	-6.00	224		
		-6.50	244		
		-7.00	280	353	
		-7.50	315	397	
		-8.00	351	442	529
		-8.50	385	484	579
		-9.00	419	527	631
		-9.50	455	572	683
		-10.00	487	612	732
		-10.50	526	661	789
		-11.00	572	718	857
		-11.50	618	775	926
		-12.00	664	833	994
		-12.50	710	890	1062
		-13.00	744	933	1113
		-13.50	774	970	1157
		-14.00	808	1014	1209
		-14.50	846	1060	1264
		-15.00	878	1101	1313
		-15.50	919	1152	1373
		-16.00	963	1207	1439
		-16.50	1009	1264	1507
		-17.00	1055	1322	1575
		-17.50	1100	1377	1641
		-18.00	1140	1428	1701
		-18.50	1176	1473	1755
		-19.00	1213	1519	1809

Project : ZWO380 Funderingen
 Onderdeel : RLL-TBG380

Netto paaldragvermogen(s) zijn naar beneden toe afgerond op: 1.0 kN nauwkeurig
 Alle niveaus/hoogtes/peilmaten zijn t.o.v.: N.A.P.

sondering	niveau	maalveld paalpunt		R _{n, netto;d} [kN]		
		niveau	niveau	SI Ø508/6	SI Ø610/8	SI Ø762/9
		-19.50	1242		1556	1853
		-20.00	1273		1594	1899
		-20.50	1311		1642	1956
		-21.00	1356		1697	2021
		-21.50	1392		1743	2076
		-22.00	1434		1795	2138
		-22.50	1480		1852	2206
		-23.00	1526		1910	2274
		-23.50	1572		1967	2342
		-24.00	1618		2025	2411
		-24.50	1664		2082	2479
		-25.00	1703		2131	2537
328.S02	10.17	-6.00	371			
		-6.50	408			
		-7.00	434	543		
		-7.50	466	584		
		-8.00	502	629	749	
		-8.50	539	675	804	
		-9.00	575	720	857	
		-9.50	605	758	903	
		-10.00	640	802	955	
		-10.50	676	847	1009	
		-11.00	718	899	1070	
		-11.50	760	952	1133	
		-12.00	801	1003	1194	
		-12.50	839	1050	1250	
		-13.00	875	1095	1304	
		-13.50	912	1142	1359	
		-14.00	949	1188	1414	
		-14.50	985	1233	1468	
		-15.00	1023	1280	1524	
		-15.50	1060	1327	1579	
		-16.00	1097	1373	1634	
		-16.50	1135	1421	1691	
		-17.00	1182	1478	1759	
		-17.50	1228	1536	1827	
		-18.00	1280	1601	1905	
		-18.50	1314	1643	1955	
		-19.00	1355	1695	2017	
		-19.50	1400	1750	2082	
		-20.00	1446	1808	2150	
		-20.50	1492	1865	2219	
		-21.00	1538	1923	2287	
		-21.50	1584	1980	2355	
		-22.00	1630	2038	2423	
		-22.50	1676	2095	2492	
		-23.00	1722	2153	2560	
		-23.50	1768	2210	2628	
		-24.00	1814	2267	2696	
		-24.50	1853	2316	2754	
		-25.00	1890	2363	2810	
		-25.50	1927	2409	2864	
		-26.00	1964	2455	2920	
		-26.50	2004	2504	2978	
		-27.00	2050	2562	3046	
		-27.50	2096	2619	3114	
		-28.00	2135	2668	3172	
		-28.50	2169	2711	3223	

APPENDIX E

Berekening horizontale afdracht

In deze Appendix wordt de horizontale krachtsafdracht van de enkelpaalsfundering aangetoond.

Schematisering

De constructie wordt geschematiseerd als een elastisch ondersteunde ligger met begrensde beddingweerstand tot de passieve gronddruk met dwarsbelasting op de paalkop.

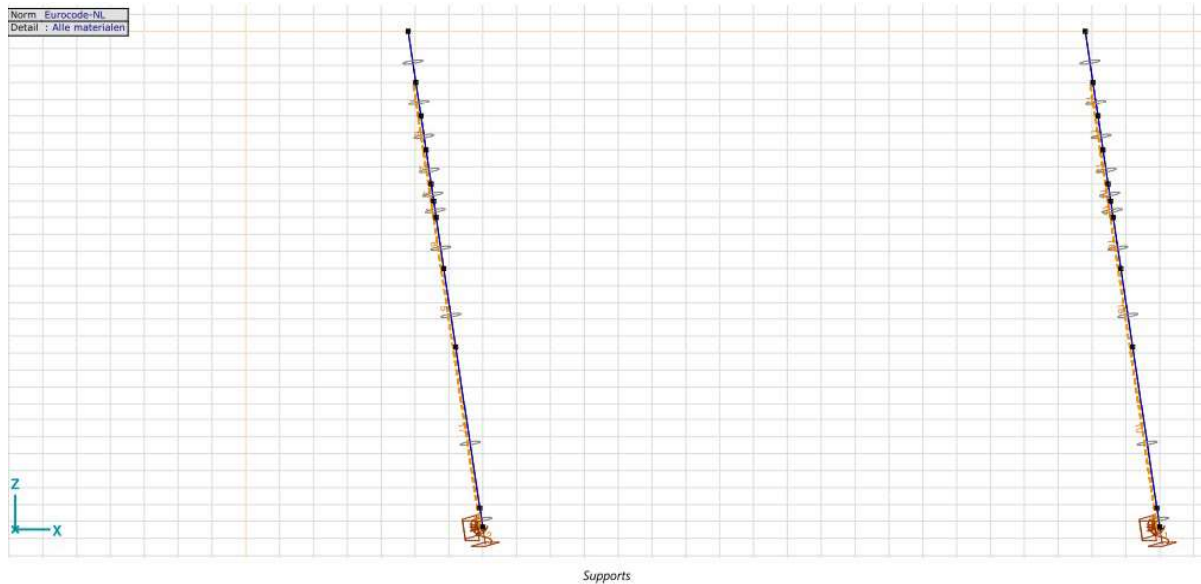

Figuur 10 Rekenmodel

In paragraaf 2.8.6 zijn de uitgangspunten gegeven voor de beddingen tegen de palen. Er is in het kader van de berekening voldoende nauwkeurigheid als onderscheid wordt gemaakt in beddingwaarde voor drie grondsoorten. Er zijn twee berekeningen uitgevoerd: een met lage veerwaarde (k gedeeld door $\sqrt{2}$) en een met hoge veerwaarde (k maal $\sqrt{2}$).

Tabel 16 Beddingwaarden

Paal	Grond	k_h [kN/m ³]	schelp [-]	Diameter [m]	Gem. [kN/m]	Laag [kN/m]	Hoog [kN/m]
Ø610/850	Veen	1500	1,2	0,61	1098	776	1553
	Klei	3000	1,3	0,61	2379	1682	3364
	Zand	15000	2,0	0,85	25500	18031	36062

Het maatgevende bodemprofiel van sondering 2019-1008-17 is gebruikt, zie Tabel 16.

Tabel 17 Gehanteerd bodemprofiel

Van [m]	Tot [m]	Omschrijving
0,0	-4,5	Klei
-4,5	-5,0	Zand
-5,0	-6,5	Klei
-6,5	-30,0	Zand

De maximale weerstand die in rekening mag worden gebracht kan niet groter zijn dan de passieve gronddruk. Over de bovenste meters waar de grootste verplaatsingen optreden, is vanuit die overweging de maximale reactie van de lijnondersteuning aan de paal in de berekening begrensd. Er is uitgegaan van een volumiek gewicht van 17 kN/m³, een grondwaterstand van 0,5 m beneden maaiveld.

De methode van Bijlage C van NEN 1997-1 is gevolgd. De factor voor passieve gronddruk is voor klei of veen op 2 aangehouden, voor zand op 3. Onderstaand zijn de maximale grondweerstand samengevat die zijn toegekend aan de elastische ondersteuning van de palen.

Tabel 18 Begrenzing passieve gronddruk

Paal	Grond	Niveau [m]	p [kN/m ³]	k _{pa} [kN/m ³]	schelp [-]	Diameter [m]	Max. druk [kN]	Max. druk [kN] 50%
Ø610	Klei	0	0					
		-1	12	2	1,3	0,61	9,5	4,8
		-2	19	2	1,3	0,61	24,6	12,3
		-3	26	2	1,3	0,61	35,7	17,8

Belasting

De belastingen zijn ontleend aan PLS-TOWER en opgenomen in Appendix A. De belastingen in de lokale richting van de paal zijn ingevoerd.

De belastingen van masttype S+12_c, S+18_s, S+24_s onderscheiden zich door een hoge "spatkracht" naar buiten in combinatie met extreme trek of drukbelasting. De belasting is zodanig dat dit tot te grote verplaatsingen leidt bij het maatgevende grondprofiel. Voor deze masttypes is voor het DO uitgaan van een tweepaalspoer. De maatgevende mast ten aanzien van horizontale belastingen over de overige masttypes is S+3_c, zie hiervoor het blad "trekbelasting lokaal" in Appendix A. In combinatie max. trek is de combinatie van Reta en R_{xi,lok} het grootst. De groen gearceerde belastingen zijn in AxisVM ingevoerd.

Tabel 19 Belastingen S+3_c

Belasting	Combinatie	R _x [kN]	R _y [kN]	R _z [kN]	R _n [kN]	R _t [kN]	R _{t,lok} [kN]	R _{z,lok} [kN]
Max. druk	ULS 1a_45	-274	-267	-1838	5	-382	-8	-1878
Max. trek	ULS 1a_0,9_0,9_90	222	-175	1433	33	281	23	1461
Max. pos. torsie	ULS 5a Ah 11_bouwfase	13	-97	-364	59	-78	1	-372
Max. neg. torsie	ULS 5a Ba 11_bouwfase	-13	-97	-364	-59	-78	1	-372
Comb. trek+torsie	ULS 1a_0,9_0,9_90	222	-175	1433	33	281	23	1461

Toetsing

De volgende aspecten zijn getoetst:

- Horizontale verplaatsing < 1/400 x b
- Buigspanning in de paal < f_y

De gronddruk wordt niet getoetst, deze is immers reeds begrensd.

Verplaatsingseisen worden gesteld voor de karakteristieke belastingen, zonder belastingfactoren. In de berekening is gewerkt met rekenwaarden. Als de berekening wordt uitgevoerd met belastingfactor (ULS of SpLS) moet om terug te rekenen worden gedeeld door de belastingfactor. De methode wordt hier toegelicht.

Er wordt gerekend met een verhouding ULS/SLS van 1,35. Voor de load case ULS-5a met maximale torsiebelasting wordt een factor 1,0 gerekend aangezien de belastingfactor in dat geval 1,0 bedraagt.

Onder de belasting door torsie verplaatsen beide poten in dezelfde richting, theoretisch wordt dan altijd voldaan aan de eis. Gekozen is om ook hier het uitgangspunt te hanteren van 1/400 x b. In de overige load cases met maximale wind (ULS-1a) kunnen beide poten tegengesteld vervormen. De toelaatbare vervorming is in die gevallen 50% van de toelaatbare waarde. De eisen zijn in Tabel 19 samengevat. De pootspreiding van maatgevende mast S+3_c is gebruikt.

Tabel 20 Toelaatbare horizontale belasting

Mast	Basiseis		Eis voor berekeningsresultaten			
	b [m]	eis [-]	Eis [mm]	Factor 1 [-]	Factor 2 [-]	Eis [mm]
Extr. wind load cases		10,24	1/400	25,6	1,35	0,50
Torsie load case		10,24	1/400	25,6	1,00	1,00

Resultaten

Zie berekening AxisVM:

Tabel 21 Resultaten

	Berekend	Toelaatbaar	Unity-check
Spanningscheck buispaal	121	355 N/mm ²	0,34 OK
Verplaatsing ULS-1a ex/ey	15,4	17,3 mm	0,89 OK
Verplaatsing ULS-5a ex/ey	20,8	25,6 mm	0,81 OK

Conclusie: de enkelpaalsfundering voldoet.

Bijlage: rapport AxisVM

Project

Analysis by

AxisVM X6 R11 - Geregistreerd aan DNV GL - Energy
ZWO380 20210927 1-p rev1.axs

Report

Onderdeel		Pagina
Geometry		3
Materialen		4
Profielen		4
Soil prop low		5
Soil prop high		6
Veereigenschappen		7
Referenties		7
Supports		8
Max trek		9
Max trek: Knoopbelastingen		10
Max druk		10
Max druk: Knoopbelastingen		11
Max torsie		11
Max torsie, Bovenanzicht		12
Max torsie: Knoopbelastingen [S 355]		13
Trek+torsie		13
Trek+torsie: Knoopbelastingen [S 355]		14
Trek+torsie: Geconcentreerde belastingen op staven [S 355]		14
Gebruiker gedefinieerde belastingcombinaties uit belastinggevallen		14
[II], > S 355, Non-lin., Omhullende (Standaard), Onmiddellijke doorbuiging, My, Lijnen (gevuld), Vooraanzicht		15
[II], > S 355, Non-lin., Omhullende (Standaard), Onmiddellijke doorbuiging, Mz, Lijnen (gevuld), Vooraanzicht		16
[II], > S 355, Non-lin., Omhullende (Standaard), Onmiddellijke doorbuiging, Nx, Lijnen (gevuld), Vooraanzicht		17
[II], > S 355, Non-lin., Omhullende (Standaard), Onmiddellijke doorbuiging, Vy, Lijnen (gevuld), Vooraanzicht		18
[II], > S 355, Non-lin., Omhullende (Standaard), Onmiddellijke doorbuiging, Vz, Lijnen (gevuld), Vooraanzicht		19
Staafkrachten [Non-lin., Omhullende (UGT)]		20
[II], > S 355, Non-lin., Omhullende (Standaard), Onmiddellijke doorbuiging, eX, Lijnen		22
[II], > S 355, Non-lin., Omhullende (Standaard), Onmiddellijke doorbuiging, eY, Lijnen		23
[II], > S 355, Non-lin., Omhullende (Standaard), Onmiddellijke doorbuiging, eZ, Lijnen, Vooraanzicht		24
[II], > S 355, Non-lin., Co #1 [1] (1,000), Onmiddellijke doorbuiging, eY, Lijnen		25
[II], > S 355, Non-lin., Co #3 [1] (1,000), Onmiddellijke doorbuiging, eY, Lijnen		26
Knoopverplaatsingen [Non-lin., Omhullende (UGT), S 355]		27
[II], > S 355, Non-lin., Omhullende (Standaard), Onmiddellijke doorbuiging, Rx (knoopopl.), Lijnen, Vooraanzicht		28
[II], > S 355, Non-lin., Omhullende (Standaard), Onmiddellijke doorbuiging, Ry (lijnopp.), Lijnen (gevuld), Vooraanzicht		29
[II], > S 355, Non-lin., Omhullende (Standaard), Onmiddellijke doorbuiging, Rz (lijnopp.), Lijnen (gevuld), Vooraanzicht		30
Interne krachten knooppolegging [Non-lin., Omhullende (Standaard), S 355]		31
[II], > S 355, Non-lin., Omhullende (Standaard), Onmiddellijke doorbuiging, Sominmax, Lijnen (gevuld), Vooraanzicht		32
Staafspanningen [Non-lin., Omhullende (Standaard), S 355]		33

Project

Analysis by

Model: ZWO380 20210927 1-p rev1.axs

14-10-2021

Pag. 3

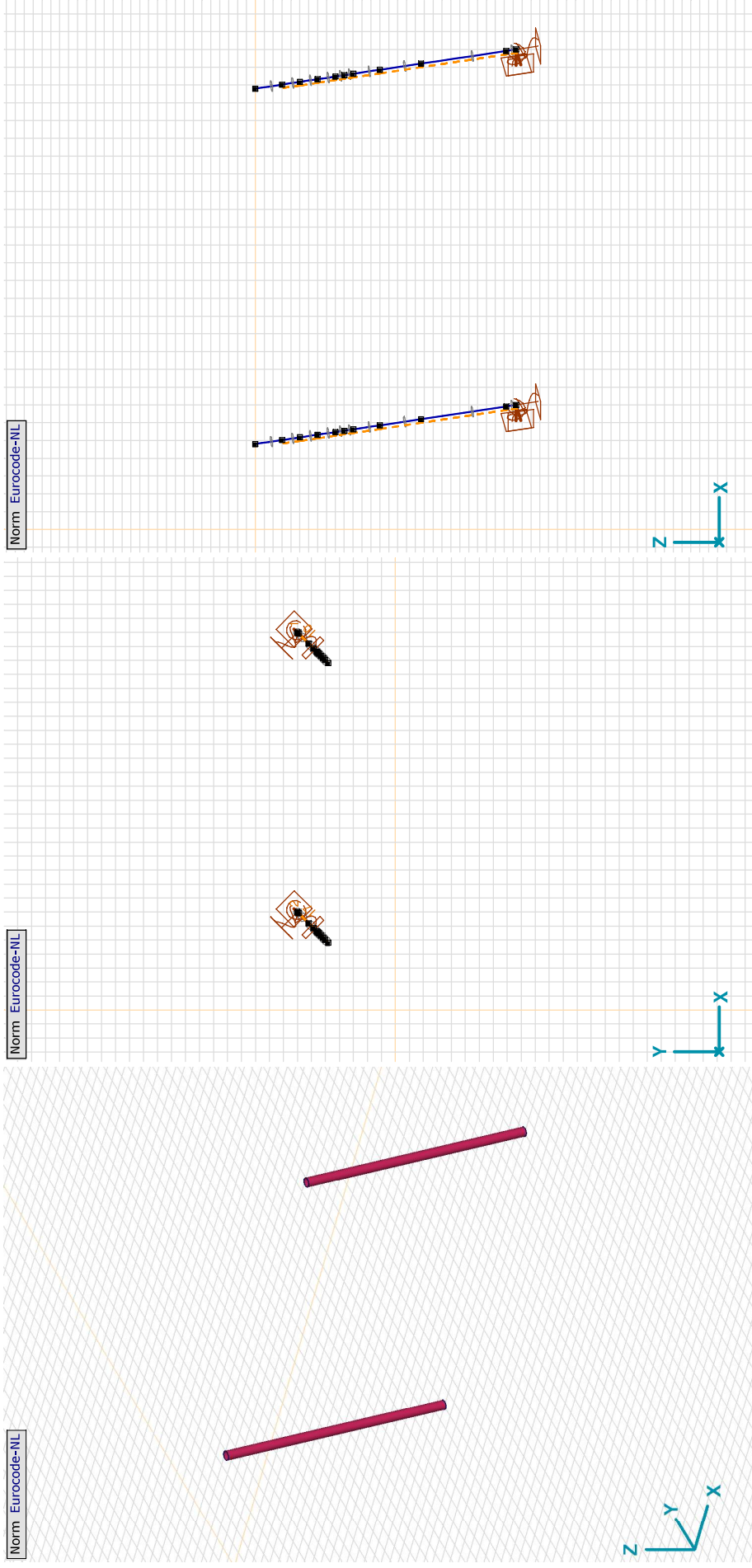

Geometry

Project

Analysis by

Model: ZWO380 20210927 1-p rev1.axs

14-10-2021

Pag. 4

Materialen

Naam	Type	Nationale norm	Materiaalnorm	Model	E_x [N/mm ²]	E_y [N/mm ²]	ν	α_T [1/°C]	ρ [kg/m ³]	Materiaal kleur	Contour kleur	Structuur	P_1
1	S 355	Staal	Eurocode-NL	10025-2	Lineair	210000	210000	0,30	1,2E-5	7850		Steel	f_{yk} [N/mm ²] = 355,00

Naam	P_2	P_3	P_4	P_5	P_6	P_7	P_8	P_9	P_{10}	P_{11}	P_{12}	P_{13}	P_{14}
1	S 355	f_{tk} [N/mm ²] = 510,00	f_{yk} [N/mm ²] = 335,00	f_{t0} [N/mm ²] = 470,00									

Naam: Materiaalnaam; **Type:** Type materiaal; **Model:** Materiaal model; **E_x :** Elasticiteitsmodulus in lokale x richting; **E_y :** Elasticiteitsmodulus in lokale y richting; **ν :** Poisson's verhouding; **α_T :** Warmteuitzettingscoëfficiënt; **ρ :** Dichtheid; **Materiaal kleur:** Materiaalkleur; **Contour kleur:** Contourkleur; **$P_1, P_2, P_3, P_4, P_5, P_6, P_7, P_8, P_9, P_{10}, P_{11}, P_{12}, P_{13}, P_{14}$:** Ontwerpparameter.

Profielen

Naam	Tekening	Productie	Vorm	h [mm]	b [mm]	tw [mm]	tf [mm]	r_1 [mm]	r_2 [mm]	r_3 [mm]	Ax [mm ²]	Ay [mm ²]	Az [mm ²]	Ix [mm ⁴]	Iy [mm ⁴]	Iz [mm ⁴]
1	ROR 610,00* 10,0	Gewalst	Buis	610,0	610,0	10,0	10,0	0	0	0	18825,65	9417,10	9417,19	1,7E+09	8,46E+08	8,46E+08
2	O 610x9	Gewalst	Buis	610,0	610,0	9,2	9,2	0	0	0	17361,19	8683,87	8683,99	1,57E+09	7,83E+08	7,83E+08

Naam	I_yz [mm ⁴]	I_1 [mm ⁴]	I_2 [mm ⁴]	α [°]	$I\omega$ [mm ⁶]	$W_{1,elit}$ [mm ³]	$W_{1,elb}$ [mm ³]	$W_{2,elb}$ [mm ³]	$W_{2,elit}$ [mm ³]	$W_{1,pl}$ [mm ³]	$W_{2,pl}$ [mm ³]	i_y [mm]	i_z [mm]	H_y [mm]	H_z [mm]
1	ROR 610,00* 10,0	0	8,46E+08	8,46E+08	0	0	2774803,00	2774803,00	2774803,00	3593483,00	3593483,00	212,0	212,0	610,0	610,0
2	O 610x9	0	7,83E+08	7,83E+08	0	0	2568402,00	2568402,00	2568402,00	3320086,00	3320108,00	212,4	212,4	610,0	610,0

Naam	Y_G [mm]	Z_G [mm]	Y_s [mm]	Z_s [mm]	β_y [mm]	β_z [mm]	β_w [mm]	S.p.
1	ROR 610,00* 10,0	305,0	305,0	0	0	0	1,8	5
2	O 610x9	305,0	305,0	0	0	0	0	5

Naam: Doorsnede naam; **Productieproces:** Vorm; **Profiel:** h: Doorsnede hoogte; **b :** Doorsnede breedte; **tw :** Lijfdikte; **tf :** Flensdikte; **r_1, r_2, r_3 :** Afrondingswaarde; **Ax :** Doorsnede-oppervlak; **Ay, Az :** Afschuivingsoppervlak; **Ix :** Torietraagheidsmoment; **Iy, Iz :** Buigtraagheidsmoment; **Iyz :** Centrifugaal traagheidsmoment; **I_1, I_2 :** Hoofdbuigtraagheidsmoment; **α :** Hoofdrichtingen; **$I\omega$:** Krommingsconstante; **$W_{1,elit}, W_{1,elb}, W_{2,elit}, W_{2,elb}$:** Elastisch weerstandsmoment; **$W_{1,pl}, W_{2,pl}$:** Plastisch weerstandsmoment; **i_y, i_z :** Traagheidsstraal; **H_y, H_z :** Afmeting in lokale Y-richting; **H_z :** Afmeting in lokale Z-richting; **Y_G :** Y-coördinaat van het zwaartepunt; **Z_G :** Z-coördinaat van het zwaartepunt; **Y_s :** Y-coördinaat van het afschuivingsmiddelpunt (toisie); **Z_s :** Z-coördinaat van het afschuivingsmiddelpunt (toisie); **$\beta_y, \beta_z, \beta_w$:** Wagner's coëfficiënt; **S.p.:** Spanningspunten.

Project

Analysis by

Model: ZWO380 20210927 1-p rev1.axs

14-10-2021

Pag. 5

Norm	Eurocode-NL
Geval	Max torsie
Detail	Alle materialen

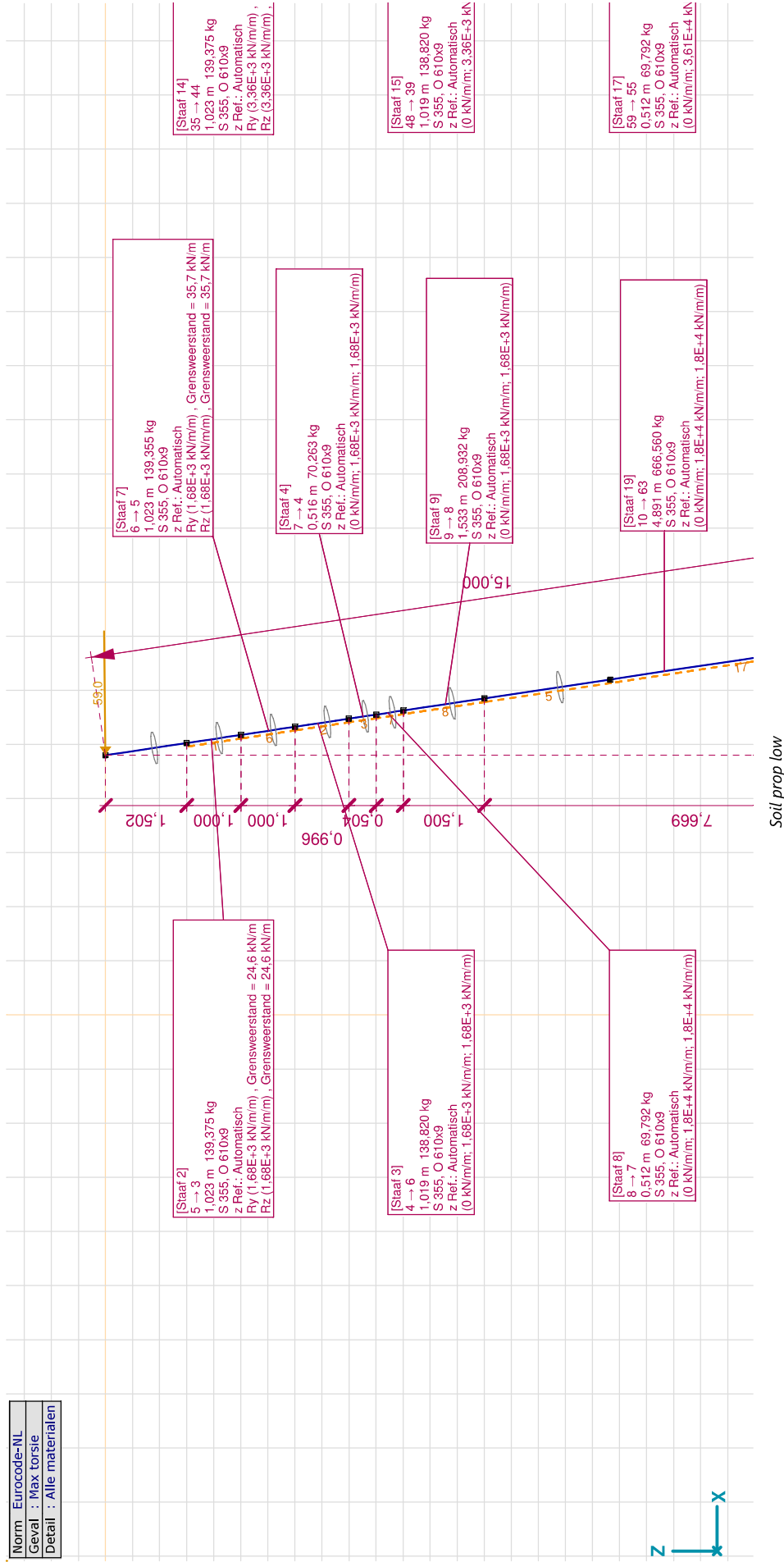

Project

Analysis by

Model: ZWO380 20210927 1-p rev1.axs

14-10-2021

Pag. 6

Norm	Eurocode-NL
Geval	: Max torsie
Detail	: Alle materialen

stand = 35.7 kN/m
stand = 35.7 kN/m

E+3 kN/m(m)

+3 kN/m(m)

Z
+4 kN/m(m)

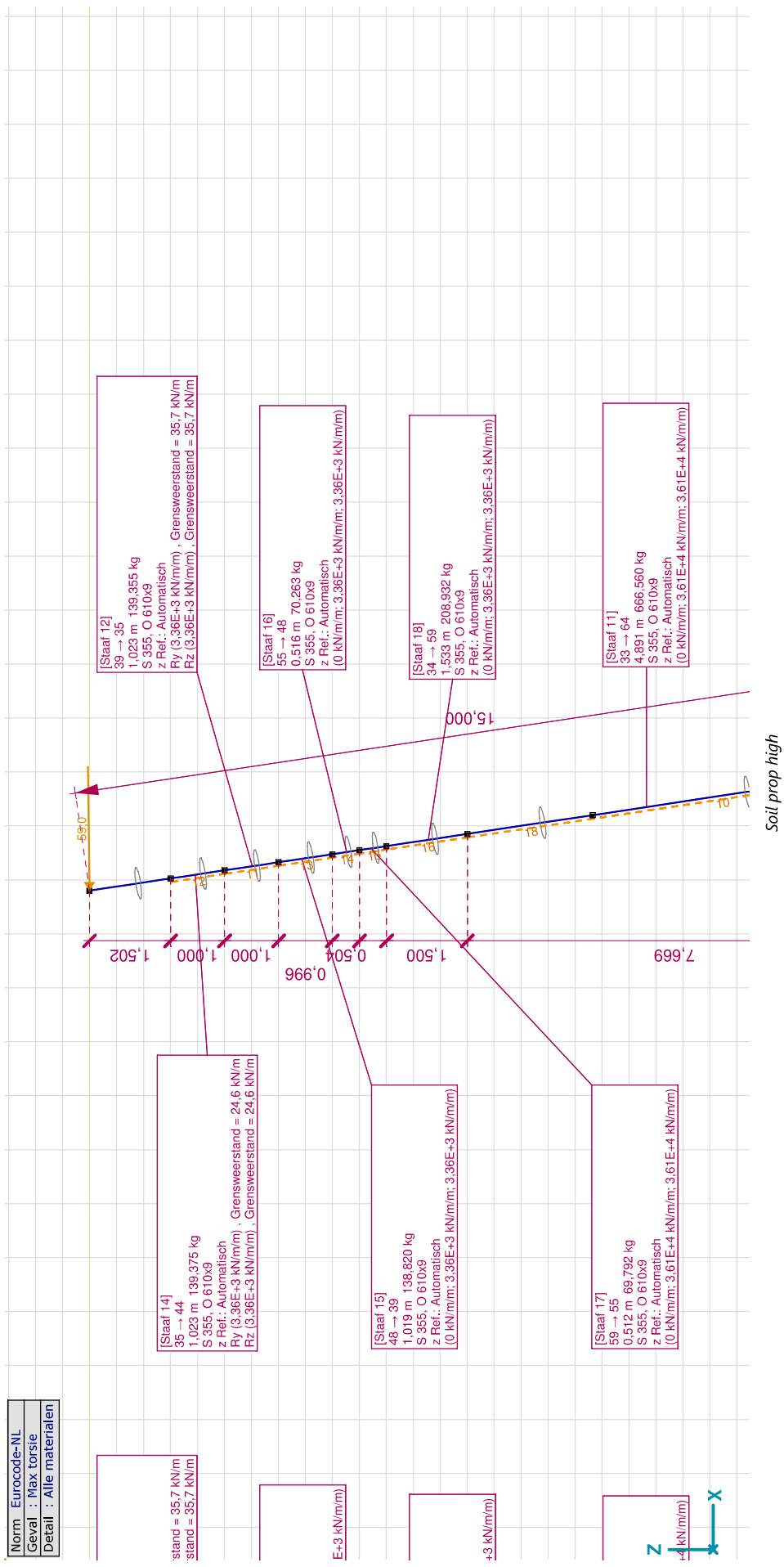

Project

Analysis by

Model: ZWO380 20210927 1-p rev1.axs

14-10-2021

Pag. 7

Veereigenschappen

	Naam	Type	Vrijheidsgraden	Model	K	K_v	NL	Grenswaarde	K_T	K_C
1	Verend - translatie	N-N	translatie	Lineair	1E+0 kN/m	1E+0 kN/m	Symmetrisch	—	1E+0 kN/m	1E+0 kN/m
2	Rigid - Translational	N-N	translatie	Lineair	1E+10 kN/m	1E+10 kN/m	Symmetrisch	—	1E+10 kN/m	1E+10 kN/m
3	Verend - rotatie	N-N	rotatie	Lineair	1E+0 kNm/rad	1E+0 kNm/rad	Symmetrisch	—	1E+0 kNm/rad	1E+0 kNm/rad
4	Vast - rotatie	N-N	rotatie	Lineair	1E+10 kNm/rad	1E+10 kNm/rad	Symmetrisch	—	1E+10 kNm/rad	1E+10 kNm/rad
5	Rigid_comp_only	N-N	translatie	NL elastisch	1E+10 kN/m	1E+10 kN/m	Druk Alleen druk	2415,0 kN	0 kN/m	1E+10 kN/m
6	Linear 5E+2 kNm/rad	N-N	rotatie	Lineair	5E+2 kNm/rad	5E+2 kNm/rad	Symmetrisch	—	5E+2 kNm/rad	5E+2 kNm/rad
7	Linear 1E+1 kNm/rad	N-N	rotatie	Lineair	1E+1 kNm/rad	1E+1 kNm/rad	Symmetrisch	—	1E+1 kNm/rad	1E+1 kNm/rad
8	Linear 1E+5 kN/m	N-N	translatie	Lineair	1E+5 kN/m	1E+5 kN/m	Symmetrisch	—	1E+5 kN/m	1E+5 kN/m
9	Linear 3,3E+5 kN/m	N-N	translatie	Lineair	3,3E+5 kN/m	3,3E+5 kN/m	Symmetrisch	—	3,3E+5 kN/m	3,3E+5 kN/m

Naam: Naam van de veereigenschappen; **Model:** Materiaal model; **K:** Initiële stijfheid; **K_v :** Trillingsstijfheid; **NL:** Niet-lineaire parameters; **K_T :** Initiële stijfheid, onder trek; **K_C :** Initiële stijfheid, onder druk;

Referenties

	Naam	Type	X_1 [m]	Y_1 [m]	Z_1 [m]	X_2 [m]	Y_2 [m]	Z_2 [m]	X_3 [m]	Y_3 [m]	Z_3 [m]
1	R1	Ve	5,571	5,571	0	4,864	6,278	-0,009			
2	R2	Ve	5,571	5,571	0	5,718	5,718	-0,978			
3	R3	Ve	4,800	4,800	0	5,507	5,507	0			

Naam: Referentie naam; **Type:** Type van %s;

Project

Analysis by

Model: ZWO380 20210927 1-p rev1.axs

14-10-2021

Pag. 8

Norm Eurocode-NL
Detail : Alle materialen

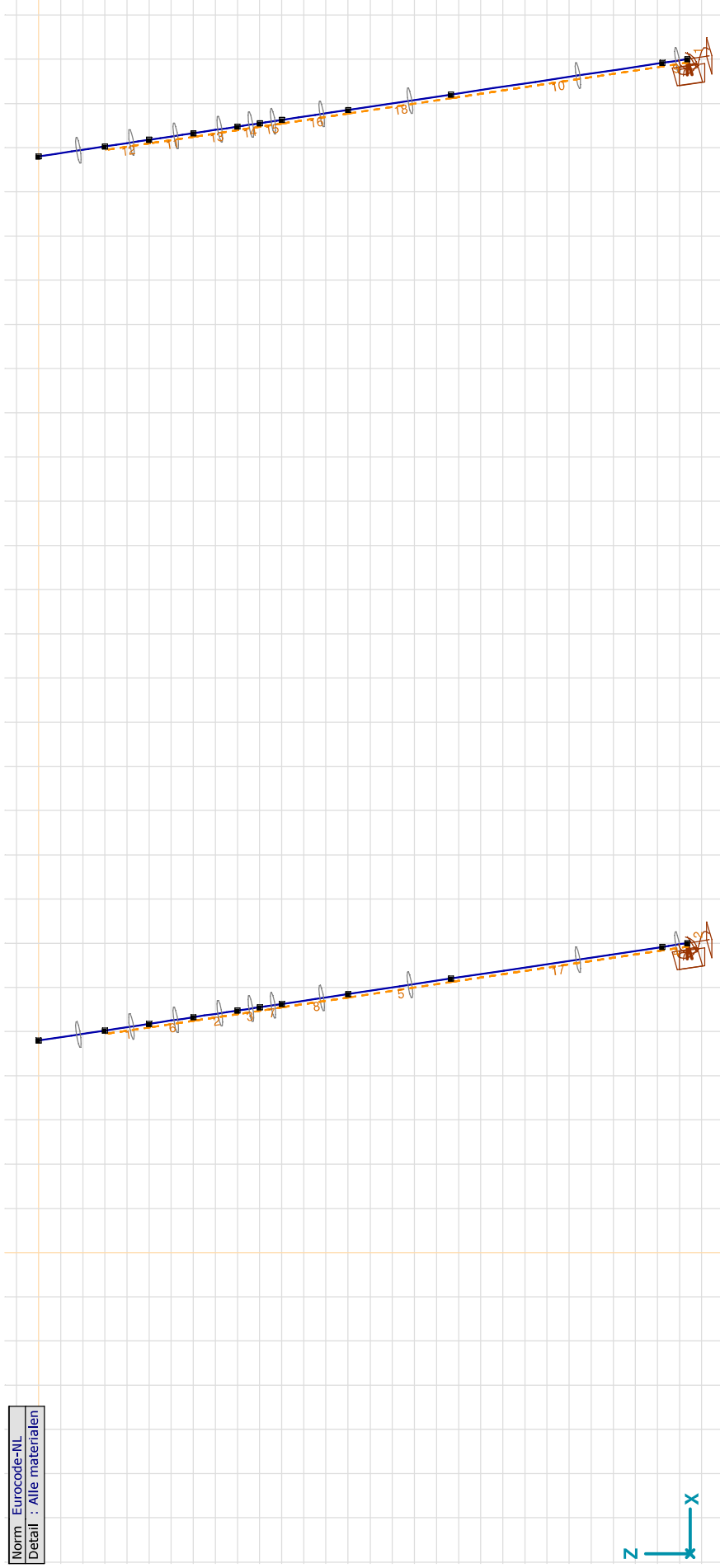

Supports

Project

Analysis by

Model: ZWO380 20210927 1-p rev1.axs

14-10-2021

Pag. 9

Norm	Eurocode-NL
Geval	: Max trek

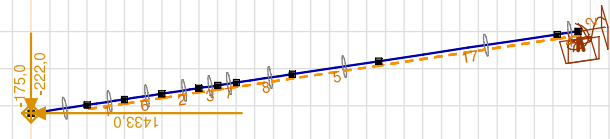

Max trek



Project

Analysis by

Model: **ZWO380 20210927 1-p rev1.axs**

Max trek: Knoopbelastingen

Richting	F _x [kN]	F _y [kN]	F _z [kN]	M _x [kNm]	M _y [kNm]	M _z [kNm]
1	-222,0	-175,0	1433,0	0	0	0
40	-222,0	-175,0	1433,0	0	0	0

F_x, F_y, F_z: Belastingkracht component; M_x, M_y, M_z: Belastingmoment component;

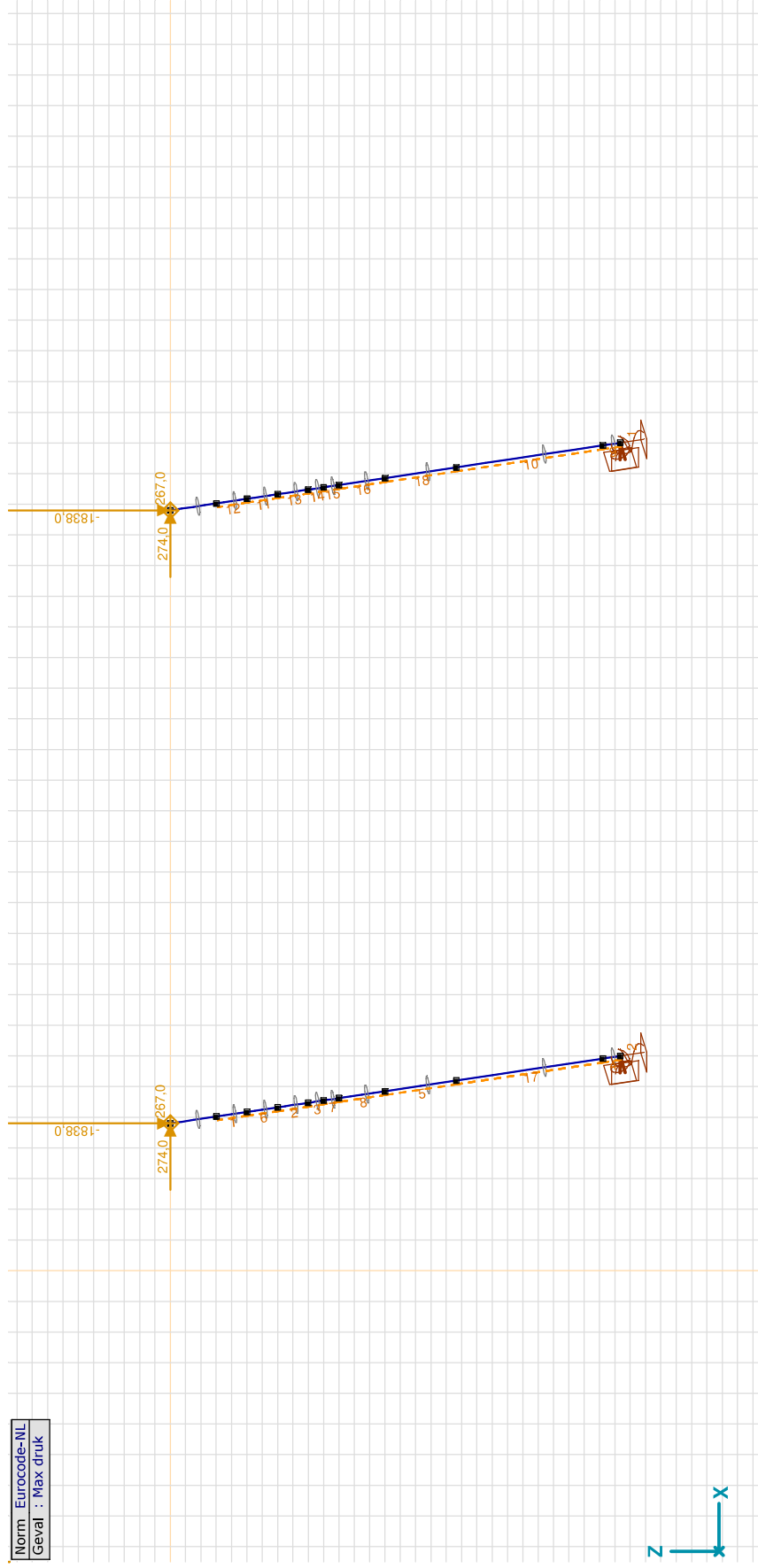

Max druk

Project

Analysis by

Model: **ZWO380 20210927 1-p rev1.axs**

Max druk: Knoopbelastingen

	Richting	Fx [kN]	Fy [kN]	Fz [kN]	Mx [kNm]	My [kNm]	Mz [kNm]
1	Globaal	274,0	267,0	-1838,0	0	0	0
40	Globaal	274,0	267,0	-1838,0	0	0	0

Fx, Fy, Fz: Belastingkracht component; Mx, My, Mz: Belastingmoment component;

Norm Eurocode-NL
Geval : Max torsie

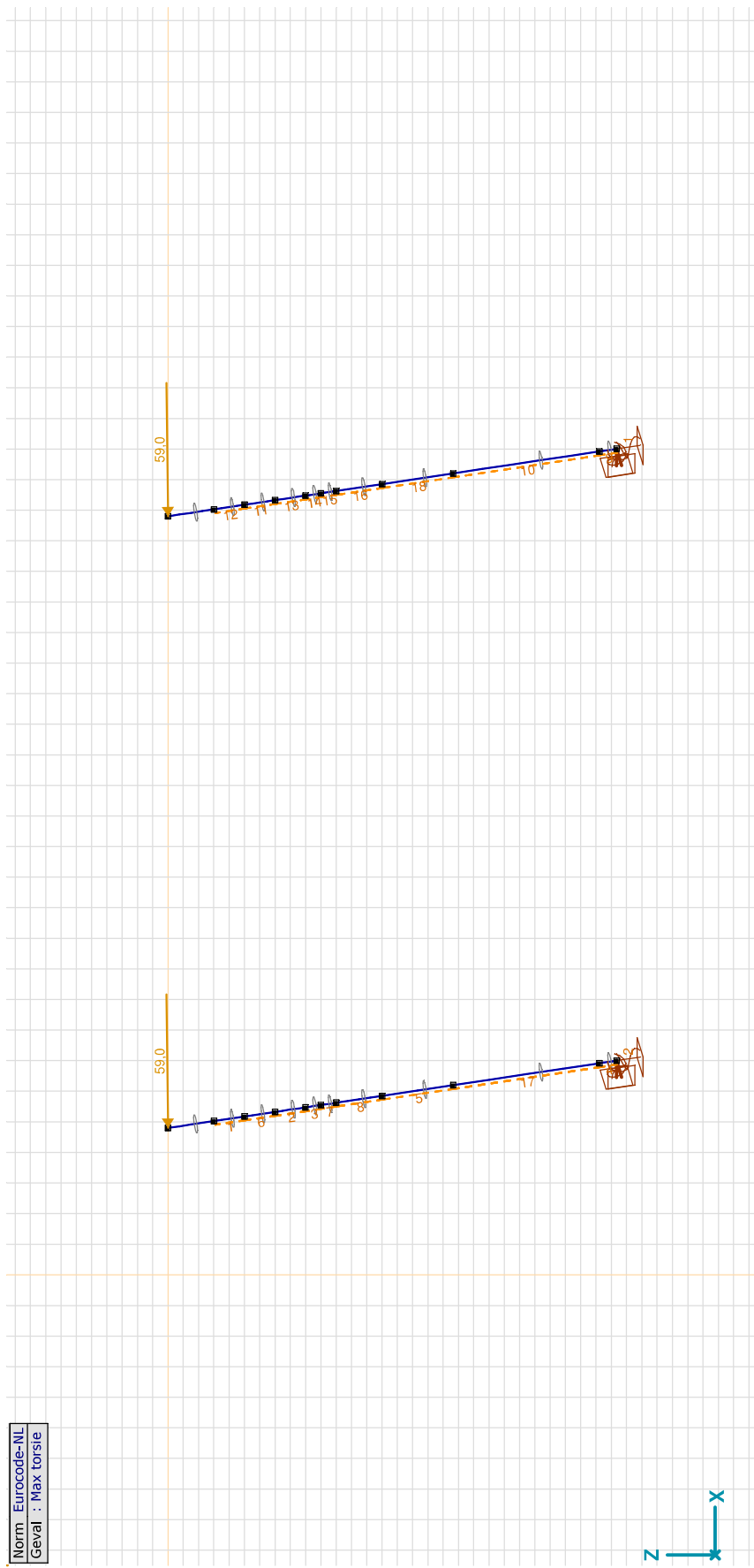

Max torsie

Project

Analysis by

Model: ZWO380 20210927 1-p rev1.axs

14-10-2021

Pag. 12

Norm Eurocode-NL
Geval : Max torsie

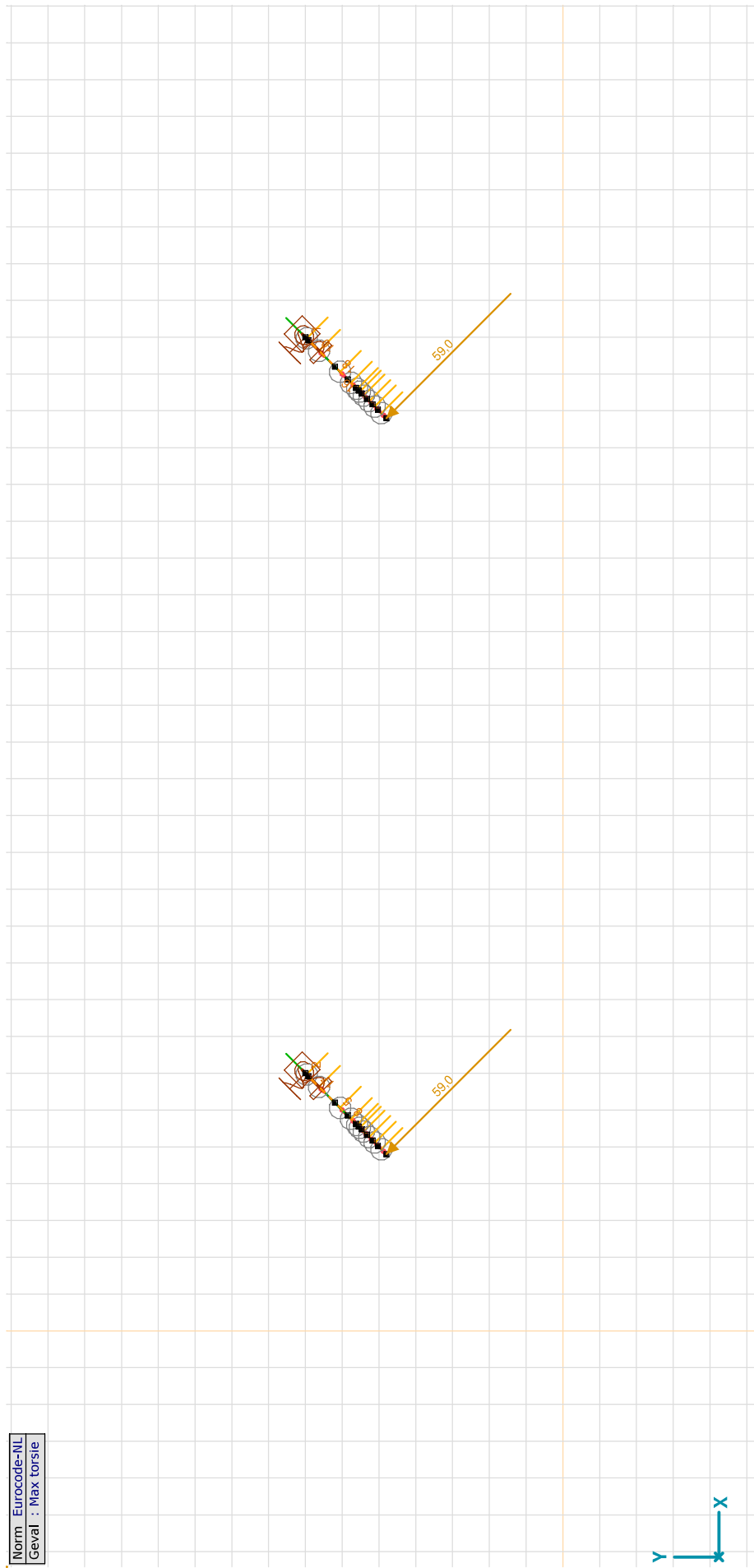

Max torsie, Bovenaanzicht

Project

Analysis by

Model: **ZWO380 20210927 1-p rev1.axs**

Max torsie: Knoopbelastingen [S 355]

	Richting	F _x [kN]	F _y [kN]	F _z [kN]	M _x [kNm]	M _y [kNm]	M _z [kNm]
1	R1	59,0			0		
40	R1	59,0			0		

F_x, F_y, F_z: Belastingkracht component; M_x, M_y, M_z: Belastingmoment component;

Norm Eurocode-NL
Geval : Trek+torsie

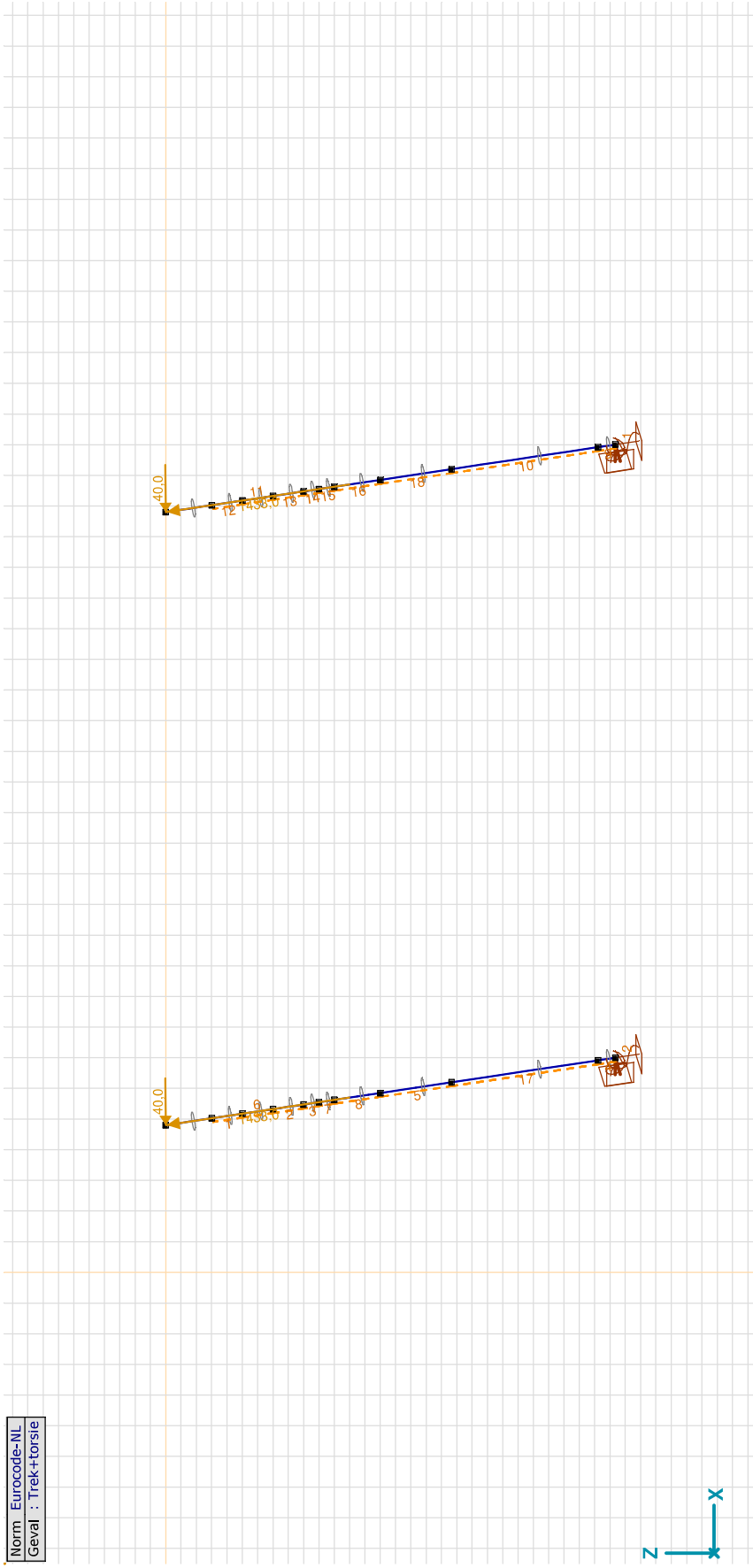

Trek+torsie

Project

Analysis by

Model: **ZWO380 20210927 1-p rev1.axs**

14-10-2021

Pag. 14

Trek+torsie: Knoopbelastingen [S 355]

Richting	F _x [kN]	F _y [kN]	F _z [kN]	M _x [kNm]	M _y [kNm]	M _z [kNm]
1	40,0			0		
40	40,0			0		

F_x, F_y, F_z: Belastingkracht component; **M_x, M_y, M_z**: Belastingmoment component;**Trek+torsie: Gecentreerde belastingen op staven [S 355]**

Type	Lengte [m]	a/d	Pos.	F _x [kN]	F _y [kN]	F _z [kN]	M _x [kNm]	M _y [kNm]	M _z [kNm]	Excentriciteit	e _y [mm]	e _z [mm]
1	Staaf L	1,535	d	1,500	1433,0	0	0	0	0	Geen excentriciteit		
13	Staaf L	1,535	d	1,500	1433,0	0	0	0	0	Geen excentriciteit		

Type: Belastingtype; **Lengte**: Elementlengte; **a/d**: Positie als verhouding (a) of lengte (d); **Pos.**: Positie; **F_x, F_y, F_z**: Belastingkracht component; **M_x, M_y, M_z**: Belastingmoment component;**Gebruiker gedefinieerde belastingcombinaties uit belastinggevallen**

Naam	Type	Max trek	Max druk	Max torsie	Trek+torsie	Commentaar
1	Co #1	UGT	1,00	0	0	
2	Co #2	UGT	0	1,00	0	
3	Co #3	UGT	0	0	1,00	
4	Co #4	UGT	0	0	0	1,00

Naam: Naam belastingcombinatie; **Type**: Type belastingcombinatie; **Max trek, Max druk, Max torsie, Trek+torsie**: Factor;

Project

Analysis by

Model: ZWO380 20210927 1-p rev1.axs

14-10-2021

Pag. 15

Niet-lineaire berekening	
Norm	Eurocode-NL
Geval	: Omhullende Min, Max
Omhullende	: Standaard
E (U)	: 1,85E-7
E (P)	: 7,46E-9
E (W)	: 7,53E-16
E (Eq)	: 4,24E-11
Comp.	: My [kNm]
Detail Max	: 24,3
Detail Min	: -55,3
Detail	: Alle materialen

My [kNm]	24,3
	18,6
	12,9
	7,2
	1,5
	-4,1
	-9,8
	-15,5
	-21,2
	-26,9
	-32,6
	-38,3
	-44,0
	-49,6
	-55,3

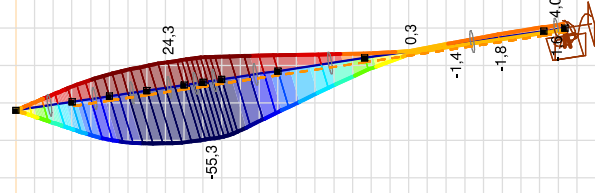
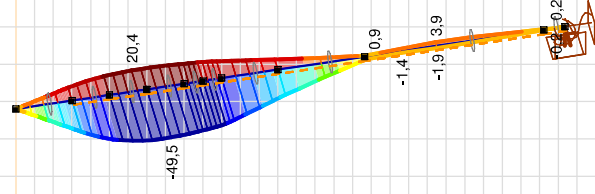

[III], > S 355, Non-lin., Omhullende (Standaard), Onmiddellijke doorbuiging, My, Lijnen (gevuld), Vooraanzicht

Project

Analysis by

Model: ZWO380 20210927 1-p rev1.axs

14-10-2021

Pag. 16

Niet-lineaire berekening	
Norm	Eurocode-NL
Geval	: Omhullende Min, Max
Omhullende	: Standaard
E (U)	: 1,85E-7
E (P)	: 7,46E-9
E (W)	: 7,53E-16
E (Eq)	: 4,24E-11
Comp.	: Mz [kNm]
Detail Max	: 16,7
Detail Min	: -169,6
Detail	: Alle materialen

Mz [kNm]	
16,7	
3,4	
-9,9	
-23,2	
-36,5	
-49,8	
-63,1	
-76,4	
-89,8	
-103,1	
-116,4	
-129,7	
-143,0	
-156,3	
-169,6	

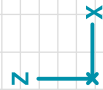
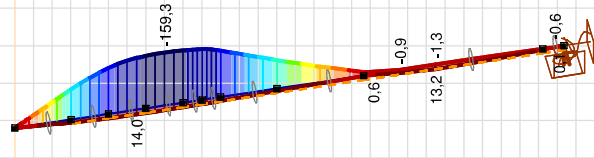
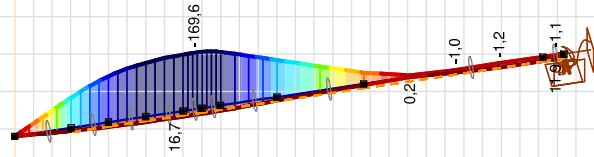

[III], > S 355; Non-lin., Omhullende (Standaard), Onmiddellijke doorbuiging, Mz, Lijnen (gevuld), Vooraanzicht

Project

Analysis by

Model: ZWO380 20210927 1-p rev1.axs

14-10-2021

Pag. 17

Niet-lineaire berekening	
Norm	Eurocode-NL
Geval	: Omhullende Min, Max
Omhullende	: Standaard
E (U)	: 1,85E-7
E (P)	: 7,46E-9
E (W)	: 7,53E-16
E (Eq)	: 4,24E-11
Comp.	: Nx [kN]
Detail Max	: 1460,2
Detail Min	: -1877,4
Detail	: Alle materialen

	Nx [kN]
	1460,2
	1221,8
	983,4
	745,0
	506,6
	268,2
	29,8
	-208,6
	-447,0
	-685,4
	-923,8
	-1162,2
	-1400,6
	-1639,0
	-1877,4

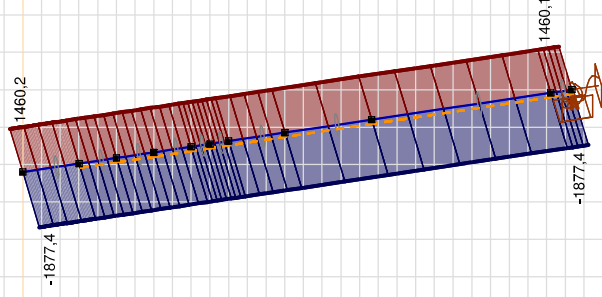
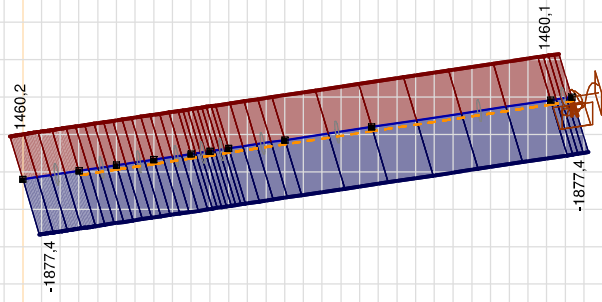

[III], > S 355; Non-lin., Omhullende (Standaard), Onmiddellijke doorbuiging, Nx, Lijnen (gevuld), Vooraanzicht

Project

Analysis by

Model: ZWO380 20210927 1-p rev1.axs

14-10-2021

Pag. 18

Niet-lineaire berekening	
Norm	Eurocode-NL
Geval	: Omhullende Min, Max
Omhullende	: Standaard
E (U)	: 1,85E-7
E (P)	: 7,46E-9
E (W)	: 7,53E-16
E (Eq)	: 4,24E-11
Comp.	: Vy [kN]
Detail Max	: 35,4
Detail Min	: -59,0
Detail	: Alle materialen

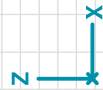
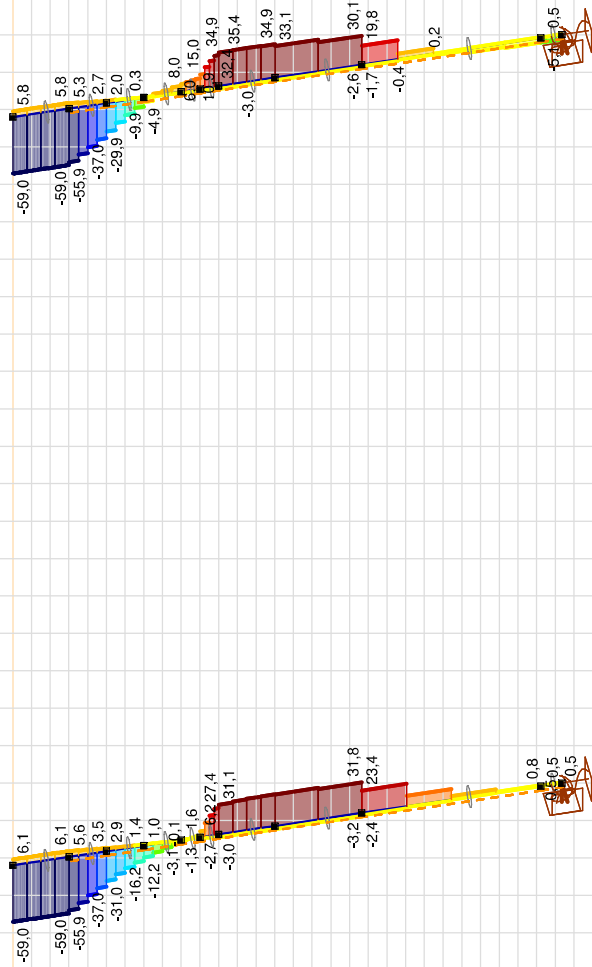
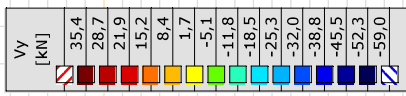

[III], > S 355; Non-lin., Omhullende (Standaard), Onmiddellijke doorbuiging, Vy, Lijnen (gevuld), Vooraanzicht

Project

Analysis by

Model: ZWO380 20210927 1-p rev1.axs

14-10-2021

Pag. 19

Niet-lineaire berekening	
Norm	Eurocode-NL
Geval	: Omhullende Min, Max
Omhullende	: Standaard
E (U)	: 1,85E-7
E (P)	: 7,46E-9
E (W)	: 7,53E-16
E (Eq)	: 4,24E-11
Comp.	: Vz [kN]
Detail Max	: 20,4
Detail Min	: -10,9
Detail	: Alle materialen

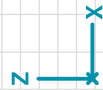
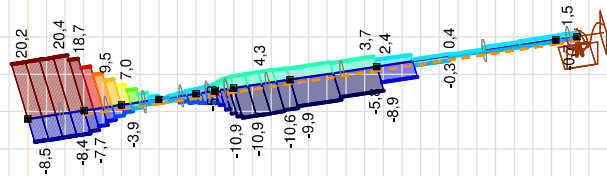
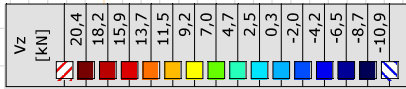
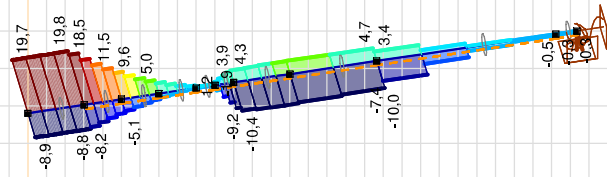

[III], > S 355; Non-lin., Omhullende (Standaard), Ommiddellijke doorbuiging, Vz, Lijnen (gevuld), Vooraanzicht

Project

Analysis by

Model: ZWO380 20210927 1-p rev1.axis

14-10-2021

Pag. 20

Staaftkrachten [Non-lin., Omhullende (UGT)]

Ext.	Prof.	Doorsnede naam	C	min. max.	Geval	Pos. [m]	Knoop	Nx [kN]	Vy [kN]	Vz [kN]	Tx [kNm]	My [kNm]	Mz [kNm]	B [kNm ²]
1	2	O 610x9	Nx	min	Co #2 [1] (1,000)	0	(3)	-1877,4	6,1	-8,8	0	13,6	9,4	0
2	2	O 610x9		min	Co #2 [1] (1,000)	0	(5)	-1877,4	3,5	-5,1	0	20,4	14,0	0
3	2	O 610x9		min	Co #2 [1] (1,000)	0	(4)	-1877,4	0,1	-0,1	0	24,3	16,7	0
4	2	O 610x9		min	Co #2 [1] (1,000)	0	(7)	-1877,4	-0,5	0,7	0	24,1	16,6	0
5	2	O 610x9		min	Co #2 [1] (1,000)	0	(2)	-1877,4	0,1	-0,2	0	-1,6	-1,1	0
6	2	O 610x9		min	Co #2 [1] (1,000)	1,187	(65)	-1877,4	-3,3	4,8	0	10,0	6,9	0
7	2	O 610x9		min	Co #2 [1] (1,000)	0	(6)	-1877,4	1,4	-2,1	0	23,5	16,2	0
8	2	O 610x9		min	Co #2 [1] (1,000)	0	(8)	-1877,4	-2,7	3,9	0	22,7	15,6	0
9	2	O 610x9		min	Co #2 [1] (1,000)	1,150	(29)	-1877,4	-3,0	4,3	0	21,1	14,5	0
10	2	O 610x9		min	Co #2 [1] (1,000)	0	(32)	-1877,4	0,5	-0,7	0	0,2	0,1	0
11	2	O 610x9		min	Co #2 [1] (1,000)	0	(33)	-1877,4	0,5	-0,7	0	-0,2	-0,1	0
12	2	O 610x9		min	Co #2 [1] (1,000)	0	(39)	-1877,4	0,3	-0,4	0	20,4	14,0	0
13	2	O 610x9		min	Co #2 [1] (1,000)	0	(44)	-1877,4	5,8	-8,4	0	13,0	8,9	0
14	2	O 610x9		min	Co #2 [1] (1,000)	0	(35)	-1877,4	2,7	-3,9	0	18,8	12,9	0
15	2	O 610x9		min	Co #2 [1] (1,000)	0	(48)	-1877,4	-1,0	1,5	0	19,5	13,4	0
16	2	O 610x9		min	Co #2 [1] (1,000)	0	(55)	-1877,4	-1,5	2,1	0	18,5	12,7	0
17	2	O 610x9		min	Co #2 [1] (1,000)	0	(59)	-1877,4	-2,8	4,0	0	16,8	11,6	0
18	2	O 610x9		min	Co #2 [1] (1,000)	1,150	(60)	-1877,4	-2,9	4,3	0	15,2	10,4	0
19	2	O 610x9		min	Co #2 [1] (1,000)	0	(10)	-1877,4	0,1	-0,1	0	-1,7	-1,2	0
20	2	O 610x9		min	Co #2 [1] (1,000)	1,187	(73)	-1877,4	-2,8	4,1	0	5,3	3,7	0
1	2	O 610x9		max	Co #1 [1] (1,000)	1,152	(14)	1460,2	-28,7	19,7	0	-7,6	-11,0	0
2	2	O 610x9		max	Co #1 [1] (1,000)	0,767	(17)	1460,2	-27,1	18,5	0	-35,1	-51,2	0
3	2	O 610x9		max	Co #1 [1] (1,000)	0,764	(22)	1460,1	-5,5	3,7	0	-53,9	-78,7	0
4	2	O 610x9		max	Co #1 [1] (1,000)	0,387	(23)	1460,1	-0,7	0,5	0	-55,3	-80,8	0
5	2	O 610x9		max	Co #1 [1] (1,000)	0	(2)	1460,1	0,4	-0,3	0	4,0	5,8	0
6	2	O 610x9		max	Co #1 [1] (1,000)	0	(63)	1460,1	14,6	-10,0	0	-11,5	-16,8	0
7	2	O 610x9		max	Co #1 [1] (1,000)	0,767	(11)	1460,1	-14,0	9,6	0	-48,0	-70,2	0
8	2	O 610x9		max	Co #1 [1] (1,000)	0,384	(26)	1460,1	2,7	-1,9	0	-55,0	-80,4	0
9	2	O 610x9		max	Co #1 [1] (1,000)	0	(9)	1460,0	15,8	-10,8	0	-36,0	-52,5	0
10	2	O 610x9		max	Co #1 [1] (1,000)	0	(32)	1460,1	-2,1	1,5	0	-0,2	-0,2	0
11	2	O 610x9		max	Co #1 [1] (1,000)	3,913	(72)	1460,1	8,4	-5,8	0	2,4	3,5	0
12	2	O 610x9		max	Co #1 [1] (1,000)	0,767	(36)	1460,1	-10,2	7,0	0	-47,2	-68,9	0
13	2	O 610x9		max	Co #1 [1] (1,000)	1,152	(41)	1460,2	-29,6	20,2	0	-7,8	-11,4	0
14	2	O 610x9		max	Co #1 [1] (1,000)	0,767	(45)	1460,2	-27,3	18,7	0	-36,0	-52,5	0
15	2	O 610x9		max	Co #1 [1] (1,000)	0,764	(51)	1460,1	0	0	0	-49,5	-72,3	0
16	2	O 610x9		max	Co #1 [1] (1,000)	0,387	(52)	1460,1	5,0	-3,4	0	-47,5	-69,3	0

Project

Analysis by

Model: **ZWO380 20210927 1-p rev1.axs**

14-10-2021

Pag. 21

Staaftkrachten [Non-lin., Omhullende (UGT)]

	Prof.	Doorsnede naam	C	min. max.	Geval	Pos. [m]	Knoop	Nx [kN]	Vy [kN]	Vz [kN]	Tx [kNm]	My [kNm]	Mz [kNm]	B [kNm ²]
17	2	O 610x9		max	Co #1 [1] (1,000)	0,384	(56)	1460,1	7,7	-5,3	0	-45,3	-66,1	0
18	2	O 610x9		max	Co #1 [1] (1,000)	0	(34)	1460,1	15,4	-10,6	0	-25,3	-36,9	0
19	2	O 610x9		max	Co #1 [1] (1,000)	3,668	(68)	1460,1	10,8	-7,4	0	-2,5	-3,7	0
20	2	O 610x9		max	Co #1 [1] (1,000)	0	(64)	1460,1	12,9	-8,9	0	-3,1	-4,5	0
1	2	O 610x9	Vy	min	Co #3 [1] (1,000)	1,152	(14)	-0,1	-59,0	-0,1	0	0	-22,6	0
13	2	O 610x9		min	Co #3 [1] (1,000)	1,152	(41)	-0,2	-59,0	-0,1	0	0	-22,6	0
18	2	O 610x9		max	Co #3 [1] (1,000)	0,767	(61)	-0,5	35,4	0,1	0	0,2	-112,6	0
18	2	O 610x9	Vz	min	Co #1 [1] (1,000)	0,767	(61)	1460,0	16,0	-10,9	0	-33,5	-48,9	0
13	2	O 610x9		max	Co #1 [1] (1,000)	0	(44)	1460,2	-29,8	20,4	0	-31,2	-45,6	0
14	2	O 610x9	Tx	min	Co #3 [1] (1,000)	0,767	(45)	-0,2	-55,9	-0,1	0	0,2	-104,9	0
20	2	O 610x9		max	Co #3 [1] (1,000)	1,187	(73)	-0,5	33,1	0,1	0	0,1	-46,3	0
4	2	O 610x9	My	min	Co #1 [1] (1,000)	0,258	(24)	1460,1	0,2	-0,1	0	-55,3	-80,8	0
3	2	O 610x9		max	Co #2 [1] (1,000)	0	(4)	-1877,4	0,1	-0,1	0	24,3	16,7	0
4	2	O 610x9		max	Co #2 [1] (1,000)	0,516	(4)	-1877,4	-0,1	0,2	0	24,3	16,7	0
4	2	O 610x9	Mz	min	Co #3 [1] (1,000)	0,258	(24)	-0,5	0,7	0	0	0,3	-169,6	0
3	2	O 610x9		max	Co #2 [1] (1,000)	0	(4)	-1877,4	0,1	-0,1	0	24,3	16,7	0
4	2	O 610x9		max	Co #2 [1] (1,000)	0,516	(4)	-1877,4	-0,1	0,2	0	24,3	16,7	0

Prof.: Profiel; **C:** Extreme component; **min. max.:** Extreme type; **Geval:** Belastinggeval van de extreme; **Pos.:** Lokale X-positie van de doorsnede op de staaf; **Nx:** Normalkracht; **Vy:** Dwarskracht in lokale y-richting; **Vz:** Dwarskracht in lokale z-richting; **Tx:** Torsiemoment; **My:** Buigend moment in lokale y-richting; **Mz:** Buigend moment in lokale z-richting.

Project

Analysis by

Model: ZWO380 20210927 1-p rev1.axs

14-10-2021

Pag. 22

Niet-lineaire berekening	
Norm	Eurocode-NL
Geval	: Omhullende Min, Max
Omhullende	: Standaard
E (U)	: 1,85E-7
E (P)	: 7,46E-9
E (W)	: 7,53E-16
E (Eq)	: 4,24E-11
Comp.	: eX [mm]
Detail Max	: 1,6
Detail Min	: -20,8
Detail	: Alle materialen

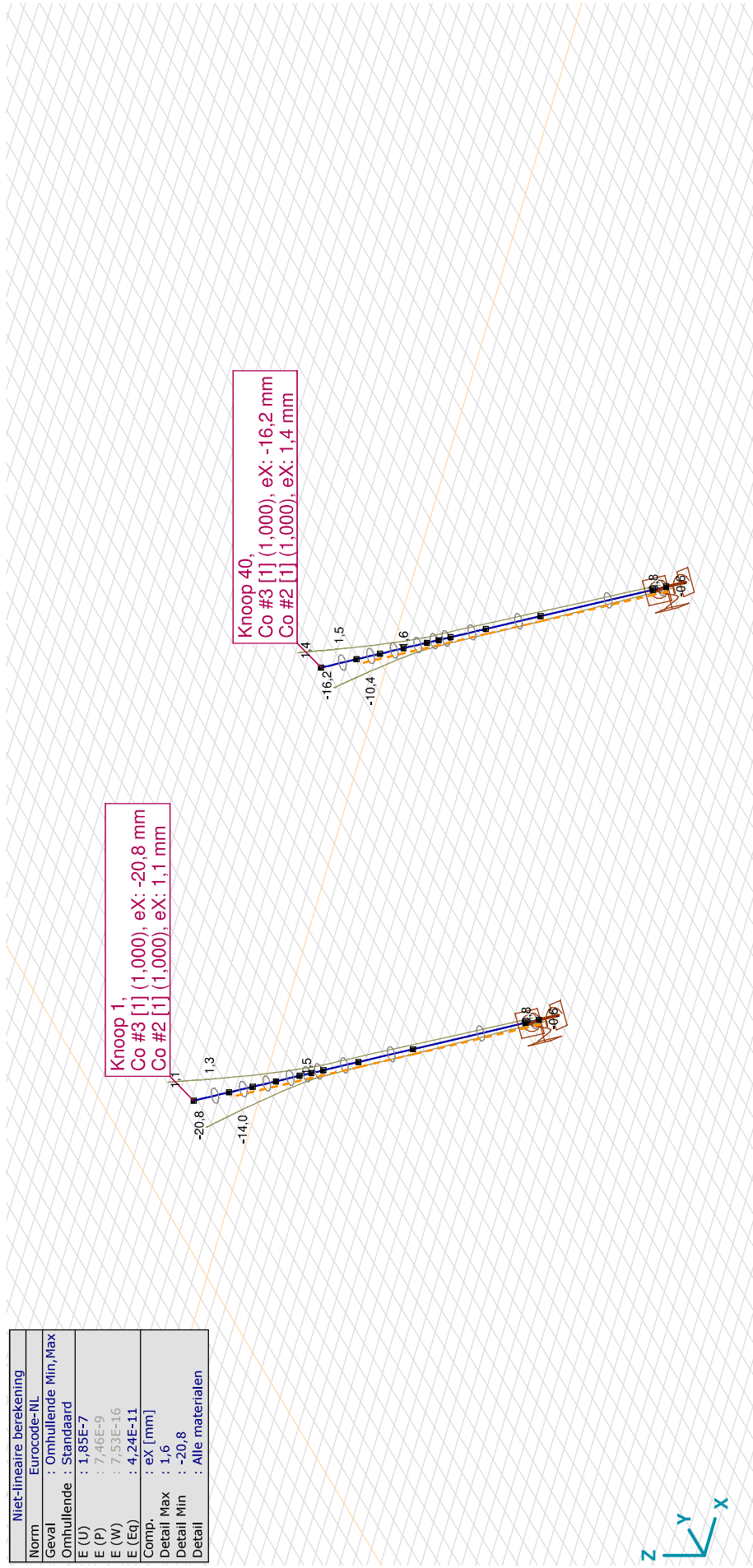

Knoop 1,
Co #3 [1] (1,000), eX: -20,8 mm
Co #2 [1] (1,000), eX: 1,1 mm

Knoop 40,
Co #3 [1] (1,000), eX: -16,2 mm
Co #2 [1] (1,000), eX: 1,4 mm

III, > S 355, Non-lin., Omhullende (Standaard), Onmiddellijke doorbuiging, eX, Lijnen

Project

Analysis by

Model: ZWO380 20210927 1-p rev1.axs

14-10-2021

Pag. 23

Niet-lineaire berekening	
Norm	Eurocode-NL
Geval	: Omhullende Min, Max
Omhullende	: Standaard
E (U)	: 1,85E-7
E (P)	: 7,46E-9
E (W)	: 7,53E-16
E (Eq)	: 4,24E-11
Comp.	: eY [mm]
Detail Max	: 20,8
Detail Min	: -2,8
Detail	: Alle materialen

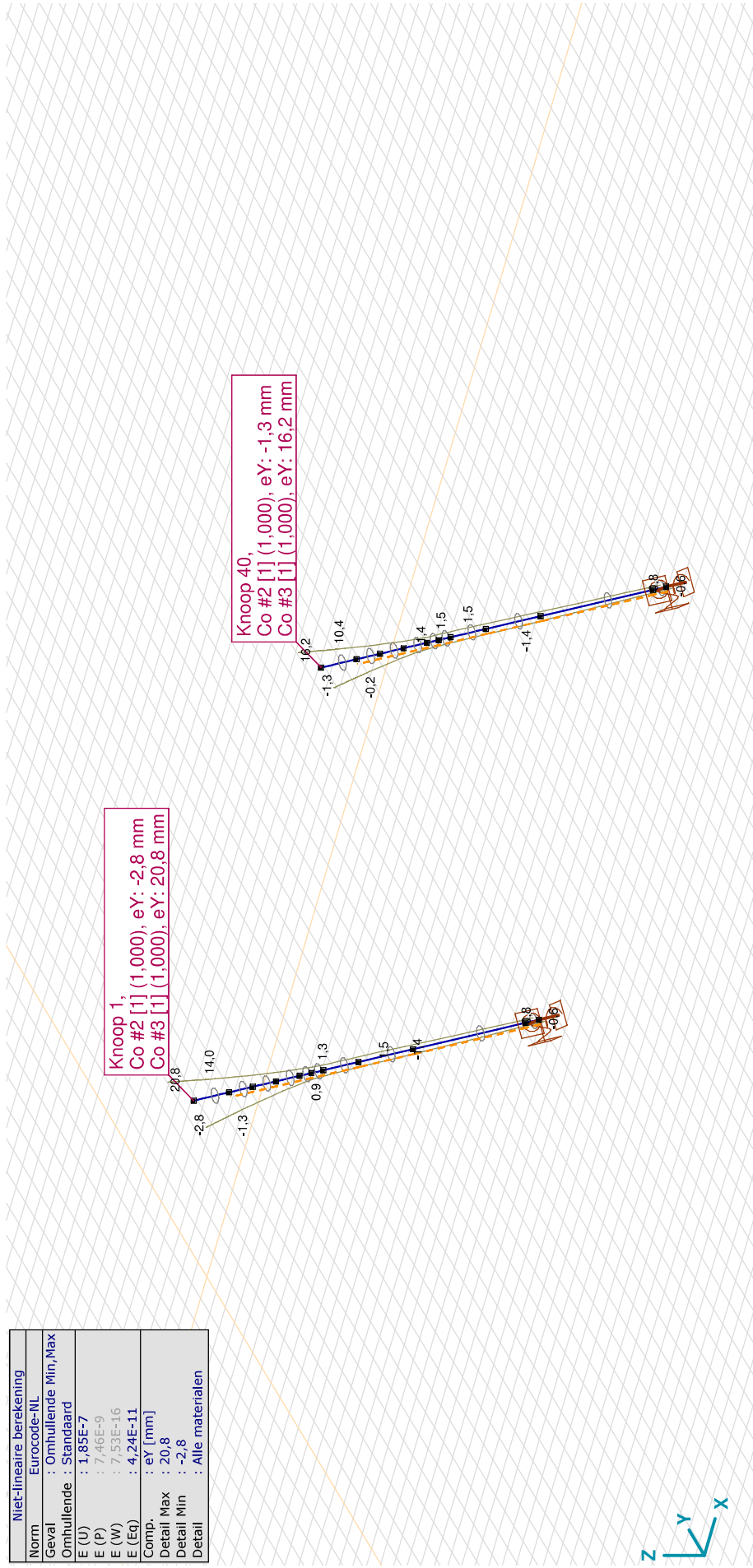

III. > S 355, Non-lin., Omhullende (Standaard), Onmiddellijke doorbuiging, eY, Lijnen

Project

Analysis by

Model: ZWO380 20210927 1-p rev1.axs

14-10-2021

Pag. 24

Niet-lineaire berekening	
Norm	Eurocode-NL
Geval	: Omhullende Min, Max
Omhullende	: Standaard
E (U)	: 1,85E-7
E (P)	: 7,46E-9
E (W)	: 7,53E-16
E (Eq)	: 4,24E-11
Comp.	: eZ [mm]
Detail Max	: 12,2
Detail Min	: -14,0
Detail	: Alle materialen

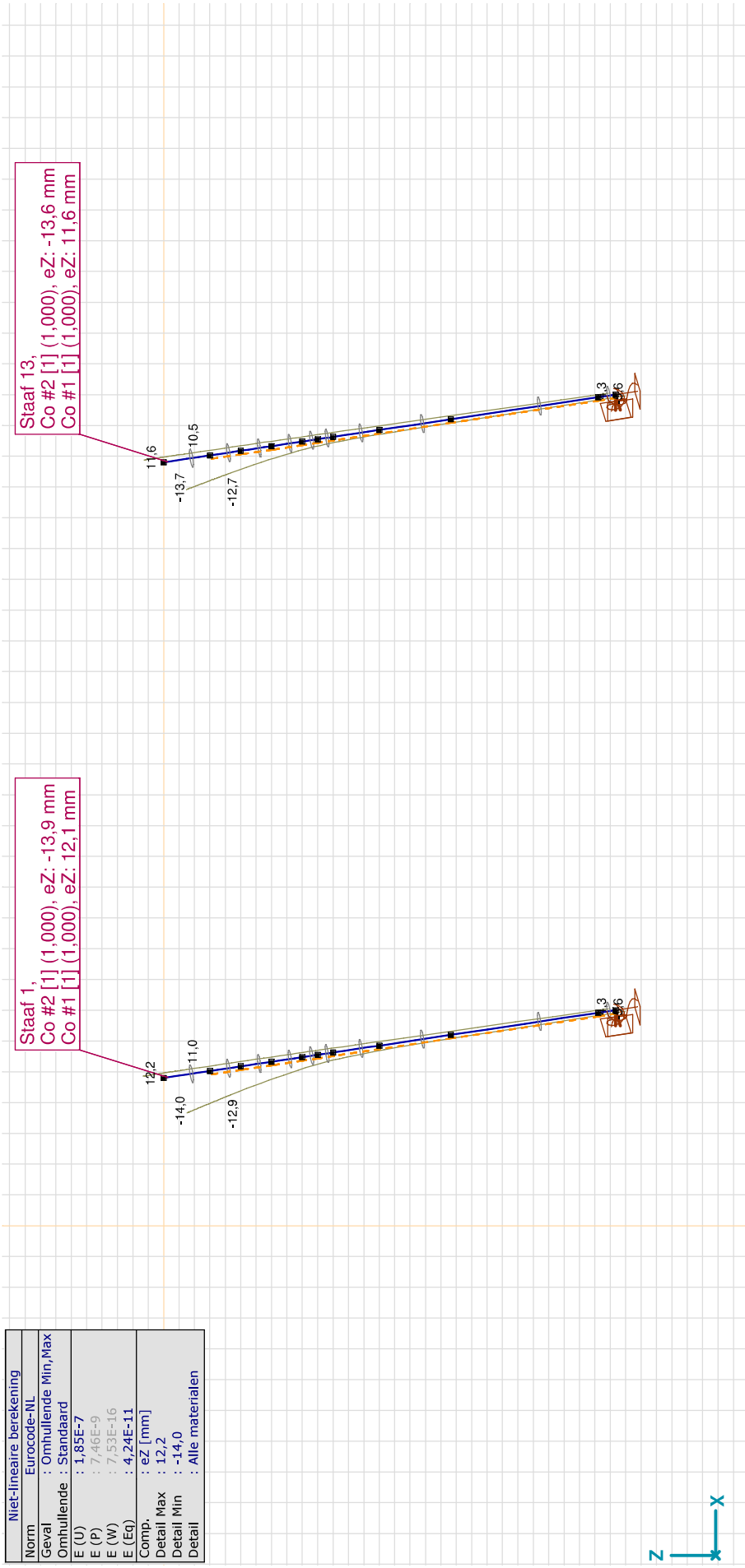

IIIJ. > S 355, Non-lin., Omhullende (Standaard), Onmiddellijke doorbuiging, eZ, Lijnen, Vooraanzicht

Project

Analysis by

Model: ZWO380 20210927 1-p rev1.axs

14-10-2021

Pag. 25

Niet-lineaire berekening	
Norm	Eurocode-NL
Geval	: Co #1 [1] (1,000)
E (U)	: 1,85E-7
E (P)	: 7,46E+9
E (W)	: 7,53E+16
E (Eq)	: 4,24E+11
Comp.	: eY [mm]
Detail Max	: 15,4
Detail Min	: -1,4
Detail	: Alle materialen

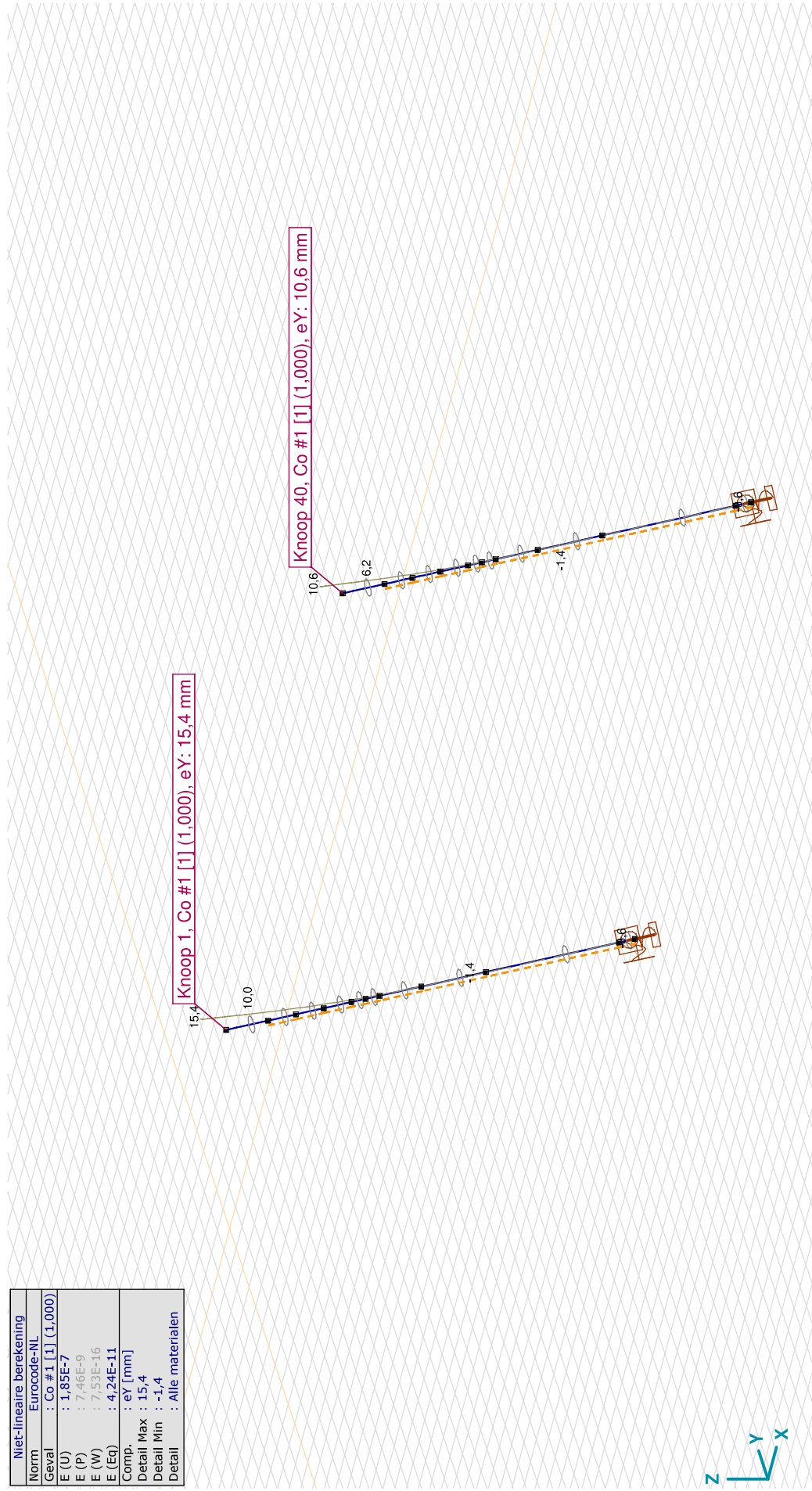

[1], > S 355, Non-lin., Co #1 [1] (1,000), Onmiddellijke doorbuiging, eY, Lijnen

Project

Analysis by

Model: ZWO380 20210927 1-p rev1.axs

14-10-2021

Pag. 26

Niet-lineaire berekening	
Norm	Eurocode-NL
Geval	: Co #3 [I] (1,000)
E (U)	: 3,65E+4
E (P)	: 5,03E+7
E (W)	: 2,71E+10
E (Eq)	: 8,44E+11
Comp.	: eY [mm]
Detail Max	: 20,8
Detail Min	: -0,6
Detail	: Alle materialen

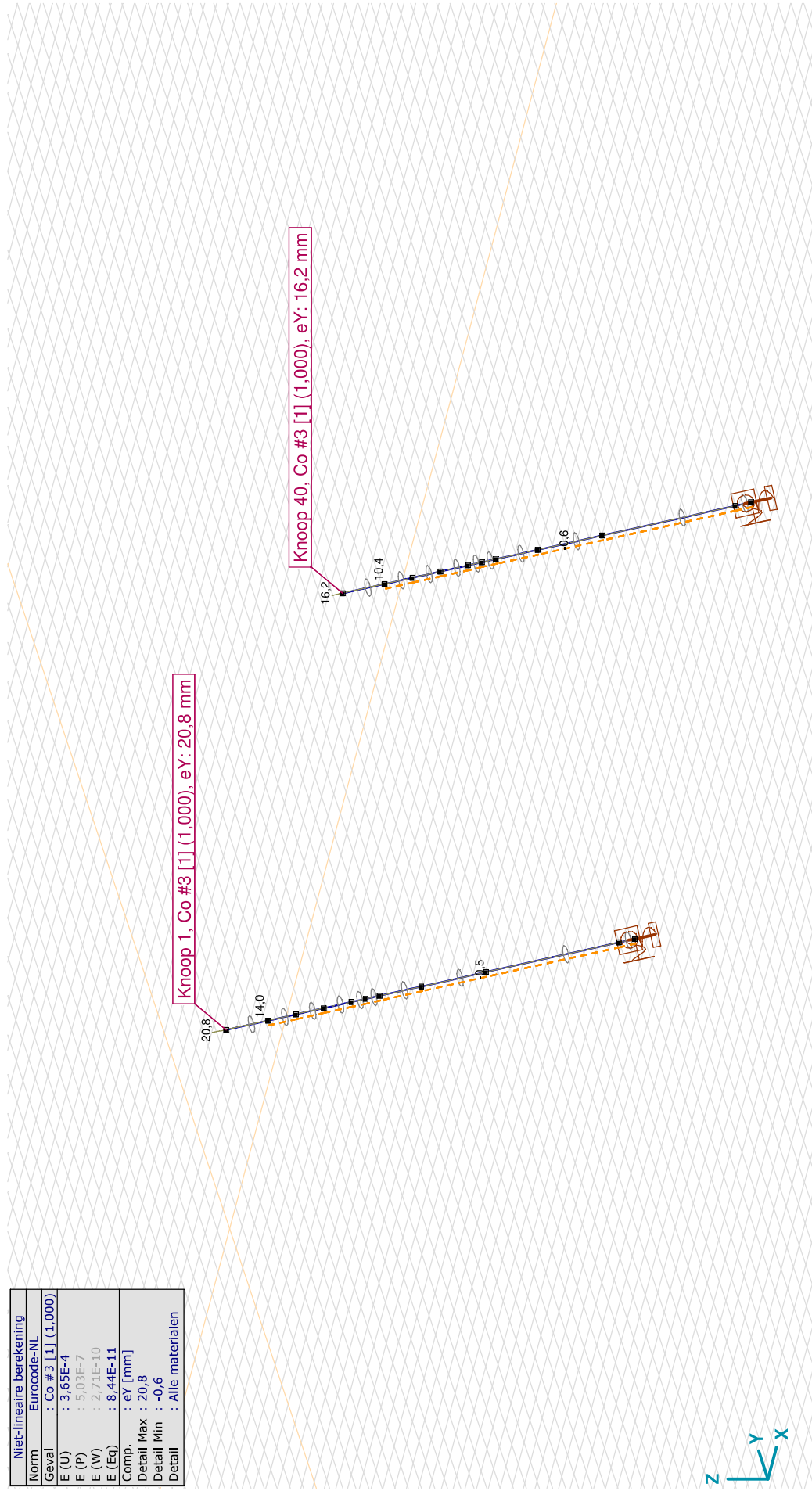

[I], > S 355, Non-lin., Co #3 [I] (1,000), Onmiddellijke doorbuiging, eY, Lijnen

Project

Analysis by

Model: **ZWO380 20210927 1-p rev1.axs**

14-10-2021

Pag. 27

Knoopverplaatsingen [Non-lin., Omhullende (UGT), S 355]

C	min. max.	Geval	eX [mm]	eY [mm]	eZ [mm]	eR [mm]	fX [rad]	fY [rad]	fZ [rad]	fR [rad]
Ext.										
1	eX	Co #3 [1] (1,000)	-20,8	20,8	-0,1	29,4	-0,0044	-0,0044	-0,0013	0,0064
39	max	Co #2 [1] (1,000)	1,6	0,9	-11,4	11,6	0,0005	-0,0001	0,0001	0,0005
49	max	Co #2 [1] (1,000)	1,6	1,2	-11,0	11,2	0,0004	-0,0001	0	0,0004
50	max	Co #2 [1] (1,000)	1,6	1,1	-11,2	11,3	0,0004	-0,0001	0	0,0004
51	max	Co #2 [1] (1,000)	1,6	1,0	-11,3	11,5	0,0004	-0,0001	0,0001	0,0005
1	eY	Co #2 [1] (1,000)	1,1	-2,8	-14,0	14,3	0,0011	-0,0002	0,0001	0,0011
1	max	Co #3 [1] (1,000)	-20,8	20,8	-0,1	29,4	-0,0044	-0,0044	-0,0013	0,0064
1	eZ	Co #2 [1] (1,000)	1,1	-2,8	-14,0	14,3	0,0011	-0,0002	0,0001	0,0011
1	max	Co #1 [1] (1,000)	-4,9	15,4	12,2	20,2	-0,0036	-0,0006	-0,0006	0,0037
54	eR	Co #3 [1] (1,000)	-1,4	1,4	0	2,0	-0,0014	-0,0014	-0,0004	0,0021
1	max	Co #3 [1] (1,000)	-20,8	20,8	-0,1	29,4	-0,0044	-0,0044	-0,0013	0,0064

C: Extreme component; **min.**, **max.:** Extreme type; **Geval:** Belastinggeval van de extreme; **eX:** Verplaatsing in X-richting; **eY:** Verplaatsing in Y-richting; **eZ:** Verplaatsing in Z-richting; **eR:** Resulterende verplaatsing; **fX:** Rotatie in X-richting; **fY:** Rotatie in Y-richting; **fZ:** Rotatie in Z-richting; **fR:** Resulterende rotatie;

Project

Analysis by

Model: ZWO380 20210927 1-p rev1.axs

14-10-2021

Pag. 28

Niet-lineaire berekening	
Norm	Eurocode-NL
Geval	: Omhullende Min, Max
Omhullende	: Standaard
E (U)	: 1,85E-7
E (P)	: 7,46E-9
E (W)	: 7,53E-16
E (Eq)	: 4,24E-11
Comp.	: Rx [kN]
Detail Max	: 1460,1
Detail Min	: -1877,4
Detail	: Alle materialen

Rx [kN]	
1460,1	
1221,7	
983,3	
744,9	
506,5	
268,1	
29,7	
-208,6	
-447,0	
-685,4	
-923,8	
-1162,2	
-1400,6	
-1639,0	
-1877,4	

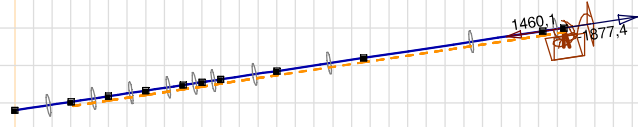
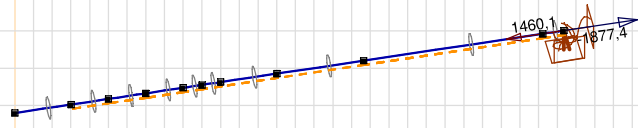

[I], > S 355, Non-lin., Omhullende (Standaard), Onmiddellijke doorbuiging, Rx (knoopopl.), Lijnen, Vooraanzicht

Project

Analysis by

Model: ZWO380 20210927 1-p rev1.axs

14-10-2021

Pag. 29

Niet-lineaire berekening	
Norm	Eurocode-NL
Geval	: Omhullende Min, Max
Omhullende	: Standaard
E (U)	: 1,85E-7
E (P)	: 7,46E-9
E (W)	: 7,53E-16
E (Eq)	: 4,24E-11
Comp.	: Ry [kN/m]
Detail Max	: 14,0
Detail Min	: -61,1
Detail	: Alle materialen

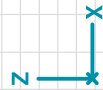
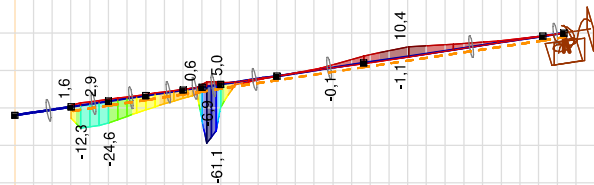
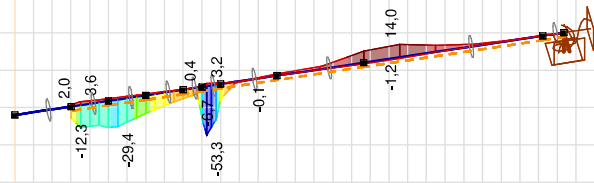
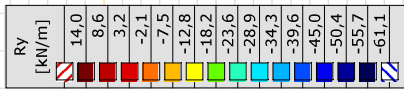

III, > S 355, Non-It., Omhullende (Standaard), Onmiddellijke doorbuiging, Ry (lijnopp.), Lijnen (gevuld), Vooraanzicht

Project

Analysis by

Model: ZWO380 20210927 1-p rev1.axs

14-10-2021

Pag. 30

Niet-lineaire berekening	
Norm	Eurocode-NL
Geval	: Omhullende Min, Max
Omhullende	: Standaard
E (U)	: 1,85E-7
E (P)	: 7,46E-9
E (W)	: 7,53E-16
E (Eq)	: 4,24E-11
Comp.	: Rz [kN/m]
Detail Max	: 21,5
Detail Min	: -7,3
Detail	: Alle materialen

Rz	[kN/m]
21,5	
19,5	
17,4	
15,3	
13,3	
11,2	
9,2	
7,1	
5,0	
3,0	
0,9	
-1,1	
-3,2	
-5,3	
-7,3	

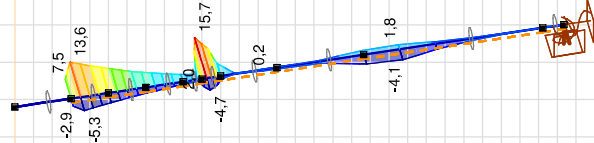
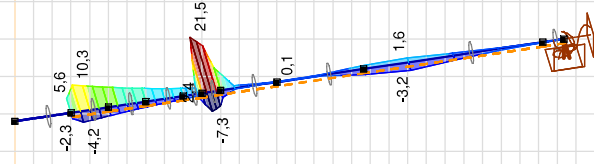

III, > S 355, Non-It., Omhullende (Standaard), Onmiddellijke doorbuiging, Rz (lijnopp.), Lijnen (gevuld), Vooraanzicht

Project

Analysis by

Model: **ZWO380 20210927 1-p rev1.axs**

14-10-2021

Pag. 31

Interne krachten knooppoplegging [Non-lin., Omhullende (Standaard), S 355]

Ext.	Knoop	X [m]	Y [m]	Z [m]	Type	C	min. max.	Geval	Rx [kN]	Ry [kN]	Rz [kN]	Rr [kN]	Rxx [kNm]	Ryy [kNm]	Rzz [kNm]	Rrr [kNm]	αR
	1	27,001	7,001	-14,673	Staaft r.	Rx	min	Co #2 [1] (1,000)	-1877,4	0,5	-0,7	1877,4	0	0,2	0,1	0,3	-2570,203
	2	7,001	7,001	-14,673	Staaft r.		min	Co #2 [1] (1,000)	-1877,4	0,1	-0,2	1877,4	0	-1,6	-1,1	1,9	-9818,083
	1	27,001	7,001	-14,673	Staaft r.		max	Co #1 [1] (1,000)	1460,1	-2,1	1,5	1460,1	0	-0,2	-0,2	0,3	996,293
	2	7,001	7,001	-14,673	Staaft r.		max	Co #1 [1] (1,000)	1460,1	0,5	-0,3	1460,1	0	4,0	5,8	7,0	-4712,829

Knoop: Ondersteunde knoop; **Type:** Opleggingsstype; **C:** Extreme component; **min. max.:** Belastinggeval van de extreme; **Rx:** X-component opleggingsreactiekracht; **Ry:** Y-component opleggingsreactiekracht; **Rz:** Z-component opleggingsreactiekracht;

Rr: Resulterende opleggingsreactiekracht; **Rxx:** X-component opleggingsreactiemoment; **Ryy:** Y-component opleggingsreactiemoment; **Rzz:** Z-component opleggingsreactiemoment; **Rrr:** Resultierend opleggingsreactiemoment;

αR : Verhouding verticale oplegkracht / horizontale oplegkracht;

Project

Analysis by

Model: ZWO380 20210927 1-p rev1.axs

14-10-2021

Pag. 32

Niet-lineaire berekening	
Norm	Eurocode-NL
Geval	: Omhullende Min, Max
Omhullende	: Standaard
E (U)	: 1,85E-7
E (P)	: 7,46E-9
E (W)	: 7,53E-16
E (Eq)	: 4,24E-11
Comp.	: Sominmax [N/mm ²]
Detail Max	: 120,5
Detail Min	: 0
Detail	: Alle materialen

Sominmax [N/mm ²]	
120,5	
111,9	
103,3	
94,7	
86,1	
77,5	
68,9	
60,3	
51,7	
43,0	
34,4	
25,8	
17,2	
8,6	
0	

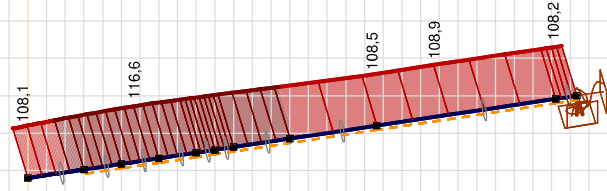
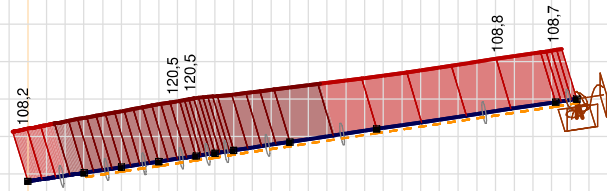

[II] > S 355, Non-lin., Omhullende (Standaard), Onmiddellijke doorbuiging, Sominmax, Lijnen (gevuld), Voorraanzicht

Project

Analysis by

Model: **ZWO380 20210927 1-p rev1.axs**

14-10-2021

Pag. 33

Staafspanningen [Non-lin., Omhullende (Standaard), S 355]

Ext.	Prof.	Doorsnede naam	C	min. max.	Geval	Pos. [m]	Knoop	S _x :min [N/mm ²]	S _x :max [N/mm ²]	V _{min} [N/mm ²]	V _{max} [N/mm ²]	S _o :min [N/mm ²]	S _o :max [N/mm ²]	V _y :gem [N/mm ²]	V _z :gem [N/mm ²]
3	2	O 610x9	S _x :min	min	Co #2 [1] (1,000)	0	(4)	-117,6	-98,7	0	0	98,7	117,6	0	0
4	2	O 610x9		min	Co #2 [1] (1,000)	0,516	(4)	-117,6	-98,7	0	0	98,7	117,6	0	0
8	2	O 610x9		min	Co #2 [1] (1,000)	0,512	(7)	-117,5	-98,8	0	0,1	98,8	117,5	0	0,1
1	2	O 610x9		max	Co #1 [1] (1,000)	1,535	(1)	84,1	84,1	0	3,3	84,1	84,3	-1,7	1,1
10	2	O 610x9		max	Co #1 [1] (1,000)	0,144	(77)	84,1	84,1	0	0,2	84,1	84,1	-0,1	0,1
13	2	O 610x9		max	Co #1 [1] (1,000)	1,535	(40)	84,1	84,1	0	3,4	84,1	84,3	-1,7	1,2
1	2	O 610x9	S _x :max	min	Co #2 [1] (1,000)	1,535	(1)	-108,1	-108,1	0	1,0	108,1	108,2	0,4	-0,5
10	2	O 610x9		min	Co #2 [1] (1,000)	0,287	(78)	-108,1	-108,1	0	0,1	108,1	108,1	0	0
11	2	O 610x9		min	Co #2 [1] (1,000)	0	(33)	-108,2	-108,1	0	0,1	108,1	108,2	0	0
13	2	O 610x9		min	Co #2 [1] (1,000)	1,535	(40)	-108,1	-108,1	0	1,0	108,1	108,1	0,3	-0,5
3	2	O 610x9		max	Co #4 [1] (1,000)	0	(4)	44,6	120,5	0	0,2	44,6	120,5	-0,1	0
4	2	O 610x9		max	Co #4 [1] (1,000)	0,258	(24)	44,5	120,5	0	0	44,5	120,5	0	0
8	2	O 610x9		max	Co #4 [1] (1,000)	0,512	(7)	44,6	120,5	0	0,4	44,6	120,5	0,2	0
10	2	O 610x9	S _o :min	min	Co #3 [1] (1,000)	0,144	(77)	-0,1	0	0	0,6	0	1,0	-0,3	0
1	2	O 610x9		max	Co #2 [1] (1,000)	1,535	(1)	-108,1	-108,1	0	1,0	108,1	108,2	0,4	-0,5
10	2	O 610x9		max	Co #2 [1] (1,000)	0,287	(78)	-108,1	-108,1	0	0,1	108,1	108,1	0	0
11	2	O 610x9		max	Co #2 [1] (1,000)	0	(33)	-108,2	-108,1	0	0,1	108,1	108,2	0	0
13	2	O 610x9		max	Co #2 [1] (1,000)	1,535	(40)	-108,1	-108,1	0	1,0	108,1	108,1	0,3	-0,5
19	2	O 610x9		max	Co #2 [1] (1,000)	3,668	(68)	-108,2	-108,0	0	0,4	108,0	108,2	-0,1	0,2
11	2	O 610x9	S _o :max	min	Co #3 [1] (1,000)	0	(33)	-0,9	0,9	0	0,6	0	1,0	-0,3	0
3	2	O 610x9		max	Co #4 [1] (1,000)	0	(4)	44,6	120,5	0	0,2	44,6	120,5	-0,1	0
4	2	O 610x9		max	Co #4 [1] (1,000)	0,258	(24)	44,5	120,5	0	0	44,5	120,5	0	0
8	2	O 610x9		max	Co #4 [1] (1,000)	0,512	(7)	44,6	120,5	0	0,4	44,6	120,5	0,2	0

Prof.: Profiel; **C:** Extreem type; **min. max.:** Extreem type; **Geval:** Belastinggeval van de extreme; **Pos.:** Lokale X-positie van de doorsnede op de staaf; **S_x:min:** Doorsnede minimum normaalspanning; **S_x:max:** Doorsnede maximum normaalspanning;

V_{min}: Doorsnede minimum afschuifspanning; **V_{max}:** Doorsnede maximum afschuifspanning; **S_o:min:** Doorsnede minimum Von Mises spanning; **S_o:max:** Doorsnede maximum Von Mises spanning; **V_y:gem:** Afschuifspanning in lokale Y-richting;

V_z:gem: Afschuifspanning in lokale Z-richting;



About DNV

DNV is the independent expert in risk management and assurance, operating in more than 100 countries. Through its broad experience and deep expertise DNV advances safety and sustainable performance, sets industry benchmarks, and inspires and invents solutions.

Whether assessing a new ship design, optimizing the performance of a wind farm, analyzing sensor data from a gas pipeline or certifying a food company's supply chain, DNV enables its customers and their stakeholders to make critical decisions with confidence.

Driven by its purpose, to safeguard life, property, and the environment, DNV helps tackle the challenges and global transformations facing its customers and the world today and is a trusted voice for many of the world's most successful and forward-thinking companies.

B.6 Mastrapportage eindmast



ZUID-WEST 380 KV OOST VERBINDINGEN

Mastrapport combi-eindmast EA-3/co

TenneT TSO B.V.

Meridian doc.nr.: 002.678.00.0928560

Rapport nr.: 21-0823, Rev. 1

Datum: 26-07-2021





Projectnaam: Zuid-West 380 kV Oost Verbindingen Energy Systems
Rapport titel: Mastrapport combi-eindmast EA-3/co DNV Netherlands B.V.
Klant: TenneT TSO B.V., Utrechtseweg 310, 6812 AR Arnhem Utrechtseweg 310-B50
Contactpersoon klant: ██████████ 6812 AR Arnhem
Datum uitgave: 26-07-2021
Project nr.: 10124719
Organisatie unit: Transmission & Distribution Technology (TDT) Tel: 026 356 9111
Meridian doc.nr.: 002.678.00.0928560 Handelsregister Arnhem 09006404
Rapport nr.: 21-0823, Rev. 1

Geschreven door:  Beoordeeld door:  Goedgekeurd door:

Copyright © DNV 2021. All rights reserved. Unless otherwise agreed in writing: (i) This publication or parts thereof may not be copied, reproduced or transmitted in any form, or by any means, whether digitally or otherwise; (ii) The content of this publication shall be kept confidential by the customer; (iii) No third party may rely on its contents; and (iv) DNV undertakes no duty of care toward any third party. Reference to part of this publication which may lead to misinterpretation is prohibited.

DNV Distributie:

- Open
- Intern
- Commercieel vertrouwelijk
- Vertrouwelijk
- Geheim

*Specificatie distributie: --

Trefwoorden:

[Trefwoorden]

Rev.	Datum	Reden van uitgave	Auteur	Beoordelaar	Goedkeuder
0	02-07-2021	Eerste uitgave			
1	26-07-2021	RFA-commentaar verwerkt			

Inhoudsopgave

1	INLEIDING	1
2	UITGANGSPUNTEN EN RANDVOORWAARDEN	2
2.1	Normen	2
2.2	TenneT-specificaties	2
2.3	Eisenverificatie	2
2.4	Ontwerprapporten	2
2.5	Materialen	2
2.6	Software	3
3	MASTONTWERP	4
3.1	Mastbeelden	4
3.2	Aflopers	4
3.3	Veerconstructie aflopers	5
3.4	Mastbeeld	6
3.5	Uitgangspunten berekening	6
3.6	Mastenlijst	7
3.7	Geleiderbelastingen	7
3.8	Reacties op de fundering	7
3.9	Modellering	7
3.10	Overige controles	8
3.11	Mastgewicht	8
4	TOETSING	9
4.1	Resultaat PLS-TOWER	9
4.2	Toetsing overige onderdelen	10
Appendix A	Geleiderbelastingen	
Appendix B	Resultaten PLS	
Appendix C	Knikverkorters	
Appendix D	Blokdeuvels	
Appendix E	Liggers	
Appendix F	Sterkte-coördinatie	
Appendix G	Galloping	

1 INLEIDING

In het basisontwerp van de vakwerkmasten voor de verbinding RLL-TLB380 in het project Zuid-West 380 kV-Oost zijn voor het vaststellen van de haalbaarheid constructieve berekeningen uitgevoerd aan de masten en fundaties. In de Definitief Ontwerpfase, moeten berekeningen verder worden uitgewerkt om te kunnen dienen voor de benodigde vergunningsdocumentatie, voor de aanbesteding en als voorbereiding voor de uitvoeringsfase. Het DO omvat het ontwerp van de mastconstructies, de fundaties en de opstijpunten in de verbinding.

Deze rapportage bevat de resultaten van de toetsing van de combi-eindmast EA-3/co, een masttype geschikt voor twee circuits 380 kV en twee circuits 150kV. De toetsing bestaat uit controle van:

- de profielen en boutverbindingen onderdeel van de hoofd draagconstructie
- de knikverkorters
- de liggers voor de isolator kettingen
- de verbinding met de fundatie via blokdeuvels
- galloping

Sterkte-coördinatie is niet meegenomen in het ontwerp van de combi-eindmast als bij de andere masttypes. De eindmast is ontworpen om de volledige trekkracht¹ te weerstaan van het lijn veld. Het toepassen van extra sterkte in het mastlichaam ten opzichte van de traverse zou resulteren in een oneconomische constructie (met verder verzwaarde randstijlen). Er is extra sterkte in de mast aanwezig door het toepassen van de "bouw fase" load case, wat erop neer komt dat de ULS-belastingen² aan één zijde van de mast aanwezig zijn, in plaats van de SPLS-belastingen.

Buiten de scope van dit DO-rapport valt de controle van de schetsplaten en overige verbinding details in de constructie. Dit moet in de UO-fase worden uitgewerkt. Ook de voorzieningen voor de high-step rail en bordessen vallen onder uitwerking in UO-fase.

In hoofdstuk 2 zijn de uitgangspunten en randvoorwaarden vanuit de van toepassing zijnde normen en TenneT-specificaties opgenomen. Hoofdstuk 3 beschrijft de gevolgde aanpak van de berekening. In hoofdstuk 4 is de toetsing opgenomen.

¹ Zie uitgangspuntendocument 002.678.00 0876917.

² ULS 15 jaar is hier bij deze eenzijdige belasting het uitgangspunt in plaats van 50 jaar met alle circuits aanwezig.

2 UITGANGSPUNTEN EN RANDVOORWAARDEN

2.1 Normen

Er is gebruik gemaakt van de normen volgens Tabel 1.

Tabel 1 Gebruikgemaakte normen, voorschriften en richtlijnen

Norm	Titel
NEN-EN 50341-1:2013	“Overhead electrical lines exceeding AC 1 kV - Part 1: General requirements – Common”
NEN-EN 50341-2-15:2019	“Overhead electrical lines exceeding AC 1 kV Part 2 National Normative Aspects (NNA) for THE NETHERLANDS”
NEN-EN 1990+A1+A1/C2:2019/NB:2019nl	“Grondslagen van het ontwerp”
NEN-EN 1991-1-4+A1+C2:2011/NB:2019+C1:2020	“Deel 1-4: Windbelasting op constructies”
NEN-EN 1992-1-1+C2:2011/NB:2016+A1:2020	“Eurocode 2: Ontwerp en berekening van betonconstructies, deel 1-1: algemene regels en regels voor gebouwen”
NEN-EN 1993-1-1+C2+A1:2016 nl	“Eurocode 3: Ontwerp en berekening van staalconstructies, deel 1-1: algemene regels en regels voor gebouwen”
NEN-EN 1993-3-1:2007/NB:2011 nl	“Deel 3-1: Torens, masten en schoorstenen - Torens en masten”
NEN-EN 1993-1-8+C2:2011/NB:2011 nl	“Ontwerp en berekening van staalconstructies, deel 1-8: ontwerp en berekening van verbindingen”

2.2 TenneT-specificaties

In Tabel 2 zijn de documenten opgenomen die relevant zijn voor de berekeningen en toetsingen die binnen dit project in de mastrapportage uitgevoerd zullen worden.

Tabel 2 Relevante documenten t.b.v. mechanische rapportages

Nummer	Onderwerp
PVE.05.000 v3.2	PvE Lijnen
sPVE.05.001	sPvE Lijnen
SPE.05.346 v1.3	Algemene specificatie stalen masten

2.3 Eisenverificatie

Voor de eisenverificatie wordt verwezen naar het rapport “Verificatierapport eisen DO Moldau”, DNV GL rapport 21-0451, Meridiannummer 002.678.00 0910757.

2.4 Ontwerppapporten

Voor de achtergrond van het ontwerp wordt verwezen naar het uitgangspuntenrapport “Uitgangspunten definitief ontwerp Moldaumast”, DNV GL rapport 21-0036, Meridiannummer 002.678.00 0876917.

2.5 Materialen

Voor het ontwerp van de mastconstructies en fundaties wordt uitgegaan van de eigenschappen volgens Tabel 3.

Tabel 3 Materialen aangepaste constructie

Staalsoort	S355J0 (t≤16 mm) S355J2 (16<t≤40 mm)
Boutkwaliteit	8.8 gerolde draad
Betonkwaliteit	C30/37
Wapeningsstaal	B500



Voor de constructie geldt conform TenneT-specificatie:

- Toe te passen bouten: M16/M20/M24;
- Voor hoekstaal is de minimale afmeting L50x5 mm;
- Minimale plaatdikte 6 mm.

Mocht het noodzakelijk zijn M30 toe te passen, bij grote plaatdiktes is dit als afwijking door TenneT toegestaan.

2.6 Software

De gebruikte software wordt benoemd in Tabel 4.

Tabel 4 Toegepaste software

Software		Versie
Mastontwerp	PLS-CADD	16.65
Mastberekeningen	PLS-TOWER	16.65
Constructieve analyse	AxisVM	X5 R4h

3 MASTONTWERP

3.1 Mastbeelden

In dit hoofdstuk worden de mastbeelden weergegeven met de belangrijkste maatvoering, voor volledige tekeningen van de masttypen wordt verwezen naar onderstaande tekeningen:

- Mastbeeldtekening Bijzondere masten, Meridiannummer 002.678.00 0890101
- Overzichtstekening EA-3/co, Meridiannummer 002.678.00 0927495
- Principedetails combi-eindmasten, Meridiannummer 002.678.00 0927499

3.2 Aflopers

Masttype EA-3/co (co: combi-opstijgpunt) is een combi-eindmast voor twee circuits 380 kV en twee circuits 150kV. De 380 kV-geleiders en bliksemraden gaan bij deze mast in steile diagonale richting naar een grondopstelling voor de overgang naar de kabelverbinding in het tracé. De 150 kV-geleiders gaan in verticale richting naar de grondopstelling. Dit is identiek aan masttype HA+0/ci.

Om de verticale afloop te faciliteren zijn alle traversen voorzien van uitkragende liggers om voldoende spanningsafstand te creëren, hierbij gaat de afloper van de boventraverse achter de midden- en ondertraverse langs. De geleider van de middentraverse van het lijnveld wordt afgespannen op de uitkragende liggers en de afloper gaat voor de traversen langs. Alleen aan de boventraverse zijn post-isolatoren voor de bretelle opgehangen. Aan de midden- en ondertraverse zijn extra horizontale post-isolatoren opgehangen. De 380 kV-geleider op de ondertraverse is naar buiten verplaatst.

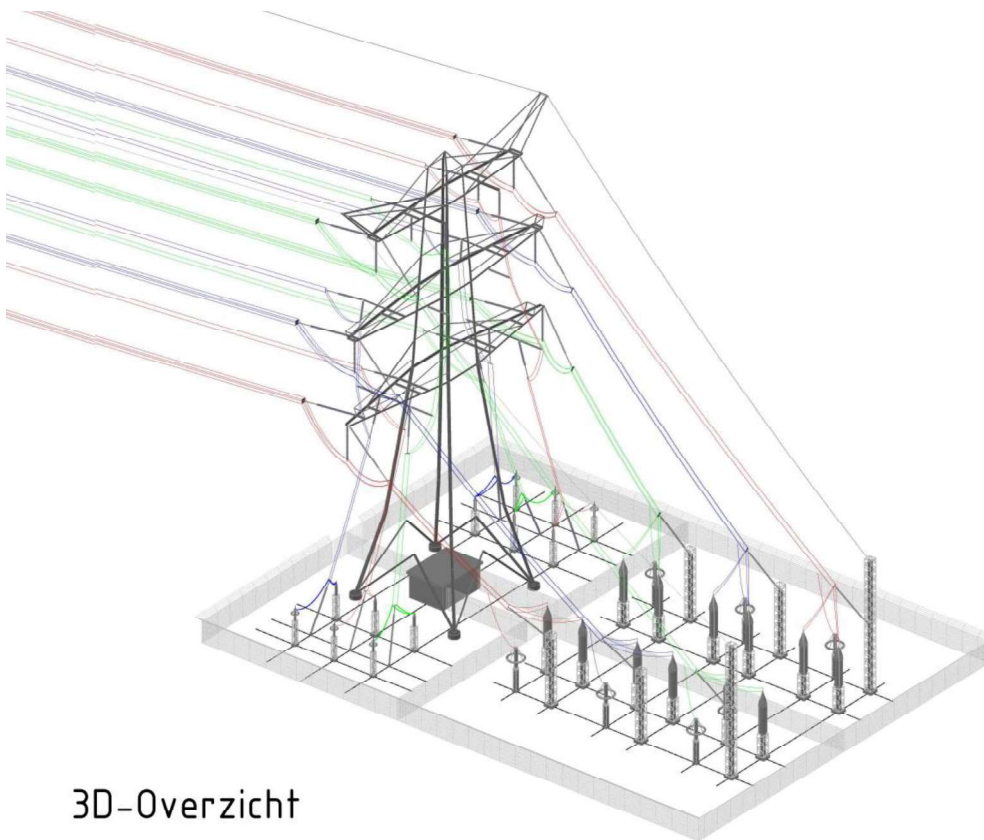

Figuur 1 Principeontwerp EA-3/co-eindmast

3.3 Veerconstructie aflopers

3.3.1 Veerconstante 150 kV geleider

De verticale geleiders dienen met een veerconstructie te worden afgespannen naar de grond. Deze veer is benodigd vanwege verschillen in temperatuursuitzetting van geleider en mast en om vervormingen van de mastconstructie op te vangen. Het uitgangspunt voor de veerconstructie is:

- maximaal 50 mm veerweg na het aanbrengen van de voorspankracht. De maximale verplaatsing is een belangrijke eis om te grote verplaatsingen van de geleider onder windbelasting te voorkomen.
- voorspanning 5 kN
- veerstijfheid in de orde van 100 kN/m (zie hieronder)
- belasting in uiterste grenstoestand 25 kN

In de berekening is een hogere fictieve veerstijfheid gehanteerd van 1000 kN/m. Dit is een conservatief uitgangspunt waarbij een verplaatsing van 50 mm wordt gevonden (zie Appendix A). In werkelijkheid zal de stijfheid van de veer lager zijn, echter als de verplaatsing 50 mm bedraagt, zal de veer niet meer kunnen vervormen en zal de geleiderstijfheid de trekkracht bepalen. Om niet te gunstige waarden voor de trekkracht te vinden is er gerekend met een fictieve stijfheid waarbij de verplaatsing maximaal 50 mm is. De waarde voor de werkelijke veerstijfheid moet zodanig zijn dat onder reguliere windbelastingen geen klapperen van de veer optreedt. Bij de waarde van 100 kN/m is er bij 50 mm verplaatsing een krachtstoename van 5 kN mogelijk, een verdubbeling ten opzichte van de voorspankracht.

3.3.2 Veerconstante 380 kV-geleiders

De 380 kV-geleiders hebben een grotere vervormingsmogelijkheid voor temperatuursverschillen en andere vervormingen. Deze worden zonder een veerconstructiebevestigd. De vakwerkkolommen met bijbehorende fundatie van de grondopstelling hebben echter een bepaalde veerstijfheid, die in rekening is gebracht. In de berekening is daarvoor de waarde van 10000 kN/m gehanteerd, dit is een veilige waarde ten opzichte van de werkelijke stijfheid.

3.4 Mastbeeld

In Figuur 2 is het schematische mastbeeld opgenomen.

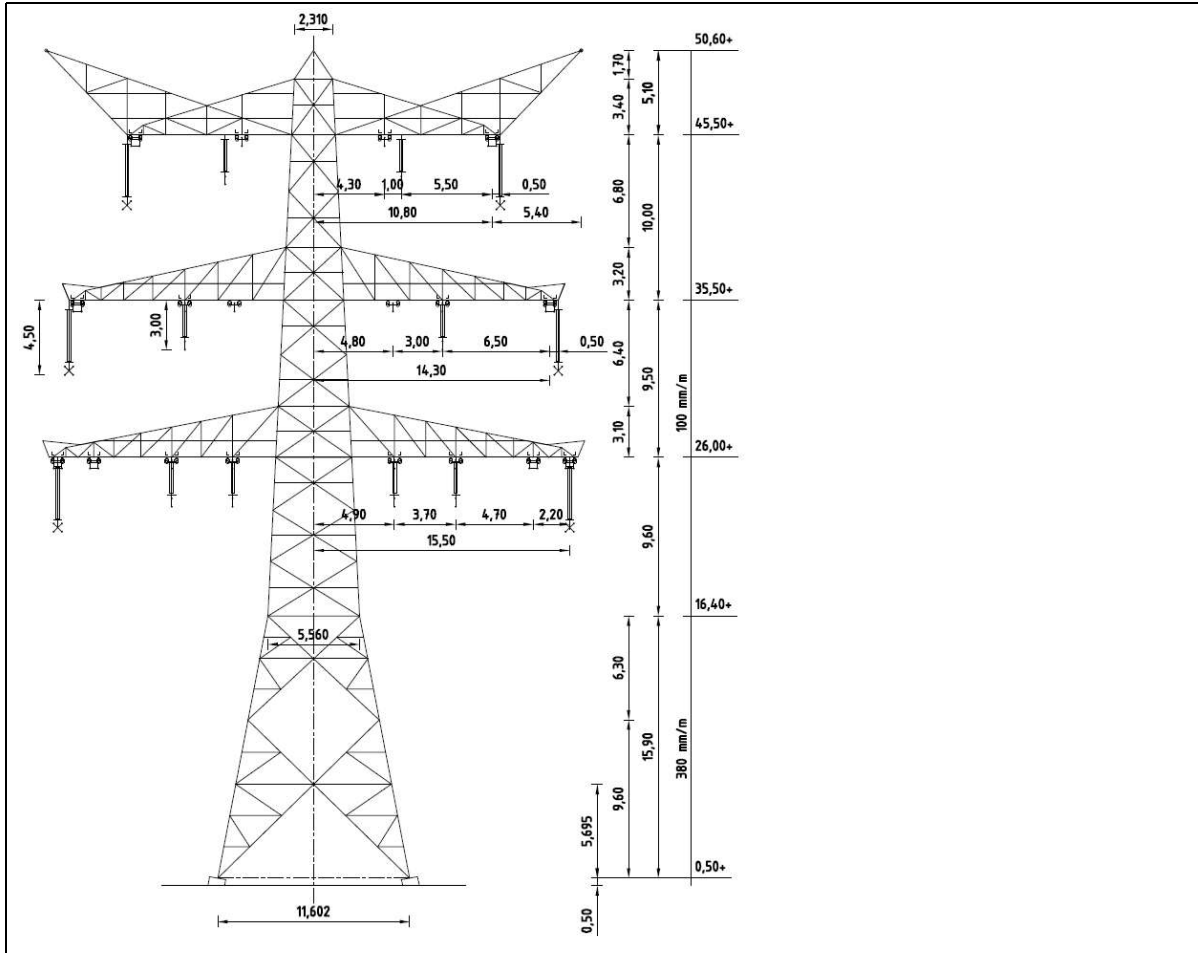

Figuur 2 Mastbeeld masttype EA-3/co

3.5 Uitgangspunten berekening

De uitgangspunten volgens Tabel 5 zijn van toepassing.

Tabel 5 Uitgangspunten

Norm	NEN-EN50341-2-15:2019
Gevolgklasse initieel	CC2
Betrouwbaarheidsniveau	Nieuwbouw
Referentieperiode	50 jaar
Windgebied	III
Windsnelheid (m/s)	24,5
Terreincategorie	II
Reductiefactor c_{dir}	1,00
IJsgebied fasegeleider	B
IJsgebied bliksemgeleider	A

3.6 Mastenlijst

De mastenlijst is gebaseerd op de “staking table” van het DO-uitgangspuntenrapport en benaamd als “VKA 1.1 Concept 20201112 1037-1044_1086-1094_1099-1105_1192-1204.xlsx”. De mastenlijst is vanwege lopende traceringsvraagstukken aan verandering onderhevig en is derhalve indicatief.

In Tabel 6 zijn alle masten in het tracé van het type EA-3/co opgenomen. De mast met grootste wind span is vetgedrukt aangegeven. Het masttype zal niet met deze wind en weight span worden berekend maar met generieke wind en weight span, zie uitgangspuntenrapport.

Tabel 6 Mastenlijst EA-3/co

Mast-nummer	Masttype	Lijnhoek (°)	Wind span (m)	Weight span (m)	Hoogteverschil ba+ah (m)	Hoogteverschil back (m)	Hoogteverschil ahead (m)
1025	EA-3 co	180.0	152.1	153.5	7.6	7.4	0.2

3.7 Geleiderbelastingen

De berekening is uitgevoerd met het geleiderbelastingprogramma van DNV GL. De belastingen op de mastconstructie zijn bepaald op basis van de modellering in PLS-TOWER (staafoppervlaktes). Voor de toeslagen op eigen gewicht en windoppervlakte wordt verwezen naar het uitgangspuntenrapport. In Appendix A zijn de resultaten van de geleiderbelastingen samengevat.

De geleiderkrachten van de verticale geleiders zijn berekend met een spreadsheet voor aflopers. Hierin is de invloed van de veerstijfheid meegenomen van de bevestiging.

De kortsluitkrachten tussen de aflopers zijn separaat berekend, zie Appendix A. Deze zijn in de geleiderbelastingen opgenomen als extra load cases.

3.8 Reacties op de fundering

De oplegreacties op de fundering worden ontleend aan de uitvoer van PLS TOWER. Dit is in afwijking op andere masttypes uit de reeks, vanwege de verticale geleiders. Zie Appendix A.

3.9 Modelling

Op basis van de ontwerptekeningen is de mast in PLS-TOWER ingevoerd. De toetsing wordt per staafgroep uitgevoerd. De hoofdelementen zijn gemodelleerd, niet-dragende profielen als knikverkorters zijn weggelaten, deze worden separaat getoetst. De profielen zijn in PLS-TOWER inclusief de boutverbindingen ingevoerd en getoetst, de controle van de schetsplaten en andere detailverbindingen valt buiten de scope.

De geleiderbelastingen vanuit het geleiderbelastingenprogramma zijn als invoer voor de belastingen gebruikt.

De gewichts- en windbelasting op de mastconstructie wordt door PLS-TOWER automatisch bepaald. Via toeslagfactoren wordt de invloed van niet gemodelleerde elementen als knikverkorters, bordesconstructies en klimvoorzieningen meegenomen. Voor schetsplaten, zinklaag en bouten is een aanvullende toeslag op het gewicht van 20% toeslag gerekend.

Diagonalen in voor- en achtervlak respectievelijk de twee zijvlakken zijn samengenomen in een groep.

3.10 Overige controles

In PLS-TOWER zijn niet alle elementen getoetst. Knikverkorterprofielen en overige profielen voor beloopbaarheid worden separaat getoetst. In Appendix C is dit opgenomen. De verbinding met de fundatie bestaat uit ingestorte profielen voorzien van blokdeuvels. Dit is in Appendix D opgenomen. De liggers van isolatorkettingen vereisen een aanvullende controle op buiging. De toetsing is uitgevoerd met de software AxisVM en is beschreven in Appendix E. Voor hoekmasten moet een toetsing op vermoeiing worden uitgevoerd voor galloping. Dit is in Appendix G opgenomen.

De mastranden uitgevoerd als XEA-profielen worden separaat op torsieknik gecontroleerd. Dit is in Appendix B opgenomen. De berekende capaciteit die lager is dan de capaciteit voor buigingsknik is in PLS-TOWER via aangepaste buckling-ratio ingevoerd.

3.11 Mastgewicht

Het totale mastgewicht per masttype is met de uitgangspunten van paragraaf 3.9 bepaald op:

- Masttype EA-3/co 104,5 ton

Ten opzichte van masttypes HA/c, HC/c en HA+0/ci zijn de volgende meest belangrijke verschillen en overeenkomsten aanwezig:

- Afmetingen van de boventraverse zijn gelijk aan de HA/c mast behalve dat de EA-3/co uitkragende liggers heeft voor de 150kV geleiders. De boventraverse van de EA-3/co mast heeft andere belastingen dan de HA/c mast en daardoor zijn diverse profielen verzwaard. De onderrand profielen zijn gelijk gebleven;
- Afmetingen van de middentraverse zijn gelijk aan de HA/c mast behalve dat de EA-3/co uitkragende liggers heeft voor de 150kV geleiders en dat een 150kV geleider dichterbij het mastlichaam geplaatst is. De middentraverse van de EA-3/co mast heeft andere belastingen dan de HA/c mast en daardoor zijn diverse profielen verzwaard. De onderrand profielen zijn gelijk gebleven;
- De ondertraverse heeft geen overeenkomsten met de andere masttypen;
- De randstijlen van het mastlichaam zijn hetzelfde uitgevoerd als mast HC+0/c behalve het tussenstuk; bij mast EA-3/co is de randstijl van het tussenstuk één geheel tot de ondertraverse en uitgevoerd in XEA250x24, in plaats van twee verschillende XEA profielen;
- Diagonalen en horizontalen in mastlichaam zijn verzwaard;
- De profielen van de uitkragende liggers voor de 150kV geleiders zijn gelijk aan mast HA+0/ci.

4 TOETSING

4.1 Resultaat PLS-TOWER

Het resultaat van de toetsing met PLS-TOWER is weergegeven in Figuur 3. De belastingen zijn bepaald voor het masttype EA-3/co, inclusief bouwphase en afspannen.

De uitnuttig van de constructie loopt op van blauw (0-25%) tot geel (75-100%). Uit de figuur wordt geconcludeerd dat alle profielen en boutverbindingen voldoen.

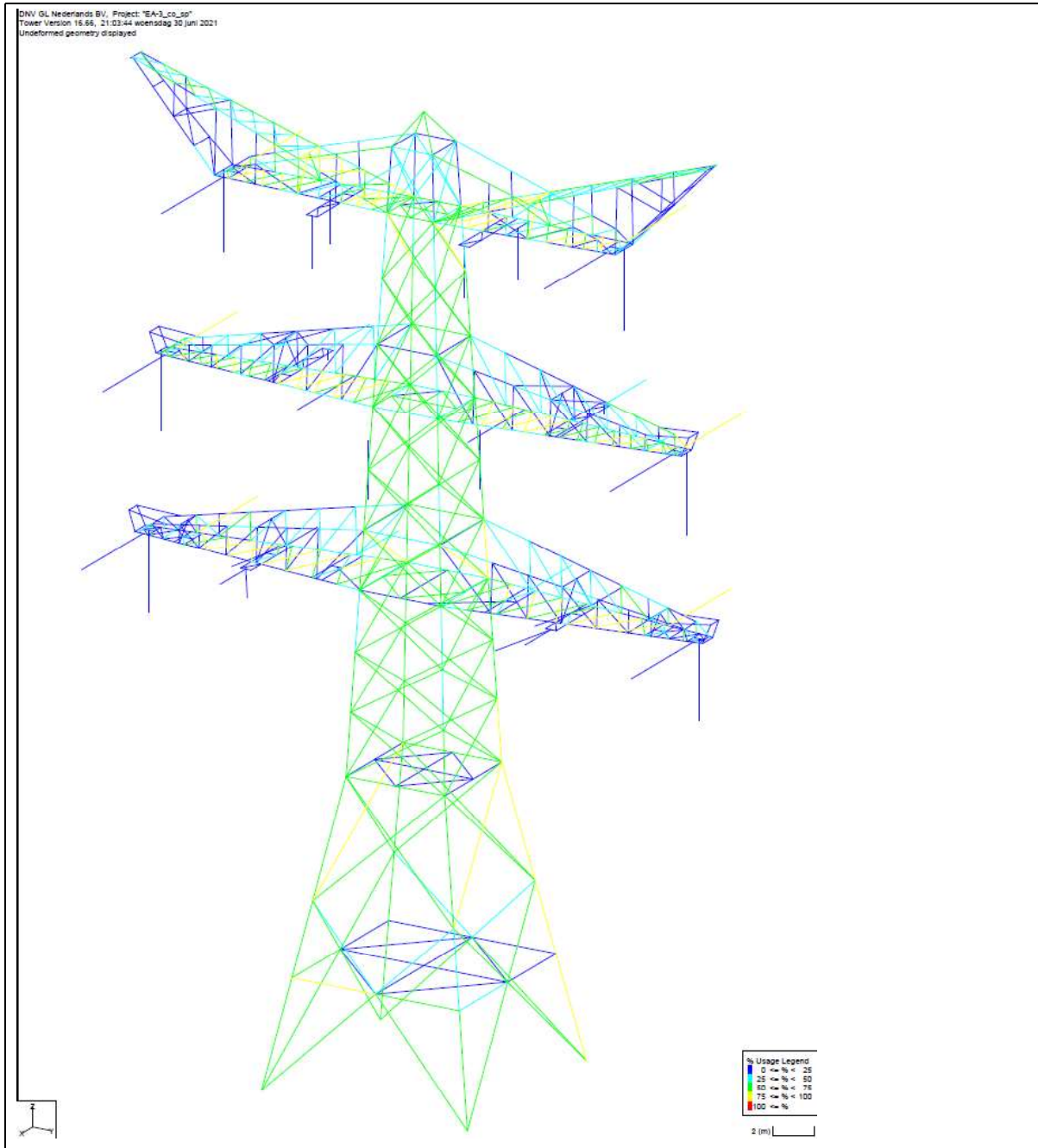

Figuur 3 Resultaat PLS-TOWER voor masttype EA-3/so

4.2 Toetsing overige onderdelen

In Tabel 7 zijn de resultaten van de uitgevoerde toetsingen weergegeven.

Tabel 7 Samenvatting uitgevoerde controles

Controle van	Beoordeling	Referentie
Profielen	Voldoen	Figuur 3 Appendix B
Knikverkorters	Voldoen	Appendix C
Blokdeuvels randstijl	Voldoen	Appendix D
Liggers	Voldoen	Appendix E
Sterkte-coördinatie	N.v.t.	-
Galloping	Voldoet	Appendix G

APPENDIX A

Geleiderbelastingen

Geleiderbelastingen opgenomen:

- Masttype EA-3/co geleiderbelastingen
- Masttype EA-3/co verticale geleiders
- Masttype EA-3/co bouwfase
- Kortsluitbelastingen
- Reacties fundering PLS-TOWER

Belastingen door afspannen zijn gelijk aan masttype HA+0 en niet opgenomen in dit rapport.

Project: RLL-TLB380
 Tower: EA-3_co
 Number: 1025

Auteur: TBR
 Versie: v12.0

Geleiderbelastingen

Algemeen

Benaming EA-3_co
 Masttype Eindmast ahead afwezig
 Aantal circuits 4
 Configuratie 4-circuit-dubbel verticaal
 Aantal bliksemgeleiders 2

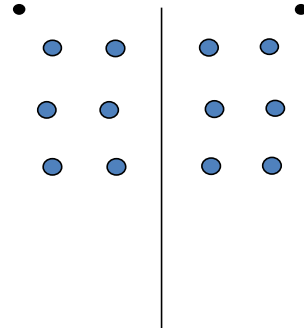

Configuratie geleiders

Uitgangspunten

Norm NEN-EN50341-2-15:2019
 Gevolgklasse initieel CC2
 Betrouwbaarheidsniveau initieel Nieuwbouw
 Referentieperiode initieel 50 jaar
 CC2
 Betrouwbaarheidsniveau na aanpassing n.v.t.
 50 jaar
 Windgebied III
 Windsnelheid (m/s) 24,5 m/s
 Terreincategorie II
 Reductiefactor C_{dir} 1,00
 IJsg gebied fasegeleider B
 IJsg gebied bliksemgeleider A

Geleiders Back

Omschrijving	Spanning	Geleider Back	Bundel Ba	IJsg gebied	Toeslag gewicht	Toeslag diameter	Intrekwaarden P_{back}
Circuit 1	380 kV	AAAC-AL7 620	4	B	3 %	3 %	1800
Circuit 2	380 kV	AAAC-AL7 620	4	B	3 %	3 %	1800
Circuit 3	150 kV	AAAC-AL7 620	2	B	3 %	3 %	1800
Circuit 4	150 kV	AAAC-AL7 620	2	B	3 %	3 %	1800
Bliksemdraad 1		AACSR 241-AL3-39-A20SA	1	A	2 %	2 %	1800
Bliksemdraad 2		OPGW AFL-226/38	1	A	2 %	2 %	1800

Geleiders Ahead

Omschrijving	Spanning	Geleider Ahead	Bundel Ah	IJsg gebied	Toeslag gewicht	Toeslag diameter	Intrekwaarden P_{ahead}
Circuit 1	380 kV	AAAC-AL7 620	4	B	3 %	3 %	1800
Circuit 2	380 kV	AAAC-AL7 620	4	B	3 %	3 %	1800
Circuit 3	150 kV	AAAC-AL7 620	2	B	3 %	3 %	1800
Circuit 4	150 kV	AAAC-AL7 620	2	B	3 %	3 %	1800
Bliksemdraad 1		AACSR 241-AL3-39-A20SA	1	A	2 %	2 %	1800
Bliksemdraad 2		OPGW AFL-226/38	1	A	2 %	2 %	1800

Isolatoren (1)

Omschrijving	Ophanging	Gewicht [kN]	Lengte [m]	Windopp. [m ²]
Circuit 1	Afspanketting	3,00	6,50	1,10
Circuit 2	Afspanketting	3,00	6,50	1,10
Circuit 3	Afspanketting	2,00	3,50	0,80
Circuit 4	Afspanketting	2,00	3,50	0,80
Bliksemdraad 1	Afspanketting	0,10	0,20	0,10
Bliksemdraad 2	Afspanketting	0,10	0,20	0,10

1. Eigenschappen gelden voor geheel van de isolatorset

Ophanghoogte en positie in mast

Circuits	Aanduiding	Nummer	Ophanghoogte	Aangrijppunt	Positie in mast Horizontale afstand
Circuit 1	10	380ct1f1	45,0 m	45,0 m	-10,8 m
Circuit 1	11	380ct1f2	35,0 m	35,0 m	-14,3 m
Circuit 1	12	380ct1f3	25,5 m	25,5 m	-13,3 m
Circuit 2	40	380ct2f1	45,0 m	45,0 m	10,8 m
Circuit 2	41	380ct2f2	35,0 m	35,0 m	14,3 m
Circuit 2	42	380ct2f3	25,5 m	25,5 m	13,3 m
Circuit 3	20	150ct3f1	45,0 m	45,0 m	-4,3 m
Circuit 3	21	150ct3f2	35,0 m	35,0 m	-7,8 m
Circuit 3	22	150ct3f3	25,5 m	25,5 m	-4,9 m
Circuit 4	30	150ct4f1	45,0 m	45,0 m	4,3 m
Circuit 4	31	150ct4f2	35,0 m	35,0 m	7,8 m
Circuit 4	32	150ct4f3	25,5 m	25,5 m	4,9 m
Bliksemdraad 1	1	bl1	50,1 m	50,1 m	-16,2 m
Bliksemdraad 2	3	bl2	50,1 m	50,1 m	16,2 m

Project: RLL-TLB380
 Tower: EA-3_co
 Number: 1025

Hoogteaanpassing naastgelegen masten (aanpassing wind- en weight span)

	Back	Ahead	
Verhoging voor windbelasting	18,0 m	6,0 m	(positief: omhoog)
Verlaging voor verticale belasting	-9,0 m	-9,0 m	(negatief: omlaag, grotere weight span)
Verlaging: Niet in 0,9EG-combinaties			

Hoogteafwijking mastbeeld naastgelegen masten en richtingsverandering t.o.v. Lijnrichting

Circuits	Aanduiding	Nummer	Hoogteverschil		Richtingsverandering	
			Δh back	Δh ahead	Δy back	Δy ahead
Circuit 1	10	380ct1f1	0,0	0,0 m	0,0	0,0 m
Circuit 1	11	380ct1f2	0,0	0,0 m	0,0	0,0 m
Circuit 1	12	380ct1f3	0,0	0,0 m	0,0	0,0 m
Circuit 2	40	380ct2f1	0,0	0,0 m	0,0	0,0 m
Circuit 2	41	380ct2f2	0,0	0,0 m	0,0	0,0 m
Circuit 2	42	380ct2f3	0,0	0,0 m	0,0	0,0 m
Circuit 3	20	150ct3f1	0,0	0,0 m	0,0	0,0 m
Circuit 3	21	150ct3f2	0,0	0,0 m	0,0	0,0 m
Circuit 3	22	150ct3f3	0,0	0,0 m	0,0	0,0 m
Circuit 4	30	150ct4f1	0,0	0,0 m	0,0	0,0 m
Circuit 4	31	150ct4f2	0,0	0,0 m	0,0	0,0 m
Circuit 4	32	150ct4f3	0,0	0,0 m	0,0	0,0 m
Bliksemdraad 1	1	bl1	0,0	0,0 m	0,0	0,0 m
Bliksemdraad 2	3	bl2	0,0	0,0 m	0,0	0,0 m

Lijn- en mastgegevens

	Back	Ahead
Ruling span $\sqrt{(\Sigma L^3)/\Sigma L}$	400,0	400,0 m
Lijnhoek β	180 °	
Rotatie mast t.o.v. bissectrice θ	0 °	
Vaklengte	400	400 m
Hoogte onderkant mast t.o.v. maaiveld	0,5 m	
Beschouwde windrichtingen	α_1	0 °
Windrichtingen volgens: Geleiderbelastingen	α_2	45 °
	α_3	90 °
	α_4	135 °
	α_5	75 °
	α_6	105 °

Windrichtingen gelden t.o.v. hoofdrichting mastconstructie, niet t.o.v. bissectrice.

Windrichtingen en positieve richtingen belastingen

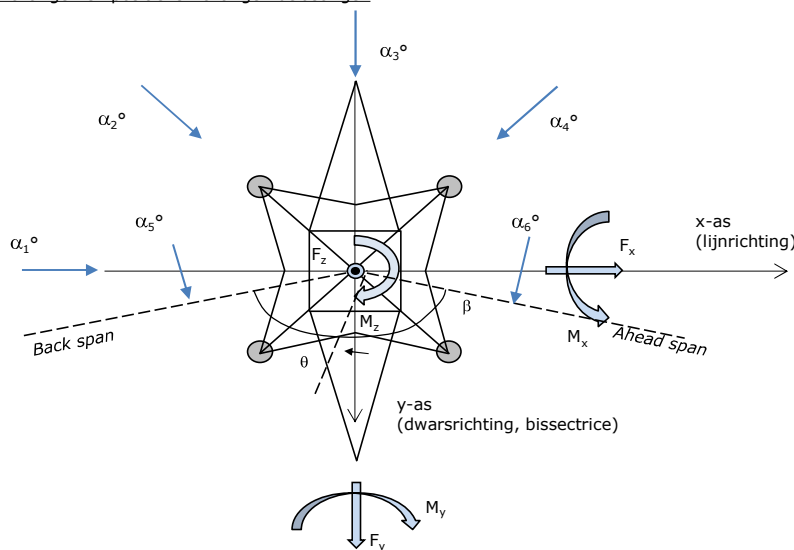

Beschouwd aantal windrichtingen

1a	6
3	6
4	1
6	1
Overig	1

Project: RLL-TLB380
 Tower: EA-3_co
 Number: 1025

Geleiderafval

		SPLS - torsie		SPLS - Enkelzijdige trek		5a - geleiderbreuk	
		Aanw.	Afw.	Aanw.	Afw.	Aanw.	Afw.
Circuit 1	380ct1f1	1	0	1	0	1	0
Circuit 1	380ct1f2	1	0	1	0	1	0
Circuit 1	380ct1f3	1	0	1	0	1	0
Circuit 2	380ct2f1	0	1	1	0	1	0
Circuit 2	380ct2f2	0	1	1	0	1	0
Circuit 2	380ct2f3	0	1	1	0	1	0
Circuit 3	150ct3f1	1	0	1	0	1	0
Circuit 3	150ct3f2	1	0	1	0	1	0
Circuit 3	150ct3f3	1	0	1	0	1	0
Circuit 4	150ct4f1	0	1	1	0	1	0
Circuit 4	150ct4f2	0	1	1	0	1	0
Circuit 4	150ct4f3	0	1	1	0	1	0
Bliksemdraad 1	b11	1	0	1	0	1	0
Bliksemdraad 2	b12	0	1	1	0	1	0

Belastingsituaties SPLS

Beschouwde situaties SPLS: 1 t/m 6, alle mogelijke situaties.

Principe belastingssituaties:

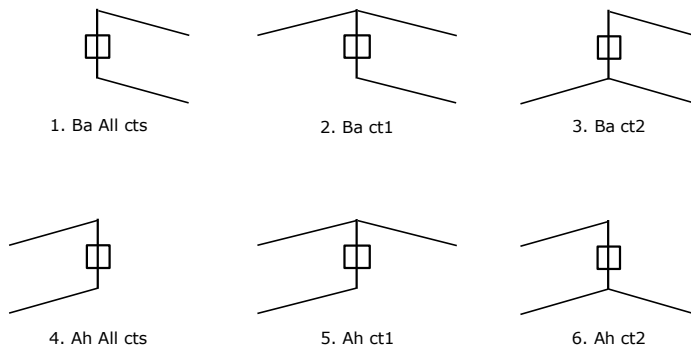

Belastingsituaties 5a. Geleiderbreuk

Beschouwde situaties geleiderbreuk 5a: 1 en 2, alle mogelijke situaties.

Principe belastingssituaties:

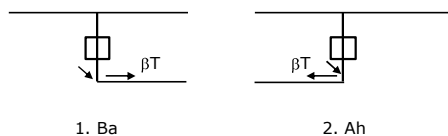

Project: RLL-TLB380
 Tower: EA-3_co
 Number: 1025

Belastingsituaties 6. Bouw- en onderhoud

Onder 6a wordt de belasting door aanwezigheid lijnwagen of lijnfiets in combinatie met puntlast op traverse in rekening gebracht. Combinatie 6b bevat geen belastingen in geleider of op traverse. Deze combinatie is toegevoegd om te kunnen combineren met separate controle bordessen etc. De situaties worden in ULS en in iedere SPLS-situatie (in geval van hoekmast) toegepast.

	Fase	Bliksem
Lijnwagen	4,0 kN	2,0 kN
Puntlast op traverse	1,0 kN	1,0 kN

Beschouwde situaties bouw- en onderhoud 6a: 1 t/m 4, alle mogelijke situaties.

Aanwezigheid lijnwagen: Circuit, belasting tegelijk aanwezig in alle geleiders per circuit.

Principe belastingssituaties:

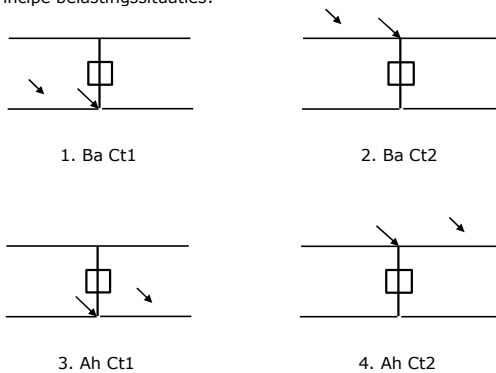

Belastingsituaties 8. Lijndansen als statische belasting

Geleider		
Steunmast fase	0,866 W	1,5 W
Steunmast bliksem	1,5 EDS	1,5 W
Hoekmast fase en bliksem	1,5 EDS	1,5 W

Beschouwde situaties lijndansen 8: 1 en 2, alle mogelijke situaties.

Belasting tegelijk aanwezig in alle geleiders van het circuit.

Principe belastingssituaties:

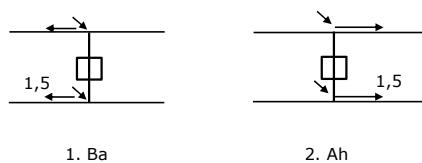

Belastingcombinatie 8. Lijndansen als dynamische belasting

Alleen van toepassing op hoek- en eindmasten

Belasting bestaat uit EDS-trekbelasting in één van de geleiders aan één zijde van de mast

Door gebruiker via het belastingspectrum van tabel 4.11/NL.1 om te zetten naar spanningspectrum

Project: RLL-TLB380
 Tower: EA-3_co
 Number: 1025

Mastconstructie

Eigenschappen

Masttype	Eindmast ahead afwezig	
Mastbenaming	EA-3_co	
Voetplaat t.o.v. maaiveld	0,5 m	
Masthoogte t.o.v. voetplaat	50,1 m	
Gewicht mast	1024,8 kN	
<i>Breedte en helling mast bij fundatie</i>	x-ri.	y-ri.
Pootsprei	11,60	11,60 m
Helling van de randstijl	0,190	0,190 -
Factor spatkracht	1,1	1,1 -

Berekening windbelasting

Dynamische invloed G_T	1,00 (<i>Masthoogte < 60 m</i>)
Windbelasting overhoeks op mastlichaam evenredig met:	$(A1C1\sin^2(\phi)+A2C2\cos^2(\phi))$
Windbelasting overhoeks op traverse evenredig met:	$(A1C1\sin^2(\phi)+A2C2\cos^2(\phi))$
Vergroting wind overhoeks mastlichaam	$(1+0,2\sin^2(2\phi))$
Vergroting wind overhoeks traverse	$(1+0,2\sin^2(2\phi))$
Factor wind evenwijdig t.o.v. haaks op traverse	0,4

Eigenschappen mastsecties langsrichting (vooraanzicht, yz-vlak)

Omschrijving	h [m]	b ₁ [m]	b ₂ [m]	Δh [m]	Δ _x [m]	A ₀ [m ²]	A ₁ [m ²]	χ = A ₁ /A ₀ [-]	C _t
Broekstuk	15,90	11,60	5,56	15,90	0,190	136,44	32,46	0,24	2,77
Eerste tussenstuk	19,20	5,56	5,23	3,30	0,050	17,80	7,01	0,39	2,24
Tweede tussenstuk	25,50	5,23	4,60	6,30	0,050	30,96	11,79	0,38	2,27
Bovenstuk 1	35,00	4,60	3,65	9,50	0,050	39,19	12,78	0,33	2,44
Bovenstuk 2	48,40	3,65	2,31	13,40	0,050	39,93	13,61	0,34	2,40
Topstuk	50,10	2,31		1,70		1,96	0,33	0,17	3,08
Ondertraverse	25,50	13,70		3,10		21,24	6,53	0,31	2,51
Middentraverse	35,00	13,00		3,20		20,80	6,45	0,31	2,50
Boventraverse	45,00	14,88		5,10		37,93	7,57	0,20	2,93

Eigenschappen mastsecties dwarsrichting (zijaanzicht, xz-vlak)

Omschrijving	h [m]	b ₁ [m]	b ₂ [m]	Δh [m]	Δ _x [m]	A ₀ [m ²]	A ₁ [m ²]	χ = A ₁ /A ₀ [-]	C _t
Broekstuk	15,90	11,60	5,56	15,90	0,190	136,44	32,46	0,24	2,77
Eerste tussenstuk	19,20	5,56	5,23	3,30	0,050	17,80	7,01	0,39	2,24
Tweede tussenstuk	25,50	5,23	4,60	6,30	0,050	30,96	11,79	0,38	2,27
Bovenstuk 1	35,00	4,60	3,65	9,50	0,050	39,19	12,78	0,33	2,44
Bovenstuk 2	48,40	3,65	2,31	13,40	0,050	39,93	13,61	0,34	2,40
Topstuk	50,10	2,31		1,70		1,96	0,33	0,17	3,08
Ondertraverse	25,50	13,70		3,10		21,24	6,53	0,31	2,51
Middentraverse	35,00	13,00		3,20		20,80	6,45	0,31	2,50
Boventraverse	45,00	14,88		5,10		37,93	7,57	0,20	2,93

NB: oppervlakte traverse dwarsrichting van de tabel wordt in berekening gereduceerd.
 NB: oppervlakte traverse per zijde, dus helft van totaal van twee traverse.

Project: RLL-TLB380
 Tower: EA-3_co
 Number: 1025

Windoppervlak feeders telecominstallaties

Onderdeel	A (m ² /m)	Factor	Δh	A ₁
Broekstuk	0,14	0,71	15,9	1,6
Eerste tussenstuk	0,14	0,71	3,3	0,3
Tweede tussenstuk	0,14	0,71	6,3	0,6
Bovenstuk 1	0,14	0,71	9,5	0,9
Bovenstuk 2				

Invoer antennes

Omschrijving	A (m ²)	h (m)	C _i (m)
Antenne top			
Antenne o.t.	4,7	31,7	1,5

Belastingen mastsectie langsrichting (x-richting) per windrichting

Omschrijving	P _w [kN/m ²]	F _{x1} [kN]	F _{x2} [kN]	F _{x3} [kN]	F _{x4} [kN]	h _{ef} [m]	M _{y1} [kNm]	M _{y2} [kNm]	M _{y3} [kNm]	M _{y4} [kNm]
Broekstuk	0,70	63,1	53,5	0,0	-53,5	8,0	501,4	425,5	0,0	-425,5
Eerste tussenstuk	0,84	13,2	11,2	0,0	-11,2	17,6	231,8	196,7	0,0	-196,7
Tweede tussenstuk	0,91	24,3	20,6	0,0	-20,6	22,4	543,6	461,2	0,0	-461,2
Bovenstuk 1	1,00	31,1	26,4	0,0	-26,4	30,3	940,5	798,0	0,0	-798,0
Bovenstuk 2	1,08	35,3	29,9	0,0	-29,9	41,7	1471,5	1248,6	0,0	-1248,6
Topstuk	1,13	1,1	1,0	0,0	-1,0	49,3	56,4	47,8	0,0	-47,8
Ondertraverse	0,95	31,3	18,6	0,0	-18,6	26,5	829,3	492,6	0,0	-492,6
Middentraverse	1,04	33,5	19,9	0,0	-19,9	36,1	1209,3	718,3	0,0	-718,3
Boventraverse	1,12	49,5	29,4	0,0	-29,4	46,7	2311,5	1372,9	0,0	-1372,9
Totaal		282,4	210,5	0,0	-210,5		8095,2	5761,7	0,0	-5761,7

Belastingen mastsectie dwarsrichting (y-richting) per windrichting

Omschrijving	P _w [kN/m ²]	F _{y1} [kN]	F _{y2} [kN]	F _{y3} [kN]	F _{y4} [kN]	h _{ef} [m]	M _{x1} [kNm]	M _{x2} [kNm]	M _{x3} [kNm]	M _{x4} [kNm]
Broekstuk	0,70	0,0	53,5	63,1	53,5	8,0	0,0	425,5	501,4	425,5
Eerste tussenstuk	0,84	0,0	11,2	13,2	11,2	17,6	0,0	196,7	231,8	196,7
Tweede tussenstuk	0,91	0,0	20,6	24,3	20,6	22,4	0,0	461,2	543,6	461,2
Bovenstuk 1	1,00	0,0	26,4	31,1	26,4	30,3	0,0	798,0	940,5	798,0
Bovenstuk 2	1,08	0,0	29,9	35,3	29,9	41,7	0,0	1248,6	1471,5	1248,6
Topstuk	1,13	0,0	1,0	1,1	1,0	49,3	0,0	47,8	56,4	47,8
Ondertraverse	0,95	0,0	18,6	12,5	18,6	26,5	0,0	492,6	331,7	492,6
Middentraverse	1,04	0,0	19,9	13,4	19,9	36,1	0,0	718,3	483,7	718,3
Boventraverse	1,12	0,0	29,4	19,8	29,4	46,7	0,0	1372,9	924,6	1372,9
Totaal		0,0	210,5	213,8	210,5		0,0	5761,7	5485,2	5761,7

Resulterende belastingen vanuit mastconstructie incl. antenne zonder geleiders niveau fundatie (kar. waarde)

Belasting / windrichting	F _x [kN]	F _y [kN]	F _z [kN]	M _x [kNm]	M _y [kNm]	M _z [kNm]
Permanente belasting	0	0	1025	0	0	0
Windrichting 0°	289	0	0	0	8320	0
Windrichting 45°	216	216	0	5920	5920	0
Windrichting 90°	0	221	0	5710	0	0
Windrichting 135°	-216	216	0	5920	-5920	0

Project: RLL-TLB380
 Tower: EA-3_co
 Number: 1025

Tussenresultaten geleiderbelastingen

Geleiders back

Circuit	Geleider	Diameter [mm]	A [mm ²]	G [N/m]	E [N/mm ²]	αT [-]
Circuit 1	AAAC-AL7 620	32,4	621,0	17,71	56000	2,30E-05
Circuit 2	AAAC-AL7 620	32,4	621,0	17,71	56000	2,30E-05
Circuit 3	AAAC-AL7 620	32,4	621,0	17,71	56000	2,30E-05
Circuit 4	AAAC-AL7 620	32,4	621,0	17,71	56000	2,30E-05
Bliksemdraad 1	AACSR 241-AL3-39-A20SA	21,8	281,0	9,38	70165	1,97E-05
Bliksemdraad 2	OPGW AFL-226/38	21,7	264,0	9,13	72000	1,98E-05

Geleiders ahead

Circuit	Geleider	Diameter [mm]	A [mm ²]	G [N/m]	E [N/mm ²]	αT [-]
Circuit 1	AAAC-AL7 620	32,4	621,0	17,71	56000	2,30E-05
Circuit 2	AAAC-AL7 620	32,4	621,0	17,71	56000	2,30E-05
Circuit 3	AAAC-AL7 620	32,4	621,0	17,71	56000	2,30E-05
Circuit 4	AAAC-AL7 620	32,4	621,0	17,71	56000	2,30E-05
Bliksemdraad 1	AACSR 241-AL3-39-A20SA	21,8	281,0	9,38	70165	1,97E-05
Bliksemdraad 2	OPGW AFL-226/38	21,7	264,0	9,13	72000	1,98E-05

Verticale belasting back

Circuit	Bundel [-]	Toeslag [%]	$w_{z,G}$ [N/m]	IJsgebied	Formule	$w_{z,ijs}$ [N/m]	$w_{z,ijs,bundel}$ [N/m]
Circuit 1	4	3	73,0	B	4+0,2d	10,5	41,9
Circuit 2	4	3	73,0	B	4+0,2d	10,5	41,9
Circuit 3	2	3	36,5	B	4+0,2d	10,5	21,0
Circuit 4	2	3	36,5	B	4+0,2d	10,5	21,0
Bliksemdraad 1	1	2	9,6	A	15+0,4d	23,7	23,7
Bliksemdraad 2	1	2	9,3	A	15+0,4d	23,7	23,7

Verticale belasting ahead

Circuit	Bundel [-]	Toeslag [%]	$w_{z,G}$ [N/m]	IJsgebied	Formule	$w_{z,ijs}$ [N/m]	$w_{z,ijs,bundel}$ [N/m]
Circuit 1	4	3	0,0	B	4+0,2d	0,0	0,0
Circuit 2	4	3	0,0	B	4+0,2d	0,0	0,0
Circuit 3	2	3	0,0	B	4+0,2d	0,0	0,0
Circuit 4	2	3	0,0	B	4+0,2d	0,0	0,0
Bliksemdraad 1	1	2	0,0	A	15+0,4d	0,0	0,0
Bliksemdraad 2	1	2	0,0	A	15+0,4d	0,0	0,0

Isolatoren

Geleider	$G_{isolator}$ [kN]	Aantal	$F_{v,iso}$ [kN]	Lengte [m]	Windopp. [m ²]	Windhoogte [m]	Stuwdruk [kN/m ²]	Vormfactor [-]	$F_{h,iso}$ [kN]
380ct1f1	3,00	1	3	6,5	1,1	45,50	1,11	1,2	1,46
380ct1f2	3,00	1	3	6,5	1,1	35,50	1,04	1,2	1,37
380ct1f3	3,00	1	3	6,5	1,1	26,00	0,95	1,2	1,25
380ct2f1	3,00	1	3	6,5	1,1	45,50	1,11	1,2	1,46
380ct2f2	3,00	1	3	6,5	1,1	35,50	1,04	1,2	1,37
380ct2f3	3,00	1	3	6,5	1,1	26,00	0,95	1,2	1,25
150ct3f1	2,00	1	2	3,5	0,8	45,50	1,11	1,2	1,06
150ct3f2	2,00	1	2	3,5	0,8	35,50	1,04	1,2	0,99
150ct3f3	2,00	1	2	3,5	0,8	26,00	0,95	1,2	0,91
150ct4f1	2,00	1	2	3,5	0,8	45,50	1,11	1,2	1,06
150ct4f2	2,00	1	2	3,5	0,8	35,50	1,04	1,2	0,99
150ct4f3	2,00	1	2	3,5	0,8	26,00	0,95	1,2	0,91
bl1	0,10	1	0,1	0,2	0,1	50,60	1,14	1,2	0,14
bl2	0,10	1	0,1	0,2	0,1	50,60	1,14	1,2	0,14

Project: RLL-TLB380
 Tower: EA-3_co
 Number: 1025

Windbelasting back

Geleider	hoogte		G _{c,dwars}	G _{c,trek}	C _c	d _{toeslag}	W _y	W _{y,vak}	D _{jjs,toeslag}	W _{y,jjs}	W _{y,jjs,vak}
	wind	Stuwdruk									
	[m]	[kN/m ²]	[-]	[-]	[-]	[mm]	[N/m]	[N/m]	[mm]	[N/m]	[N/m]
380ct1f1	47,1	1,12	0,61	0,67	0,96	33,37	88,2	97,0	51,8	170,4	187,4
380ct1f2	37,1	1,05	0,59	0,65	0,99	33,37	82,0	90,3	51,8	155,0	170,5
380ct1f3	27,6	0,97	0,57	0,63	1,01	33,37	74,5	82,0	51,8	137,1	150,9
380ct2f1	47,1	1,12	0,61	0,67	0,96	33,37	88,2	97,0	51,8	170,4	187,4
380ct2f2	37,1	1,05	0,59	0,65	0,99	33,37	82,0	90,3	51,8	155,0	170,5
380ct2f3	27,6	0,97	0,57	0,63	1,01	33,37	74,5	82,0	51,8	137,1	150,9
150ct3f1	47,1	1,12	0,61	0,67	0,96	33,37	44,1	48,5	51,8	85,2	93,7
150ct3f2	37,1	1,05	0,59	0,65	0,99	33,37	41,0	45,1	51,8	77,5	85,3
150ct3f3	27,6	0,97	0,57	0,63	1,01	33,37	37,3	41,0	51,8	68,5	75,5
150ct4f1	47,1	1,12	0,61	0,67	0,96	33,37	44,1	48,5	51,8	85,2	93,7
150ct4f2	37,1	1,05	0,59	0,65	0,99	33,37	41,0	45,1	51,8	77,5	85,3
150ct4f3	27,6	0,97	0,57	0,63	1,01	33,37	37,3	41,0	51,8	68,5	75,5
bl1	52,2	1,15	0,62	0,68	1,18	22,24	18,7	20,6	63,1	54,0	59,4
bl2	52,2	1,15	0,62	0,68	1,18	22,13	18,7	20,5	63,0	53,9	59,3

Windbelasting ahead

Geleider	hoogte		G _{c,dwars}	G _{c,trek}	C _c	d _{toeslag}	W _y	W _{y,vak}	D _{jjs,toeslag}	W _{y,jjs}	W _{y,jjs,vak}
	wind	Stuwdruk									
	[m]	[kN/m ²]	[-]	[-]	[-]	[mm]	[N/m]	[N/m]	[mm]	[N/m]	[N/m]
380ct1f1	41,1	1,08	0,60	0,66	0,98	33,37	0,0	0,0	33,4	0,0	0,0
380ct1f2	31,1	1,00	0,58	0,64	1,00	33,37	0,0	0,0	33,4	0,0	0,0
380ct1f3	21,6	0,90	0,55	0,61	1,04	33,37	0,0	0,0	33,4	0,0	0,0
380ct2f1	41,1	1,08	0,60	0,66	0,98	33,37	0,0	0,0	33,4	0,0	0,0
380ct2f2	31,1	1,00	0,58	0,64	1,00	33,37	0,0	0,0	33,4	0,0	0,0
380ct2f3	21,6	0,90	0,55	0,61	1,04	33,37	0,0	0,0	33,4	0,0	0,0
150ct3f1	41,1	1,08	0,60	0,66	0,98	33,37	0,0	0,0	33,4	0,0	0,0
150ct3f2	31,1	1,00	0,58	0,64	1,00	33,37	0,0	0,0	33,4	0,0	0,0
150ct3f3	21,6	0,90	0,55	0,61	1,04	33,37	0,0	0,0	33,4	0,0	0,0
150ct4f1	41,1	1,08	0,60	0,66	0,98	33,37	0,0	0,0	33,4	0,0	0,0
150ct4f2	31,1	1,00	0,58	0,64	1,00	33,37	0,0	0,0	33,4	0,0	0,0
150ct4f3	21,6	0,90	0,55	0,61	1,04	33,37	0,0	0,0	33,4	0,0	0,0
bl1	46,2	1,11	0,61	0,67	1,19	22,24	0,0	0,0	22,2	0,0	0,0
bl2	46,2	1,11	0,61	0,67	1,19	22,13	0,0	0,0	22,1	0,0	0,0

NB: belastingen w_v gelden voor bundel

Project: RLL-TLB380
 Masttype: EA-3_co
 Mast: 1025

Auteur: TBR
 Versie: v12.0

Geleiderbelastingen

Uitgangspunten
 Betrouwbaarheidsniveau Nieuwbouw CC2
 Referentieperiode 50 jaar

ULS (bezwijksterkte)		NEN-EN50341-2-15:2019							
Belastingsgeval	omschrijving	Temp °C	γ_G		γ_Q			γ_a A_k	
			$G_{k,mast}$	$G_{k,geleider}$	Q_{pk}	Q_{wk}	Q_{ik}		
ULS 1a	Wind	10°	1,20	1,20	0,00	1,50	0,00	0,0	
ULS 1a_0,9	Wind 0,9Gk alleen mast	10°	0,90	1,20	0,00	1,50	0,00	0,0	
ULS 1a_0,9_0,9	Wind 0,9Gk ook geleider	10°	0,90	0,90	0,00	1,50	0,00	0,0	
ULS 3	Wind+ijs	-5°	1,20	1,20	0,00	0,45	1,50	0,0	
ULS 3_0,9	Wind+ijs 0,9	-5°	0,90	1,20	0,00	0,45	1,50	0,0	
ULS 4	Koude+wind	-20°	1,20	1,20	0,00	0,30	0,00	0,0	
ULS 4_0,9	Koude+wind 0,9	-20°	0,90	1,20	0,00	0,30	0,00	0,0	
ULS 5a	Torsiebelastingen	10°	1,00	1,00	1,00	0,00	0,00	1,0	
ULS 5b	Longitudinale belastingen	10°	1,00	1,00	0,00	0,00	0,00	1,0	
ULS 6	Bouw en onderhoud	5°	1,20	1,20	1,50	0,30	0,00	0,0	
ULS 6_0,9	Bouw en onderhoud	5°	1,20	1,20	0,00	0,30	0,00	0,0	
ULS 7	Permanent	10°	1,35	1,35	0,00	0,00	0,00	0,0	
ULS 8	Special	10°	1,00	1,00	0,00	0,00	0,00	1,0	
SPLS (Bezwijksterkte, enkel voor hoekmasten: afwezigheid geleiders)				γ_G G_k	γ_Q Q_{pk} Q_{wk} Q_{ik}			A_k	
SPLS 1a	Wind	10°	1,20	1,20	0,0	0,78	0,00	0,0	
SPLS 1a_0,9	Wind 0,9	10°	0,90	1,20	0,0	0,78	0,00	0,0	
SPLS 1a_0,9_0,9	Wind 0,9	10°	0,90	0,90	0,0	0,78	0,00	0,0	
SPLS 3	Wind+ijs	-5°	1,20	1,20	0,0	0,36	0,34	0,0	
SPLS 3_0,9	Wind+ijs 0,9	-5°	0,90	1,20	0,0	0,36	0,34	0,0	
SPLS 4	Koude+wind	-20°	1,20	1,20	0,0	0,24	0,00	0,0	
SPLS 4_0,9	Koude+wind 0,9	-20°	0,90	1,20	0,0	0,24	0,00	0,0	
SPLS 6	Bouw en onderhoud	5°	1,20	1,20	1,2	0,24	0,0	0,0	
SPLS 6_0,9	Bouw en onderhoud	5°	1,20	1,20	0,0	0,24	0,0	0,0	
SLS (controle van de vervormingen, vermoeiing, EDS)				G_k	Q_{pk}	Q_{wk}	Q_{ik}	A_k	
SLS 1a	Wind	10°	1,00	1,00	0,0	1,00	0,0	0,0	
SLS 3	Wind+ijs	-5°	1,00	1,00	0,0	0,30	1,00	0,0	
SLS 4	Wind	-20°	1,00	1,00	0,0	0,20	0,0	0,0	
SLS 6	Bouw en onderhoud	5°	1,00	1,00	0,0	0,20	0,0	0,0	
SLS 7	PB (EDS, geen wind)	10°	1,00	1,00	0,0	0,00	0,0	0,0	

Aantal windrichtingen 6
 Aantal belastingcombinaties ULS 100
 Aantal belastingcombinaties SPLS 246
 Aantal belastingcombinaties SLS 15
 Aantal knooplasten 12274

Project: RLL-TLB380
 Masttype: EA-3_co
 Mast: 1025

Samenvattingstabellen geleiderbelastingen

In de onderstaande vier tabellen is weergegeven:

- De maximale geleiderbelasting in het globale assenstelsel, gesplitst in aandeel van back en ahead span
- De gecombineerde geleiderbelasting (Ba+Ah) in het globale assenstelsel met in het lokale assenstelsel de maximaal optredende trekkracht. Componenten Fx en Fy als absolute waarde
- De alledaagse (EDS) waarden van de gecombineerde geleiderbelastingen (Ba+Ah) met bijbehorende trekkrachten
- Controle op uplift, waar een negatieve waarde duidt op uplift

Maximale waarden voor back en ahead span

Geleider	Fx_ba [kN]	Fx_ah [kN]	Fy_ba [kN]	Fy_ah [kN]	Fz_ba [kN]	Fz_ah [kN]
bl1	-67,3	0,0	5,8	0,0	11,0	0,0
380ct1f1	-270,4	0,0	28,7	0,0	39,8	0,0
380ct1f2	-266,2	0,0	26,8	0,0	39,7	0,0
380ct1f3	-261,8	0,0	24,5	0,0	39,6	0,0
Post-isolato	0,0	0,0	0,0	0,0	0,0	
Post-isolato	0,0	0,0	0,0	0,0	0,0	
Post-isolato	0,0	0,0	0,0	0,0	0,0	
380ct2f1	-270,4	0,0	28,7	0,0	39,8	0,0
380ct2f2	-266,2	0,0	26,8	0,0	39,7	0,0
380ct2f3	-261,8	0,0	24,5	0,0	39,6	0,0
150ct3f1	-135,2	0,0	14,8	0,0	21,3	0,0
150ct3f2	-133,1	0,0	13,9	0,0	21,3	0,0
150ct3f3	-130,9	0,0	12,8	0,0	21,3	0,0
150ct4f1	-135,2	0,0	14,8	0,0	21,3	0,0
150ct4f2	-133,1	0,0	13,9	0,0	21,3	0,0
150ct4f3	-130,9	0,0	12,8	0,0	21,3	0,0
bl2	-66,4	0,0	5,8	0,0	11,0	0,0
Post-isolato	0,0	0,0	0,0	0,0	0,0	
Post-isolato	0,0	0,0	0,0	0,0	0,0	
Post-isolato	0,0	0,0	0,0	0,0	0,0	

Min. Weight span (m)

Weight spar Combinatie1

Geleider	SLS 1a	SLS 4	SLS 7
bl1	240,5	249,2	240,5
380ct1f1	240,5	248,3	240,5
380ct1f2	240,5	248,1	240,5
380ct1f3	240,5	248,0	240,5
Post-isolator 1			
Post-isolator 2			
Post-isolator 3			
380ct2f1	240,5	248,3	240,5
380ct2f2	240,5	248,1	240,5
380ct2f3	240,5	248,0	240,5
150ct3f1	240,5	248,3	240,5
150ct3f2	240,5	248,1	240,5
150ct3f3	240,5	248,0	240,5
150ct4f1	240,5	248,3	240,5
150ct4f2	240,5	248,1	240,5
150ct4f3	240,5	248,0	240,5
bl2	240,5	249,3	240,5
Post-isolator 4			
Post-isolator 5			
Post-isolator 6			

Max. Weight span (m)

Weight spar Combinatie1

Geleider	ULS 1a	ULS 3
bl1	289,3	232,2
380ct1f1	265,6	240,4
380ct1f2	263,1	239,8
380ct1f3	260,0	239,2
Post-isolator 1		
Post-isolator 2		
Post-isolator 3		
380ct2f1	265,6	240,4
380ct2f2	263,1	239,8
380ct2f3	260,0	239,2
150ct3f1	265,6	240,4
150ct3f2	263,1	239,8
150ct3f3	260,0	239,2
150ct4f1	265,6	240,4
150ct4f2	263,1	239,8
150ct4f3	260,0	239,2
bl2	290,6	232,0
Post-isolator 4		
Post-isolator 5		
Post-isolator 6		

Omhullende weight span over alle combinaties (incl. 0,9 combinaties)

Voor alle geleiders	Wind / Weight span verhouding
Max. weight span	289,3 m / 0,723 -
Min. weight span	-33,3 m / -0,083 -

Project: RLL-TLB380
 Masttype: EA-3_co
 Mast: 1025

Maximale waarden back+ahead span Maximale waarden trekkracht geleider

Geleider	Maximale waarden back+ahead span		Maximale waarden trekkracht geleider		
	Fx [kN]	Fy [kN]	Fz [kN]	Ft_ba [kN]	Ft_ah [kN]
bl1	67,3	5,8	11,0	-67,3	0,0
380ct1f1	270,4	28,7	39,8	-270,4	0,0
380ct1f2	266,2	26,8	39,7	-266,2	0,0
380ct1f3	261,8	24,5	39,6	-261,8	0,0
Post-isolato	4,1	4,1	6,8	0,0	
Post-isolato	4,5	4,5	6,8	0,0	
Post-isolato	4,8	4,8	6,8	0,0	
380ct2f1	270,4	28,7	39,8	-270,4	0,0
380ct2f2	266,2	26,8	39,7	-266,2	0,0
380ct2f3	261,8	24,5	39,6	-261,8	0,0
150ct3f1	135,2	14,8	21,3	-135,2	0,0
150ct3f2	133,1	13,9	21,3	-133,1	0,0
150ct3f3	130,9	12,8	21,3	-130,9	0,0
150ct4f1	135,2	14,8	21,3	-135,2	0,0
150ct4f2	133,1	13,9	21,3	-133,1	0,0
150ct4f3	130,9	12,8	21,3	-130,9	0,0
bl2	66,4	5,8	11,0	-66,4	0,0
Post-isolato	4,1	4,1	6,8	0,0	
Post-isolato	4,5	4,5	6,8	0,0	
Post-isolato	4,8	4,8	6,8	0,0	

EDS-belastingen geleiders

Geleider	EDS-belastingen geleiders				
	Fx [kN]	Fy [kN]	Fz [kN]	Ft_ba [kN]	Ft_ah [kN]
bl1	0,0	0,0	2,4	-17,2	0,0
380ct1f1	0,0	0,0	20,5	-131,3	0,0
380ct1f2	0,0	0,0	20,5	-131,3	0,0
380ct1f3	0,0	0,0	20,5	-131,3	0,0
Post-isolato	0,0	0,0	5,0	0,0	
Post-isolato	0,0	0,0	5,0	0,0	
Post-isolato	0,0	0,0	5,0	0,0	
380ct2f1	0,0	0,0	20,5	-131,3	0,0
380ct2f2	0,0	0,0	20,5	-131,3	0,0
380ct2f3	0,0	0,0	20,5	-131,3	0,0
150ct3f1	0,0	0,0	10,8	-65,7	0,0
150ct3f2	0,0	0,0	10,8	-65,7	0,0
150ct3f3	0,0	0,0	10,8	-65,7	0,0
150ct4f1	0,0	0,0	10,8	-65,7	0,0
150ct4f2	0,0	0,0	10,8	-65,7	0,0
150ct4f3	0,0	0,0	10,8	-65,7	0,0
bl2	0,0	0,0	2,3	-16,8	0,0
Post-isolato	0,0	0,0	5,0	0,0	
Post-isolato	0,0	0,0	5,0	0,0	
Post-isolato	0,0	0,0	5,0	0,0	

Controle uplift SLS-wind

Combinatie: Geleider	Controle uplift SLS-wind	
	Fz_ba [kN]	Fz_ah [kN]
SLS 4		
bl1	0,0	0,0
380ct1f1	0,0	0,0
380ct1f2	0,0	0,0
380ct1f3	0,0	0,0
Post-isolato	0,0	
Post-isolato	0,0	
Post-isolato	0,0	
380ct2f1	0,0	0,0
380ct2f2	0,0	0,0
380ct2f3	0,0	0,0
150ct3f1	0,0	0,0
150ct3f2	0,0	0,0
150ct3f3	0,0	0,0
150ct4f1	0,0	0,0
150ct4f2	0,0	0,0
150ct4f3	0,0	0,0
bl2	0,0	0,0
Post-isolato	0,0	
Post-isolato	0,0	
Post-isolato	0,0	

Project: RLL-TLB380
 Masttype: EA-3_co
 Mast: 1025

ULS-fundatiebelasting combinatie 1 en 3 wind haaks op de lijn of bissectrice en EDS, vanuit geleiders

Combinatie	Combination	F_x [kN]	F_y [kN]	F_z [kN]	M_x [kNm]	M_y [kNm]	M_z [kNm]
ULS 1a_90		-2293	281	286	10197	-82628	9
ULS 1a_0,9_0		-1382	0	162	-1	-49186	9
ULS 1a_0,9_0,9_90		-2176	281	78	10197	-78555	8
ULS 3_0		-2313	0	414	-2	-83132	15
SLS 7		-1216	0	223	-1	-43270	7

ULS-fundatiebelasting combinatie 1 en 3 wind haaks op de lijn of bissectrice en EDS, totaal geleiders en mast

Combinatie	F_x [kN]	F_y [kN]	F_z [kN]	M_x [kNm]	M_y [kNm]	M_z [kNm]
ULS 1a_90	-2293	613	1516	18761	-82628	9
ULS 1a_0,9_0,9_90	-2176	613	1000	18762	-78555	8
SLS 7	-1216	0	1247	-1	-43270	7

Fundatiebelastingen, selectie belastingcombinaties op basis grootste waarde

Combinatie	F_x [kN]	F_y [kN]	F_z [kN]	M_x [kNm]	M_y [kNm]	M_z [kNm]
ULS 1a_0,9_0,9_90	-2176	613	1000	18762	-78555	8
ULS 3_90	-2529	249	1648	8063	-91182	15
SPLS 3_90 Ba Ct2	-960	119	1418	2262	-34483	10223
ULS 1a_0,9_90	-2293	613	1044	18762	-82628	9

Noot: grootste waarden kunnen in meerdere combinaties voorkomen, een combinatie is weergegeven.

Oplegreacties op fundering per randstijl

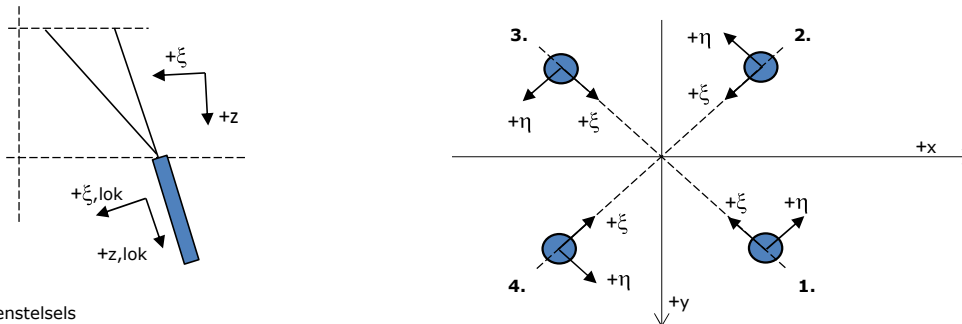

Assenstelsels

Maximale drukbelasting

Stijl	Combinatie	R_x [kN]	R_y [kN]	R_z [kN]	R_{η} [kN]	R_{ξ} [kN]	$R_{\xi,lok}$ [kN]	$R_{z,lok}$ [kN]
1	SPLS 1a_45 Ba All Cts	159	159	763	0	-225	-20	790
2	SPLS 1a_0 Ba All Cts	128	-131	626	2	-183	-15	649
3	ULS 3_105	-649	-845	3998	-138	-1057	18	4140
4	ULS 1a_90	-821	977	4748	110	-1271	5	4917

Maximale trekbelasting

Stijl	Combinatie	R_x [kN]	R_y [kN]	R_z [kN]	R_{η} [kN]	R_{ξ} [kN]	$R_{\xi,lok}$ [kN]	$R_{z,lok}$ [kN]
1	ULS 3_0,9_105	-502	-699	-3296	139	849	-36	-3413
2	ULS 1a_0,9_90	-688	843	-4108	-109	1082	-22	-4254
3	SPLS 1a_0,9_0,9_45 Ba All Cts	40	40	-193	0	56	5	-200
4	SPLS 1a_0,9_0,9_0 Ba All Cts	9	-12	-57	-2	15	-1	-59

Maximale torsiebelasting (positief)

Stijl	Combinatie	R_x [kN]	R_y [kN]	R_z [kN]	R_{η} [kN]	R_{ξ} [kN]	$R_{\xi,lok}$ [kN]	$R_{z,lok}$ [kN]
1	SPLS 3_0,9_90 Ba Ct2	61	-447	-1100	359	273	-23	-1139
2	SPLS 3_0,9_90 Ba Ct2	-433	66	-1354	259	353	-11	-1402
3	SPLS 3_90 Ba Ct2	-514	-135	1743	268	-459	10	1805
4	SPLS 3_90 Ba Ct2	-114	635	1938	368	-530	-9	2007

Maximale torsiebelasting (negatief)

Stijl	Combinatie	R_x [kN]	R_y [kN]	R_z [kN]	R_{η} [kN]	R_{ξ} [kN]	$R_{\xi,lok}$ [kN]	$R_{z,lok}$ [kN]
1	SPLS 3_0,9_90 Ba Ct1	-370	-6	-1052	-257	266	-17	-1089
2	SPLS 3_0,9_90 Ba Ct1	-2	506	-1399	-356	359	-17	-1449
3	SPLS 3_90 Ba Ct1	-51	-575	1636	-370	-443	-3	1694
4	SPLS 3_90 Ba Ct1	-577	194	2043	-270	-545	4	2115

Project: RLL-TLB380
 Masttype: EA-3_co
 Mast: 1025

Combinatie Ftrek+Fhor

Stijl	Combinatie	R _x [kN]	R _y [kN]	R _z [kN]	R _η [kN]	R _ξ [kN]	R _{ξ,lok} [kN]	R _{z,lok} [kN]
1	ULS 3_0,9_90	-499	-699	-3292	142	847	-38	-3408
2	ULS 1a_0,9_90	-688	843	-4108	-109	1082	-22	-4254
3	SPLS 1a_0,9_0,9_45 Ba All Cts	40	40	-193	0	56	5	-200
4	SPLS 1a_0,9_0,9_0 Ba All Cts	9	-12	-57	-2	15	-1	-59

Permanente belasting

Stijl	Combinatie	R _x [kN]	R _y [kN]	R _z [kN]	R _η [kN]	R _ξ [kN]	R _{ξ,lok} [kN]	R _{z,lok} [kN]
1	SLS 7	-239	-325	-1553	61	398	-19	-1608
2	SLS 7	-239	324	-1553	-60	398	-19	-1608
3	SLS 7	-369	-455	2177	-60	-583	2	2254
4	SLS 7	-369	455	2177	61	-583	2	2254

Omhullenden ongeacht stijl

Belasting	Combinatie	R _x [kN]	R _y [kN]	R _z [kN]	R _η [kN]	R _ξ [kN]	R _{ξ,lok} [kN]	R _{z,lok} [kN]
Max. druk	ULS 1a_90	-821	977	4748	110	-1271	5	4917
Max. trek	ULS 1a_0,9_90	-688	843	-4108	-109	1082	-22	-4254
Max. pos. torsie	SPLS 3_90 Ba Ct2	-114	635	1938	368	-530	-9	2007
Max. neg. torsie	SPLS 3_90 Ba Ct1	-51	-575	1636	-370	-443	-3	1694
Comb. trek+torsie	ULS 1a_0,9_90	-688	843	-4108	-109	1082	-22	-4254

Maximale trekbelasting SLS

Stijl	Combinatie	R _x [kN]	R _y [kN]	R _z [kN]	R _η [kN]	R _ξ [kN]	R _{ξ,lok} [kN]	R _{z,lok} [kN]
1	SLS 3_90	-388	-546	-2576	112	660	-32	-2668
2	SLS 3_90	-485	628	-3040	-101	787	-30	-3147
3	SLS 1a_45	-272	-379	1779	-76	-460	18	1842
4	SLS 1a_0	-292	374	1791	58	-471	10	1854

Maximale drukbelasting SLS

Stijl	Combinatie	R _x [kN]	R _y [kN]	R _z [kN]	R _η [kN]	R _ξ [kN]	R _{ξ,lok} [kN]	R _{z,lok} [kN]
1	SLS 1a_45	-141	-248	-1153	76	275	-35	-1194
2	SLS 1a_0	-162	244	-1167	-58	287	-27	-1208
3	SLS 3_90	-529	-686	3252	-111	-859	14	3367
4	SLS 3_90	-626	770	3715	102	-987	12	3847

Project: RLL-TLB380
Masttype: EA-3_co
Mast: 1025

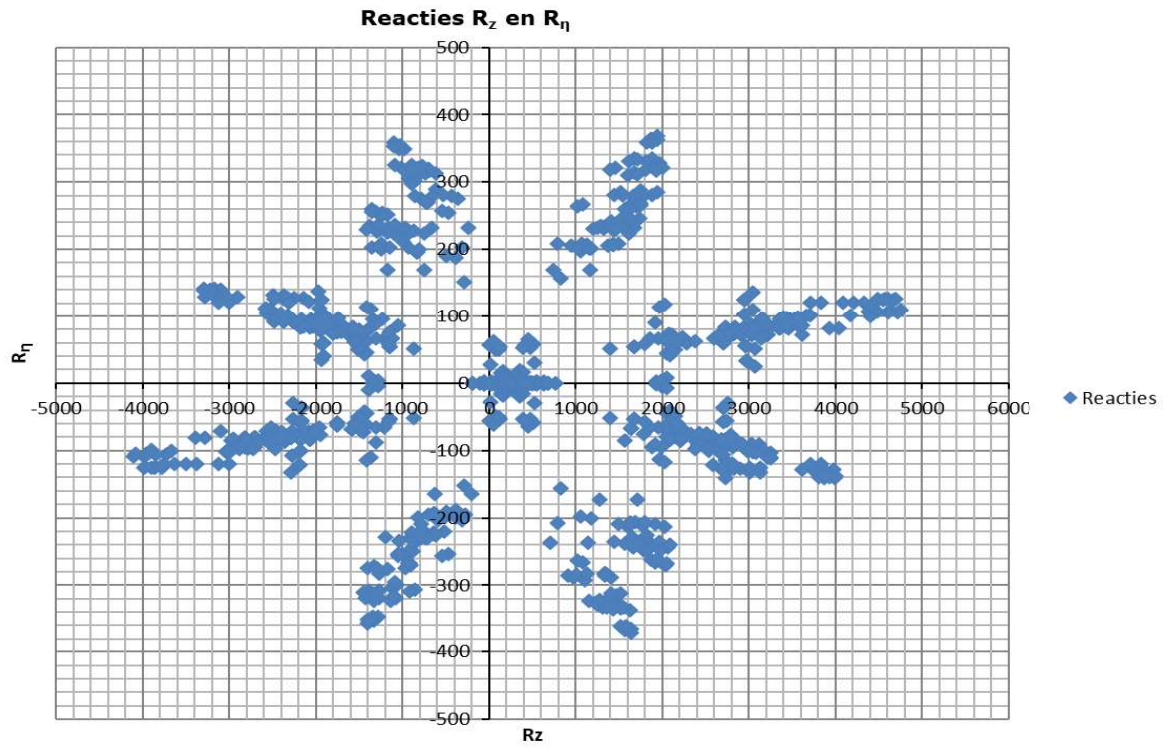

Project: RLL-TLB380
 Tower: EA-3_co (bouw)
 Number: 1025

Auteur: TBR
 Versie: v12.0

Geleiderbelastingen

Algemeen

Benaming EA-3_co (bouw)
 Masttype Eindmast ahead afwezig
 Aantal circuits 2
 Configuratie 4-circuit-dubbel verticaal
 Aantal bliksemgeleiders 1

Uitgangspunten

Norm NEN-EN50341-2-15:2019
 Gevolgklasse initieel CC2
 Betrouwbaarheidsniveau initieel Nieuwbouw
 Referentieperiode initieel 15 jaar
 Betrouwbaarheidsniveau na aanpassing n.v.t.
 15 jaar
 Windgebied III
 Windsnelheid (m/s) 24,5 m/s
 Terreincategorie II
 Reductiefactor C_{dir} 1,00
 IJsg gebied fasegeleider B
 IJsg gebied bliksemgeleider A

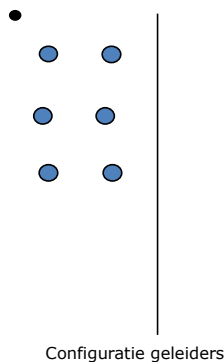

Geleiders Back

Omschrijving	Spanning	Geleider Back	Bundel Ba	IJsg gebied	Toeslag gewicht	Toeslag diameter	Intrekwaarden P_{back}
Circuit 1	380 kV	AAAC-AL7 620	4	B	3 %	3 %	1800
Circuit 2	150 kV	AAAC-AL7 620	2	B	3 %	3 %	1800
Bliksemdraad 1		AACSR 241-AL3-39-A20SA	1	A	2 %	2 %	1800

Geleiders Ahead

Omschrijving	Spanning	Geleider Ahead	Bundel Ah	IJsg gebied	Toeslag gewicht	Toeslag diameter	Intrekwaarden P_{ahead}
Circuit 1	380 kV	AAAC-AL7 620	4	B	3 %	3 %	1800
Circuit 2	150 kV	AAAC-AL7 620	2	B	3 %	3 %	1800
Bliksemdraad 1		AACSR 241-AL3-39-A20SA	1	A	2 %	2 %	1800

Isolatoren (1)

Omschrijving	Ophanging	Gewicht [kN]	Lengte [m]	Windopp. [m ²]
Circuit 1	Afspanketting	3,00	6,50	1,10
Circuit 2	Afspanketting	2,00	3,50	0,80
Bliksemdraad 1	Afspanketting	0,10	0,20	0,10

1. Eigenschappen gelden voor geheel van de isolatorset

Ophanghoogte en positie in mast

Circuits	Aanduiding	Nummer	Ophanghoogte	Aangrijppunt	Positie in mast Horizontale afstand
Circuit 1	10	380ct1f1	45,0 m	45,0 m	-10,8 m
Circuit 1	11	380ct1f2	35,0 m	35,0 m	-14,3 m
Circuit 1	12	380ct1f3	25,5 m	25,5 m	-13,3 m
Circuit 2	20	150ct2f1	45,0 m	45,0 m	-4,3 m
Circuit 2	21	150ct2f2	35,0 m	35,0 m	-7,8 m
Circuit 2	22	150ct2f3	25,5 m	25,5 m	-4,9 m
Bliksemdraad 1	1	bl1	50,1 m	50,1 m	-16,2 m

Project: RLL-TLB380
 Tower: EA-3_co (bouw)
 Number: 1025

Hoogteaanpassing naastgelegen masten (aanpassing wind- en weight span)

	Back	Ahead	
Verhoging voor windbelasting	18,0 m	6,0 m	(positief: omhoog)
Verlaging voor verticale belasting	-9,0 m	-9,0 m	(negatief: omlaag, grotere weight span)
Verlaging: Niet in 0,9EG-combinaties			

Hoogteafwijking mastbeeld naastgelegen masten en richtingsverandering t.o.v. Lijnrichting

Circuits	Aanduiding	Nummer	Hoogteverschil		Richtingsverandering	
			Δh back	Δh ahead	Δy back	Δy ahead
Circuit 1	10	380ct1f1	0,0	0,0 m	0,0	0,0 m
Circuit 1	11	380ct1f2	0,0	0,0 m	0,0	0,0 m
Circuit 1	12	380ct1f3	0,0	0,0 m	0,0	0,0 m
Circuit 2	20	150ct2f1	0,0	0,0 m	0,0	0,0 m
Circuit 2	21	150ct2f2	0,0	0,0 m	0,0	0,0 m
Circuit 2	22	150ct2f3	0,0	0,0 m	0,0	0,0 m
Bliksemendraad 1	1	bl1	0,0	0,0 m	0,0	0,0 m

Lijn- en mastgegevens

	Back	Ahead
Ruling span $\sqrt{(\Sigma L^3)/\Sigma L}$	400,0	400,0 m
Lijnhoek β	180 °	
Rotatie mast t.o.v. bissectrice θ	0 °	
Vaklengte	400	400 m
Hoogte onderkant mast t.o.v. maaiveld	0,5 m	
Beschouwde windrichtingen α_1	0 °	
Windrichtingen volgens: Geleiderbelastingen	α_2	45 °
	α_3	90 °
	α_4	135 °
	α_5	75 °
	α_6	105 °
		105 °

Windrichtingen gelden t.o.v. hoofdrichting mastconstructie, niet t.o.v. bissectrice.

Windrichtingen en positieve richtingen belastingen

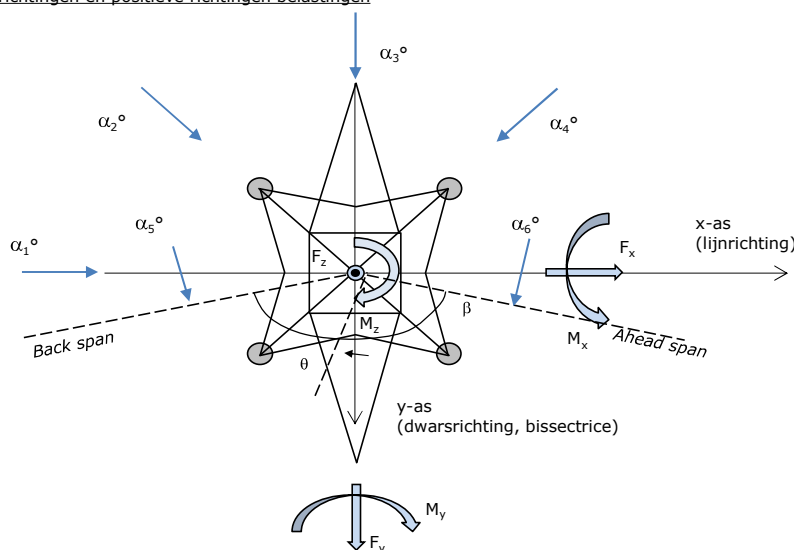

Beschouwd aantal windrichtingen

1a	6
3	6
4	1
6	1
Overig	1

Project: RLL-TLB380
 Tower: EA-3_co (bouw)
 Number: 1025

Geleiderafval

		SPLS - torsie		SPLS - Enkelzijdige trek		5a - geleiderbreuk	
		Aanw.	Afw.	Aanw.	Afw.	Aanw.	Afw.
Circuit 1	380ct1f1	1	0	1	0	1	0
Circuit 1	380ct1f2	1	0	1	0	1	0
Circuit 1	380ct1f3	1	0	1	0	1	0
Circuit 2	150ct2f1	0	1	1	0	1	0
Circuit 2	150ct2f2	0	1	1	0	1	0
Circuit 2	150ct2f3	0	1	1	0	1	0
Bliksemdraad 1	b1	1	0	1	0	1	0

Belastingsituaties SPLS

Beschouwde situaties SPLS: 1 t/m 6, alle mogelijke situaties.

Principe belastingssituaties:

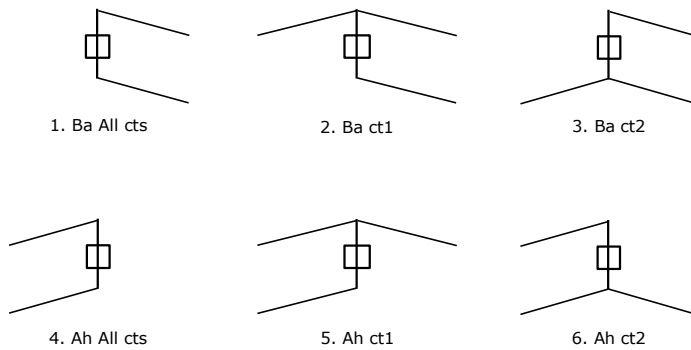

Belastingsituaties 5a. Geleiderbreuk

Beschouwde situaties geleiderbreuk 5a: 1 en 2, alle mogelijke situaties.

Principe belastingssituaties:

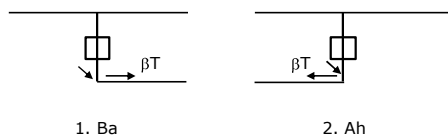

Project: RLL-TLB380
 Tower: EA-3_co (bouw)
 Number: 1025

Belastingsituaties 6. Bouw- en onderhoud

Onder 6a wordt de belasting door aanwezigheid lijnwagen of lijnfiets in combinatie met puntlast op traverse in rekening gebracht. Combinatie 6b bevat geen belastingen in geleider of op traverse. Deze combinatie is toegevoegd om te kunnen combineren met separate controle bordessen etc. De situaties worden in ULS en in iedere SPLS-situatie (in geval van hoekmast) toegepast.

	Fase	Bliksem
Lijnwagen	4,0 kN	2,0 kN
Puntlast op traverse	1,0 kN	1,0 kN

Beschouwde situaties bouw- en onderhoud 6a: 1 t/m 4, alle mogelijke situaties.

Aanwezigheid lijnwagen: Circuit, belasting tegelijk aanwezig in alle geleiders per circuit.

Principe belastingssituaties:

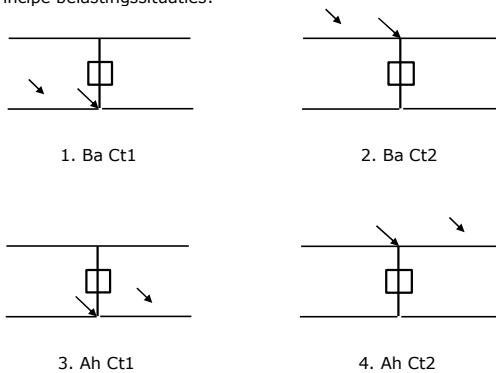

Belastingsituaties 8. Lijndansen als statische belasting

Geleider		
Steunmast fase	0,866 W	1,5 W
Steunmast bliksem	1,5 EDS	1,5 W
Hoekmast fase en bliksem	1,5 EDS	1,5 W

Beschouwde situaties lijndansen 8: 1 en 2, alle mogelijke situaties.

Belasting tegelijk aanwezig in alle geleiders van het circuit.

Principe belastingssituaties:

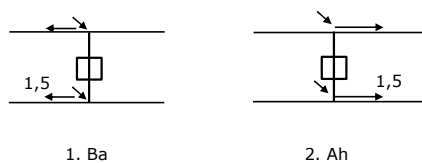

Belastingcombinatie 8. Lijndansen als dynamische belasting

Alleen van toepassing op hoek- en eindmasten

Belasting bestaat uit EDS-trekbelasting in één van de geleiders aan één zijde van de mast

Door gebruiker via het belastingsspectrum van tabel 4.11/NL.1 om te zetten naar spanningspectrum

Project: RLL-TLB380
 Tower: EA-3_co (bouw)
 Number: 1025

Mastconstructie

Eigenschappen

Masttype	Eindmast ahead afwezig	
Mastbenaming	EA-3_co (bouw)	
Voetplaat t.o.v. maaiveld	0,5 m	
Masthoogte t.o.v. voetplaat	50,1 m	
Gewicht mast	1024,8 kN	
<i>Breedte en helling mast bij fundatie</i>		
	x-ri.	y-ri.
Pootsprei	11,60	11,60 m
Helling van de randstijl	0,190	0,190 -
Factor spatkracht	1,1	1,1 -

Berekening windbelasting

Dynamische invloed G_T	1,00 (Masthoogte < 60 m)
Windbelasting overhoeks op mastlichaam evenredig met:	$(A1C1\sin^2(\phi)+A2C2\cos^2(\phi))$
Windbelasting overhoeks op traverse evenredig met:	$(A1C1\sin^2(\phi)+A2C2\cos^2(\phi))$
Vergroting wind overhoeks mastlichaam	$(1+0,2\sin^2(2\phi))$
Vergroting wind overhoeks traverse	$(1+0,2\sin^2(2\phi))$
Factor wind evenwijdig t.o.v. haaks op traverse	0,4

Eigenschappen mastsecties langsrichting (vooraanzicht, yz-vlak)

Omschrijving	h [m]	b ₁ [m]	b ₂ [m]	Δh [m]	Δ _x [m]	A ₀ [m ²]	A ₁ [m ²]	χ = A ₁ /A ₀ [-]	C _t
Broekstuk	15,90	11,60	5,56	15,90	0,190	136,44	32,46	0,24	2,77
Eerste tussenstuk	19,20	5,56	5,23	3,30	0,050	17,80	7,01	0,39	2,24
Tweede tussenstuk	25,50	5,23	4,60	6,30	0,050	30,96	11,79	0,38	2,27
Bovenstuk 1	35,00	4,60	3,65	9,50	0,050	39,19	12,78	0,33	2,44
Bovenstuk 2	48,40	3,65	2,31	13,40	0,050	39,93	13,61	0,34	2,40
Topstuk	50,10	2,31		1,70		1,96	0,33	0,17	3,08
Ondertraverse	25,50	13,70		3,10		21,24	6,53	0,31	2,51
Middentraverse	35,00	13,00		3,20		20,80	6,45	0,31	2,50
Boventraverse	45,00	14,88		5,10		37,93	7,57	0,20	2,93

Eigenschappen mastsecties dwarsrichting (zijaanzicht, xz-vlak)

Omschrijving	h [m]	b ₁ [m]	b ₂ [m]	Δh [m]	Δ _x [m]	A ₀ [m ²]	A ₁ [m ²]	χ = A ₁ /A ₀ [-]	C _t
Broekstuk	15,90	11,60	5,56	15,90	0,190	136,44	32,46	0,24	2,77
Eerste tussenstuk	19,20	5,56	5,23	3,30	0,050	17,80	7,01	0,39	2,24
Tweede tussenstuk	25,50	5,23	4,60	6,30	0,050	30,96	11,79	0,38	2,27
Bovenstuk 1	35,00	4,60	3,65	9,50	0,050	39,19	12,78	0,33	2,44
Bovenstuk 2	48,40	3,65	2,31	13,40	0,050	39,93	13,61	0,34	2,40
Topstuk	50,10	2,31		1,70		1,96	0,33	0,17	3,08
Ondertraverse	25,50	13,70		3,10		21,24	6,53	0,31	2,51
Middentraverse	35,00	13,00		3,20		20,80	6,45	0,31	2,50
Boventraverse	45,00	14,88		5,10		37,93	7,57	0,20	2,93

NB: oppervlakte traverse dwarsrichting van de tabel wordt in berekening gereduceerd.
 NB: oppervlakte traverse per zijde, dus helft van totaal van twee traveres.

Project: RLL-TLB380
 Tower: EA-3_co (bouw)
 Number: 1025

Windoppervlak feeders telecominstallaties

Onderdeel	A (m ² /m)	Factor	Δh	A ₁
Broekstuk	0,14	0,71	15,9	1,6
Eerste tussenstuk	0,14	0,71	3,3	0,3
Tweede tussenstuk	0,14	0,71	6,3	0,6
Bovenstuk 1	0,14	0,71	9,5	0,9
Bovenstuk 2				

Invoer antennes

Omschrijving	A (m ²)	h (m)	C _i (m)
Antenne top			
Antenne o.t.	4,7	31,7	1,5

Belastingen mastsectie langsrichting (x-richting) per windrichting

Omschrijving	P _w [kN/m ²]	F _{x1} [kN]	F _{x2} [kN]	F _{x3} [kN]	F _{x4} [kN]	h _{ef} [m]	M _{y1} [kNm]	M _{y2} [kNm]	M _{y3} [kNm]	M _{y4} [kNm]
Broekstuk	0,70	63,1	53,5	0,0	-53,5	8,0	501,4	425,5	0,0	-425,5
Eerste tussenstuk	0,84	13,2	11,2	0,0	-11,2	17,6	231,8	196,7	0,0	-196,7
Tweede tussenstuk	0,91	24,3	20,6	0,0	-20,6	22,4	543,6	461,2	0,0	-461,2
Bovenstuk 1	1,00	31,1	26,4	0,0	-26,4	30,3	940,5	798,0	0,0	-798,0
Bovenstuk 2	1,08	35,3	29,9	0,0	-29,9	41,7	1471,5	1248,6	0,0	-1248,6
Topstuk	1,13	1,1	1,0	0,0	-1,0	49,3	56,4	47,8	0,0	-47,8
Ondertraverse	0,95	31,3	18,6	0,0	-18,6	26,5	829,3	492,6	0,0	-492,6
Middentraverse	1,04	33,5	19,9	0,0	-19,9	36,1	1209,3	718,3	0,0	-718,3
Boventraverse	1,12	49,5	29,4	0,0	-29,4	46,7	2311,5	1372,9	0,0	-1372,9
Totaal		282,4	210,5	0,0	-210,5		8095,2	5761,7	0,0	-5761,7

Belastingen mastsectie dwarsrichting (y-richting) per windrichting

Omschrijving	P _w [kN/m ²]	F _{y1} [kN]	F _{y2} [kN]	F _{y3} [kN]	F _{y4} [kN]	h _{ef} [m]	M _{x1} [kNm]	M _{x2} [kNm]	M _{x3} [kNm]	M _{x4} [kNm]
Broekstuk	0,70	0,0	53,5	63,1	53,5	8,0	0,0	425,5	501,4	425,5
Eerste tussenstuk	0,84	0,0	11,2	13,2	11,2	17,6	0,0	196,7	231,8	196,7
Tweede tussenstuk	0,91	0,0	20,6	24,3	20,6	22,4	0,0	461,2	543,6	461,2
Bovenstuk 1	1,00	0,0	26,4	31,1	26,4	30,3	0,0	798,0	940,5	798,0
Bovenstuk 2	1,08	0,0	29,9	35,3	29,9	41,7	0,0	1248,6	1471,5	1248,6
Topstuk	1,13	0,0	1,0	1,1	1,0	49,3	0,0	47,8	56,4	47,8
Ondertraverse	0,95	0,0	18,6	12,5	18,6	26,5	0,0	492,6	331,7	492,6
Middentraverse	1,04	0,0	19,9	13,4	19,9	36,1	0,0	718,3	483,7	718,3
Boventraverse	1,12	0,0	29,4	19,8	29,4	46,7	0,0	1372,9	924,6	1372,9
Totaal		0,0	210,5	213,8	210,5		0,0	5761,7	5485,2	5761,7

Resulterende belastingen vanuit mastconstructie incl. antenne zonder geleiders niveau fundatie (kar. waarde)

Belasting / windrichting	F _x [kN]	F _y [kN]	F _z [kN]	M _x [kNm]	M _y [kNm]	M _z [kNm]
Permanente belasting	0	0	1025	0	0	0
Windrichting 0°	289	0	0	0	8320	0
Windrichting 45°	216	216	0	5920	5920	0
Windrichting 90°	0	221	0	5710	0	0
Windrichting 135°	-216	216	0	5920	-5920	0

Project: RLL-TLB380
 Tower: EA-3_co (bouw)
 Number: 1025

Tussenresultaten geleiderbelastingen

Geleiders back

Circuit	Geleider	Diameter [mm]	A [mm ²]	G [N/m]	E [N/mm ²]	αT [-]
Circuit 1	AAAC-AL7 620	32,4	621,0	17,71	56000	2,30E-05
Circuit 2	AAAC-AL7 620	32,4	621,0	17,71	56000	2,30E-05
Bliksemdraad 1	AACSR 241-AL3-39-A20SA	21,8	281,0	9,38	70165	1,97E-05

Geleiders ahead

Circuit	Geleider	Diameter [mm]	A [mm ²]	G [N/m]	E [N/mm ²]	αT [-]
Circuit 1	AAAC-AL7 620	32,4	621,0	17,71	56000	2,30E-05
Circuit 2	AAAC-AL7 620	32,4	621,0	17,71	56000	2,30E-05
Bliksemdraad 1	AACSR 241-AL3-39-A20SA	21,8	281,0	9,38	70165	1,97E-05

Verticale belasting back

Circuit	Bundel [-]	Toeslag [%]	$w_{z,G}$ [N/m]	IJsgebied	Formule	$w_{z,ijs}$ [N/m]	$w_{z,ijs,bundel}$ [N/m]
Circuit 1	4	3	73,0	B	4+0,2d	10,5	41,9
Circuit 2	2	3	36,5	B	4+0,2d	10,5	21,0
Bliksemdraad 1	1	2	9,6	A	15+0,4d	23,7	23,7

Verticale belasting ahead

Circuit	Bundel [-]	Toeslag [%]	$w_{z,G}$ [N/m]	IJsgebied	Formule	$w_{z,ijs}$ [N/m]	$w_{z,ijs,bundel}$ [N/m]
Circuit 1	4	3	0,0	B	4+0,2d	0,0	0,0
Circuit 2	2	3	0,0	B	4+0,2d	0,0	0,0
Bliksemdraad 1	1	2	0,0	A	15+0,4d	0,0	0,0

Isolatoren

Geleider	$G_{isolator}$ [kN]	Aantal	$F_{v,iso}$ [kN]	Lengte [m]	Windopp. [m ²]	Windhoogte [m]	Stuwdruk [kN/m ²]	Vormfactor [-]	$F_{h,iso}$ [kN]
380ct1f1	3,00	1	3	6,5	1,1	45,50	1,11	1,2	1,46
380ct1f2	3,00	1	3	6,5	1,1	35,50	1,04	1,2	1,37
380ct1f3	3,00	1	3	6,5	1,1	26,00	0,95	1,2	1,25
150ct2f1	2,00	1	2	3,5	0,8	45,50	1,11	1,2	1,06
150ct2f2	2,00	1	2	3,5	0,8	35,50	1,04	1,2	0,99
150ct2f3	2,00	1	2	3,5	0,8	26,00	0,95	1,2	0,91
bl1	0,10	1	0,1	0,2	0,1	50,60	1,14	1,2	0,14

Project: RLL-TLB380
 Tower: EA-3_co (bouw)
 Number: 1025

Windbelasting back

Geleider	hoogte		$G_{c,dwars}$	$G_{c,trek}$	C_c	$d_{toeslag}$	w_y	$w_{y,vak}$	$D_{ijs,toeslag}$	$w_{y,ijs}$	$w_{y,ijs,vak}$
	wind	Stuwdruk									
	[m]	[kN/m ²]	[-]	[-]	[-]	[mm]	[N/m]	[N/m]	[mm]	[N/m]	[N/m]
380ct1f1	47,1	1,12	0,61	0,67	0,96	33,37	88,2	97,0	51,8	170,4	187,4
380ct1f2	37,1	1,05	0,59	0,65	0,99	33,37	82,0	90,3	51,8	155,0	170,5
380ct1f3	27,6	0,97	0,57	0,63	1,01	33,37	74,5	82,0	51,8	137,1	150,9
150ct2f1	47,1	1,12	0,61	0,67	0,96	33,37	44,1	48,5	51,8	85,2	93,7
150ct2f2	37,1	1,05	0,59	0,65	0,99	33,37	41,0	45,1	51,8	77,5	85,3
150ct2f3	27,6	0,97	0,57	0,63	1,01	33,37	37,3	41,0	51,8	68,5	75,5
bl1	52,2	1,15	0,62	0,68	1,18	22,24	18,7	20,6	63,1	54,0	59,4

Windbelasting ahead

Geleider	hoogte		$G_{c,dwars}$	$G_{c,trek}$	C_c	$d_{toeslag}$	w_y	$w_{y,vak}$	$D_{ijs,toeslag}$	$w_{y,ijs}$	$w_{y,ijs,vak}$
	wind	Stuwdruk									
	[m]	[kN/m ²]	[-]	[-]	[-]	[mm]	[N/m]	[N/m]	[mm]	[N/m]	[N/m]
380ct1f1	41,1	1,08	0,60	0,66	0,98	33,37	0,0	0,0	33,4	0,0	0,0
380ct1f2	31,1	1,00	0,58	0,64	1,00	33,37	0,0	0,0	33,4	0,0	0,0
380ct1f3	21,6	0,90	0,55	0,61	1,04	33,37	0,0	0,0	33,4	0,0	0,0
150ct2f1	41,1	1,08	0,60	0,66	0,98	33,37	0,0	0,0	33,4	0,0	0,0
150ct2f2	31,1	1,00	0,58	0,64	1,00	33,37	0,0	0,0	33,4	0,0	0,0
150ct2f3	21,6	0,90	0,55	0,61	1,04	33,37	0,0	0,0	33,4	0,0	0,0
bl1	46,2	1,11	0,61	0,67	1,19	22,24	0,0	0,0	22,2	0,0	0,0

NB: belastingen w_v gelden voor bundel

Project: RLL-TLB380
 Masttype: EA-3_co (bouw)
 Mast: 1025

Auteur: TBR
 Versie: v12.0

Geleiderbelastingen

Uitgangspunten
 Betrouwbaarheidsniveau Nieuwbouw CC2
 Referentieperiode 15 jaar

ULS (bezwijksterkte)		NEN-EN50341-2-15:2019							
Belastingsgeval	omschrijving	Temp °C	γ_G		γ_Q			γ_a A_k	
			$G_{k,mast}$	$G_{k,geleider}$	Q_{pk}	Q_{wk}	Q_{ik}		
ULS 1a	Wind	10°	1,20	1,20	0,00	1,25	0,00	0,0	
ULS 1a_0,9	Wind 0,9Gk alleen mast	10°	0,90	1,20	0,00	1,25	0,00	0,0	
ULS 1a_0,9_0,9	Wind 0,9Gk ook geleider	10°	0,90	0,90	0,00	1,25	0,00	0,0	
ULS 3	Wind+ijs	-5°	1,20	1,20	0,00	0,38	1,07	0,0	
ULS 3_0,9	Wind+ijs 0,9	-5°	0,90	1,20	0,00	0,38	1,07	0,0	
ULS 4	Koude+wind	-20°	1,20	1,20	0,00	0,25	0,00	0,0	
ULS 4_0,9	Koude+wind 0,9	-20°	0,90	1,20	0,00	0,25	0,00	0,0	
ULS 5a	Torsiebelastingen	10°	1,00	1,00	1,00	0,00	0,00	1,0	
ULS 5b	Longitudinale belastingen	10°	1,00	1,00	0,00	0,00	0,00	1,0	
ULS 6	Bouw en onderhoud	5°	1,20	1,20	1,50	0,25	0,00	0,0	
ULS 6_0,9	Bouw en onderhoud	5°	1,20	1,20	0,00	0,25	0,00	0,0	
ULS 7	Permanent	10°	1,35	1,35	0,00	0,00	0,00	0,0	
ULS 8	Special	10°	1,00	1,00	0,00	0,00	0,00	1,0	
SPLS (Bezwijksterkte, enkel voor hoekmasten: afwezigheid geleiders)				γ_G G_k	γ_Q Q_{pk} Q_{wk} Q_{ik}			A_k	
SPLS 1a	Wind	10°	1,20	1,20	0,0	0,78	0,00	0,0	
SPLS 1a_0,9	Wind 0,9	10°	0,90	1,20	0,0	0,78	0,00	0,0	
SPLS 1a_0,9_0,9	Wind 0,9	10°	0,90	0,90	0,0	0,78	0,00	0,0	
SPLS 3	Wind+ijs	-5°	1,20	1,20	0,0	0,36	0,34	0,0	
SPLS 3_0,9	Wind+ijs 0,9	-5°	0,90	1,20	0,0	0,36	0,34	0,0	
SPLS 4	Koude+wind	-20°	1,20	1,20	0,0	0,24	0,00	0,0	
SPLS 4_0,9	Koude+wind 0,9	-20°	0,90	1,20	0,0	0,24	0,00	0,0	
SPLS 6	Bouw en onderhoud	5°	1,20	1,20	1,2	0,24	0,0	0,0	
SPLS 6_0,9	Bouw en onderhoud	5°	1,20	1,20	0,0	0,24	0,0	0,0	
SLS (controle van de vervormingen, vermoeiing, EDS)				G_k	Q_{pk}	Q_{wk}	Q_{ik}	A_k	
SLS 1a	Wind	10°	1,00	1,00	0,0	0,87	0,0	0,0	
SLS 3	Wind+ijs	-5°	1,00	1,00	0,0	0,26	0,71	0,0	
SLS 4	Wind	-20°	1,00	1,00	0,0	0,17	0,0	0,0	
SLS 6	Bouw en onderhoud	5°	1,00	1,00	0,0	0,17	0,0	0,0	
SLS 7	PB (EDS, geen wind)	10°	1,00	1,00	0,0	0,00	0,0	0,0	

Aantal windrichtingen 6
 Aantal belastingcombinaties ULS 68
 Aantal belastingcombinaties SPLS 222
 Aantal belastingcombinaties SLS 15
 Aantal knooplasten 5185

Project: RLL-TLB380
 Masttype: EA-3_co (bouw)
 Mast: 1025

Samenvattingstabellen geleiderbelastingen

In de onderstaande vier tabellen is weergegeven:

- De maximale geleiderbelasting in het globale assenstelsel, gesplitst in aandeel van back en ahead span
- De gecombineerde geleiderbelasting (Ba+Ah) in het globale assenstelsel met in het lokale assenstelsel de maximaal optredende trekkracht. Componenten Fx en Fy als absolute waarde
- De alledaagse (EDS) waarden van de gecombineerde geleiderbelastingen (Ba+Ah) met bijbehorende trekkrachten
- Controle op uplift, waar een negatieve waarde duidt op uplift

Maximale waarden voor back en ahead span

Geleider	Fx_ba [kN]	Fx_ah [kN]	Fy_ba [kN]	Fy_ah [kN]	Fz_ba [kN]	Fz_ah [kN]
bl1	-55,1	0,0	4,9	0,0	8,2	0,0
380ct1f1	-243,9	0,0	23,9	0,0	35,6	0,0
380ct1f2	-240,4	0,0	22,4	0,0	35,5	0,0
380ct1f3	-236,7	0,0	20,5	0,0	35,4	0,0
Post-isolato	0,0	0,0	0,0	0,0	0,0	
Post-isolato	0,0	0,0	0,0	0,0	0,0	
Post-isolato	0,0	0,0	0,0	0,0	0,0	
150ct2f1	-122,0	0,0	12,4	0,0	21,3	0,0
150ct2f2	-120,2	0,0	11,6	0,0	21,3	0,0
150ct2f3	-118,4	0,0	10,7	0,0	21,3	0,0

Min. Weight span (m)

Weight spar Combinatie1

Geleider	SLS 1a	SLS 4	SLS 7
bl1	240,5	248,5	240,5
380ct1f1	240,5	248,0	240,5
380ct1f2	240,5	247,9	240,5
380ct1f3	240,5	247,7	240,5
Post-isolator 1			
Post-isolator 2			
Post-isolator 3			
150ct2f1	240,5	248,0	240,5
150ct2f2	240,5	247,9	240,5
150ct2f3	240,5	247,7	240,5

Max. Weight span (m)

Weight spar Combinatie1

Geleider	ULS 1a	ULS 3
bl1	279,5	236,1
380ct1f1	259,6	241,4
380ct1f2	257,5	240,8
380ct1f3	255,0	240,2
Post-isolator 1		
Post-isolator 2		
Post-isolator 3		
150ct2f1	259,6	241,4
150ct2f2	257,5	240,8
150ct2f3	255,0	240,2

Omhullende weight span over alle combinaties (incl. 0,9 combinaties)

Voor alle geleiders

		Wind / Weight span verhouding
Max. weight span	279,5 m	0,699 -
Min. weight span	-6,0 m	-0,015 -

Project: RLL-TLB380
 Masttype: EA-3_co (bouw)
 Mast: 1025

Geleider	Maximale waarden back+ahead span			Maximale waarden trekkracht geleider	
	Fx [kN]	Fy [kN]	Fz [kN]	Ft_ba [kN]	Ft_ah [kN]
bl1	55,1	4,9	8,2	-55,1	0,0
380ct1f1	243,9	23,9	35,6	-243,9	0,0
380ct1f2	240,4	22,4	35,5	-240,4	0,0
380ct1f3	236,7	20,5	35,4	-236,7	0,0
Post-isolato	3,4	3,4	6,8	0,0	
Post-isolato	3,7	3,7	6,8	0,0	
Post-isolato	4,0	4,0	6,8	0,0	
150ct2f1	122,0	12,4	21,3	-122,0	0,0
150ct2f2	120,2	11,6	21,3	-120,2	0,0
150ct2f3	118,4	10,7	21,3	-118,4	0,0

Geleider	EDS-belastingen geleiders				
	Fx [kN]	Fy [kN]	Fz [kN]	Ft_ba [kN]	Ft_ah [kN]
bl1	0,0	0,0	2,4	-17,2	0,0
380ct1f1	0,0	0,0	20,5	-131,3	0,0
380ct1f2	0,0	0,0	20,5	-131,3	0,0
380ct1f3	0,0	0,0	20,5	-131,3	0,0
Post-isolato	0,0	0,0	5,0	0,0	
Post-isolato	0,0	0,0	5,0	0,0	
Post-isolato	0,0	0,0	5,0	0,0	
150ct2f1	0,0	0,0	10,8	-65,7	0,0
150ct2f2	0,0	0,0	10,8	-65,7	0,0
150ct2f3	0,0	0,0	10,8	-65,7	0,0

Combinatie: Geleider	Controle uplift SLS-wind	
	Fz_ba [kN]	Fz_ah [kN]
SLS 4 bl1	0,0	0,0
380ct1f1	0,0	0,0
380ct1f2	0,0	0,0
380ct1f3	0,0	0,0
Post-isolato	0,0	
Post-isolato	0,0	
Post-isolato	0,0	
150ct2f1	0,0	0,0
150ct2f2	0,0	0,0
150ct2f3	0,0	0,0

Project: RLL-TLB380
 Masttype: EA-3_co (bouw)
 Mast: 1025

ULS-fundatiebelasting combinatie 1 en 3 wind haaks op de lijn of bissectrice en EDS, vanuit geleiders

Combinatie	Combination	F_x	F_y	F_z	M_x	M_y	M_z
		[kN]	[kN]	[kN]	[kNm]	[kNm]	[kNm]
ULS 1a_90		-1045	117	141	2721	-37626	11106
ULS 1a_0,9_0		-694	0	81	-891	-24685	7307
ULS 1a_0,9_0,9_90		-976	117	44	3760	-35212	10376
ULS 3_0		-1045	0	186	-2036	-37488	11165
SLS 7		-608	0	111	-1219	-21646	6439

ULS-fundatiebelasting combinatie 1 en 3 wind haaks op de lijn of bissectrice en EDS, totaal geleiders en mast

Combinatie	F_x	F_y	F_z	M_x	M_y	M_z
	[kN]	[kN]	[kN]	[kNm]	[kNm]	[kNm]
ULS 1a_90	-1045	394	1370	9875	-37626	11106
ULS 1a_0,9_0,9_90	-976	394	966	10914	-35212	10376
SLS 7	-608	0	1136	-1219	-21646	6439

Fundatiebelastingen, selectie belastingcombinaties op basis grootste waarde

Combinatie	F_x	F_y	F_z	M_x	M_y	M_z
	[kN]	[kN]	[kN]	[kNm]	[kNm]	[kNm]
ULS 1a_0,9_0,9_75	-859	396	968	10934	-31721	9931
ULS 3_105	-1150	144	1417	2330	-41133	12052
ULS 3_90	-1137	145	1417	2384	-40901	12155
ULS 1a_0,9_105	-1091	396	989	10709	-38493	10785

Noot: grootste waarden kunnen in meerdere combinaties voorkomen, een combinatie is weergegeven.

Oplegreacties op fundering per randstijl

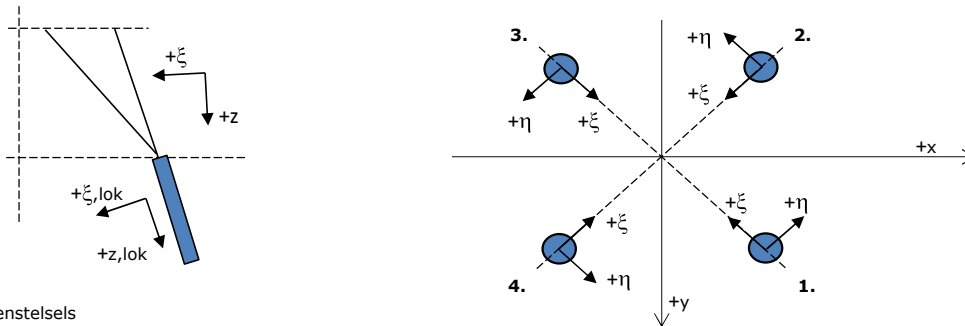

Assenstelsels

Maximale drukbelasting

Stijl	Combinatie	R_x	R_y	R_z	R_η	R_ξ	$R_{\xi,lok}$	$R_{z,lok}$
		[kN]	[kN]	[kN]	[kN]	[kN]	[kN]	[kN]
1	SPLS 1a_45 Ba All Cts	148	155	716	-5	-214	-22	741
2	SPLS 1a_0 Ba All Cts	130	-125	625	-4	-180	-12	647
3	ULS 3_135	-598	-165	2053	306	-540	12	2126
4	ULS 1a_105	-201	750	2429	388	-672	-20	2515

Maximale trekbelasting

Stijl	Combinatie	R_x	R_y	R_z	R_η	R_ξ	$R_{\xi,lok}$	$R_{z,lok}$
		[kN]	[kN]	[kN]	[kN]	[kN]	[kN]	[kN]
1	ULS 3_0,9_135	32	-533	-1405	400	354	-24	-1455
2	ULS 1a_0,9_105	-550	162	-1873	275	503	0	-1939
3	SPLS 1a_0,9_0,9_45 Ba All Cts	36	36	-166	0	51	7	-172
4	SPLS 1a_0,9_0 Ba All Cts	10	-13	-68	-2	16	-2	-70

Maximale torsiebelasting (positief)

Stijl	Combinatie	R_x	R_y	R_z	R_η	R_ξ	$R_{\xi,lok}$	$R_{z,lok}$
		[kN]	[kN]	[kN]	[kN]	[kN]	[kN]	[kN]
1	ULS 3_0,9_90	61	-540	-1365	425	339	-28	-1413
2	ULS 3_0,9_90	-522	89	-1646	306	432	-10	-1705
3	ULS 3_90	-599	-144	2014	321	-525	16	2086
4	ULS 3_90	-118	741	2220	441	-607	-11	2299

Maximale torsiebelasting (negatief)

Index	Combinatie	R_x	R_y	R_z	R_η	R_ξ	$R_{\xi,lok}$	$R_{z,lok}$
		[kN]	[kN]	[kN]	[kN]	[kN]	[kN]	[kN]
1	ULS 8 Ah	48	60	231	-8	-77	-14	239
2	ULS 8 Ah	72	-60	342	-8	-93	-1	354
3	SPLS 1a_0,9_0,9_45 Ba All Cts	36	36	-166	0	51	7	-172
4	SPLS 1a_0,9_0,9_0 Ba All Cts	9	-13	-67	-3	16	-2	-69

Project: RLL-TLB380
 Masttype: EA-3_co (bouw)
 Mast: 1025

Combinatie Ftrek+Fhor

Stijl	Combinatie	R _x [kN]	R _y [kN]	R _z [kN]	R _η [kN]	R _ξ [kN]	R _{ξ,lok} [kN]	R _{z,lok} [kN]
1	ULS 3_0,9_105	55	-540	-1377	421	343	-27	-1426
2	ULS 1a_0,9_105	-550	162	-1873	275	503	0	-1939
3	SPLS 1a_0,9_0,9_45 Ba All Cts	36	36	-166	0	51	7	-172
4	SPLS 1a_0,9_0,9_0 Ba All Cts	9	-13	-67	-3	16	-2	-69

Permanente belasting

Stijl	Combinatie	R _x [kN]	R _y [kN]	R _z [kN]	R _η [kN]	R _ξ [kN]	R _{ξ,lok} [kN]	R _{z,lok} [kN]
1	SLS 7	35	-274	-701	219	169	-19	-726
2	SLS 7	-220	-3	-596	158	154	-7	-617
3	SLS 7	-361	-116	1269	174	-337	4	1314
4	SLS 7	-62	393	1164	234	-322	-9	1206

Omhullenden ongeacht stijl

Belasting	Combinatie	R _x [kN]	R _y [kN]	R _z [kN]	R _η [kN]	R _ξ [kN]	R _{ξ,lok} [kN]	R _{z,lok} [kN]
Max. druk	ULS 1a_105	-201	750	2429	388	-672	-20	2515
Max. trek	ULS 1a_0,9_105	-550	162	-1873	275	503	0	-1939
Max. pos. torsie	ULS 3_90	-118	741	2220	441	-607	-11	2299
Max. neg. torsie	ULS 8 Ah	48	60	231	-8	-77	-14	239
Comb. trek+torsie	ULS 1a_0,9_105	-550	162	-1873	275	503	0	-1939

Maximale trekbelasting SLS

Stijl	Combinatie	R _x [kN]	R _y [kN]	R _z [kN]	R _η [kN]	R _ξ [kN]	R _{ξ,lok} [kN]	R _{z,lok} [kN]
1	SLS 3_135	36	-421	-1105	324	272	-25	-1144
2	SLS 1a_90	-399	88	-1290	220	344	-3	-1335
3	SLS 1a_45	-285	-19	863	188	-215	17	894
4	SLS 1a_0	1	323	842	229	-228	-2	872

Maximale drukbelasting SLS

Stijl	Combinatie	R _x [kN]	R _y [kN]	R _z [kN]	R _η [kN]	R _ξ [kN]	R _{ξ,lok} [kN]	R _{z,lok} [kN]
1	SLS 1a_45	140	-206	-295	245	47	-33	-305
2	SLS 1a_0	-154	-68	-274	157	60	-13	-284
3	SLS 3_135	-492	-137	1691	251	-445	9	1751
4	SLS 1a_90	-137	588	1860	319	-512	-13	1926

Project: RLL-TLB380
Masttype: EA-3_co (bouw)
Mast: 1025

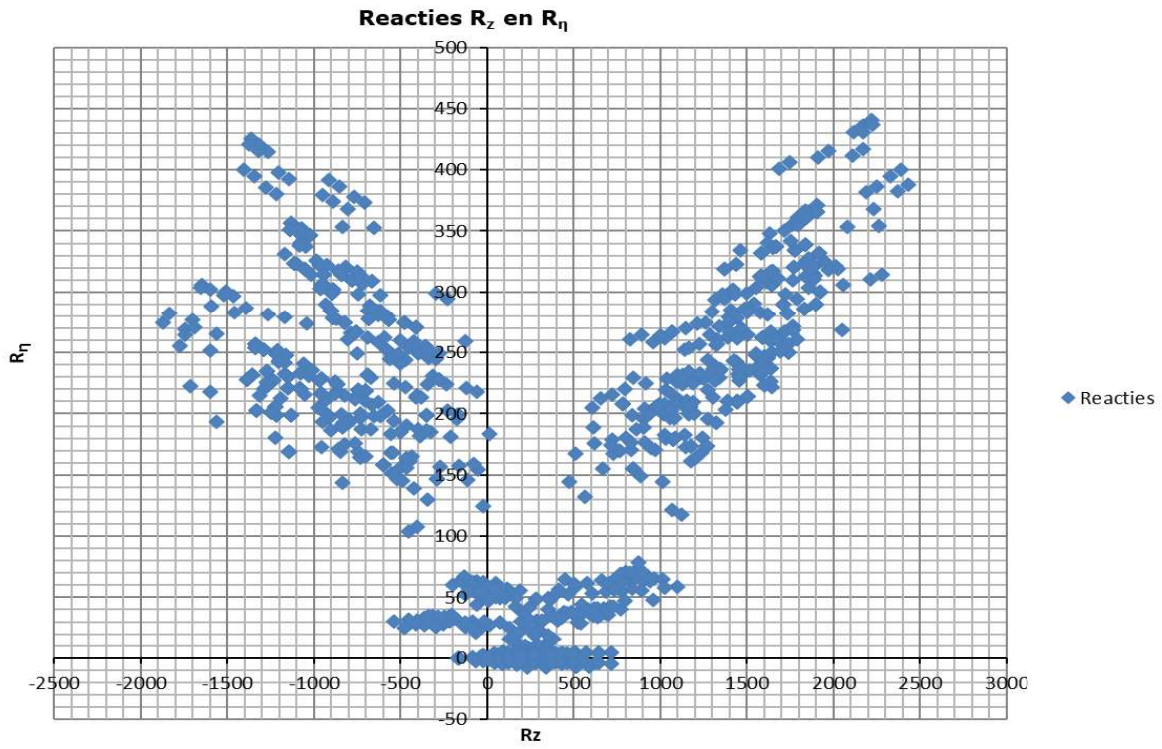

Project: RLL-TLB
 Tower: EA-3_co
 Number: 1025

Auteur: TBR
 Versie: v2.0

Geleiderbelastingen afloper

Algemeen

Benaming EA-3_co
 Masttype Hoekmast
 Aantal circuits 4
 Configuratie 4-circuit-dubbel verticaal
 Aantal bliksemgeleiders 2

Uitgangspunten

Norm NEN-EN50341-2-15:2019
 Gevolgklasse initieel CC2
 Betrouwbaarheidsniveau initieel Nieuwbouw
 Referentieperiode initieel 50 jaar
 Referentieperiode na aanpassing CC2
 Betrouwbaarheidsniveau na aanpassing n.v.t.
 Windgebied 50 jaar III
 Windsnelheid (m/s) 24,5 m/s
 Terreincategorie II
 Reductiefactor c_{dir} 1,00
 IJsg gebied fasegeleider B
 IJsg gebied bliksemgeleider A

Geleiders

Omschrijving	Spanning	Geleider Back	Bundel Ba	IJsg gebied	Toeslag gewicht	Toeslag diameter
Circuit 1	380 kV	AAAC-AL7 620	4	B	2 %	2 %
Circuit 2	380 kV	AAAC-AL7 620	4	B	2 %	2 %
Circuit 3	150 kV	AAAC-AL7 620	2	B	2 %	2 %
Circuit 4	150 kV	AAAC-AL7 620	2	B	2 %	2 %
Bliksemdraad 1		AACSR 241-AL3-39-A20SA	1	A	2 %	2 %
Bliksemdraad 2		OPGW AFL-226/38	1	A	2 %	2 %

Isolatoren (1)

Omschrijving	Ophanging	Gewicht [kN]	Lengte [m]	Windopp. [m ²]
Circuit 1	Afspanketting	3,00	4,50	1,10
Circuit 2	Afspanketting	3,00	4,50	1,10
Circuit 3	Afspanketting	2,00	3,50	0,80
Circuit 4	Afspanketting	2,00	3,50	0,80
Bliksemdraad 1	Afspanketting	0,10	0,20	0,10
Bliksemdraad 2	Afspanketting	0,10	0,20	0,10

1. *Eigenschappen gelden voor geheel van de isolatorset*

Ophanghoogte en positie in mast

Circuits	Nummer	Aanduiding	Ophanghoogte	Aangrijppunt
Circuit 1	10	380ct1f1	45,0 m	45,0 m
Circuit 1	11	380ct1f2	35,0 m	35,0 m
Circuit 1	12	380ct1f3	25,5 m	25,5 m
Circuit 2	40	380ct2f1	45,0 m	45,0 m
Circuit 2	41	380ct2f2	35,0 m	35,0 m
Circuit 2	42	380ct2f3	25,5 m	25,5 m
Circuit 3	20	150ct3f1	25,5 m	25,5 m
Circuit 3	21	150ct3f2	25,5 m	25,5 m
Circuit 3	22	150ct3f3	25,5 m	25,5 m
Circuit 4	30	150ct4f1	25,5 m	25,5 m
Circuit 4	31	150ct4f2	25,5 m	25,5 m
Circuit 4	32	150ct4f3	25,5 m	25,5 m
Bliksemdraad 1	1	bl1	50,1 m	50,1 m
Bliksemdraad 2	3	bl2	50,1 m	50,1 m

Project: RLL-TLB
 Tower: EA-3_co
 Number: 1025

Principe hoekmast met aflopers

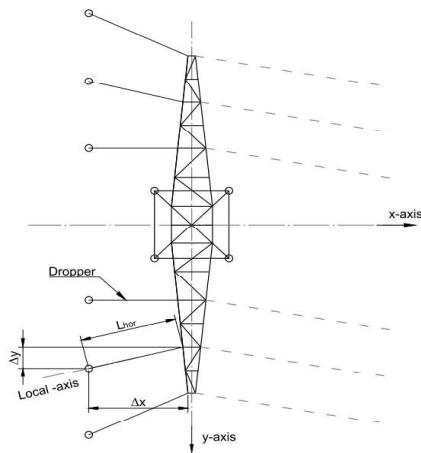

Top view tower

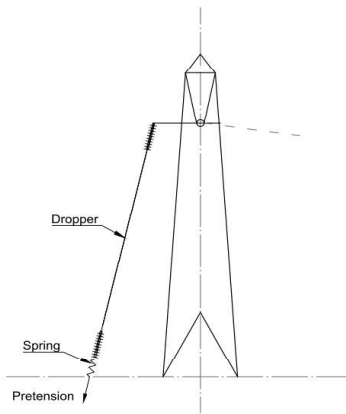

Side view tower

Hoogteafwijking mastbeeld naastgelegen masten en richtingsverandering t.o.v. Lijnrichting

Circuits	Nummer	Aanduiding	Hoogteverschil	Richtingsverandering		Lokaal Δx	Lengte overspanning
			Δh	Δy	Δx	Lhor	L
Circuit 1	10	380ct1f1	38,0 m	2,3	45,5	45,6	59,3 m
Circuit 1	11	380ct1f2	28,0 m	3,3	34,0	34,2	44,2 m
Circuit 1	12	380ct1f3	18,5 m	1,2	22,5	22,5	29,2 m
Circuit 2	40	380ct2f1	38,0 m	-2,3	45,5	45,6	59,3 m
Circuit 2	41	380ct2f2	28,0 m	-3,3	34,0	34,2	44,2 m
Circuit 2	42	380ct2f3	18,5 m	-1,2	22,5	22,5	29,2 m
Circuit 3	20	150ct3f1	25,5 m	-10,1	0,0	10,1	27,4 m
Circuit 3	21	150ct3f2	25,5 m	-6,4	2,5	6,9	26,4 m
Circuit 3	22	150ct3f3	25,5 m	-6,4	-3,7	-7,4	26,5 m
Circuit 4	30	150ct4f1	25,5 m	10,1	0,0	10,1	27,4 m
Circuit 4	31	150ct4f2	25,5 m	6,4	2,5	6,9	26,4 m
Circuit 4	32	150ct4f3	25,5 m	6,4	-3,7	-7,4	26,5 m
Bliksemdraad 1	1	bl1	35,6 m	6,7	45,5	46,0	58,2 m
Bliksemdraad 2	3	bl2	35,6 m	-6,7	45,5	46,0	58,2 m

Voorspanning en veerstijfheid

Circuits	Nummer	Aanduiding	Voorspanning	Veerstijfheid	Effectieve rekstijfheid
			F_{pr}	k	EA_{ict}
Circuit 1	10	380ct1f1	11,8 kN	10000 kN/m	94010 kN/m
Circuit 1	11	380ct1f2	7,3 kN	10000 kN/m	80308 kN/m
Circuit 1	12	380ct1f3	4,4 kN	10000 kN/m	56449 kN/m
Circuit 2	40	380ct2f1	11,8 kN	10000 kN/m	94010 kN/m
Circuit 2	41	380ct2f2	7,3 kN	10000 kN/m	80308 kN/m
Circuit 2	42	380ct2f3	4,4 kN	10000 kN/m	56449 kN/m
Circuit 3	20	150ct3f1	5,0 kN	1000 kN/m	14613 kN/m
Circuit 3	21	150ct3f2	5,0 kN	1000 kN/m	14613 kN/m
Circuit 3	22	150ct3f3	5,0 kN	1000 kN/m	14613 kN/m
Circuit 4	30	150ct4f1	5,0 kN	1000 kN/m	14613 kN/m
Circuit 4	31	150ct4f2	5,0 kN	1000 kN/m	14613 kN/m
Circuit 4	32	150ct4f3	5,0 kN	1000 kN/m	14613 kN/m
Bliksemdraad 1	1	bl1	1,4 kN	5000 kN/m	17730 kN/m
Bliksemdraad 2	3	bl2	1,4 kN	5000 kN/m	17155 kN/m

De effectieve rekstijfheid is bepaald met de invloed van de veerstijfheid
 Deze is berekend door de optelling van de reciproke waarden van de veerstijfheid van geleider en veer.

Project: RLL-TLB
 Tower: EA-3_co
 Number: 1025

Lijn- en mastgegevens

Deze invoer is opgenomen voor beschouwde windrichtingen en komt overeen met invoer geleiderbelastingen voor de mast

Lijnhoek	β	180 °
Rotatie mast t.o.v. bissectrice	θ	0 °
Hoogte onderkant mast t.o.v. maaiveld		0,5 m
Beschouwde windrichtingen	α_1	0 °
Windrichtingen volgens:	α_2	45 °
Geleiderbelastingen	α_3	90 °
	α_4	135 °
	α_5	75 °
	α_6	105 °

Windrichtingen gelden t.o.v. hoofdrichting mastconstructie, niet t.o.v. bissectrice.

Windrichtingen en positieve richtingen belastingen

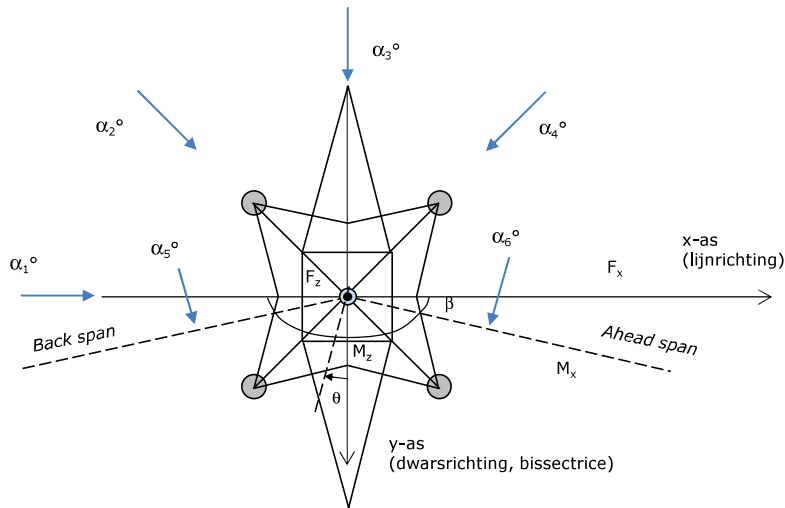

<u>Beschouwd aantal windrichtingen</u>	
1a	6
3	6
4	1
6	6
Overig	6

Project: RLL-TLB
 Tower: EA-3_co
 Number: 1025

Geleiderafval

		SPLS - torsie		SPLS - Enkelzijdige trek		5a - geleiderbreuk	
		Aanw.	Afw.	Aanw.	Afw.	Aanw.	Afw.
Circuit 1	380ct1f1	1	0	1	0	1	0
Circuit 1	380ct1f2	1	0	1	0	1	0
Circuit 1	380ct1f3	1	0	1	0	1	0
Circuit 2	380ct2f1	0	1	1	0	1	0
Circuit 2	380ct2f2	0	1	1	0	1	0
Circuit 2	380ct2f3	0	1	1	0	1	0
Circuit 3	150ct3f1	1	0	1	0	1	0
Circuit 3	150ct3f2	1	0	1	0	1	0
Circuit 3	150ct3f3	1	0	1	0	1	0
Circuit 4	150ct4f1	0	1	1	0	1	0
Circuit 4	150ct4f2	0	1	1	0	1	0
Circuit 4	150ct4f3	0	1	1	0	1	0
Bliksemdraad 1	b1	1	0	1	0	1	0
Bliksemdraad 2	b2	0	1	1	0	1	0

Belastingssituaties SPLS

Beschouwde situaties SPLS: 1 t/m 6, alle mogelijke situaties.
 Geleiderbelastingen naar volgende mast geen onderdeel van deze berekening.

Principe belastingssituaties:

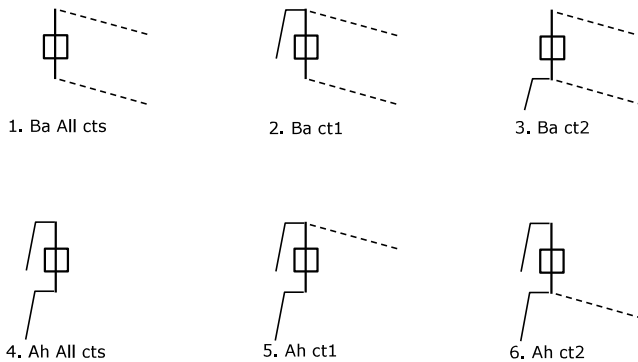

Belastingssituaties 5a. Geleiderbreuk

Beschouwde situaties geleiderbreuk 5a: 1 en 2, alle mogelijke situaties.

Principe belastingssituaties:

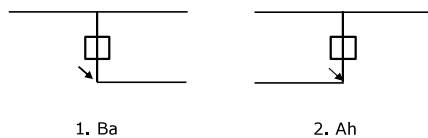

Project: RLL-TLB
 Tower: EA-3_co
 Number: 1025

Belastingsituaties 6. Bouw- en onderhoud

Onder 6a wordt de belasting door aanwezigheid lijnwagen of lijnfiets in combinatie met puntlast op traverse in rekening gebracht. Combinatie 6b bevat geen belastingen in geleider of op traverse. Deze combinatie met 20% wind is geschikt voor controle stijppunt in combinatie met kortsluitbelastingen.

	Fase	Bliksem
Lijnwagen (nvt.)	0,0 kN	0,0 kN
Puntlast op traverse	1,0 kN	1,0 kN

Belastingsituaties 8. Kortsluiting

Principe belastingssituaties:

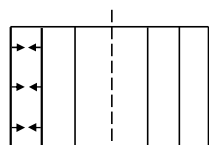

1. 10-11

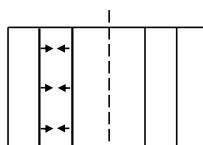

2. 11-12



3. 10-12

Kortsluitkrachten

(Zie separate berekening)

Geleider	$w_{z,G}$	Kortsluitkra	F_x	F_y	F_z
	[N/m]	[kN]	[kN]	[kN]	[kN]
10	380ct1f1	80,1	61,4	3,1	51,3
11	380ct1f2	77,0	59,3	5,8	48,8
12	380ct1f3	44,8	34,6	1,8	28,4
40	380ct2f1	80,1	61,4	-3,1	51,3
41	380ct2f2	77,0	59,3	-5,8	48,8
42	380ct2f3	44,8	34,6	-1,8	28,4
20	150ct3f1	24,0	0,0	-8,8	22,3
21	150ct3f2	24,3	2,3	-5,9	23,5
22	150ct3f3	24,3	-3,4	-5,9	23,3
30	150ct4f1	24,0	0,0	8,8	22,3
31	150ct4f2	24,3	2,3	5,9	23,5
32	150ct4f3	24,3	-3,4	5,9	23,3
1	bl1				
3	bl2				

Belastingcombinaties kortsluiting

Belastingcombinatie

ULS 8 Kortsluiting 10-11
 ULS 8 Kortsluiting 10-12
 ULS 8 Kortsluiting 11-12
 ULS 8 Kortsluiting 40-41
 ULS 8 Kortsluiting 40-42
 ULS 8 Kortsluiting 41-42
 ULS 8 Kortsluiting 20-21
 ULS 8 Kortsluiting 20-22
 ULS 8 Kortsluiting 21-22
 ULS 8 Kortsluiting 30-31
 ULS 8 Kortsluiting 30-32
 ULS 8 Kortsluiting 31-32

Project: RLL-TLB
 Tower: EA-3_co
 Number: 1025

Tussenresultaten geleiderbelastingen

Geleiders

Circuit	Geleider	Diameter [mm]	A [mm ²]	G [N/m]	E [N/mm ²]	αT [-]
Circuit 1	AAAC-AL7 620	32,4	621,0	17,71	56000	2,30E-05
Circuit 2	AAAC-AL7 620	32,4	621,0	17,71	56000	2,30E-05
Circuit 3	AAAC-AL7 620	32,4	621,0	17,71	56000	2,30E-05
Circuit 4	AAAC-AL7 620	32,4	621,0	17,71	56000	2,30E-05
Bliksemdraad 1	AACSR 241-AL3-39-A20SA	21,8	281,0	9,38	70165	1,97E-05
Bliksemdraad 2	OPGW AFL-226/38	21,7	264,0	9,13	72000	1,98E-05

Verticale belasting

Circuit	Bundel [-]	Toeslag [%]	$W_{z,G}$ [N/m]	IJsg gebied	Formule	$W_{z,IJS}$ [N/m]	$W_{z,IJS,bundel}$ [N/m]
Circuit 1	4	2	72,3	B	4+0,2d	10,5	41,9
Circuit 2	4	2	72,3	B	4+0,2d	10,5	41,9
Circuit 3	2	2	36,1	B	4+0,2d	10,5	21,0
Circuit 4	2	2	36,1	B	4+0,2d	10,5	21,0
Bliksemdraad 1	1	2	9,6	A	15+0,4d	23,7	23,7
Bliksemdraad 2	1	2	9,3	A	15+0,4d	23,7	23,7

Schema voor berekenen horizontale en verticale belasting

Horizontale belasting wordt bepaald voor de wind tegen de geleider en isolatoren boven en onder.

De horizontale component als gevolg van de scheefstand van de afloper wordt per belastingscombinatie apart bepaald

De verticale krachten gelden alleen voor de EDS-conditie zonder externe belastingen en temperatuursverandering

De berekeningen zijn weergegeven op het volgende blad.

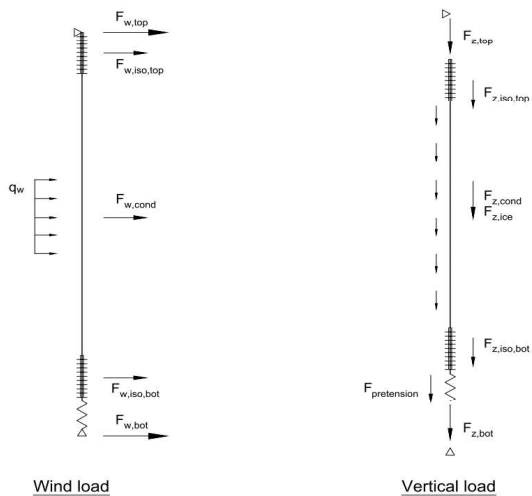

Project: RLL-TLB
 Tower: EA-3_co
 Number: 1025

Geleider	G _{isolator} [kN]	Lengte [m]	Boven			Onder				
			Windopp. [m ²]	Vormfactor [-]	Windhoogte [m]	Stuwdruk [kN/m ²]	F _{h,iso} [kN]	Windhoogte [m]	Stuwdruk [kN/m ²]	F _{h,iso} [kN]
380ct1f1	3,00	4,5	1,1	1,2	43,25	1,09	1,44	9,75	0,70	0,92
380ct1f2	3,00	4,5	1,1	1,2	33,25	1,02	1,34	9,75	0,70	0,92
380ct1f3	3,00	4,5	1,1	1,2	23,75	0,92	1,22	9,75	0,70	0,92
380ct2f1	3,00	4,5	1,1	1,2	43,25	1,09	1,44	9,75	0,70	0,92
380ct2f2	3,00	4,5	1,1	1,2	33,25	1,02	1,34	9,75	0,70	0,92
380ct2f3	3,00	4,5	1,1	1,2	23,75	0,92	1,22	9,75	0,70	0,92
150ct3f1	2,00	3,5	0,8	1,2	24,25	0,93	0,89	2,25	0,49	0,47
150ct3f2	2,00	3,5	0,8	1,2	24,25	0,93	0,89	2,25	0,49	0,47
150ct3f3	2,00	3,5	0,8	1,2	24,25	0,93	0,89	2,25	0,49	0,47
150ct4f1	2,00	3,5	0,8	1,2	24,25	0,93	0,89	2,25	0,49	0,47
150ct4f2	2,00	3,5	0,8	1,2	24,25	0,93	0,89	2,25	0,49	0,47
150ct4f3	2,00	3,5	0,8	1,2	24,25	0,93	0,89	2,25	0,49	0,47
bl1	0,10	0,2	0,1	1,2	50,50	1,14	0,14	15,10	0,80	0,10
bl2	0,10	0,2	0,1	1,2	50,50	1,14	0,14	15,10	0,80	0,10

Geleider	wind hoogte		G _c [-]	C _c [-]	d _{toeslag} [mm]	w _y [N/m]	D _{ijs,toeslag} [mm]	w _{y,ijs} [N/m]	F _{w,geleider} [kN]	F _{w,boven} [kN]	F _{w,onder} [kN]
	[m]	Stuwdruk [kN/m ²]									
380ct1f1	26,5	0,95	0,86	1,02	33,05	109,9	51,3	201,3	1,59	3,0	2,5
380ct1f2	21,5	0,90	0,84	1,04	33,05	103,4	51,3	186,0	0,98	2,3	1,9
380ct1f3	16,8	0,83	0,82	1,06	33,05	95,7	51,3	168,4	0,45	1,7	1,4
380ct2f1	26,5	0,95	0,86	1,02	33,05	109,9	51,3	201,3	1,59	3,0	2,5
380ct2f2	21,5	0,90	0,84	1,04	33,05	103,4	51,3	186,0	0,98	2,3	1,9
380ct2f3	16,8	0,83	0,82	1,06	33,05	95,7	51,3	168,4	0,45	1,7	1,4
150ct3f1	13,3	0,77	0,80	1,08	33,05	44,3	51,3	76,3	0,41	1,3	0,9
150ct3f2	13,3	0,77	0,80	1,08	33,05	44,3	51,3	76,3	0,41	1,3	0,9
150ct3f3	13,3	0,77	0,80	1,08	33,05	44,3	51,3	76,3	0,41	1,3	0,9
150ct4f1	13,3	0,77	0,80	1,08	33,05	44,3	51,3	76,3	0,41	1,3	0,9
150ct4f2	13,3	0,77	0,80	1,08	33,05	44,3	51,3	76,3	0,41	1,3	0,9
150ct4f3	13,3	0,77	0,80	1,08	33,05	44,3	51,3	76,3	0,41	1,3	0,9
bl1	32,8	1,01	0,87	1,20	22,24	23,5	63,1	66,8	0,41	0,6	0,5
bl2	32,8	1,01	0,87	1,20	22,13	23,4	63,0	66,8	0,41	0,5	0,5

Verticale belasting

Formules: $F_{z,top} = F_{z,iso,top} + F_{z,cond} + F_{z,iso,bot} + F_{pr}$ $L_{geleider} = \Delta h - 2L_{iso}$
 $F_{t,mid} = F_{z,cond}/2 + F_{z,iso,bot} + F_{pr}$ $F_{z,cond} = L_{cond} \times w_z$
 $F_{z,bot} = -F_{pr}$

Geleider	w _{z,G} [N/m]	w _{z,ijs} [N/m]	L _{geleider} [m]	F _{z,iso} [kN]	F _{z,gel} [kN]	F _{z,ijs} [kN]	Pretension [kN]	F _{z,boven} [kN]	F _{t,mid} [kN]	F _{z,onder} [kN]
380ct1f1	72,3	41,9	29,0	3,0	2,1	1,2	11,8	19,9	15,9	-11,8
380ct1f2	72,3	41,9	19,0	3,0	1,4	0,8	7,3	14,7	11,0	-7,3
380ct1f3	72,3	41,9	9,5	3,0	0,7	0,4	4,4	11,1	7,7	-4,4
380ct2f1	72,3	41,9	29,0	3,0	2,1	1,2	11,8	19,9	15,9	-11,8
380ct2f2	72,3	41,9	19,0	3,0	1,4	0,8	7,3	14,7	11,0	-7,3
380ct2f3	72,3	41,9	9,5	3,0	0,7	0,4	4,4	11,1	7,7	-4,4
150ct3f1	36,1	21,0	18,5	2,0	0,7	0,4	5,0	9,7	7,3	-5,0
150ct3f2	36,1	21,0	18,5	2,0	0,7	0,4	5,0	9,7	7,3	-5,0
150ct3f3	36,1	21,0	18,5	2,0	0,7	0,4	5,0	9,7	7,3	-5,0
150ct4f1	36,1	21,0	18,5	2,0	0,7	0,4	5,0	9,7	7,3	-5,0
150ct4f2	36,1	21,0	18,5	2,0	0,7	0,4	5,0	9,7	7,3	-5,0
150ct4f3	36,1	21,0	18,5	2,0	0,7	0,4	5,0	9,7	7,3	-5,0
bl1	9,6	23,7	35,2	0,1	0,3	0,8	1,4	1,9	1,7	-1,4
bl2	9,3	23,7	35,2	0,1	0,3	0,8	1,4	1,9	1,7	-1,4

Project: RLL-TLB
 Masttype: EA-3_co
 Mast: 1025

Auteur: TBR
 Versie: v2.0

Geleiderbelastingen

Uitgangspunten

Betrouwbaarheidsniveau Nieuwbouw CC2
 Referentieperiode 50 jaar

ULS (bezwijksterkte)		NEN-EN50341-2-15:2019			γ_Q			γ_A
Belastingsgeval	omschrijving	Temp °C	γ_G $G_{k,mast}$	γ_G $G_{k,geleider}$	Q_{pk}	Q_{wk}	Q_{ik}	A_k
ULS 1a	Wind	10°	1,20	1,20	0,00	1,50	0,00	0,0
ULS 1a_0,9	Wind 0,9Gk alleen mast	10°	0,90	1,20	0,00	1,50	0,00	0,0
ULS 1a_0,9_0,9	Wind 0,9Gk ook geleider	10°	0,90	0,90	0,00	1,50	0,00	0,0
ULS 3	Wind+ijs	-5°	1,20	1,20	0,00	0,45	1,50	0,0
ULS 3_0,9	Wind+ijs 0,9	-5°	0,90	1,20	0,00	0,45	1,50	0,0
ULS 4	Koude+wind	-20°	1,20	1,20	0,00	0,30	0,00	0,0
ULS 4_0,9	Koude+wind 0,9	-20°	0,90	1,20	0,00	0,30	0,00	0,0
ULS 5a	Torsiebelastingen	10°	1,00	1,00	1,00	0,00	0,00	1,0
ULS 5b	Longitudinale belastingen	10°	1,00	1,00	0,00	0,00	0,00	1,0
ULS 6	Bouw en onderhoud	5°	1,20	1,20	1,50	0,30	0,00	0,0
ULS 6_0,9	Bouw en onderhoud	5°	1,20	1,20	0,00	0,30	0,00	0,0
ULS 7	Permanent	10°	1,35	1,35	0,00	0,00	0,00	0,0
ULS 8	Special	10°	1,00	1,00	0,00	0,00	0,00	1,0
SPLS (Bezwijksterkte, enkel voor hoekmasten: afwezigheid geleiders)			γ_G		γ_Q			γ_A
			G_k	G_k	Q_{pk}	Q_{wk}	Q_{ik}	A_k
SPLS 1a	Wind	10°	1,20	1,20	0,0	0,78	0,00	0,0
SPLS 1a_0,9	Wind 0,9	10°	0,90	1,20	0,0	0,78	0,00	0,0
SPLS 1a_0,9_0,9	Wind 0,9	10°	0,90	0,90	0,0	0,78	0,00	0,0
SPLS 3	Wind+ijs	-5°	1,20	1,20	0,0	0,36	0,34	0,0
SPLS 3_0,9	Wind+ijs 0,9	-5°	0,90	1,20	0,0	0,36	0,34	0,0
SPLS 4	Koude+wind	-20°	1,20	1,20	0,0	0,24	0,00	0,0
SPLS 4_0,9	Koude+wind 0,9	-20°	0,90	1,20	0,0	0,24	0,00	0,0
SPLS 6	Bouw en onderhoud	5°	1,20	1,20	1,2	0,24	0,0	0,0
SPLS 6_0,9	Bouw en onderhoud	5°	1,20	1,20	0,0	0,24	0,0	0,0
SLS (controle van de vervormingen, vermoeiing, EDS)			G_k		Q_k			A_k
					Q_{pk}	Q_{wk}	Q_{ik}	A_k
SLS 1a	Wind	10°	1,00	1,00	0,0	1,00	0,0	0,0
SLS 3	Wind+ijs	-5°	1,00	1,00	0,0	0,30	1,00	0,0
SLS 4	Wind	-20°	1,00	1,00	0,0	0,20	0,0	0,0
SLS 6	Bouw en onderhoud	5°	1,00	1,00	0,0	0,20	0,0	0,0
SLS 7	PB (EDS, geen wind)	10°	1,00	1,00	0,0	0,00	0,0	0,0

Aantal windrichtingen 6
 Aantal belastingcombinaties ULS 71
 Aantal belastingcombinaties SPLS 222
 Aantal belastingcombinaties SLS 15
 Aantal knooplasten 10472

Schematisation

De trekkracht in de afloper wordt bepaald met de toestandsvergelijking voor een gekromde kabel. In de rekstijfheid van de kabel is de invloed van de veer verdisconteerd.

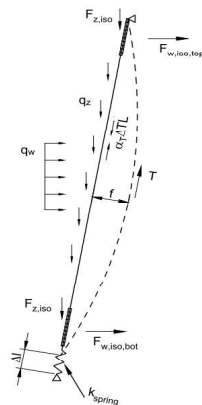

Project: RLL-TLB
 Masttype: EA-3_co
 Mast: 1025

Tabellen met geleiderbelastingen

In de onderstaande drie tabellen is weergegeven:

- De trekkracht per belastingcombinatie en de bijbehorende zeeg en veerverlenging
- De geleiderbelastingen in het lokale assenstelsel voor het onderste bevestigingspunt
- De maximale waarden voor de reacties onder en boven in het globale assenstelsel
- Kortsluitbelastingen zijn niet weergegeven!

Trekkracht, zeeg en veerverlenging

Geleider	Combinatie	Zeeg [m]	Veer- verlenging [m]	Totale veerverlenging [m]	Trek- kracht initieel [kN]	Trek- kracht [kN]
380ct1f1	SLS 1a	2,39	0,002	0,003	15,9	34,7
	SLS 3	2,28	0,002	0,003	16,5	32,0
	SLS 4	2,13	0,000	0,002	15,9	17,8
	SLS 6	2,30	0,000	0,002	15,9	16,5
	SLS 7	2,33	0,000	0,002	15,9	15,9
	ULS 1a	2,42	0,003	0,005	20,0	46,5
	ULS 3	2,31	0,003	0,004	21,1	41,8
	ULS 4	2,14	0,000	0,002	20,0	20,6
	ULS 6b	2,32	0,001	0,002	20,0	23,3
	380ct1f2	SLS 1a	2,44	0,001	0,002	11,0
SLS 3		2,39	0,001	0,002	11,4	19,3
SLS 4		2,32	0,000	0,001	11,0	11,5
SLS 6		2,41	0,000	0,001	11,0	11,1
SLS 7		2,42	0,000	0,001	11,0	11,0
ULS 1a		2,46	0,002	0,003	14,1	28,2
ULS 3		2,40	0,001	0,002	14,8	24,6
ULS 4		2,32	0,000	0,001	14,1	12,9
ULS 6b		2,41	0,000	0,001	14,1	14,9
380ct1f3		SLS 1a	2,45	0,001	0,001	7,7
	SLS 3	2,43	0,000	0,001	7,9	11,4
	SLS 4	2,40	0,000	0,001	7,7	7,9
	SLS 6	2,44	0,000	0,001	7,7	7,8
	SLS 7	2,45	0,000	0,001	7,7	7,7
	ULS 1a	2,46	0,001	0,002	10,1	16,5
	ULS 3	2,43	0,001	0,001	10,4	13,8
	ULS 4	2,40	0,000	0,001	10,1	8,5
	ULS 6b	2,44	0,000	0,001	10,1	9,7
bl1	SLS 1a	2,00	0,001	0,001	1,7	6,1
	SLS 3	1,96	0,001	0,002	2,1	9,0
	SLS 4	1,72	0,000	0,000	1,7	2,1
	SLS 6	1,89	0,000	0,000	1,7	1,9
	SLS 7	1,92	0,000	0,000	1,7	1,7
	ULS 1a	2,04	0,001	0,002	2,1	8,6
	ULS 3	2,02	0,002	0,003	2,8	12,6
	ULS 4	1,73	0,000	0,001	2,1	2,6
	ULS 6b	1,92	0,000	0,001	2,1	3,2
150ct3f1	SLS 1a	0,54	0,008	0,015	7,3	15,3
	SLS 3	0,42	0,007	0,014	7,5	14,2
	SLS 4	0,23	0,006	0,013	7,3	13,0
	SLS 6	0,36	0,001	0,008	7,3	8,4
	SLS 7	0,37	0,000	0,007	7,3	7,3
	ULS 1a	0,60	0,012	0,019	9,4	19,0
	ULS 3	0,47	0,009	0,017	9,7	16,7
	ULS 4	0,26	0,006	0,014	9,4	13,6
	ULS 6b	0,42	0,003	0,011	9,4	10,8
150ct3f2	SLS 1a	0,46	0,009	0,016	7,3	16,0
	SLS 3	0,33	0,008	0,015	7,5	15,1
	SLS 4	0,18	0,009	0,016	7,3	15,9
	SLS 6	0,28	0,003	0,010	7,3	10,1
	SLS 7	0,24	0,000	0,007	7,3	7,3
	ULS 1a	0,53	0,012	0,020	9,4	19,6
	ULS 3	0,39	0,010	0,017	9,7	17,4
	ULS 4	0,21	0,009	0,017	9,4	16,6
	ULS 6b	0,32	0,004	0,011	9,4	11,4
150ct3f3	SLS 1a	0,47	0,009	0,016	7,3	15,9
	SLS 3	0,34	0,008	0,015	7,5	15,0
	SLS 4	0,19	0,008	0,016	7,3	15,6
	SLS 6	0,30	0,003	0,010	7,3	10,0
	SLS 7	0,26	0,000	0,007	7,3	7,3
	ULS 1a	0,54	0,012	0,019	9,4	19,5
	ULS 3	0,40	0,010	0,017	9,7	17,3
	ULS 4	0,23	0,009	0,016	9,4	16,3
	ULS 6b	0,33	0,004	0,011	9,4	11,3

Controle iteratieproces

Geleider	Iteratie
380ct1f1	OK
380ct1f2	OK
380ct1f3	OK
bl1	OK
bl2	OK
380ct2f1	OK
380ct2f2	OK
380ct2f3	OK
150ct3f1	OK
150ct3f2	OK
150ct3f3	OK
150ct4f1	OK
150ct4f2	OK
150ct4f3	OK
Post 1	(leeg)
Post 2	(leeg)
Post 3	(leeg)
Post 4	(leeg)
Post 5	(leeg)
Post 6	(leeg)

Project: RLL-TLB
 Masttype: EA-3_co
 Mast: 1025

Belastingen in lokale richting geleider

De belastingen op het onderste bevestigingspunt voor het dimensioneren van de ondersteuningsconstructie

De richting van de laterale kracht wordt bepaald door de windrichting en kan in alle richtingen aangrijpen.

De resulterende horizontale kracht kan worden afgeleid uit de vectoriële optelling van de kracht in x-richting en laterale kracht.

Combinatie1	F _{x,lok,bot} [kN]	F _{lat,bot} [kN]	F _{z_bot} [kN]
SLS 1a	41,6	2,5	-30,7
SLS 3	38,4	1,2	-27,4
SLS 4	21,4	0,5	-13,8
SLS 6	19,8	0,5	-12,5
SLS 7	19,0	0,0	-11,8
ULS 1a	55,7	3,8	-41,6
ULS 3	50,1	1,7	-36,0
ULS 4	24,7	0,8	-15,7
ULS 6b	27,9	0,8	-18,4
SLS 1a	26,1	1,9	-17,7
SLS 3	23,5	0,8	-15,2
SLS 4	14,1	0,4	-7,9
SLS 6	13,6	0,4	-7,4
SLS 7	13,4	0,0	-7,3
ULS 1a	34,4	2,9	-23,8
ULS 3	30,0	1,2	-19,6
ULS 4	15,7	0,6	-8,5
ULS 6b	18,2	0,6	-10,5
SLS 1a	15,9	1,4	-9,7
SLS 3	13,9	0,5	-7,9
SLS 4	9,6	0,3	-4,6
SLS 6	9,5	0,3	-4,4
SLS 7	9,4	0,0	-4,4
ULS 1a	20,0	2,1	-12,4
ULS 3	16,8	0,8	-9,5
ULS 4	10,3	0,4	-4,5
ULS 6b	11,8	0,4	-5,6
SLS 1a	7,9	0,5	-5,8
SLS 3	11,6	0,4	-8,3
SLS 4	2,7	0,1	-1,8
SLS 6	2,4	0,1	-1,6
SLS 7	2,2	0,0	-1,4
ULS 1a	11,1	0,8	-8,3
ULS 3	16,3	0,6	-11,7
ULS 4	3,4	0,2	-2,3
ULS 6b	4,1	0,2	-2,9
SLS 1a	6,1	1,0	-13,0
SLS 3	5,6	0,4	-11,7
SLS 4	5,1	0,2	-10,6
SLS 6	3,3	0,2	-6,1
SLS 7	2,9	0,0	-5,0
ULS 1a	7,5	1,5	-16,2
ULS 3	6,6	0,6	-13,6
ULS 4	5,4	0,3	-10,8
ULS 6b	4,3	0,3	-8,0
SLS 1a	4,3	1,0	-13,6
SLS 3	4,1	0,4	-12,6
SLS 4	4,3	0,2	-13,6
SLS 6	2,7	0,2	-7,8
SLS 7	2,0	0,0	-5,0
ULS 1a	5,3	1,5	-16,8
ULS 3	4,7	0,6	-14,3
ULS 4	4,5	0,3	-13,8
ULS 6b	3,1	0,3	-8,6
SLS 1a	4,6	1,0	-13,5
SLS 3	4,3	0,4	-12,4
SLS 4	4,5	0,2	-13,2
SLS 6	2,9	0,2	-7,7
SLS 7	2,1	0,0	-5,0
ULS 1a	5,6	1,5	-16,7
ULS 3	5,0	0,6	-14,2
ULS 4	4,7	0,3	-13,5
ULS 6b	3,3	0,3	-8,5

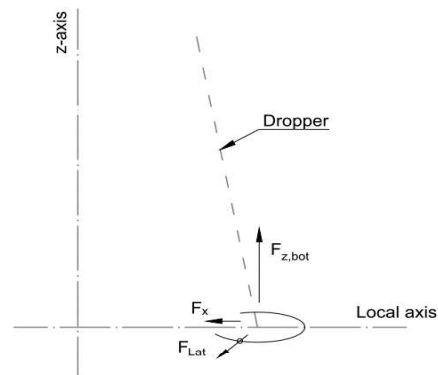

Project: RLL-TLB
 Masttype: EA-3_co
 Mast: 1025

Maximale waarden in globale assenstelsel

De maximale waarden van de verticale kracht en de resulterende horizontale kracht per belastingcombinatie
 Zowel voor het bovenste als het onderste bevestigingspunt

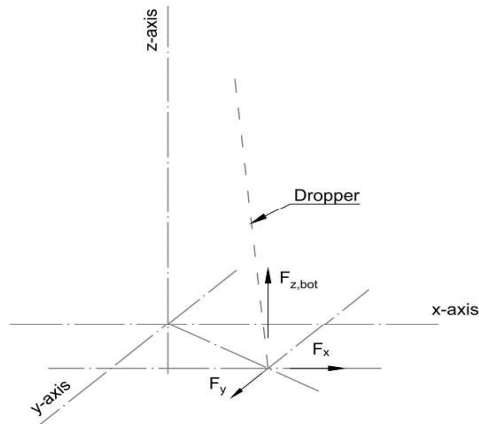

Geleider	Combinatie	Fx_top [kN]	Fy_top [kN]	Fz_top [kN]	Fx_bot [kN]	Fy_bot [kN]	Fz_bot [kN]
380ct1f1	SLS 1a	37,5	5,1	38,8	-45,3	-0,5	-30,7
	SLS 3	35,0	3,1	36,7	-41,5	-1,0	-27,4
	SLS 4	19,7	1,7	21,9	-22,9	-0,6	-13,8
	SLS 6	18,2	1,6	20,6	-21,4	-0,5	-12,5
	SLS 7	17,4	0,9	19,9	-20,6	-1,0	-11,8
	ULS 1a	50,0	7,5	51,3	-60,6	-1,1	-41,6
	ULS 3	45,5	4,3	47,6	-54,3	-1,2	-36,0
	ULS 4	22,7	2,2	25,4	-26,5	-0,4	-15,7
	ULS 6b	25,2	2,2	28,1	-30,3	-0,9	-18,4
	ULS 7	21,1	1,1	24,9	-25,3	-1,3	-14,0
380ct1f2	SLS 1a	22,4	4,8	25,1	-29,2	-1,0	-17,7
	SLS 3	20,6	3,0	23,4	-26,2	-1,7	-15,2
	SLS 4	12,5	1,8	15,2	-15,5	-1,0	-7,9
	SLS 6	12,0	1,8	14,8	-15,0	-1,0	-7,4
	SLS 7	11,8	1,1	14,7	-14,9	-1,4	-7,3
	ULS 1a	29,3	6,9	32,6	-38,5	-1,0	-23,8
	ULS 3	26,0	4,0	29,6	-33,4	-2,0	-19,6
	ULS 4	13,8	2,2	17,3	-17,3	-1,0	-8,5
	ULS 6b	15,7	2,3	19,3	-20,3	-1,4	-10,5
	ULS 7	13,6	1,3	17,9	-17,5	-1,7	-8,0
380ct1f3	SLS 1a	12,5	3,0	16,4	-18,8	-0,2	-9,7
	SLS 3	11,3	1,5	15,0	-16,4	-0,5	-7,9
	SLS 4	8,0	0,9	11,2	-11,3	-0,2	-4,6
	SLS 6	7,8	0,9	11,1	-11,1	-0,2	-4,4
	SLS 7	7,7	0,4	11,1	-11,0	-0,6	-4,4
	ULS 1a	15,5	4,3	20,5	-23,8	-0,2	-12,4
	ULS 3	13,4	2,0	18,1	-19,8	-0,5	-9,5
	ULS 4	8,3	1,2	12,5	-12,1	-0,1	-4,5
	ULS 6b	9,3	1,2	13,7	-13,9	-0,5	-5,6
	ULS 7	8,2	0,4	13,1	-12,2	-0,7	-4,0
bl1	SLS 1a	7,3	1,5	6,4	-8,3	-0,8	-5,8
	SLS 3	10,7	1,9	9,7	-12,2	-1,5	-8,3
	SLS 4	2,5	0,5	2,3	-2,8	-0,3	-1,8
	SLS 6	2,3	0,4	2,1	-2,5	-0,3	-1,6
	SLS 7	2,0	0,3	1,9	-2,3	-0,3	-1,4
	ULS 1a	10,2	2,3	8,9	-11,7	-1,1	-8,3
	ULS 3	15,0	2,7	13,5	-17,2	-2,1	-11,7

Project: RLL-TLB
 Masttype: EA-3_co
 Mast: 1025

bl1	ULS 4	3,2	0,6	2,9	-3,5	-0,4	-2,3
	ULS 6b	3,8	0,7	3,5	-4,4	-0,5	-2,9
	ULS 7	2,7	0,4	2,6	-3,1	-0,4	-1,9
150ct3f1	SLS 1a	1,1	0,0	17,7	0,0	0,0	-13,0
	SLS 3	0,4	0,0	16,7	0,0	0,0	-11,7
	SLS 4	0,1	0,0	15,3	0,0	0,0	-10,6
	SLS 6	0,1	0,0	10,7	0,0	0,0	-6,1
	SLS 7	0,0	0,0	9,7	0,0	0,0	-5,0
	ULS 1a	1,7	0,0	21,8	0,0	0,0	-16,2
	ULS 3	0,7	0,0	19,8	0,0	0,0	-13,6
	ULS 4	0,2	0,0	16,4	0,0	0,0	-10,8
	ULS 6b	0,3	0,0	13,6	0,0	0,0	-8,0
	ULS 7	0,0	0,0	11,2	0,0	0,0	-4,9
150ct3f2	SLS 1a	2,8	0,0	18,3	-2,5	0,0	-13,6
	SLS 3	1,7	0,0	17,6	-1,9	0,0	-12,6
	SLS 4	1,5	0,0	18,2	-1,7	0,0	-13,6
	SLS 6	0,9	0,0	12,5	-1,1	0,0	-7,8
	SLS 7	0,6	0,0	9,7	-0,8	0,0	-5,0
	ULS 1a	3,9	0,0	22,4	-3,2	0,0	-16,8
	ULS 3	2,1	0,0	20,5	-2,4	0,0	-14,3
	ULS 4	1,5	0,0	19,4	-1,7	0,0	-13,8
	ULS 6b	1,2	0,0	14,2	-1,5	0,0	-8,6
	ULS 7	0,6	0,0	11,0	-0,9	0,0	-4,7
150ct3f3	SLS 1a	0,0	0,0	18,2	0,0	0,0	-13,5
	SLS 3	0,0	0,0	17,5	0,0	0,0	-12,4
	SLS 4	0,0	0,0	17,9	0,0	0,0	-13,2
	SLS 6	0,0	0,0	12,3	0,0	0,0	-7,7
	SLS 7	0,0	0,0	9,7	0,0	0,0	-5,0
	ULS 1a	0,0	0,0	22,3	0,0	0,0	-16,7
	ULS 3	0,0	0,0	20,4	0,0	0,0	-14,2
	ULS 4	0,0	0,0	19,1	0,0	0,0	-13,5
	ULS 6b	0,0	0,0	14,1	0,0	0,0	-8,5
	ULS 7	0,0	0,0	11,1	0,0	0,0	-4,8

Project: ZW-Oost RLL-TLB
 Masttype: EA-3/co
 Mast: 1025



Oplegreacties per randstijl

Auteur: JSN
 Versie: 1.4

Betrouwbaarheidsniveau **Nieuwbouw CC2**
 Referentieperiode **50 jaar**

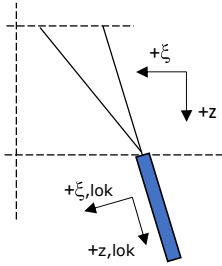

Assenstelsels

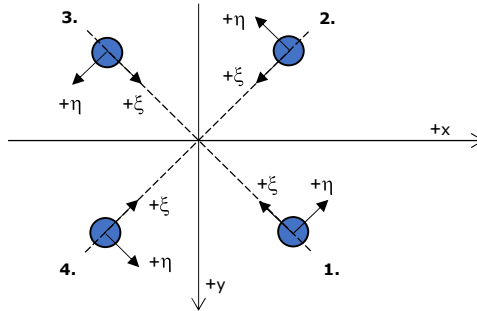

Maximale drukbelasting

Stijl	Combinatie	R _x [kN]	R _y [kN]	R _z [kN]	R _η [kN]	R _ξ [kN]	R _{ξ,lok} [kN]	R _{z,lok} [kN]
1	SPLS 1a_45 Ba All Cts	-165	-167	-814	-1	-234	16	-847
2	SPLS 1a_0 Ba All Cts	-137	130	-662	-5	-189	11	-689
3	ULS 3_135	673	758	-4065	-60	-1012	-81	-4189
4	ULS 1a_105	815	-921	-4835	75	-1227	-72	-4987

Maximale trekbelasting

Stijl	Combinatie	R _x [kN]	R _y [kN]	R _z [kN]	R _η [kN]	R _ξ [kN]	R _{ξ,lok} [kN]	R _{z,lok} [kN]
1	ULS 3_0,9_135	521	628	3346	75	813	87	3442
2	ULS 1a_0,9_105	700	-788	4188	-63	1052	73	4318
3	SPLS 1a_0,9_0,9_45 Ba All Cts	-48	-50	242	2	69	-4	252
4	SPLS 1a_0,9_0,9_0 Ba All Cts	-20	13	91	5	24	1	94

Maximale torsiebelasting (positief)

Stijl	Combinatie	R _x [kN]	R _y [kN]	R _z [kN]	R _η [kN]	R _ξ [kN]	R _{ξ,lok} [kN]	R _{z,lok} [kN]
1	SPLS 3_0,9_90 Ba Ct2	-59	417	1123	337	252	49	1150
2	SPLS 3_0,9_90 Ba Ct2	433	-38	1345	279	333	28	1386
3	SPLS 3_90 Ba Ct2	509	96	-1719	292	-428	-34	-1771
4	SPLS 3_90 Ba Ct2	116	-608	-1990	348	-512	-23	-2055

Maximale torsiebelasting (negatief)

Stijl	Combinatie	R _x [kN]	R _y [kN]	R _z [kN]	R _η [kN]	R _ξ [kN]	R _{ξ,lok} [kN]	R _{z,lok} [kN]
1	SPLS 3_0,9_90 Ba Ct1	369	-27	1021	-280	242	32	1049
2	SPLS 3_0,9_90 Ba Ct1	4	-481	1445	-338	343	45	1484
3	SPLS 3_90 Ba Ct1	57	539	-1667	-341	-422	-26	-1720
4	SPLS 3_90 Ba Ct1	568	-164	-2039	-285	-517	-31	-2104

Combinatie Ftrek+Fh

Stijl	Combinatie	R _x [kN]	R _y [kN]	R _z [kN]	R _η [kN]	R _ξ [kN]	R _{ξ,lok} [kN]	R _{z,lok} [kN]
1	ULS 3_0,9_105	506	626	3321	85	801	92	3415
2	ULS 1a_0,9_105	700	-788	4188	-63	1052	73	4318
3	SPLS 3_90 Ba Ct1	57	539	-1667	-341	-422	-26	-1720
4	SPLS 3_90 Ba Ct2	116	-608	-1990	348	-512	-23	-2055

Permanente belasting

Stijl	Combinatie	R _x [kN]	R _y [kN]	R _z [kN]	R _η [kN]	R _ξ [kN]	R _{ξ,lok} [kN]	R _{z,lok} [kN]
1	SLS 7	240	290	1567	35	375	46	1610
2	SLS 7	240	-290	1567	-35	375	46	1610
3	SLS 7	368	414	-2193	-33	-553	-36	-2261
4	SLS 7	368	-414	-2193	33	-553	-36	-2261

Omhullenden ongeacht stijl

Belasting	Combinatie	R_x [kN]	R_y [kN]	R_z [kN]	R_η [kN]	R_ξ [kN]	$R_{\xi,lok}$ [kN]	$R_{z,lok}$ [kN]
Max. druk	ULS 1a_105	815	-921	-4835	75	-1227	-72	-4987
Max. trek	ULS 1a_0,9_105	700	-788	4188	-63	1052	73	4318
Max. pos. torsie	SPLS 3_90 Ba Ct2	116	-608	-1990	348	-512	-23	-2055
Max. neg. torsie	SPLS 3_90 Ba Ct1	57	539	-1667	-341	-422	-26	-1720
Comb. trek+torsie	ULS 1a_0,9_105	700	-788	4188	-63	1052	73	4318

Maximale drukbelasting SLS

Stijl	Combinatie	R_x [kN]	R_y [kN]	R_z [kN]	R_η [kN]	R_ξ [kN]	$R_{\xi,lok}$ [kN]	$R_{z,lok}$ [kN]
1	ULS 1a_0,9_0,9_45	97	168	963	50	188	71	979
2	SLS 1a_0	151	-207	1133	-40	253	51	1160
3	ULS 3_135	673	758	-4065	-60	-1012	-81	-4189
4	ULS 3_135	752	-848	-4514	68	-1132	-81	-4653

Maximale trekbelasting SLS

Stijl	Combinatie	R_x [kN]	R_y [kN]	R_z [kN]	R_η [kN]	R_ξ [kN]	$R_{\xi,lok}$ [kN]	$R_{z,lok}$ [kN]
1	ULS 3_0,9_135	521	628	3346	75	813	87	3442
2	ULS 3_0,9_135	612	-712	3800	-70	936	84	3913
3	ULS 1a_0,9_0,9_45	212	266	-1483	-38	-338	-61	-1520
4	SLS 1a_0	278	-333	-1759	39	-432	-41	-1811

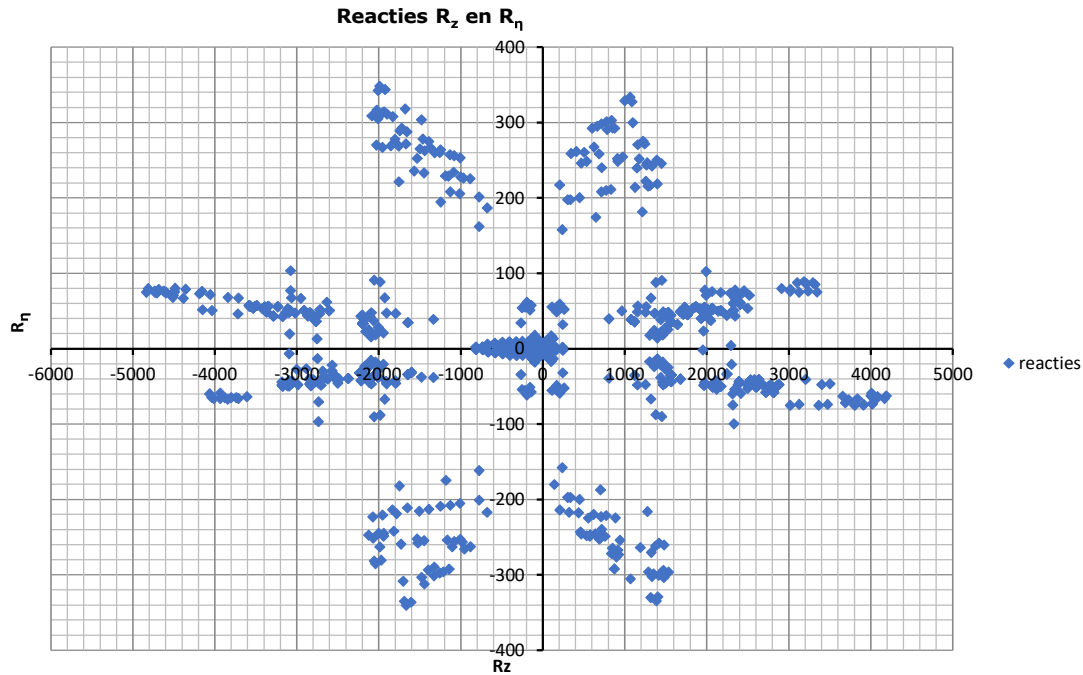



APPENDIX B

Resultaten PLS-TOWER

Deze Appendix bevat de resultaten uit PLS-TOWER voor onderstaande masttype:

- Masttype EA-3/co

Toetsing XEA-profielen voor torsieknik is opgenomen in deze appendix.

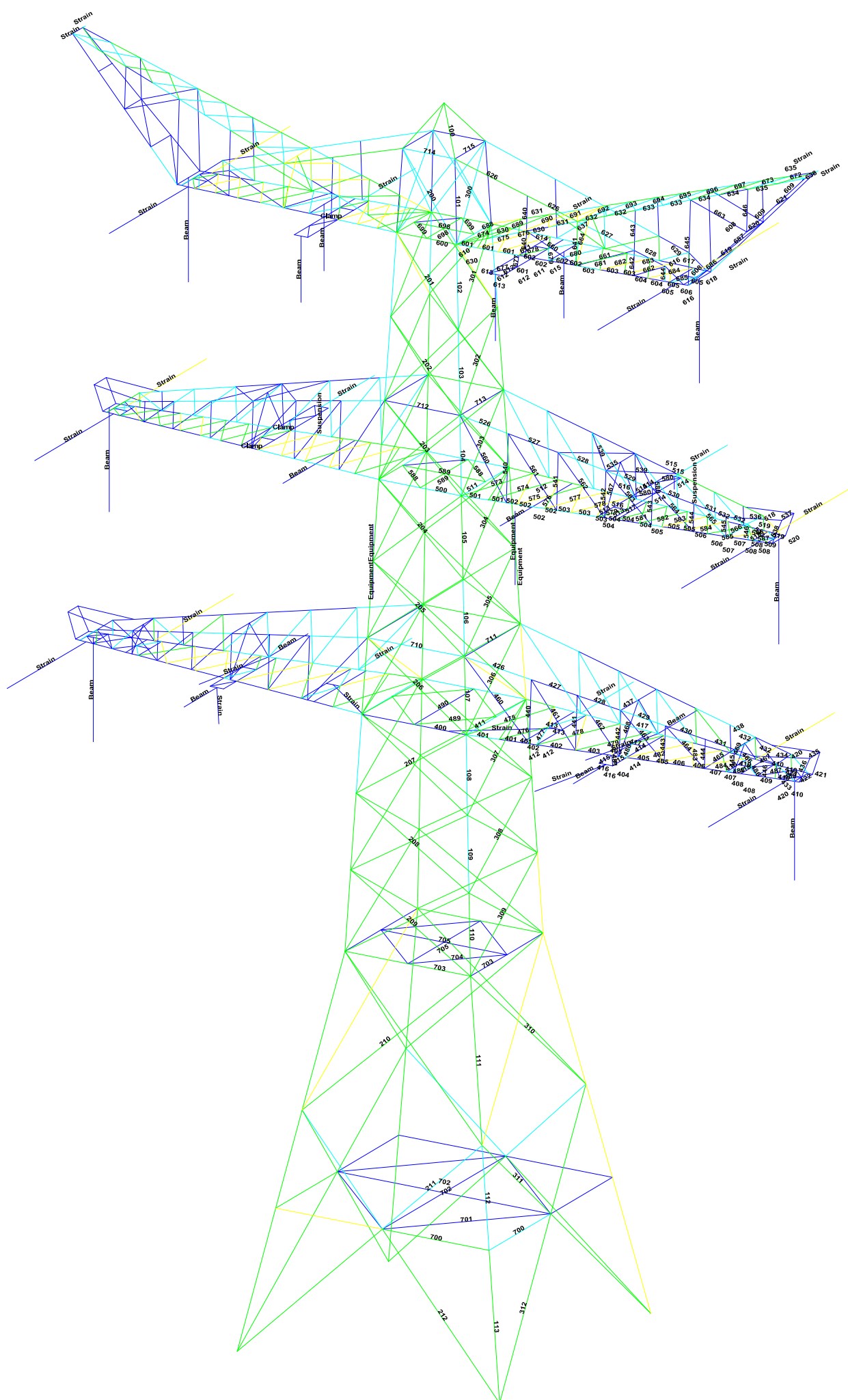

Usage Legend

0	<= 16	< 25
25	<= 16	< 50
50	<= 16	< 75
75	<= 16	< 100
100	<= 16	< 125

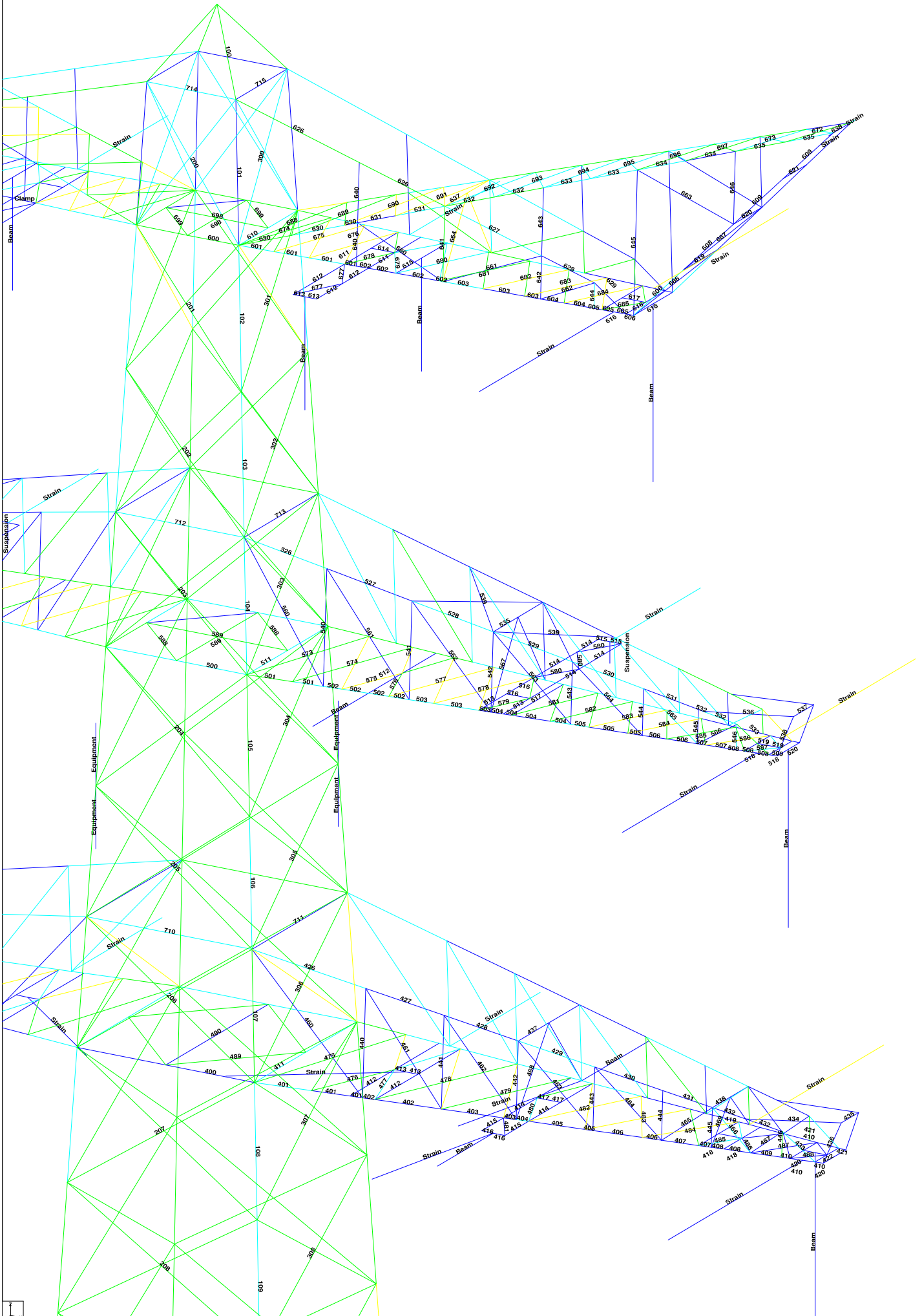

0.5 (m)



Assessment of angle groups

Date 30-05-2021

Author JSN

Version 1.0



RLI-TLB EA-3_00

Table with 25 columns: Group Label, Description, Type, Profile, Steel Qty (kg), #Rein bars, #L, #T, #B, #C, #S, #E, #W, #N, #P, #Q, #R, #S, #T, #U, #V, #W, #X, #Y, #Z, Net Section, Shear (kN), Bending (kNm), U.C. (Comp), U.C. (Tens), Erection (kNm), Erection (kNm).

Angle check

NEN-EN1993-1-1 and EN1993-3-1

Datum: 2021-06-30
Auteur: TBR
Versie: 3.0

Member name	Group 108, 109, 110	Conclusion
Section	XEA 250x250x24	U.C. (compression) 0,79 < 1,0 OK
		U.C. (tension) 0,69 < 1,0 OK

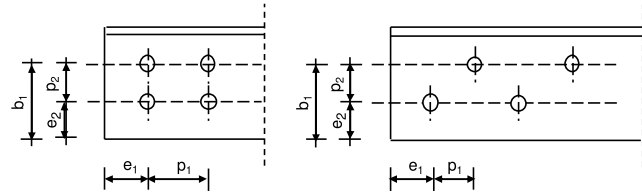
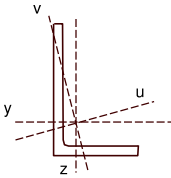

Steel grade **S355**

Member loads

Compressive force $N_{Ed} =$ **-4974 kN**
Tensile force **4516 kN**

Crossing diagonal loads

Applicable: **No**
Min. tensile force diagonal 2 **1 kN**
Max. comp. force diagonal 1 **1 kN**
Position crossing diagonal y-axis **1,00 m**

Construction loads

Vertical construction load **1,0 kN**
Member angle to horizontal **0 °**
Bending around axis **y-axis**

Geometry

System length y-axis $L_{y,buc} =$ **1,72 m**
System length z-axis $L_{z,buc} =$ **1,72 m**
System length v-axis $L_{v,buc} =$ **1,72 m**
System length x-axis $L_{tk,buc} =$ **1,72 m**
Member type **Leg**
Type bracing **Non staggered**

End conditions

Begin **More than one bolt**
End **Continuous**
Restraint code TOWER **C6**

Bolted connection

Bolt type **M24**
Bolt class **8.8**
Number of bolts per leg **7** (28 total)
Shearplane through **Thread**
Bolt pattern **Zigzag**
Bolt pattern (leg-member only) **Staggered**

End distance $e_1 =$ **55 mm** **Ok**
Separation distance // $p_1 =$ **80 mm** **Ok**
Separation distance | $p_2 =$ **55 mm** **Ok**
End distance $e_2 =$ **55 mm** **Ok**
Double strap or single strap **Double**
Tie plate $b_p =$ **180 mm** **OK**
 $t_p =$ **15 mm** **OK**
 $e_2 =$ **40 mm** **OK**

A **23036 mm²**
G **184,3 kg/m**
Partial safety factor $\gamma_{f,Q} =$ **1,50**
Material factors $\gamma_{M0} =$ **1,00**
 $\gamma_{M1} =$ **1,00**
 $\gamma_{M2} =$ **1,25**
Shear strength bolt $F_{v;b;Rd} =$ **135,6 kN**

Slenderness $\lambda_{max} = L / i$ **18 -**
Allowed: **120 OK**

Bending due to vertical construction load

$M_{y,Ed} = 1/4 F_{Ed} L_{pr} =$ **0,65 kNm**
U.C. = **0,00 < 1,00 OK**

Results stability

	$\lambda_{eff,rel}$	λ_{eff}	$\lambda_{eff,mod}$	χ_{buc}	η	$N_{b,Rd} = \eta \chi A_f \gamma_{M1}$
$L_{y,buc} =$ 1,72 m	0,22	1,00	0,22	0,99	1	8131
$L_{z,buc} =$ 1,72 m	0,22	1,00	0,22	0,99	1	8131
$L_{v,buc} =$ 1,72 m	0,23	0,10+0,80	0,23	0,99	1	8081
$L_{tk,buc} =$ 1,72 m	0,63			0,77	1	6274

Bolted connection

	F_{Rd} (kN)	U.C.		F_{Rd} (kN)	U.C.
Compression			Tension		
Cross section angle	$F_{u;Rd} =$ 8178	0,61	Net section angle	$F_{u;Rd} =$ 7177	0,63
Cross section tie plate	$F_{u;Rd} =$ 7668	0,65	Net section tie plate	$F_{u;Rd} =$ 6520	0,69
Shear strength	$F_{v;Rd} =$ 7591	0,66	Block shear	$F_{u;Rd} =$ 10938	0,41
Bearing strength	$F_{b;Rd} =$ 12259	0,41	Shear strength	$F_{v;Rd} =$ 7591	0,59
Combined effect	$F_{v;Rd} =$ 7591	0,66	Bearing strength	$F_{b;Rd} =$ 12100	0,37
		elastisch	Combined effect	$F_{v;Rd} =$ 7591	0,59
					elastisch

Angle check

NEN-EN1993-1-1 and EN1993-3-1

Datum: 2021-06-30
Auteur: TBR
Versie: 3.0

Member name	Group 111,112 en 113	Conclusion
Section	XEA 250x250x24	U.C. (compression) 0,86 < 1,0 OK
		U.C. (tension) 0,69 < 1,0 OK

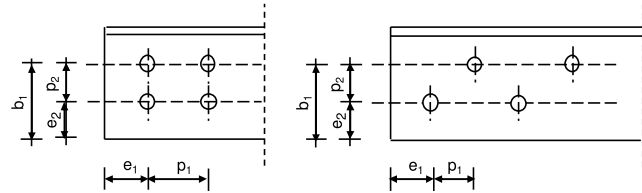
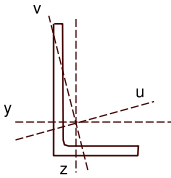

Steel grade **S355**

Member loads

Compressive force $N_{Ed} =$ **-5319 kN**
Tensile force **4493 kN**

Crossing diagonal loads

Applicable: **No**
Min. tensile force diagonal 2 **1 kN**
Max. comp. force diagonal 1 **1 kN**
Position crossing diagonal y-axis **1,00 m**

Construction loads

Vertical construction load **1,0 kN**
Member angle to horizontal **0 °**
Bending around axis **y-axis**

Geometry

System length y-axis $L_{y,buc} =$ **2,02 m**
System length z-axis $L_{z,buc} =$ **2,02 m**
System length v-axis $L_{v,buc} =$ **2,02 m**
System length x-axis $L_{tk,buc} =$ **2,02 m**
Member type **Leg**
Type bracing **Non staggered**

End conditions

Begin **More than one bolt**
End **Continuous**
Restraint code TOWER **C6**

Bolted connection

Bolt type **M24**
Bolt class **8.8**
Number of bolts per leg **7** (28 total)
Shearplane through **Thread**
Bolt pattern **Zigzag**
Bolt pattern (leg-member only) **Staggered**

End distance $e_1 =$ **55 mm** **Ok**
Separation distance // $p_1 =$ **80 mm** **Ok**
Separation distance | $p_2 =$ **80 mm** **Ok**
End distance $e_2 =$ **50 mm** **Ok**
Double strap or single strap **Double**
Tie plate $b_p =$ **180 mm** **OK**
 $t_p =$ **15 mm** **OK**
 $e_2 =$ **40 mm** **OK**

A **23036 mm²**
G **184,3 kg/m**
Partial safety factor $\gamma_{f,Q} =$ **1,50**
Material factors $\gamma_{M0} =$ **1,00**
 $\gamma_{M1} =$ **1,00**
 $\gamma_{M2} =$ **1,25**
Shear strength bolt $F_{v;b;Rd} =$ **135,6 kN**

Slenderness

$\lambda_{max} = L / i$ **21 -**
Allowed: **120 OK**

Bending due to vertical construction load

$M_{y,Ed} = 1/4 F_{Ed} L_{pr} =$ **0,76 kNm**
U.C. = **0,00 < 1,00 OK**

Results stability

	$\lambda_{eff,rel}$	λ_{eff}	$\lambda_{eff,mod}$	χ_{buc}	η	$N_{b,Rd} = \eta \chi A_f \gamma_{M1}$
$L_{y,buc} =$ 2,02 m	0,25	1,00	0,25	0,98	1	8021 0,66
$L_{z,buc} =$ 2,02 m	0,25	1,00	0,25	0,98	1	8021 0,66
$L_{v,buc} =$ 2,02 m	0,27	0,10+0,80	0,27	0,97	1	7961 0,67
$L_{tk,buc} =$ 2,02 m	0,64			0,76	1	6205 0,86

Bolted connection

	F_{Rd} (kN)	U.C.		F_{Rd} (kN)	U.C.
Compression			Tension		
Cross section angle	$F_{u;Rd} =$ 8178	0,65	Net section angle	$F_{u;Rd} =$ 7177	0,63
Cross section tie plate	$F_{u;Rd} =$ 7668	0,69	Net section tie plate	$F_{u;Rd} =$ 6520	0,69
Shear strength	$F_{v;Rd} =$ 7591	0,70	Block shear	$F_{u;Rd} =$ 10938	0,41
Bearing strength	$F_{b;Rd} =$ 12259	0,43	Shear strength	$F_{v;Rd} =$ 7591	0,59
Combined effect	$F_{v;Rd} =$ 7591	0,70 elastisch	Bearing strength	$F_{b;Rd} =$ 12100	0,37
			Combined effect	$F_{v;Rd} =$ 7591	0,59 elastisch

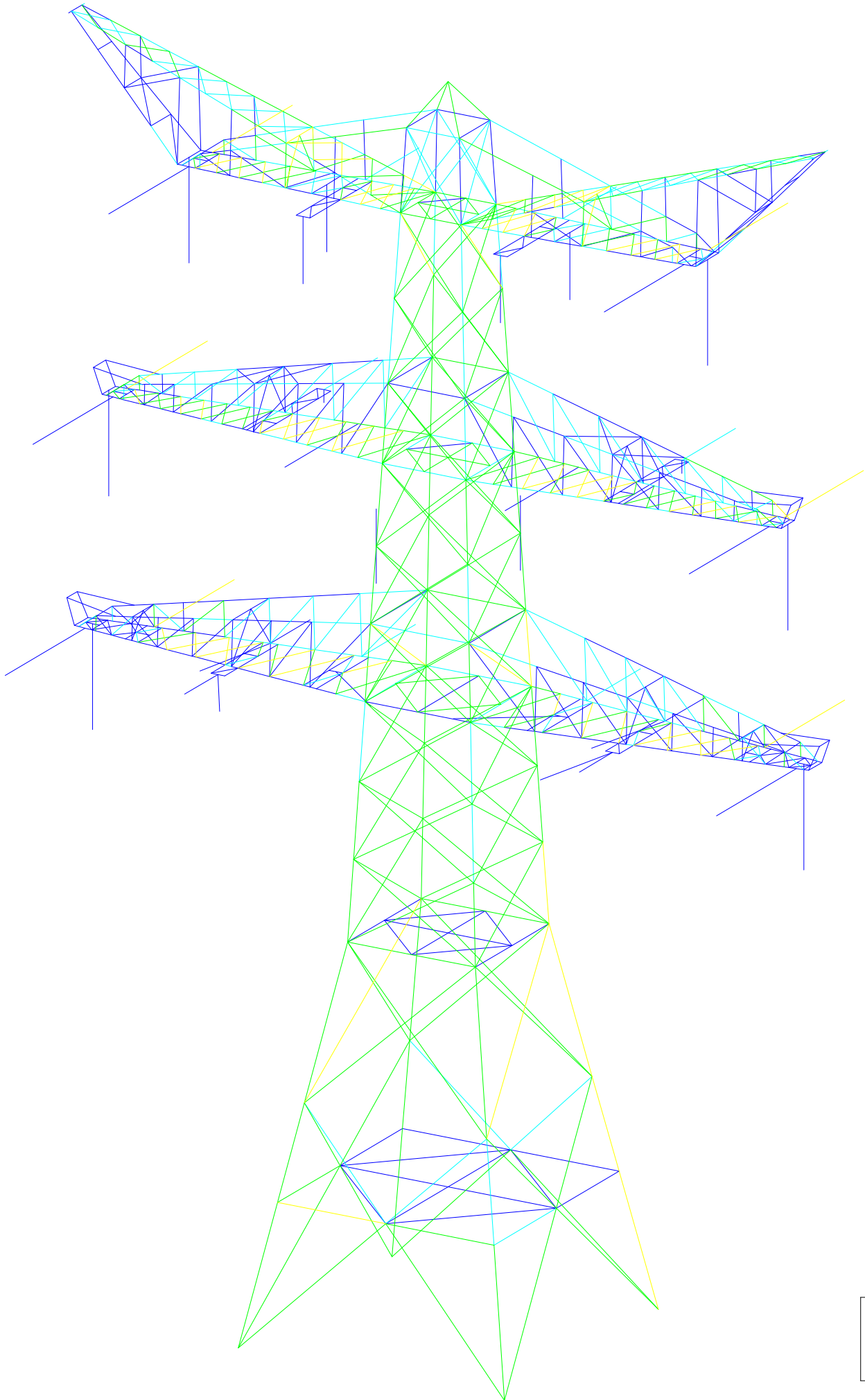

% Usage Legend

0	≤	%	<	25
25	≤	%	<	50
50	≤	%	<	75
75	≤	%	<	100
100	≤	%		

2 (m)

APPENDIX C

Knikverkorters

Niet in PLS-TOWER gemodelleerde elementen in de constructie worden aanvullend getoetst. Hieronder vallen de knikverkorters van de randstijl en profielen onderdeel van stabiliteitsverbanden. De staven worden getoetst op:

- voldoende trek- of druksterkte als steungevend profiel voor randstijl, 1% van de knikcapaciteit van de randstijl;
- slankheid;
- klimbelasting

Voor de beloopbaarheid zijn staven in de traverse aanwezig. Deze zijn niet constructief (voorzien van slobgaten) en worden enkel getoetst op de klimbelasting van 1,0 kN. Zie hoofdstuk 4.2.5 en 5.7.2. van het uitgangspuntenrapport.

Profielen uit horizontaalverbanden van het onderstuk zijn in PLS-TOWER aanwezig maar worden in deze Appendix aanvullend getoetst op buiging. Profielafmeting en boutverbinding uit PLS-TOWER is leidend.

Overzicht knikverkorters – EA-3/co

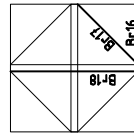
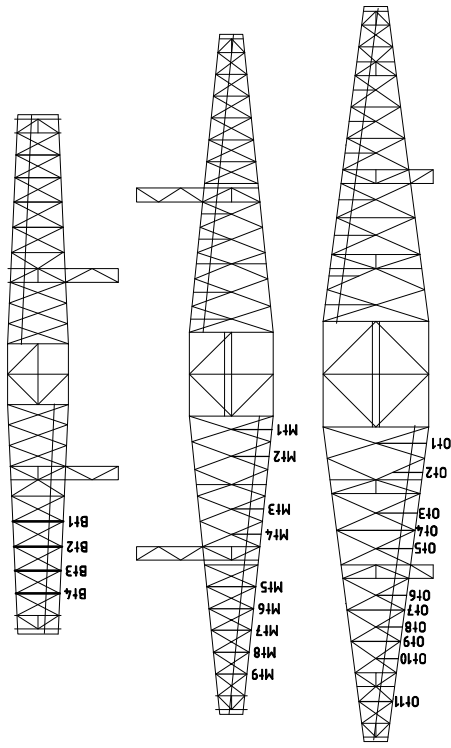

Tussenschot +16,4m

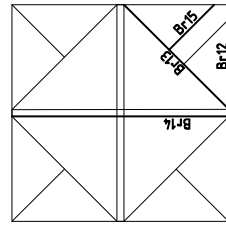

Tussenschot +6,2m

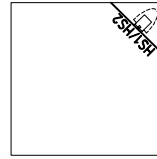

Standaard frame

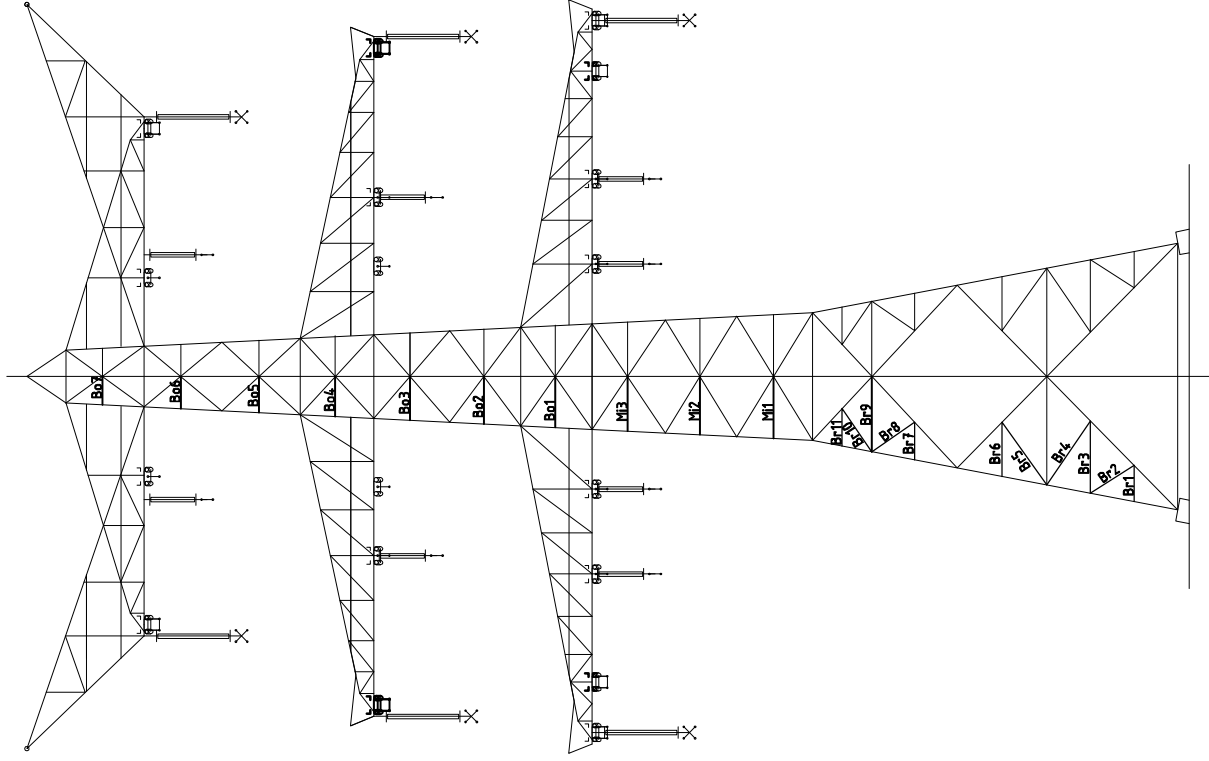



Date: 2021-06-30
 Author: JSN
 Version: 1.9

Redundant members

RLI-TLB
 EA-3_CO

Posnr.	Section	Schematization	Profile	Steel Quality	Bolt Quality	Length (m)	Angle (°)	Slenderness	Normal Force (kN)	Moment (kNm)	Buckling Cap. (kN)	Shear Cap. (kN)	Bearing Cap. (kN)	Net Section Cap. (kN)	Moment Cap. (kNm)	Highest U.C.	Max. usage	Notes
Br1	Broekstuk	Enkele staaf	L70x6	S355J0	M20	8.8	1.57	0	114	62.1	0.59	88.3	94.1	71.3	112.9	1.99	0.87	Bearing
Br2	Broekstuk	Enkele staaf	L70x7	S355J0	M20	8.8	2.25	57	165	62.1	0.00	63.4	94.1	83.2	131.7	2.23	0.98	Buckling
Br3	Broekstuk	Enkele staaf	L90x8	S355J0	M20	8.8	3.15	0	178	62.1	1.18	83.7	94.1	95.0	213.2	4.34	0.74	Buckling
Br4	Broekstuk	Enkele staaf	L90x8	S355J0	M20	8.8	3.37	34	191	62.1	0.00	75.6	94.1	95.0	213.2	4.34	0.82	Buckling
Br5	Broekstuk	Enkele staaf	L90x8	S355J0	M20	8.8	3.36	35	191	62.1	0.00	76.0	94.1	95.0	213.2	4.34	0.82	Buckling
Br6	Broekstuk	Enkele staaf	L80x8	S355J0	M20	8.8	2.36	0	151	62.1	0.88	93.7	94.1	95.0	181.9	3.33	0.66	Buckling
Br7	Broekstuk	Enkele staaf	L70x7	S355J0	M20	8.8	1.64	0	119	62.1	0.61	84.1	94.1	71.3	112.9	1.99	0.87	Bearing
Br8	Broekstuk	Enkele staaf	L70x7	S355J0	M20	8.8	2.26	55	165	62.1	0.00	63.3	94.1	83.2	131.7	2.23	0.98	Buckling
Br9	Broekstuk	Enkele staaf	L90x8	S355J0	M20	8.8	3.27	0	186	62.1	1.23	79.0	94.1	95.0	213.2	4.34	0.79	Buckling
Br10	Broekstuk	Enkele staaf	L70x6	S355J0	M20	8.8	2.29	34	167	62.1	0.00	62.1	94.1	83.2	131.7	2.23	1.00	Buckling
Br11	Broekstuk	Enkele staaf	L70x6	S355J0	M20	8.8	1.64	0	119	62.1	0.61	84.1	94.1	71.3	112.9	1.99	0.87	Bearing
Br12	Tussenschot +6,2m	Enkele staaf	L100x8	S355J0	M16	8.8	4.72	0	240	0.0	1.77	59.5	60.3	69.7	257.2	5.49	0.34	Bending
Br13	Tussenschot +6,2m	Kniksteun op 0,5L	L100x8	S355J0	M16	8.8	6.46	0	210	0.0	2.42	61.4	60.3	69.7	257.2	7.19	0.34	Bending
Br14	Tussenschot +6,2m	Kruisende staaf halverwege	L100x8	S355J0	M16	8.8	9.44	0	240	0.0	1.77	59.5	60.3	69.7	257.2	7.19	0.25	Bending
Br15	Tussenschot +6,2m	Enkele staaf	L70x6	S355J0	M16	8.8	3.23	0	235	0.0	1.21	32.1	60.3	52.3	122.3	1.99	0.64	Bending
Br16	Tussenschot +16,4m	Kniksteun op 0,5L	L130x12	S355J0	M16	8.8	5.56	0	140	0.0	2.09	202.0	60.3	104.5	620.9	17.91	0.12	Bending
Br17	Tussenschot +16,4m	Enkele staaf	L90x8	S355J0	M16	8.8	3.72	0	211	0.0	1.39	65.1	60.3	69.7	225.8	4.34	0.33	Bending
Br18	Tussenschot +16,4m	Kruisende staaf halverwege	L90x8	S355J0	M16	8.8	5.56	0	158	0.0	1.04	99.9	60.3	69.7	225.8	5.70	0.18	Bending
M1	Tussenstuk1	Enkele staaf	L80x8	S355J0	M20	8.8	2.70	0	173	62.7	1.01	77.6	94.1	95.0	181.9	3.33	0.81	Buckling
M2	Tussenstuk2	Enkele staaf	L80x8	S355J0	M20	8.8	2.53	0	163	62.7	0.95	84.8	94.1	95.0	181.9	3.33	0.74	Buckling
M3	Tussenstuk1	Enkele staaf	L80x8	S355J0	M20	8.8	2.38	0	152	62.7	0.89	92.7	94.1	95.0	181.9	3.33	0.68	Buckling
M3	Tussenstuk2	Enkele staaf	L70x6	S355J0	M16	8.8	2.22	0	162	38.0	0.83	56.3	60.3	52.3	122.3	1.99	0.73	Bearing
Bo1	Bovenstuk1	Enkele staaf	L70x6	S355J0	M16	8.8	2.07	0	151	38.0	0.78	62.0	60.3	52.3	122.3	1.99	0.73	Bearing
Bo2	Bovenstuk1	Enkele staaf	L70x6	S355J0	M16	8.8	2.07	0	151	38.0	0.78	62.0	60.3	52.3	122.3	1.99	0.73	Bearing
Bo3	Bovenstuk1	Enkele staaf	L60x6	S355J0	M16	8.8	1.90	0	163	38.0	0.71	47.5	60.3	52.3	98.8	1.4	0.80	Buckling
Bo4	Bovenstuk2	Enkele staaf	L50x5	S355J0	M16	8.8	1.74	0	179	17.0	0.65	28.8	60.3	41.3	43.1	0.8	0.83	Bending
Bo5	Bovenstuk2	Enkele staaf	L50x5	S355J0	M16	8.8	1.58	0	162	16.5	0.59	33.3	60.3	41.3	43.1	0.8	0.75	Bending
Bo6	Bovenstuk2	Enkele staaf	L50x5	S355J0	M16	8.8	1.41	0	144	16.5	0.53	39.0	60.3	41.3	43.1	0.8	0.67	Bending
Bo7	Bovenstuk2	Enkele staaf	L55x6	S355J0	M16	8.8	1.24	0	127	7.4	0.46	46.0	60.3	41.3	43.1	0.8	0.59	Bending
O1	Ondertraverse	Enkele staaf	L55x6	S355J0	M16	8.8	2.21	0	206	0.0	0.83	30.7	60.3	51.5	75.3	1.2	0.74	Bending
O2	Ondertraverse	Enkele staaf	L50x5	S355J0	M16	8.8	1.30	0	134	0.0	0.49	43.1	60.3	41.3	43.1	0.8	0.62	Bending
O3	Ondertraverse	Enkele staaf	L50x5	S355J0	M16	8.8	1.81	0	186	0.0	0.68	27.3	60.3	41.3	43.1	0.8	0.86	Bending
O4	Ondertraverse	Enkele staaf	L70x6	S355J0	M16	8.8	3.42	0	249	0.0	1.28	29.3	60.3	52.3	122.3	2.0	0.67	Bending
O5	Ondertraverse	Enkele staaf	L50x5	S355J0	M16	8.8	1.60	0	165	0.0	0.60	32.5	60.3	41.3	43.1	0.8	0.77	Bending
O6	Ondertraverse	Enkele staaf	L50x5	S355J0	M16	8.8	1.34	0	137	0.0	0.50	41.6	60.3	41.3	43.1	0.8	0.64	Bending
O7	Ondertraverse	Enkele staaf	L55x6	S355J0	M16	8.8	2.51	0	234	0.0	0.94	25.2	60.3	51.5	75.3	1.2	0.84	Bending
O8	Ondertraverse	Enkele staaf	L50x5	S355J0	M16	8.8	1.16	0	119	0.0	0.43	49.9	60.3	41.3	43.1	0.8	0.55	Bending
O9	Ondertraverse	Enkele staaf	L55x6	S355J0	M16	8.8	2.15	0	200	0.0	0.80	32.0	60.3	51.5	75.3	1.2	0.72	Bending
O10	Ondertraverse	Enkele staaf	L50x5	S355J0	M16	8.8	0.98	0	100	0.0	0.37	60.3	60.3	41.3	43.1	0.8	0.40	Bending
O11	Ondertraverse	Enkele staaf	L50x5	S355J0	M16	8.8	1.46	0	150	0.0	0.55	37.0	60.3	41.3	43.1	0.8	0.70	Bending
M1	Middentraverse	Enkele staaf	L50x5	S355J0	M16	8.8	1.78	0	182	0.0	0.67	28.0	60.3	41.3	43.1	0.8	0.85	Bending
M2	Middentraverse	Enkele staaf	L50x5	S355J0	M16	8.8	1.65	0	169	0.0	0.62	31.3	60.3	41.3	43.1	0.8	0.79	Bending
M3	Middentraverse	Enkele staaf	L50x5	S355J0	M16	8.8	1.41	0	145	0.0	0.53	38.7	60.3	41.3	43.1	0.8	0.67	Bending
M4	Middentraverse	Enkele staaf	L50x5	S355J0	M16	8.8	1.29	0	133	0.0	0.48	43.5	60.3	41.3	43.1	0.8	0.62	Bending
M5	Middentraverse	Enkele staaf	L55x6	S355J0	M16	8.8	2.14	0	199	0.0	0.80	32.3	60.3	51.5	75.3	1.2	0.72	Bending
M6	Middentraverse	Enkele staaf	L50x5	S355J0	M16	8.8	1.94	0	179	0.0	0.73	24.5	60.3	41.3	43.1	0.8	0.93	Bending
M7	Middentraverse	Enkele staaf	L50x5	S355J0	M16	8.8	1.75	0	179	0.0	0.66	28.7	60.3	41.3	43.1	0.8	0.84	Bending
M8	Middentraverse	Enkele staaf	L50x5	S355J0	M16	8.8	1.55	0	160	0.0	0.58	34.0	60.3	41.3	43.1	0.8	0.74	Bending
M9	Middentraverse	Enkele staaf	L50x5	S355J0	M16	8.8	1.36	0	140	0.0	0.51	40.7	60.3	41.3	43.1	0.8	0.65	Bending



Redundant members

RLI-TLB
EA-3_co

Date: 2021-06-30
Author: JSN
Version: 1.9

Posnr.	Section	Schematization	Profile	Steel Quality	Bolt Quality	Length (m)	Angle (°)	Slenderness	Normal Force (kN)	Moment (kNm)	Buckling Cap. (kN)	Shear Cap. Bolt (kN)	Bearing Cap. (kN)	Net Section Cap. (kN)	Moment Cap. (kNm)	Highest U.C.	Max. usage	Notes
B1	Bovenraverse	Enkele staaf	L55x6	S35510	M16	8.8	2.19	0	205	0.0	0.82	31.0	60.3	51.5	75.3	1.2	0.74	Bending
B2	Bovenraverse	Enkele staaf	L55x6	S35510	M16	8.8	2.09	0	195	0.0	0.78	33.2	60.3	51.5	75.3	1.2	0.70	Bending
B3	Bovenraverse	Enkele staaf	L50x5	S35510	M16	8.8	2.00	0	205	0.0	0.75	23.4	60.3	41.3	43.1	0.8	0.96	Bending
B4	Bovenraverse	Enkele staaf	L50x5	S35510	M16	8.8	1.91	0	196	0.0	0.72	25.1	60.3	41.3	43.1	0.8	0.91	Bending
HS1	High Step	Enkele staaf	L80x6	S35510	M16	8.8	3.25	0	207	0.0	2.44	45.2	60.3	52.3	145.8	2.7	0.95	Bending
HS2	High Step	Enkele staaf	L70x7	S35510	M16	8.8	2.80	0	205	0.0	2.10	46.0	60.3	61.0	142.7	2.2	0.97	Bending

1) Also checked in PLS-TOWER

APPENDIX D

Blokdeuvels

Het uitgangspunt voor de berekening van de ingestorte rand met blokdeuvels zijn de belastingen op de fundatie uit de uitvoer vanuit PLS-TOWER. De belastingen in de richting van de randstijl zijn van toepassing. De controles zijn uitgevoerd met een spreadsheet. Vanwege de helling van de drukdiagonaal wordt per krachtsrichting bepaald hoeveel deuvels effectief zijn, hierdoor is het aantal ingevoerde deuvels in de berekening kleiner dan het aantal deuvels op de principetekening.

Er wordt voor gekozen om de blokdeuvels universeel uit te werken op basis van het profiel van de randstijl, dit betreft een XEA250x250x24-profiel en heeft betrekking op de volgende masttypen:

- Masttype HA+0/c, HA+0/ci, HA+3/c, HA+3/ca en HA+6/c;
- Masttype HB+0/c en HB+6/c;
- Masttype HC+0/c;
- Masttype WA+0/c en WA+6/c;
- Masttype WB+0/c;
- Masttype EA-3/co.

De blokdeuvels worden getoetst op de maatgevende belasting van bovenstaande masttypen. De belasting is opgenomen in Appendix A van het betreffende masttype, masttype HC+0/c is maatgevend. De optredende belastingen van masttype HC+0/c zijn 5503kN (druk) en -4739kN (trek), deze worden ruim naar boven afgerond op **5600kN** (druk) en **-4800kN** (trek). Met deze belastingen worden alle masttypen geborgd en hebben eventuele kleine aanpassingen geen invloed op deze uitwerking.

Voor de EA-3/co blijkt uit onderstaande tabel een maximale drukkracht van **4987kN** en een maximale trekkracht van **4318kN**. De belasting blijft onder de maatgevende waarden van de HC+0/c.

Omhullenden ongeacht stijl		R_x	R_y	R_z	R_{η}	R_{ξ}	$R_{\xi,lok}$	$R_{z,lok}$
Belasting	Combinatie	[kN]	[kN]	[kN]	[kN]	[kN]	[kN]	[kN]
Max. druk	ULS 1a_105	815	-921	-4835	75	-1227	-72	-4987
Max. trek	ULS 1a_0,9_105	700	-788	4188	-63	1052	73	4318
Max. pos. torsie	SPLS 3_90 Ba Ct2	116	-608	-1990	348	-512	-23	-2055
Max. neg. torsie	SPLS 3_90 Ba Ct1	57	539	-1667	-341	-422	-26	-1720
Comb. trek+torsie	ULS 1a_0,9_105	700	-788	4188	-63	1052	73	4318

Principe blokdeuvels - combi-hoek-, combi-wissel en combi-eindmasten

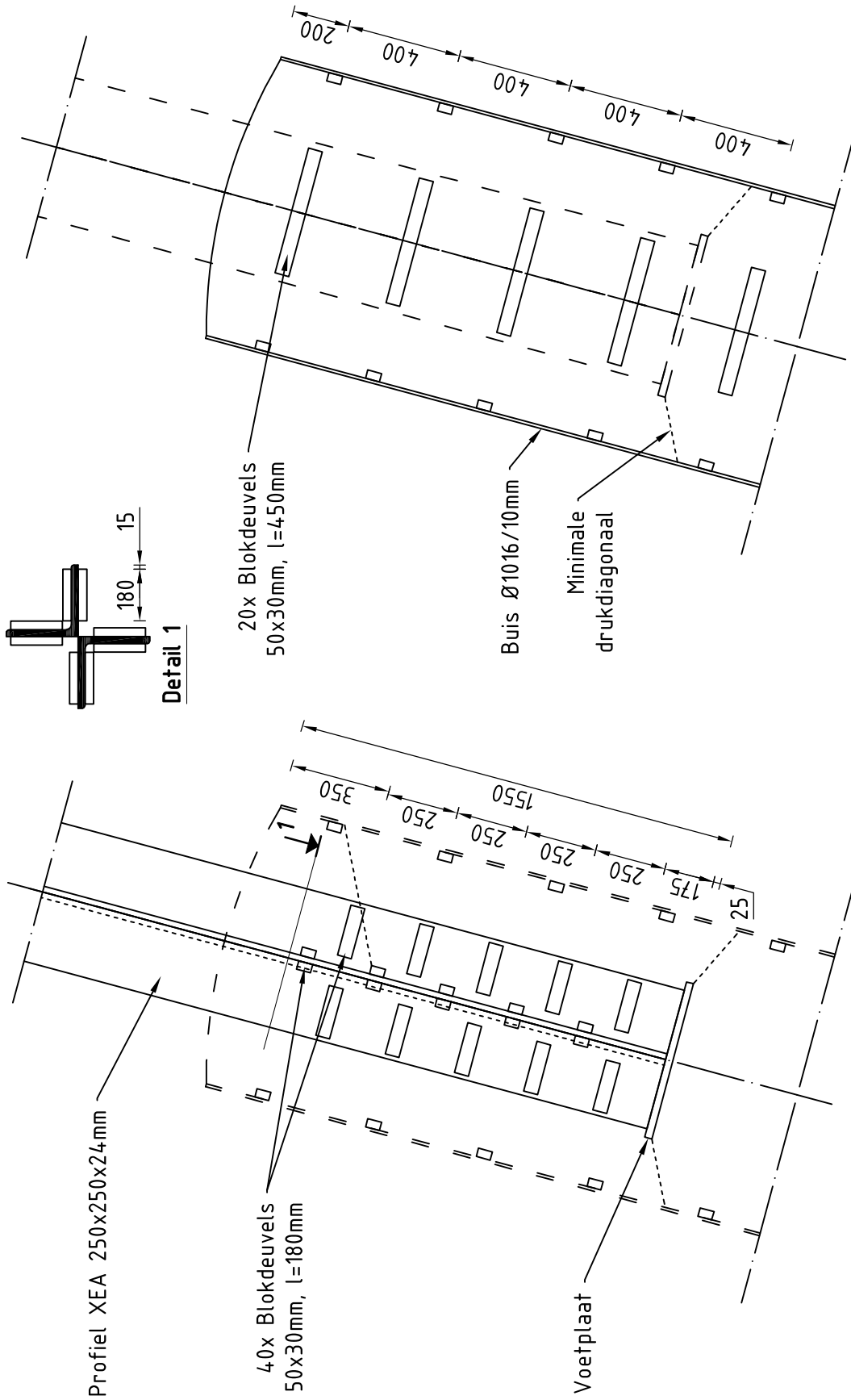

Algemene opmerkingen

- Aarding niet aangegeven
- Spiraalwapening niet aangegeven

Project: RLL-TBG
 Mast: HA-B-C/c & WA-B/c & EA-co

Shear blocks

NEN-EN 1993-1-1 en NEN-EN 1994-1-1

Datum: 2021-07-09

Auteur: TBR

Versie: 1.5

Load			Results		
Compression	$F_{Ed,c}$	5600 kN	Compression	U.C.	0.87 < 1,00 OK
Tension	$F_{Ed,t}$	4800 kN	Tension	U.C.	0.78 < 1,00 OK

Main leg

Profile		XEA 250x250x24
Type		Double (XEA)
Steel material		S355
Cross section		22934 mm ²
Axial capacity	N_{pl}	8142 kN
Width	b	500 mm
Thickness	t	24 mm
Length in concrete		1550 mm

Capacity shear blocks main leg

$A_{f1} = A_{f1,out} + A_{f1,in} =$	10800 mm ²
$A_{f2} = A_{f2,out} + A_{f2,in} =$	31807.5 mm ²
Slope	1 : 5
$C_A = \sqrt{(A_{f2}/A_{f1})} =$	1.72
$f_{jd} = C_A \times f_{cd} =$	25.8 N/mm ²
$F_{Rd,c} = n_c \times A_{f1} \times f_{jd} =$	4459 kN
$F_{Rd,t} = n_t \times A_{f1} \times f_{jd} =$	4459 kN

Shear blocks main leg

Sides		2
Width	b	50 mm
Thickness	h	30 mm
Length - outside	L_{out}	180 mm
Length - inside	L_{in}	180 mm
Eccentricity	e	15 mm
Welds	a	5 mm
c.t.c. separation	s	250 mm
Number for compr.	n_c	16 -
Number for tension	n_t	16 -

Capacity foot plate

$k_d =$	1.73 -
$f_{jd} = C_A \times f_{cd} =$	26.0 N/mm ²
$c = t\sqrt{(f_{yd} / 3f_{jd})} =$	53 mm
$m^* = \min(c, m) =$	30 mm
Type foot plate	Extending
Effective for	Compr. and tension
$A_{p,c} =$	86534 mm ²
$F_{Rd,c} = A_{p,druk} \times f_{jd} =$	2254 kN
$A_{p,t} =$	63600 mm ²
$F_{Rd,t} = A_{p,t} \times f_{jd} =$	1657 kN

Foot plate

Thickness	t	25 mm
Ext. length	m	30 mm
Welds	a	5 mm

Capacities

$F_{rd,c,plate} =$	2254 kN
$F_{rd,blocks,c} =$	4459 kN
$F_{rd,c} = F_{rd,blk} + F_{rd,footplate} =$	6713 kN
U.C. compression	0.83 < 1,00 OK
Welds foot plate (see next page)	2454 kN
$F_{rd,t} = \min. (\text{welds} / \text{foot plate}) =$	1657 kN
$F_{rd,blocks,t} =$	4459 kN
$F_{rd,t} = F_{rd,blk} + F_{rd,footplate} =$	6116 kN
U.C. tension	0.78 < 1,00 OK
U.C. welds	0.47 < 1,00 OK

Pile

Name		Buispaal
Diameter		1016 mm
Thickness		10 mm
Cross section		31604 mm ²
Steel material		S355
Capacity		11220 kN
Concrete strength		C30/37

Shear blocks pile

Width	b	50 mm
Thickness	h	30 mm
Length	L	450 mm
Welds	a	5 mm
c.t.c. separation	s	400 mm
Number for compr.	n_c	16 -
Number for tension	n_t	16 -
Blocks per row	n_{bl}	4 -
Effectivity of total	C_{red}	100% -

Capacity shear blocks pile

$A_{f1} =$	13500 mm ²
$A_{f2} =$	53076 mm ²
$C_A = \sqrt{(A_{f2}/A_{f1})} =$	1.98 -
$f_{jd} = k_d \times f_{cd} =$	29.8 N/mm ²
$F_{Rd,c} = n_c \times A_{f1} \times f_{jd} \times C_{red} =$	6440 kN
U.C. compression	0.87 < 1,00 OK
$F_{Rd,t} = n_t \times A_{f1} \times f_{jd} \times C_{red} =$	6440 kN
U.C. tension	0.75 < 1,00 OK
U.C. welds	0.45 < 1,00 OK

Design value concrete strength

Material factor	γ_c	1.5
Add. mat. factor	γ_m	1.33 -
$f_{cd} =$		15.0 N/mm ²

"Splitting" of pile

Spread of forces		45 °
Length force flow		1052 mm
Splitting force		2281 kN/m
Yield strength wall	$f_{yd} =$	355 N/mm ²
Capacity tubular pile		7100 kN/m
U.C.		0.32 < 1,00 OK

Steel tower stub

Yield strength	$f_{yd} =$	355 N/mm ²
Tensile strength	$f_{ud} =$	490 N/mm ²

Project: RLL-TBG
 Mast: HA-B-C/c & WA-B/c & EA-co

Welds of shear blocks of main leg

Out-of-plane loading

Plate

t = 50 mm
 Grade S355
 $f_{yd} = 355 \text{ N/mm}^2$
 $f_u = 490 \text{ N/mm}^2$

Member forces

Factor 1.2
 $F_{t,Ed} = 0 \text{ kN}$
 $F_{v,Ed} = F_{rd,c} / n = 334 \text{ kN}$
 $F_{v//,Ed} = 0 \text{ kN}$
 $M_{Ed} = 1/2 b / h \times F_{v,Ed} = 5.02 \text{ kNm}$

Check

$\sigma_{w,Ed} = 203 \text{ N/mm}^2 \leq$
 $\sigma_1 = 102 \text{ N/mm}^2 \leq$

Welds

a = 5 mm
 l = 360 mm
 $\beta_w = 0.9 -$
 $\gamma_{M2} = 1.25 -$

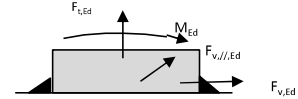

Stress components

$\sigma_1 = \tau_1 = F_{t,Ed} \sqrt{2} / 4al = 0 \text{ N/mm}^2$
 $\sigma_1 = \tau_1 = F_{v,Ed} \sqrt{2} / 4al = 66 \text{ N/mm}^2$

 66 N/mm^2
 $b^* = b + 2/3av^2 = 54.7 \text{ mm}$
 $\sigma_1 = \tau_1 = 0.706M_{Ed} / al b^* = 36 \text{ N/mm}^2$
 $\tau_{//} = F_{v//,Ed} / 2al = 0 \text{ N/mm}^2$
 $\sigma_{w,Ed} = \sqrt{(\sigma_1^2 + 3\tau_1^2 + 3\tau_{//}^2)} = 203 \text{ N/mm}^2$

$f_u / \beta_w \gamma_{M2} = 436 \text{ N/mm}^2$ U.C. = **0.47 OK**
 $0.9f_u / \gamma_{M2} = 353 \text{ N/mm}^2$ U.C. = **0.29 OK**

Welds of shear blocks of pile

Out-of-plane loading

Plate

t = 50 mm
 Grade S355
 $f_{yd} = 355 \text{ N/mm}^2$
 $f_u = 490 \text{ N/mm}^2$

Member forces

Factor 1.2
 $F_{t,Ed} = 1/2 b / h \times F_{v,Ed} = 145 \text{ kN}$
 $F_{v,Ed} = 483 \text{ kN}$
 $F_{v//,Ed} = 0 \text{ kN}$
 $M_{Ed} = 0.00 \text{ kNm}$

Check

$\sigma_{w,Ed} = 197 \text{ N/mm}^2 \leq$
 $\sigma_1 = 99 \text{ N/mm}^2 \leq$

Welds

a = 5 mm
 l = 450 mm
 $\beta_w = 0.9 -$
 $\gamma_{M2} = 1.25 -$

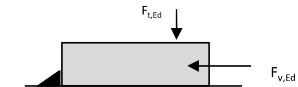

Stress components

$\sigma_1 = \tau_1 = F_{t,Ed} \sqrt{2} / 2al = 23 \text{ N/mm}^2$
 $\sigma_1 = \tau_1 = F_{v,Ed} \sqrt{2} / 2al = 76 \text{ N/mm}^2$

 99 N/mm^2
 $\tau_{//} = F_{v//,Ed} / 2al = 0 \text{ N/mm}^2$
 $\sigma_{w,Ed} = \sqrt{(\sigma_1^2 + 3\tau_1^2 + 3\tau_{//}^2)} = 197 \text{ N/mm}^2$

$f_u / \beta_w \gamma_{M2} = 436 \text{ N/mm}^2$ U.C. = **0.45 OK**
 $0.9f_u / \gamma_{M2} = 353 \text{ N/mm}^2$ U.C. = **0.28 OK**

Welds of foot plate

$f_u / \beta_w \gamma_{M2} = 436 \text{ N/mm}^2$
 Weld size a = 5 mm
 Length l = 2b + 2b - t = 1952 mm
 Capacity $F_{Rd} = a \times l \times f_{w,d} / \sqrt{3} = 2454 \text{ kN}$



APPENDIX E

Liggers

CONTROLE LIGGERS EA-3/CO

In onderstaande tabel en figuur is een overzicht gegeven van de verschillende liggerberekeningen die nodig zijn. De afspanliggers en HEB-liggers ter plaatse van aanduiding 3, 6 en 9 zijn ongewijzigd t.o.v. de HA/c-mast. Er wordt een extra controle uitgevoerd vanwege de hogere verticale belasting uit de aflopers naar het OSP.

De onderdelen 1,2,4,5,7 en 8 zijn identiek aan masttype HA+0/ci en worden op dezelfde wijze belast. Voor de berekening van die onderdelen wordt verwezen naar dat masttype. In Figuur 1 en Figuur 2 zijn de liggers weergegeven.

	Voorzijde	Midden	Achterzijde
Liggers 1	Afspanketting	-	Verticale post
Liggers 2	-	Verticale post	-
Liggers 3	Conform HA/c		
Liggers 4	-	-	Horizontale post
Liggers 5	Afspanketting + verticale post	-	-
Liggers 6	Conform HA/c		
Liggers 7	Afspanketting	Verticale afloper	-
Liggers 8	Horizontale post + afloper	-	Horizontale post + afloper
Liggers 9	Conform HA/c		
Liggers 10	Afspanketting (afloper), conform HA/c		

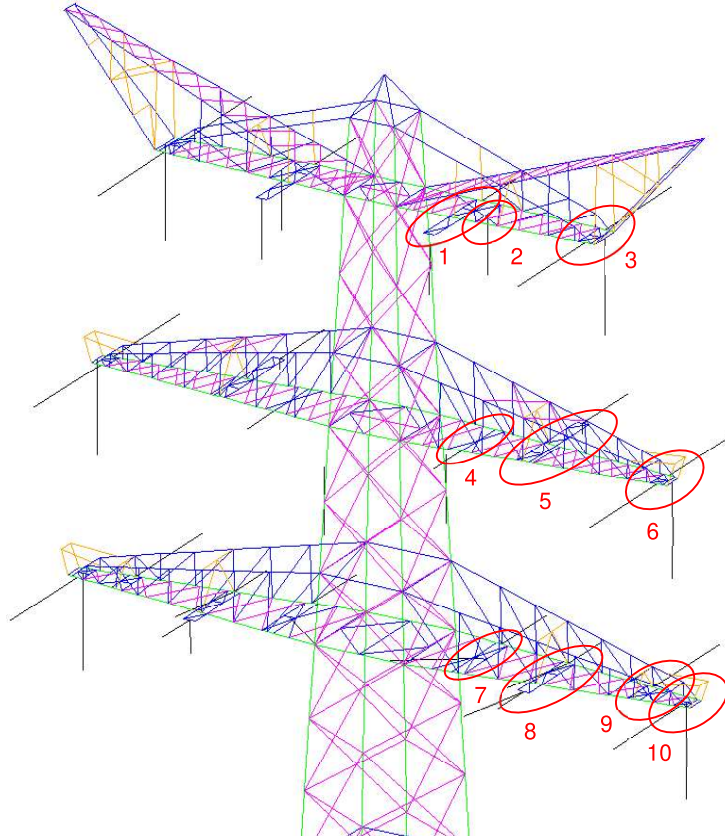

Figuur 1 Overzicht van liggers

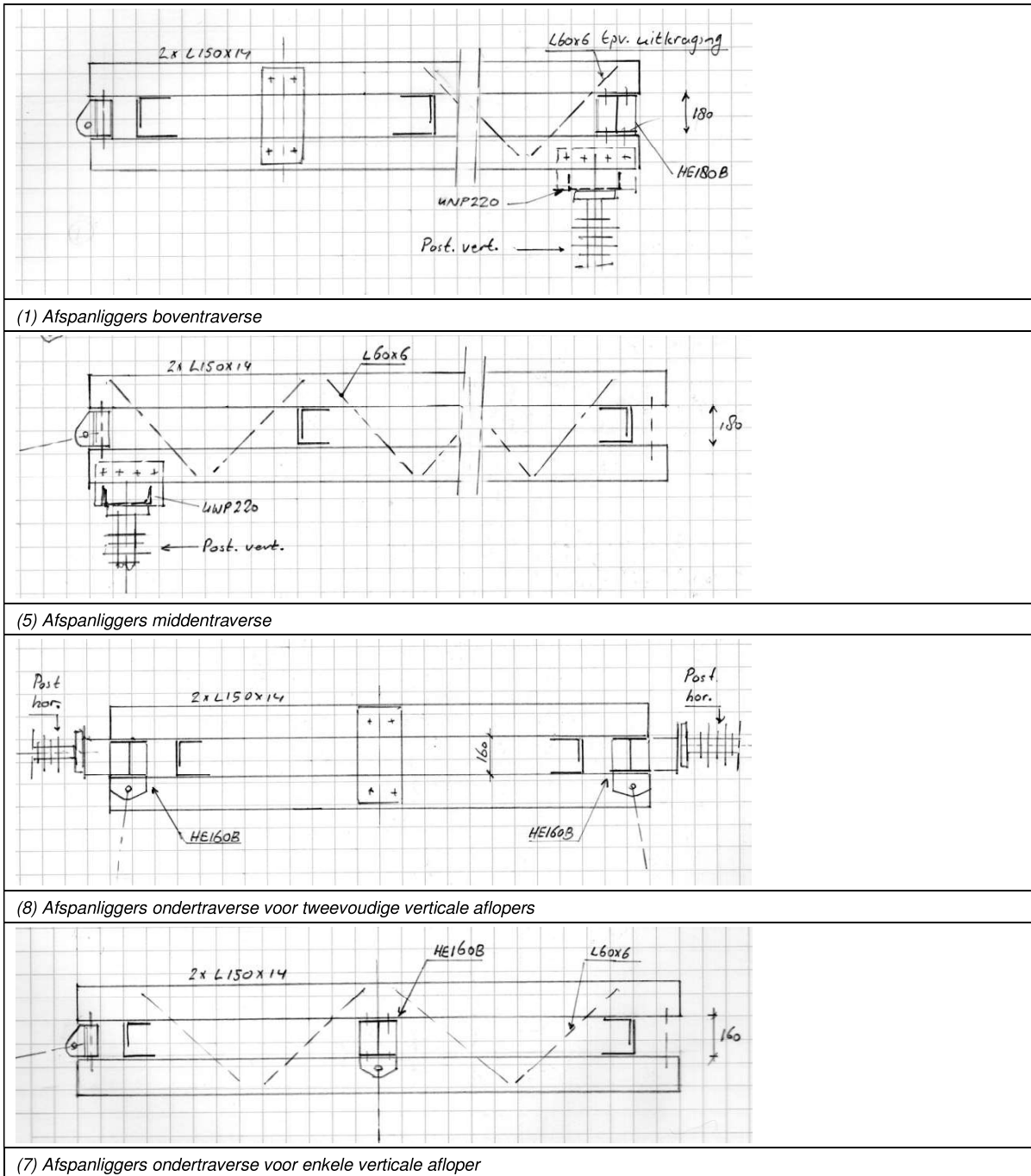

Figuur 2 Principe afspanliggers

Controle van verticale belasting afspanisolatoren

De kortsluitbelasting leidt tot de grootste trekkracht en daarmee ook tot de grootste verticale belasting.

Geleider	w _{z,G} [N/m]	Kortsluitkracht [kN]	F _x [kN]	F _y [kN]	F _z [kN]
10	380ct1f1	80,1	61,4	3,1	51,3
11	380ct1f2	77,0	59,3	5,8	48,8
12	380ct1f3	44,8	34,6	1,8	28,4

In de berekening van de hoekmasten is uitgegaan van een verticale belasting F_z van 44,4 kN. In de tabel zijn de rekenbelastingen opgenomen voor EA-3_co. Ten opzichte van de hoekmasten (wind en ijs maatgevend) is de trekkracht F_x en dwarskracht F_y aanmerkelijk lager.

Tabel 1 Geleiderbelastingen

Belastingcombinatie	Spanning	Fxtotaal	Fytotaal	Fztotaal
ULS 3_120	380 kV	220,0	142,3	44,4
ULS 8	380 kV	61,4	5,8	51,3

De belastingen worden omgezet naar een lijnlast rondom het gat voor de pen. De x- en y-belasting op de helft van de omtrek, de verticale belasting (z-richting) rondom de gehele omtrek.

De belasting van Tabel 1 wordt verdeeld over twee kettingen. Vanwege de steilere afloop wordt circa 50% van de horizontale belasting verdeeld naar de onderste ligger. Verticale belasting gaat geheel naar de onderste ligger.

Tabel 2 Schematisering belasting

	d (mm)	Omtrek bij F _x (mm)	Omtrek bij F _y (mm)	Omtrek bij F _z (mm)
380 kV	32	50,3	50,3	100,5
Verhouding afdracht		0,5	0,5	1

De lijnbelasting wordt berekend met:

$$q = 1/2 \cdot k \cdot F / O$$

In Tabel 3 zijn de lijnlasten berekend met bovenstaande formule. Deze zijn in AxisVM ingevoerd.

Tabel 3 lijnlast rond gat

	q (kN/m)	q (kN/m)	q (kN/m)
380 kV	305	29	255

Toetsing

Zie de uitvoer van AxisVM. De buiging in het bovenvlak van het hoekprofiel ter plaatse van het afspanscharnier is maatgevend.

Lineaire berekening	
Norm:	Eurocode-NL
Geval:	Co #2
E (P):	4,70E-9
E (W):	4,70E-9
E (Eq):	8,40E-11
Comp.:	SVM T (N/mm ²)

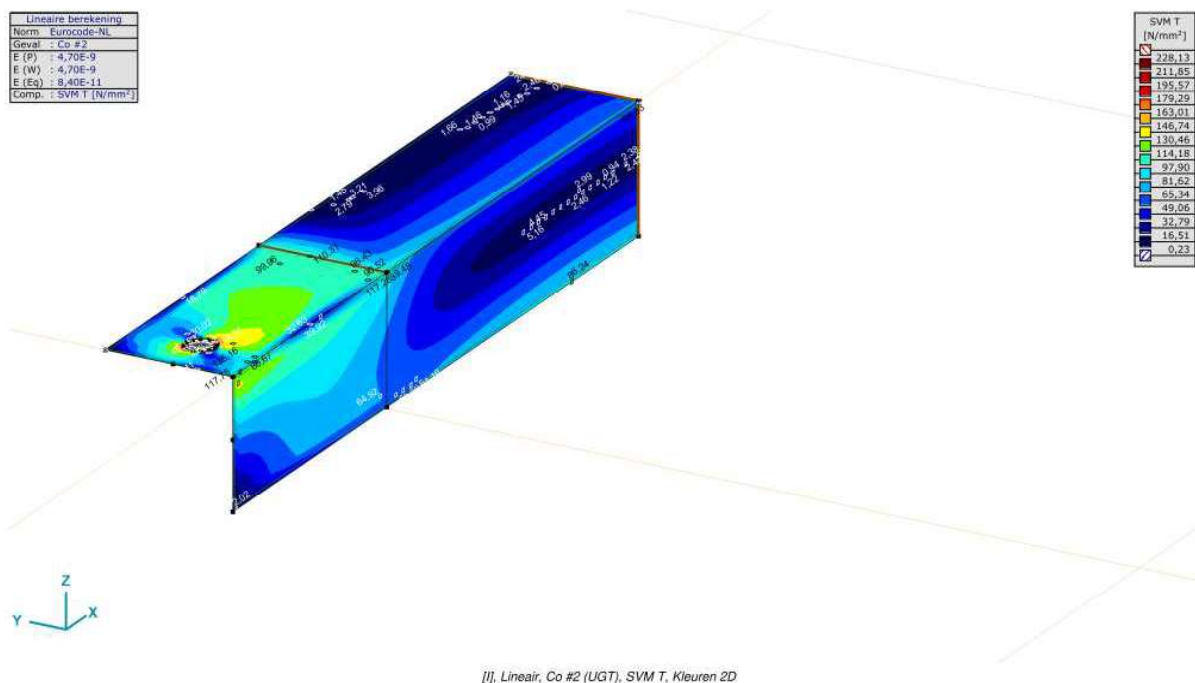

Figuur 3 Maximale spanning in hoekprofiel voor 380 kV

Toetsing:

L150x18: U.C. : $228 / 355 = 0,64 \leq 1,00$ OK

De profielen voldoen.

Project:

Constructeur: DNV GL - Energy

AxisVM X5 R4h • Geregistreerd aan DNV GL - Energy
Liggers EA-3_co.axs

Rapport

Rapport, Inhoudsopgave

	<i>Onderdeel</i>	<i>Pagina</i>	<i>Onderdeel</i>	<i>Pagina</i>
Tekening		3	Gebruiker gedefinieerde belastingcombinaties uit belastinggevallen	10
Tekening2		4	[I], Linear, Co #1 (UGT), SVM T, Kleuren 2D	11
Materialen		5	[I], Linear, Co #2 (UGT), SVM T, Kleuren 2D	12
Domeinen		5	[I], Linear, Co #1 (UGT), SVM C, Kleuren 2D	13
Lijnopleggingen		5	[I], Linear, Co #2 (UGT), SVM C, Kleuren 2D	14
Fx		6	[I], Linear, Co #1 (UGT), eY, Lijnen	15
Fx: Oppervlak lijnlast		7	[I], Linear, Co #2 (UGT), eY, Lijnen	16
Fy1		7	[I], Linear, Co #1 (UGT), eZ, Lijnen	17
Fy1: Oppervlak lijnlast		8	[I], Linear, Co #2 (UGT), eZ, Lijnen	18
Fy2		8	[I], Linear, Co #1 (UGT), Ry (lijnopp.), Doorsnedelijn	19
Fy2: Oppervlak lijnlast		9	[I], Linear, Co #2 (UGT), Ry (lijnopp.), Doorsnedelijn	20
Fz		9	[I], Linear, Co #1 (UGT), Rz (lijnopp.), Doorsnedelijn	21
Fz: Oppervlak lijnlast		10	[I], Linear, Co #2 (UGT), Rz (lijnopp.), Doorsnedelijn	22

Project:

Constructeur: DNV GL - Energy

Model: **Liggers EA-3_co.axs**

1-7-2021

Pag. 3

Norm Eurocode-NL

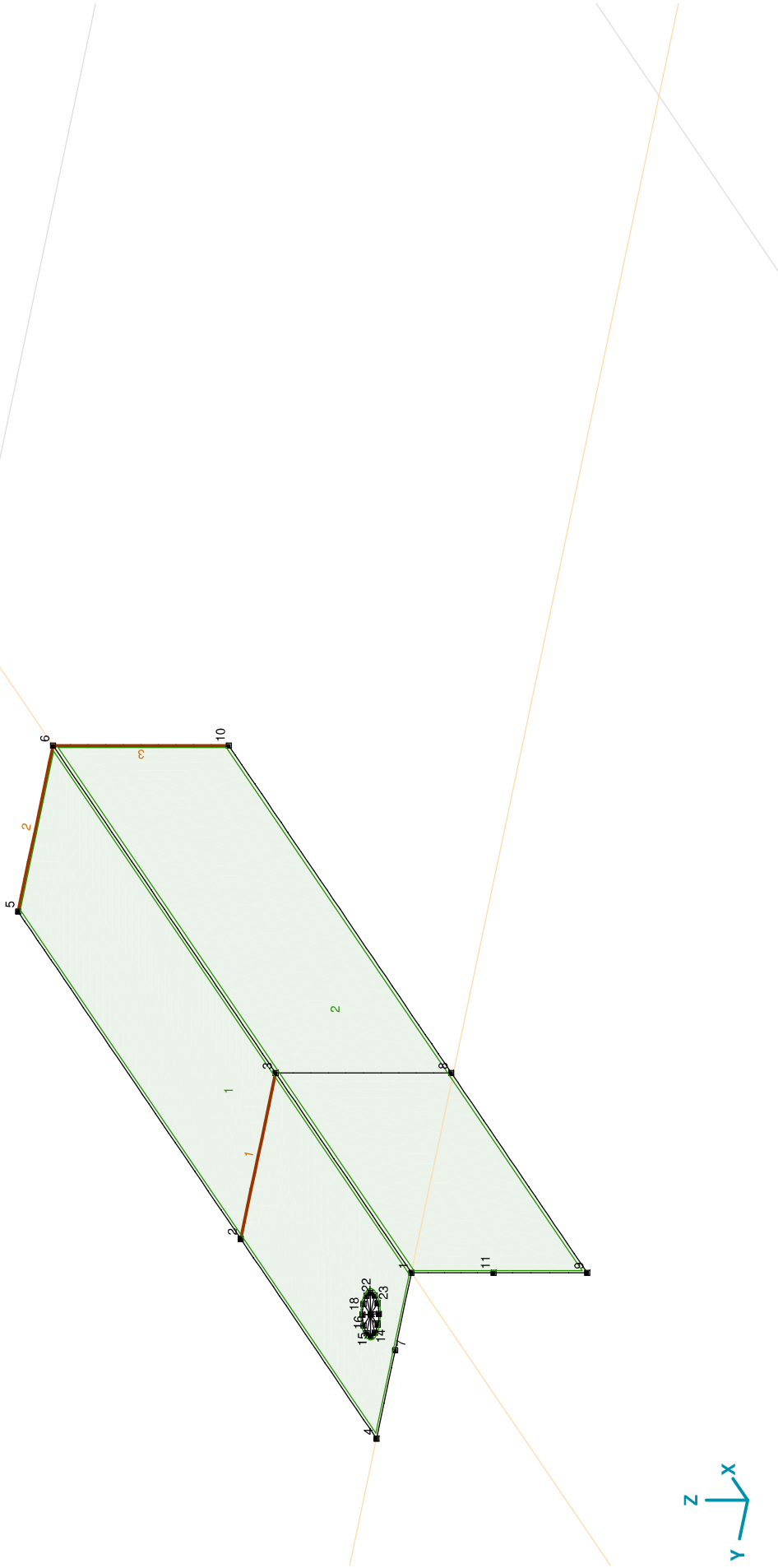

Tekening

Project:

Constructeur: DNV GL - Energy
Model: **Liggers EA-3_co.axs**

1-7-2021

Pag. 4

Norm Eurocode-NL

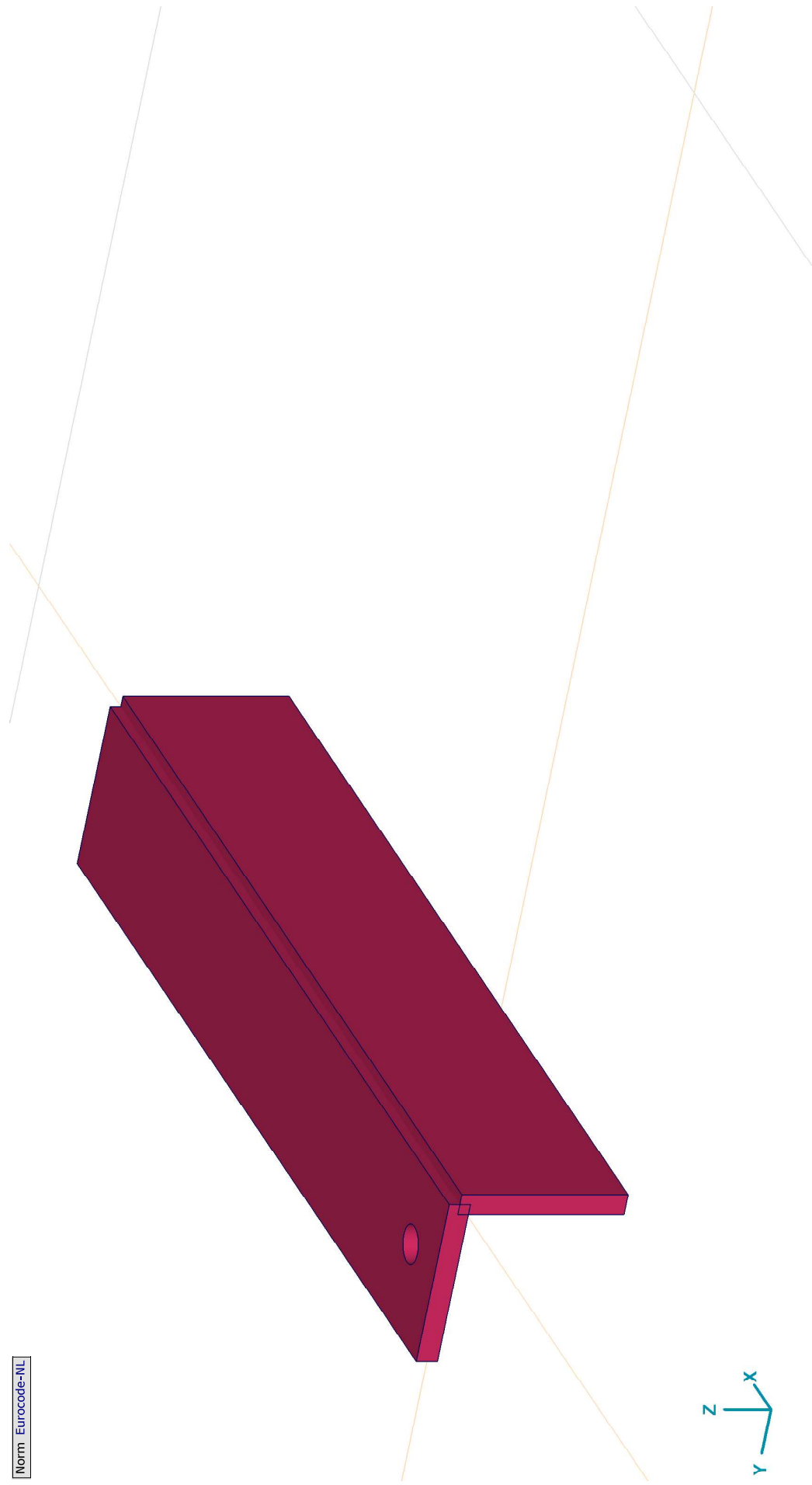

Tekening2

Project:

Constructeur: DNV GL - Energy

Model: **Liggers EA-3_co.axs**

1-7-2021

Pag. 5

Materialen

Naam	Type	Nationale norm	Materiaalnorm	Model	E_x [N/mm ²]	E_y [N/mm ²]	ν	α_T [1/°C]	ρ [kg/m ³]	Materiaal kleur	Contour kleur	Structuur	P_1
1	S 355	Staal	Eurocode-NL 10025-2	Lineair	210000	210000	0.30	1,2E-5	7850				f_{t0} [N/mm ²] = 355.00

Naam	P_2	P_3	P_4	P_5	P_6	P_7	P_8	P_9	P_{10}	P_{11}	P_{12}	P_{13}	P_{14}
1	S 355	f_{t0} [N/mm ²] = 510.00	f_{t0} [N/mm ²] = 335.00	f_{t0} [N/mm ²] = 470.00									

Naam: Materiaalnaam; **Type:** Type materiaal; **Model:** Materiaal model; **E_x :** Elasticiteitsmodulus in lokale x richting; **E_y :** Elasticiteitsmodulus in lokale y richting; **ν :** Poisson's verhouding; **α_T :** Warmteuitzettingscoëfficiënt; **ρ :** Dichtheid; **Materiaal kleur:** Materiaalkleur; **Contour kleur:** Contourkleur; **P_1 , P_2 , P_3 , P_4 , P_5 , P_6 , P_7 , P_8 , P_9 , P_{10} , P_{11} , P_{12} , P_{13} , P_{14} :** Ontwerpparameters;

Domeinen

Element type	Materiaal	Ref_x	Ref_z	Dikte [mm]	$k_{buiging}$ [I]	k_{torsie} [I]	$k_{afschuiving}$ [I]	Oppervlakte [m ²]	Gat	Mesh
1	S 355	Auto	Auto	18				0,113	1	✓
2	S 355	Auto	Auto	18				0,114	-	✓

Element type: Plaat element type; **Ref_x :** Referentie voor lokale X-richting; **Ref_z :** Referentie voor lokale Z-richting; **$k_{buiging}$:** Buigsterkte coefficient; **k_{torsie} :** Torsiesterke coefficient; **$k_{afschuiving}$:** Dwarskrachsterke coefficient; **Oppervlakte:** Domein oppervlakte; **Gat:** Aantal gaten in domein; **Mesh:** Gegeneerde mesh;

Lijnopleggingen

Lijn	Type	Ref_{elem}	R_x [kN/m/m]	R_y [kN/m/m]	R_z [kN/m/m]	R_{xx} [kNm/rad/m]	R_{yy} [kNm/rad/m]	R_{zz} [kNm/rad/m]	$NL(x)$	$NL(y)$	$NL(z)$
1	Rand (2010)	Glob.	0	1E+7	1E+7	0	0	0	Symmetrisch	Symmetrisch	Symmetrisch
2	Rand (1935)	Glob.	1E+10	0	0	0	0	0	Symmetrisch		
3	Rand (80)	Glob.	1E+10	0	0	0	0	0	Symmetrisch		

Lijn	$NL(xx)$	$NL(yy)$	$NL(zz)$	$F(x)$ [kN/m]	$F(y)$ [kN/m]	$F(z)$ [kN/m]	$M(x)$ [kNm/m]	$M(y)$ [kNm/m]	$M(z)$ [kNm/m]
1	Rand (2010)								
2	Rand (1935)								
3	Rand (80)								

Lijn: Ondersteund lijnelement; **Type:** Opleggingstype; **Ref_{elem} :** Referentie-element; **R_x , R_y , R_z :** Verplaatsingsstijfheid; **R_{xx} , R_{yy} , R_{zz} :** Rotatiestijfheid; **$NL(x)$, $NL(y)$, $NL(z)$, $NL(xx)$, $NL(yy)$, $NL(zz)$:** Niet-lineaire parameters; **$F(x)$:** Weerstand in X-richting; **$F(y)$:** Weerstand in Y-richting; **$F(z)$:** Weerstand in Z-richting; **$M(x)$:** Weerstandsmoment in X-richting; **$M(y)$:** Weerstandsmoment in Y-richting; **$M(z)$:** Weerstandsmoment in Z-richting;

Project:

Constructeur: DNV GL - Energy

Model: **Liggers EA-3_co.axs**

1-7-2021

Pag. 6

Norm: Eurocode-NL
Geval: Fx

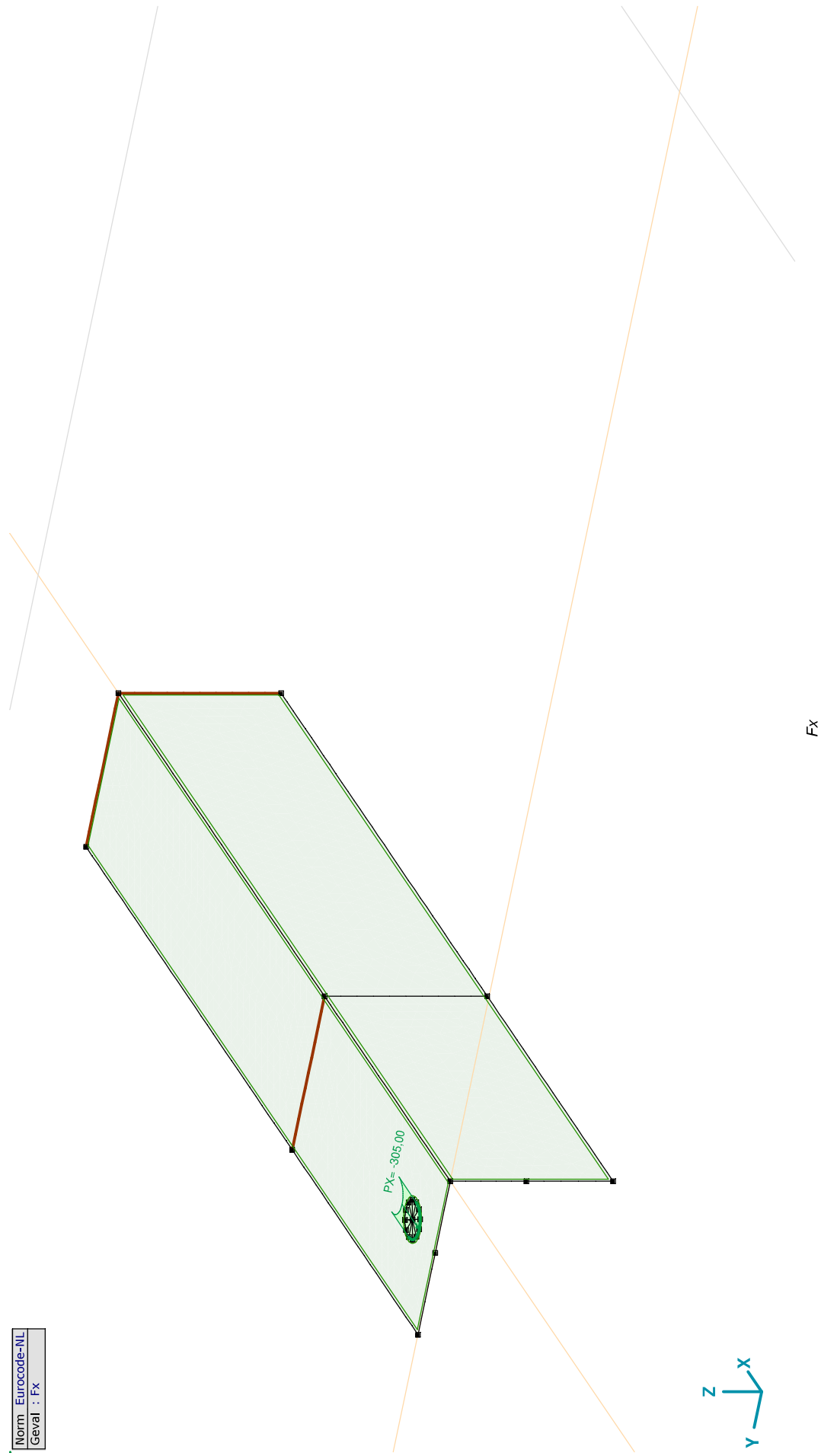

Project:

Constructeur: DNV GL - Energy

Model: **Liggers EA-3_co.axs**

Fx: Oppervlak lijnlast

	Richting	p_x [kN/m]	p_y [kN/m]	p_z [kN/m]	p_m [kNm/m]	X [m]	Y [m]	Z [m]	Richting	dL [m]
1	Global	-305,00	0	0	0	0,055	0,082	0	(0,055; 0,066; 0,000)	0
		-305,00	0	0	0	0,055	0,050	0	-	0,050

px, py, pz: Belastingkracht component; **pm:** Belastingmoment component; **X:** Belasting in X-richting; **Y:** Belasting in Y-richting; **Z:** Belasting in Z-richting;

Norm Eurocode-NL
Geval : Fy1

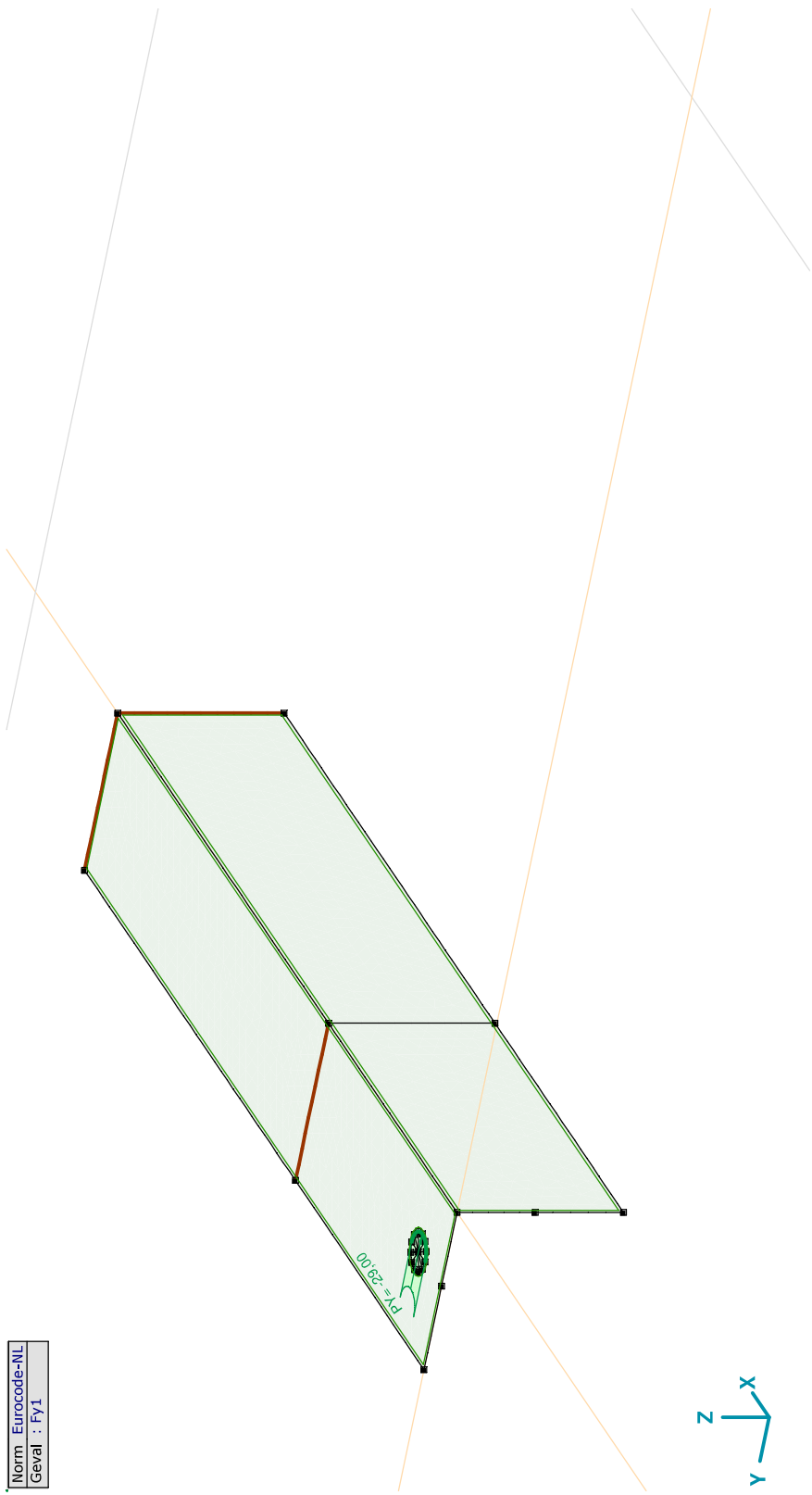

Fy1

Project:

Constructeur: DNV GL - Energy

Model: **Liggers EA-3_co.axs**

Fy1 : Oppervlak lijnlast

	Richting	p_x [kN/m]	p_y [kN/m]	p_z [kN/m]	p_m [kNm/m]	X [m]	Y [m]	Z [m]	Richting	dL [m]
3	Global	0	-29,00	0	0	0,071	0,066	0	(0,055; 0,066; 0,000)	0
		0	-29,00	0	0	0,039	0,066	0	-	0,050

px, py, pz: Belastingkracht component; **pm:** Belastingmoment component; **X:** Belasting in X-richting; **Y:** Belasting in Y-richting; **Z:** Belasting in Z-richting;

Norm Eurocode-NL
Geval : Fy2

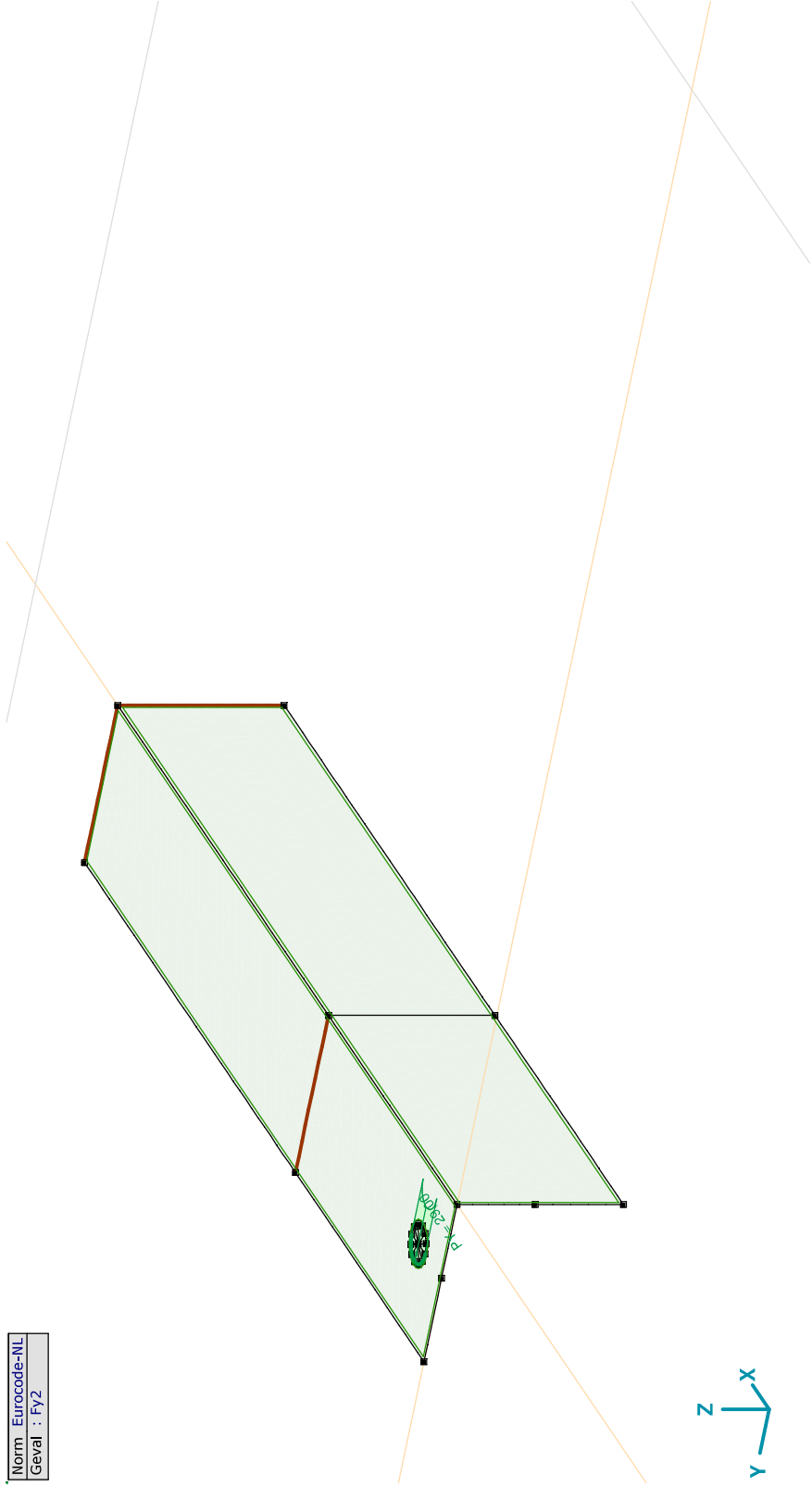

Fy2

Project:

Constructeur: DNV GL - Energy

Model: **Liggers EA-3_co.axs**

Fy2: Oppervlak lijnlast

	Richting	p_x [kN/m]	p_y [kN/m]	p_z [kN/m]	p_m [kNm/m]	X [m]	Y [m]	Z [m]	Richting	dL [m]
4	Global	0	29,00	0	0	0,071	0,066	0	(0,055; 0,066; 0,000)	0
		0	29,00	0	0	0,039	0,066	0	-	0,050

px, py, pz: Belastingkracht component; **pm:** Belastingmoment component; **X:** Belasting in X-richting; **Y:** Belasting in Y-richting; **Z:** Belasting in Z-richting;

Norm	Eurocode-NL
Geval	Fz

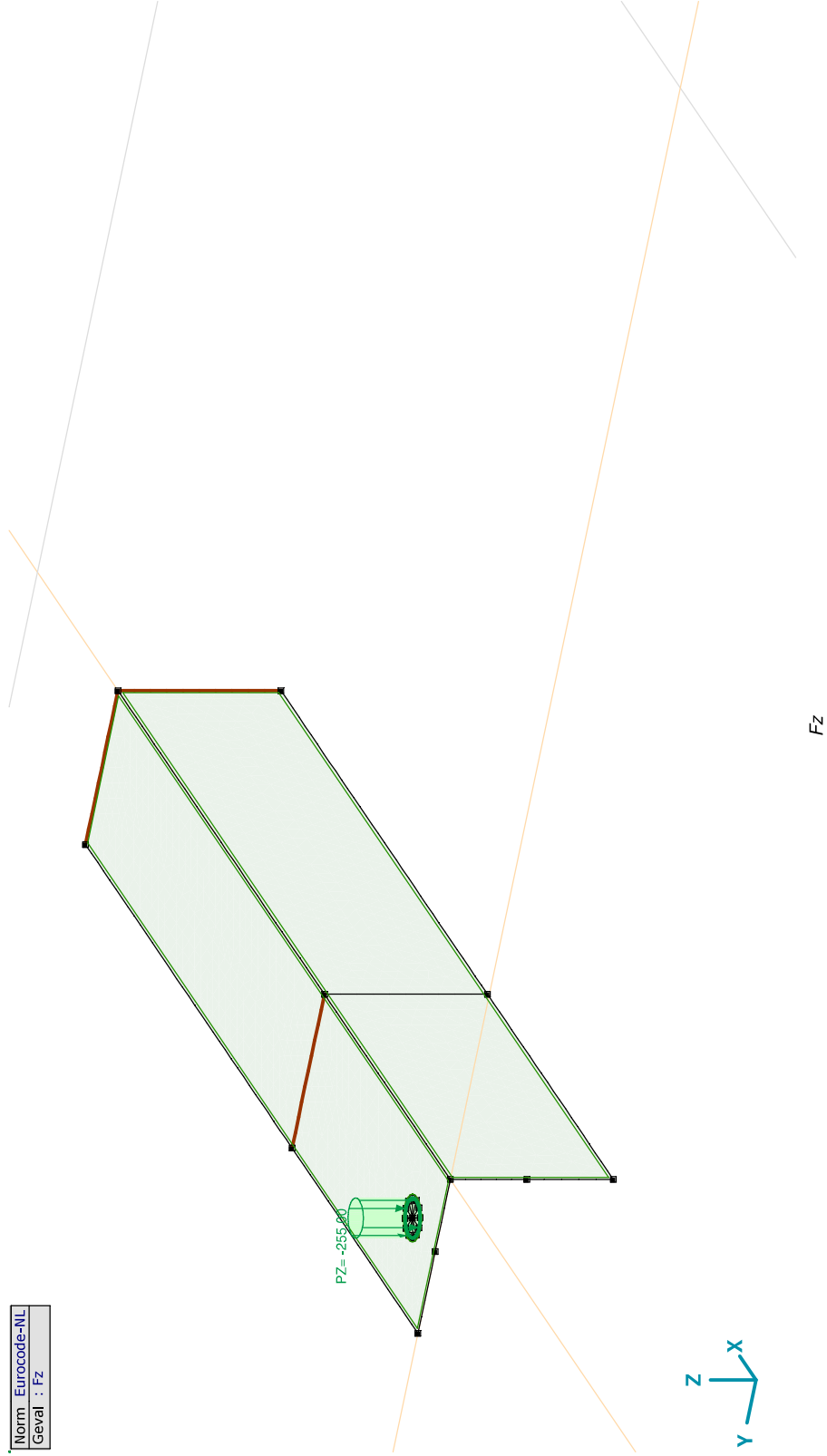

Project:

Constructeur: DNV GL - Energy

Model: **Liggers EA-3_co.axs**

1-7-2021

Pag. 10

Fz: Oppervlak lijnlast

	Richting	p_x [kN/m]	p_y [kN/m]	p_z [kN/m]	p_m [kNm/m]	X [m]	Y [m]	Z [m]	Richting	dL [m]
2	Global	0	0	-255,00	0	0,071	0,066	0	(0,055; 0,066; 0,000)	0
		0	0	-255,00	0	0,071	0,066	0	-	0,101

p_x, p_y, p_z : Belastingkracht component; p_m : Belastingmoment component; **X**: Belasting in X-richting; **Y**: Belasting in Y-richting; **Z**: Belasting in Z-richting;

Gebruiker gedefinieerde belastingcombinaties uit belastinggevallen

	Naam	Type	F_x	F_{y1}	F_{y2}	F_z	Commentaar
1	Co #1	UGT	1,00	1,00	0	1,00	
2	Co #2	UGT	1,00	0	1,00	1,00	

Naam: Naam belastingcombinatie; **Type**: Type belastingcombinatie; **F_x**, **F_{y1}**, **F_{y2}**, **F_z**: Factor;

Project:

Constructeur: DNV GL - Energy
 Model: **Liggers EA-3_co.axs**

Lineaire berekening
Norm Eurocode-NL
Geval : Co. #1
E (P) : 4,70E-9
E (W) : 4,70E-9
E (Eq) : 8,40E-11
Comp. : SVM T [N/mm ²]

SVM T	[N/mm ²]
[Red]	226,11
[Dark Red]	209,98
[Red-Orange]	193,85
[Orange]	177,72
[Light Orange]	161,59
[Yellow-Orange]	145,46
[Yellow]	129,33
[Light Green]	113,20
[Green]	97,07
[Light Blue]	80,94
[Blue]	64,81
[Dark Blue]	48,68
[Very Dark Blue]	32,55
[Darkest Blue]	16,42
[White]	0,29

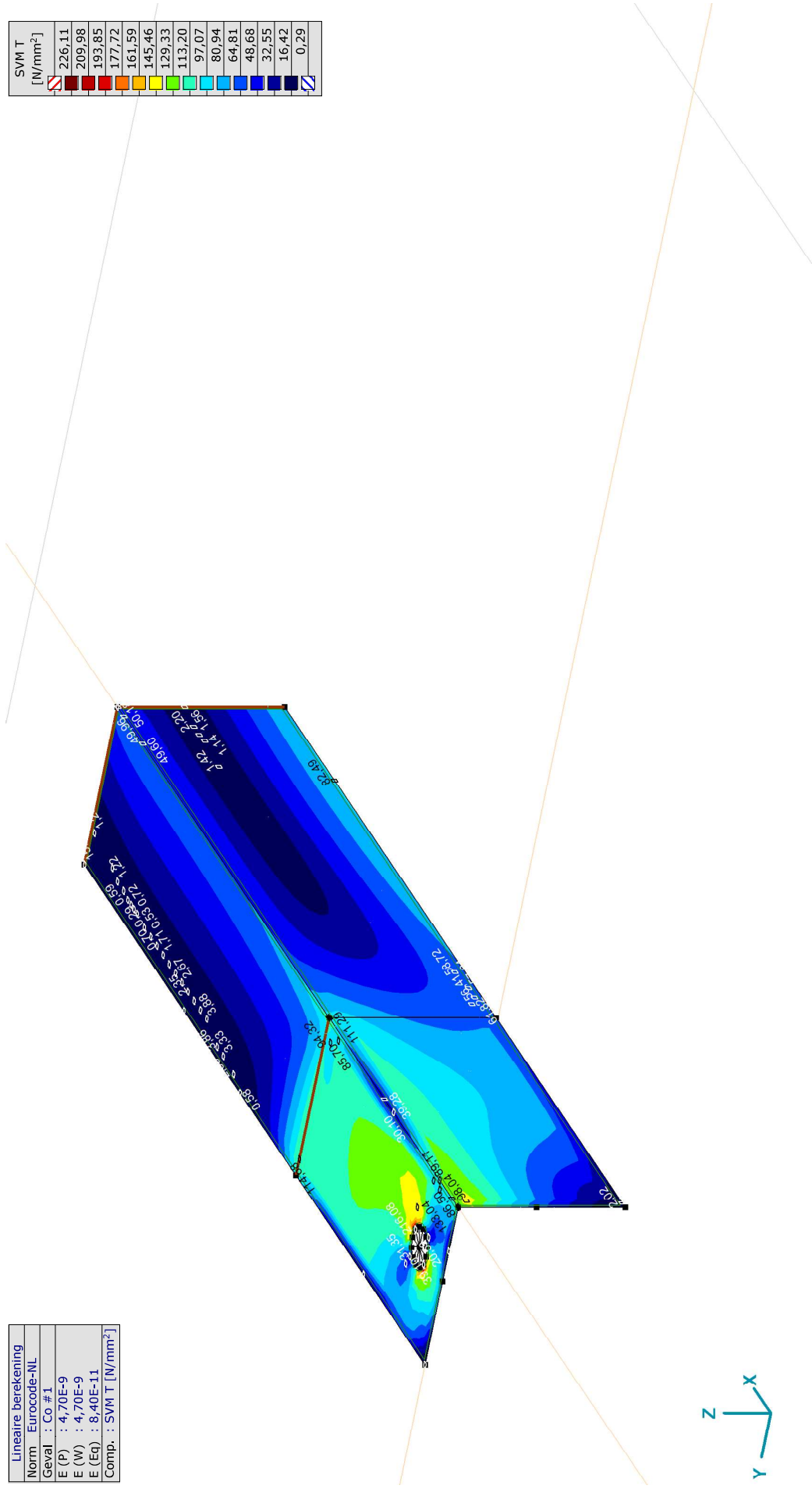

[I], Lineair, Co #1 (UGT), SVM T, Kleuren 2D

Project:

Constructeur: DNV GL - Energy
 Model: Liggers EA-3_co.axs

Lineaire berekening
Norm Eurocode-NL
Geval : Co.#2
E (P) : 4,70E-9
E (W) : 4,70E-9
E (Eq) : 8,40E-11
Comp. : SVM T [N/mm ²]

SVM T	[N/mm ²]
	228,13
	211,85
	195,57
	179,29
	163,01
	146,74
	130,46
	114,18
	97,90
	81,62
	65,34
	49,06
	32,79
	16,51
	0,23

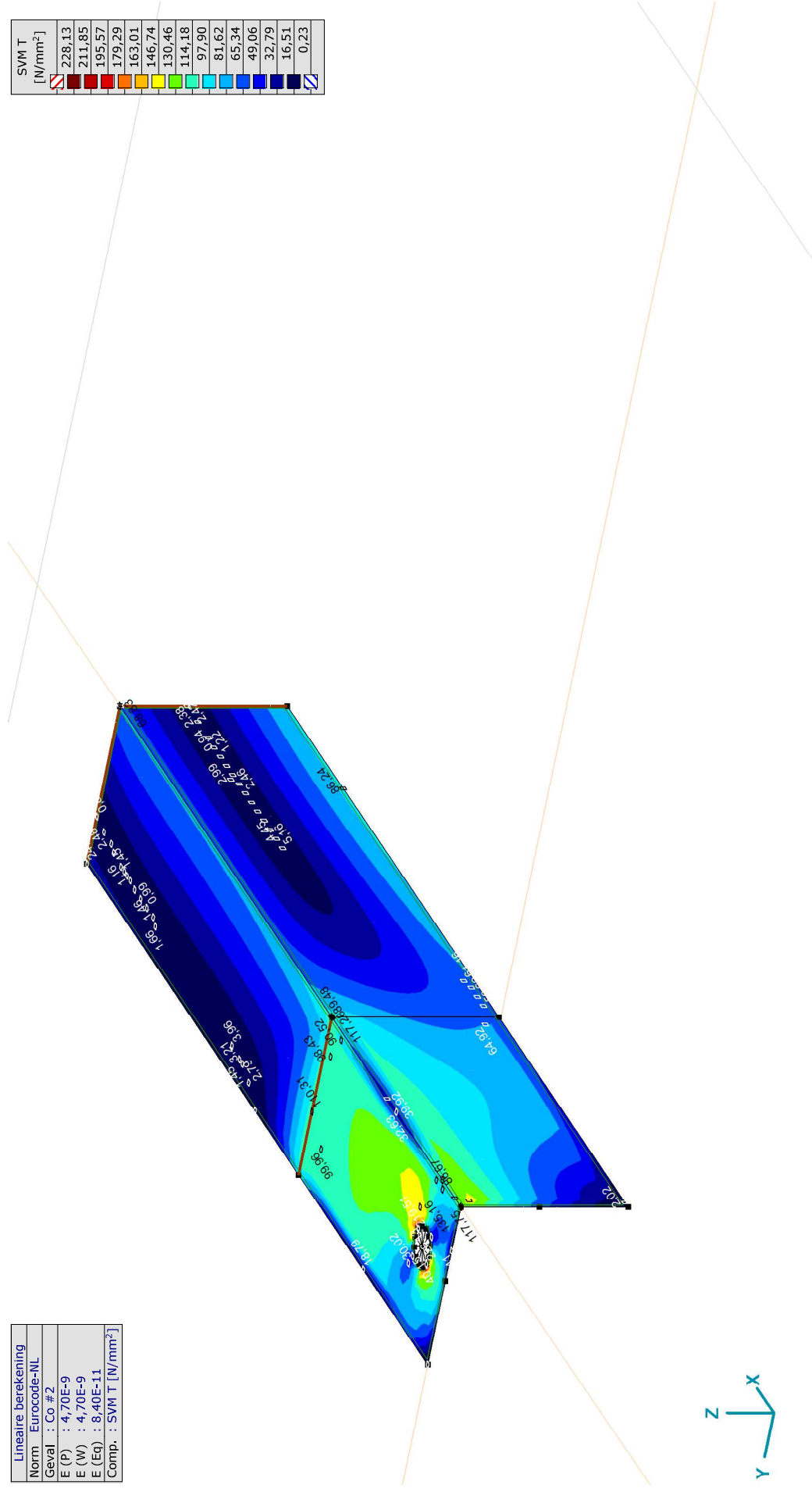

[I], Lineair, Co #2 (UGT), SVM T, Kleuren 2D

Project:

Constructeur: DNV GL - Energy
 Model: Liggers EA-3_co.axs

Lineaire berekening
Norm Eurocode-NL
Geval : Co. #1
E (P) : 4,70E-9
E (W) : 4,70E-9
E (Eq) : 8,40E-11
Comp. : SVM C [N/mm ²]

SVM C	[N/mm ²]
	106,33
	98,76
	91,20
	83,63
	76,06
	68,50
	60,93
	53,36
	45,79
	38,23
	30,66
	23,09
	15,53
	7,96
	0,39

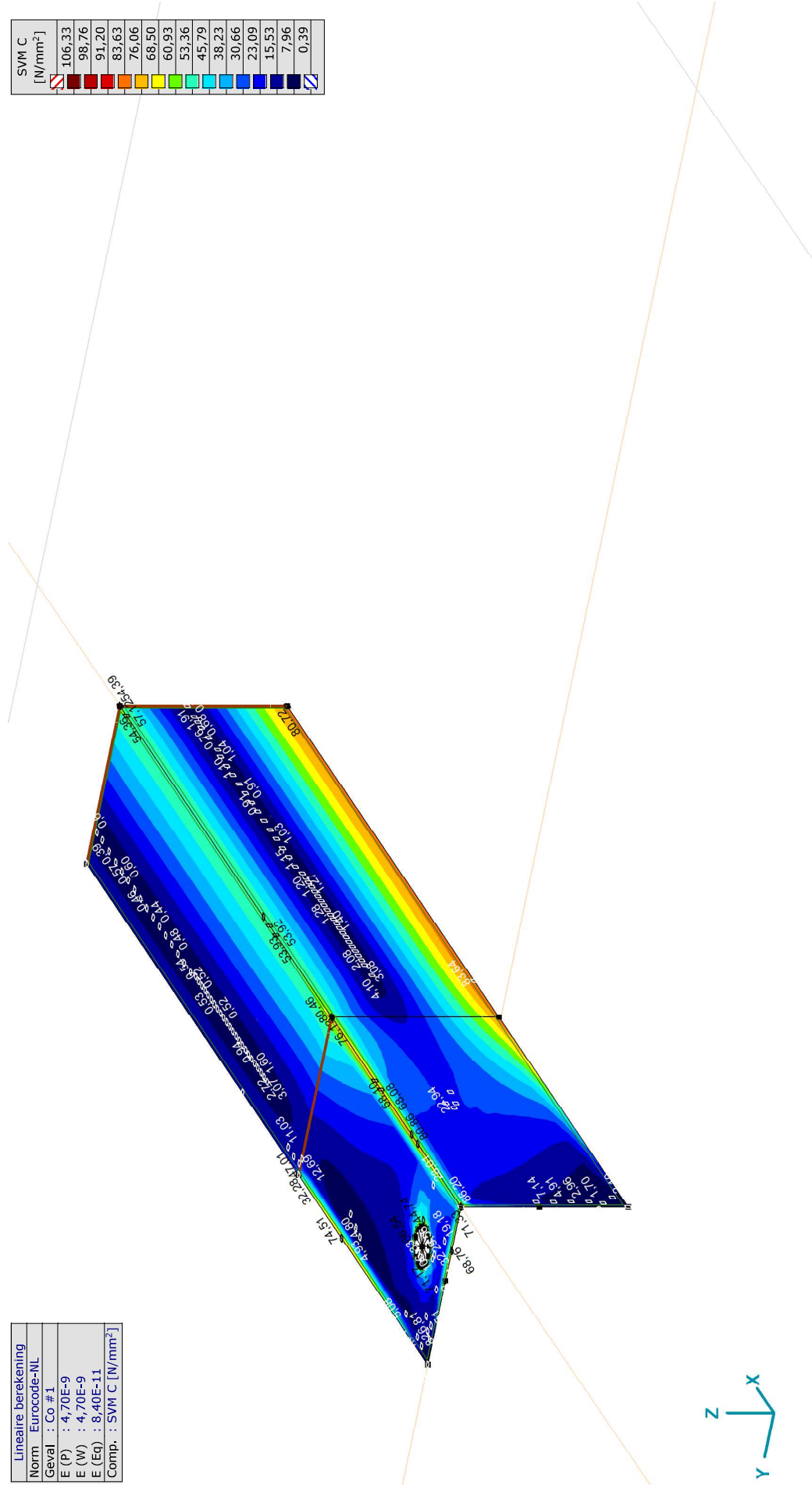

III, Lineair, Co #1 (JGT), SVM C, Kleuren 2D

Project:

Constructeur: DNV GL - Energy

Model: **Liggers EA-3_co.axs**

1-7-2021

Pag. 14

Lineaire berekening
Norm Eurocode-NL
Geval : Co.#2
E (P) : 4,70E-9
E (W) : 4,70E-9
E (Eq) : 8,40E-11
Comp. : SVM C [N/mm ²]

SVM C [N/mm ²]
106,26
98,70
91,14
83,58
76,02
68,46
60,90
53,34
45,78
38,22
30,66
23,10
15,54
7,98
0,42

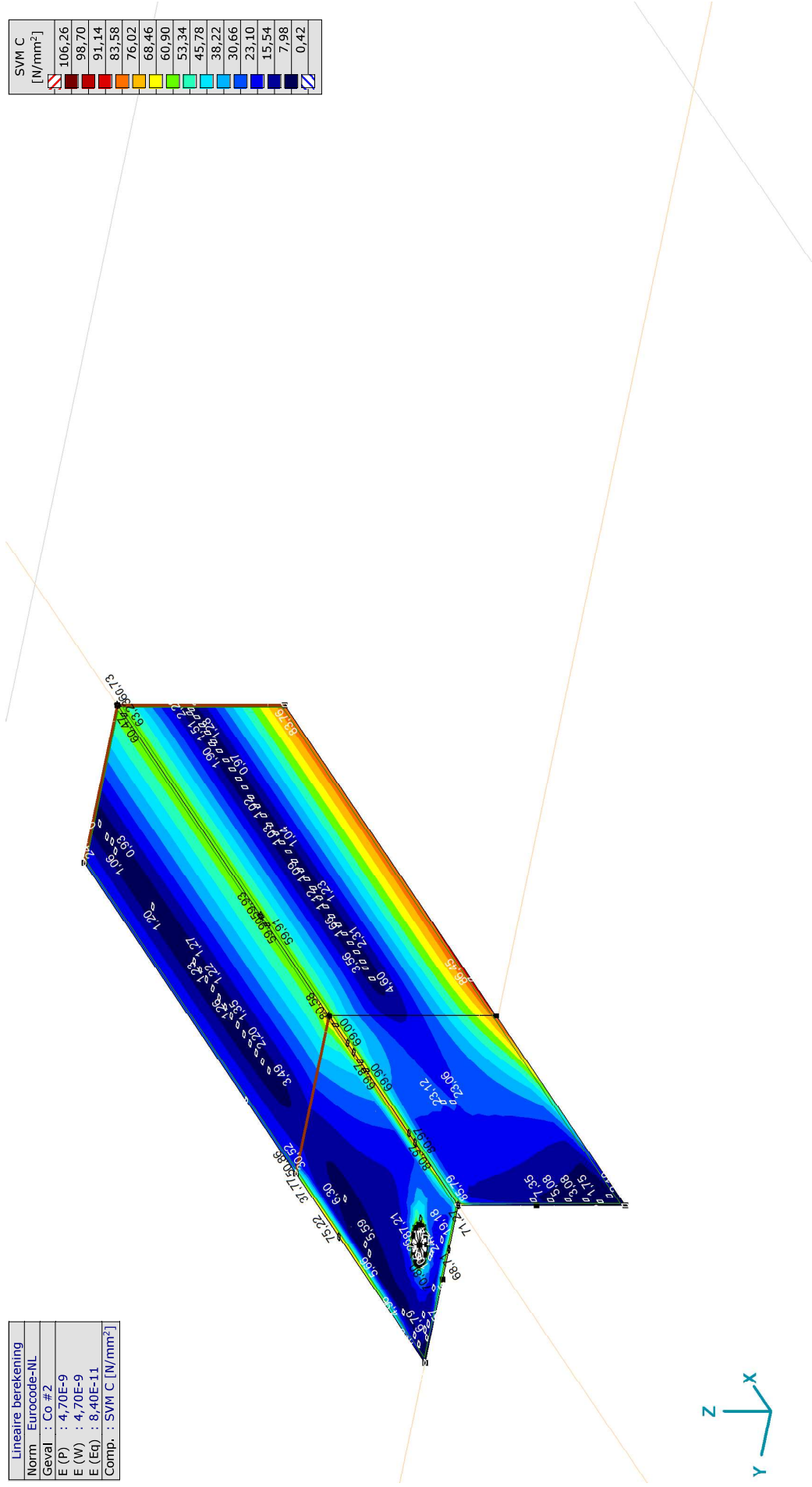

III, Lineair, Co #2 (JGT), SVM C, Kleuren 2D

Project:

Constructeur: DNV GL - Energy

Model: **Liggers EA-3_co.axs**

1-7-2021

Pag. 15

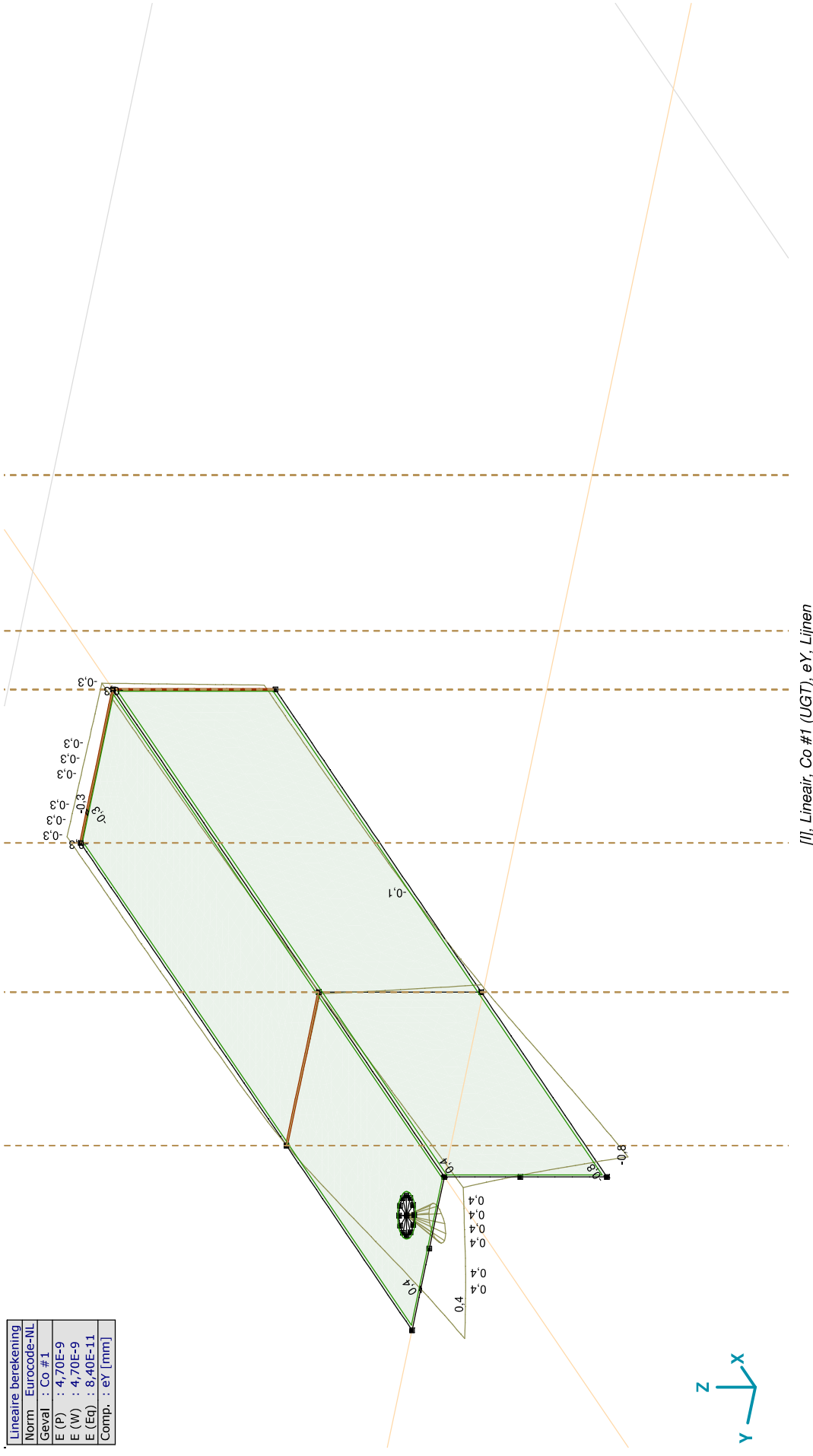

Lineaire berekening	Norm	Eurocode-NL
Geval	: Co_#1	
E (P)	: 4,70E-9	
E (W)	: 4,70E-9	
E (Eq)	: 8,40E-11	
Comp.	: eY [mm]	

Project:

Constructeur: DNV GL - Energy

Model: **Liggers EA-3_co.axs**

1-7-2021

Pag. 16

Lineaire berekening
Norm Eurocode-NL
Geval : Co.#2
E (P) : 4,70E-9
E (W) : 4,70E-9
E (Eq) : 8,40E-11
Comp. : eY [mm]

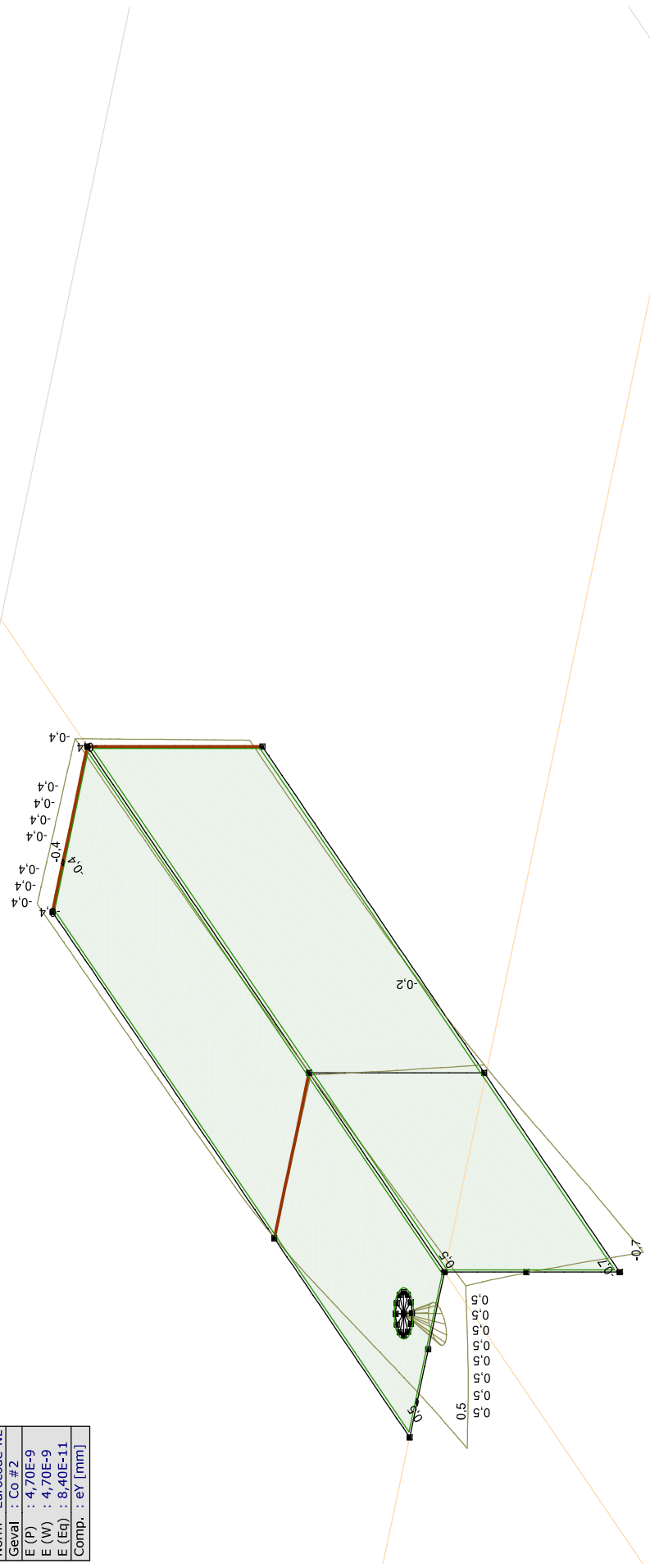

[1]. Lineair, Co #2 (UGT), eY, Lijnen

Project:

Constructeur: DNV GL - Energy

Model: **Liggers EA-3_co.axs**

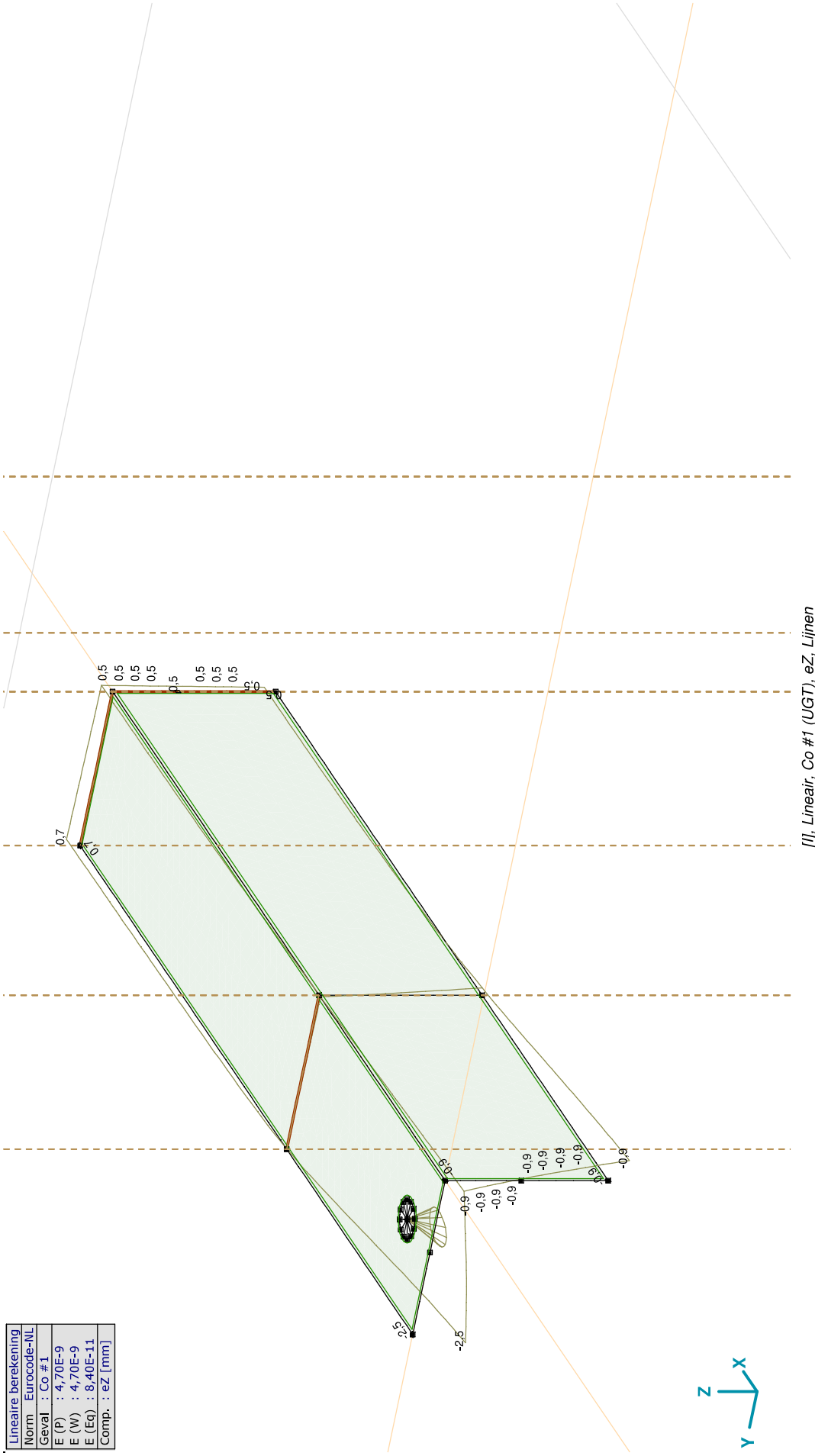

Project:

Constructeur: DNV GL - Energy

Model: **Liggers EA-3_co.axs**

1-7-2021

Pag. 18

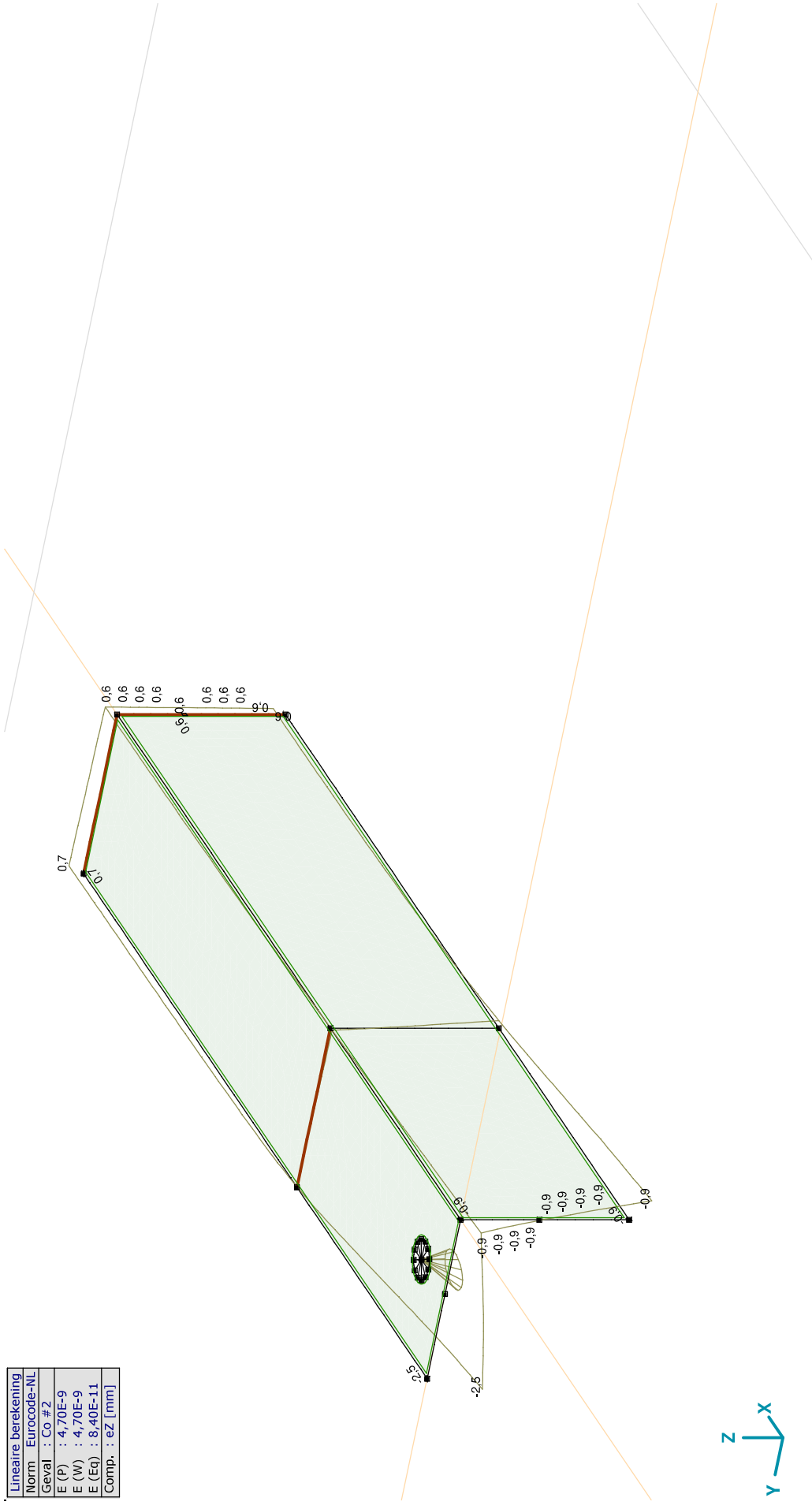

Lineaire berekening	Norm	Eurocode-NL
Geval	: Co.#2	
E (P)	: 4,70E-9	
E (W)	: 4,70E-9	
E (Eq)	: 8,40E-11	
Comp.	: eZ [mm]	

[1]. Lineair, Co #2 (UGT), eZ, Lijnen

Project:

Constructeur: DNV GL - Energy

Model: **Liggers EA-3_co.axs**

1-7-2021

Pag. 19

Lineaire berekening
Norm Eurocode-NL
Geval : Co_#1
E (P) : 4,70E-9
E (W) : 4,70E-9
E (Eq) : 8,40E-11
Comp. : Ry [kN/m]

Ry	[kN/m]
	10,6
	8,6
	6,6
	4,7
	2,7
	0,7
	-1,2
	-3,2
	-5,2
	-7,1
	-9,1
	-11,1
	-13,0
	-15,0
	-17,0

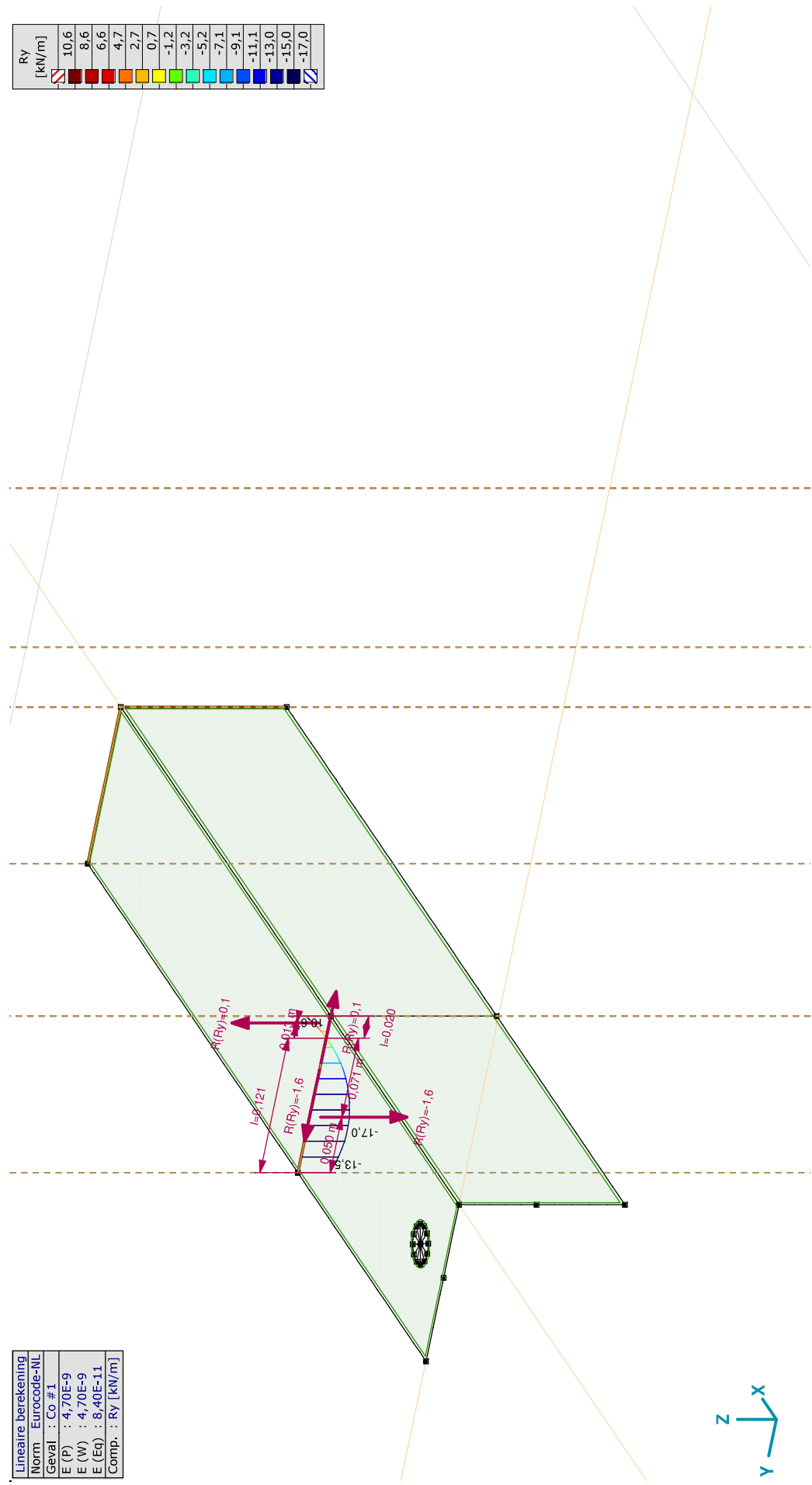

[I], Lineair, Co #1 (UGT), Ry (lijnopp.), Doorsnedelijn



Project:

Constructeur: DNV GL - Energy

Model: **Liggers EA-3_co.axs**

1-7-2021

Pag. 20

Lineaire berekening
Norm Eurocode-NL
Geval : Co. #2
E (P) : 4,70E-9
E (W) : 4,70E-9
E (Eq) : 8,40E-11
Comp. : Ry [kN/m]

Ry	[kN/m]
32,7	
30,4	
28,1	
25,7	
23,4	
21,0	
18,7	
16,4	
14,0	
11,7	
9,4	
7,0	
4,7	
2,3	
0	

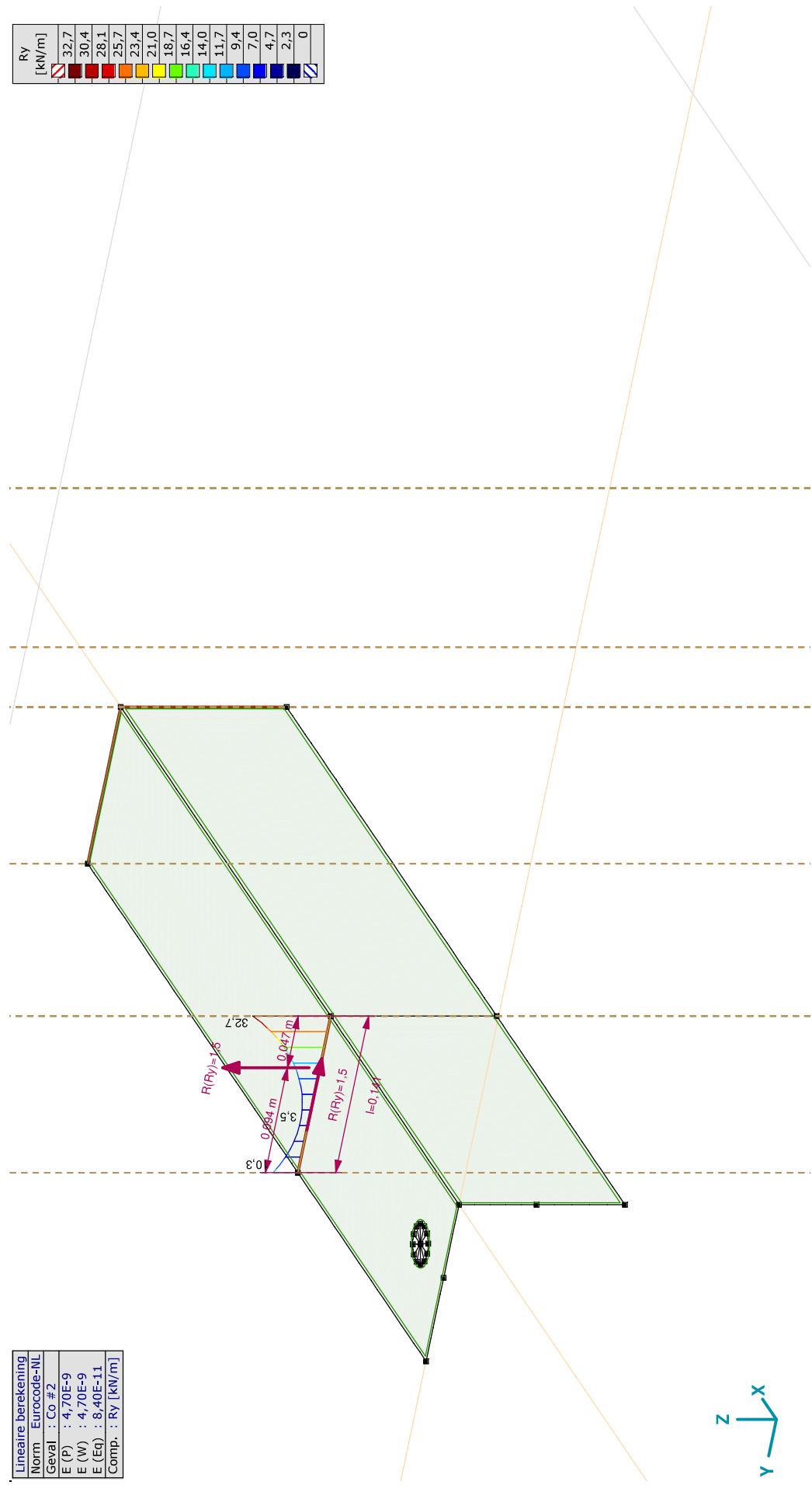

[I], Lineair, Co #2 (UGT), Ry (lijnopp.), Doorsnedelij

Project:

Constructeur: DNV GL - Energy
 Model: **Liggers EA-3_co.axs**

1-7-2021

Pag. 21

Lineaire berekening
Norm Eurocode-NL
Geval : Co. #1
E (P) : 4,70E-9
E (W) : 4,70E-9
E (Eq) : 8,40E-11
Comp. : Rz [kN/m]

Rz [kN/m]	0
	-15,3
	-30,6
	-45,9
	-61,2
	-76,5
	-91,8
	-107,1
	-122,4
	-137,7
	-153,0
	-168,4
	-183,7
	-199,0
	-214,3

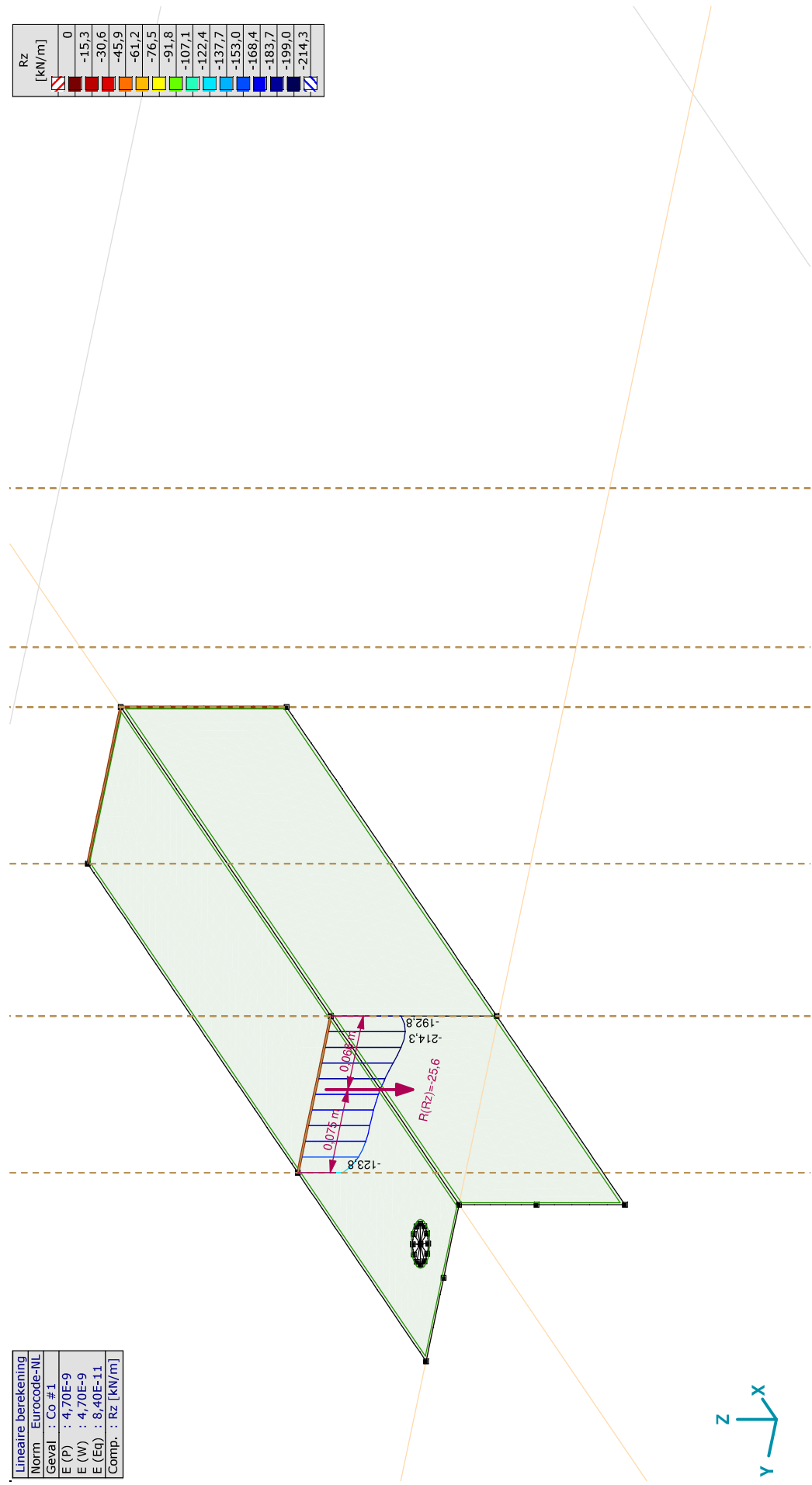

[[], Linear, Co #1 (UGT), Rz (lijnopp.), Doorsnedelijn



Project:

Constructeur: DNV GL - Energy
 Model: **Liggers EA-3_co.axs**

1-7-2021

Pag. 22

Lineaire berekening
Norm Eurocode-NL
Geval : Co #2
E (P) : 4,70E-9
E (W) : 4,70E-9
E (Eq) : 8,40E-11
Comp. : Rz [kN/m]

Rz [kN/m]	0
	-15,3
	-30,6
	-45,9
	-61,2
	-76,5
	-91,7
	-107,0
	-122,3
	-137,6
	-152,9
	-168,2
	-183,5
	-198,8
	-214,1

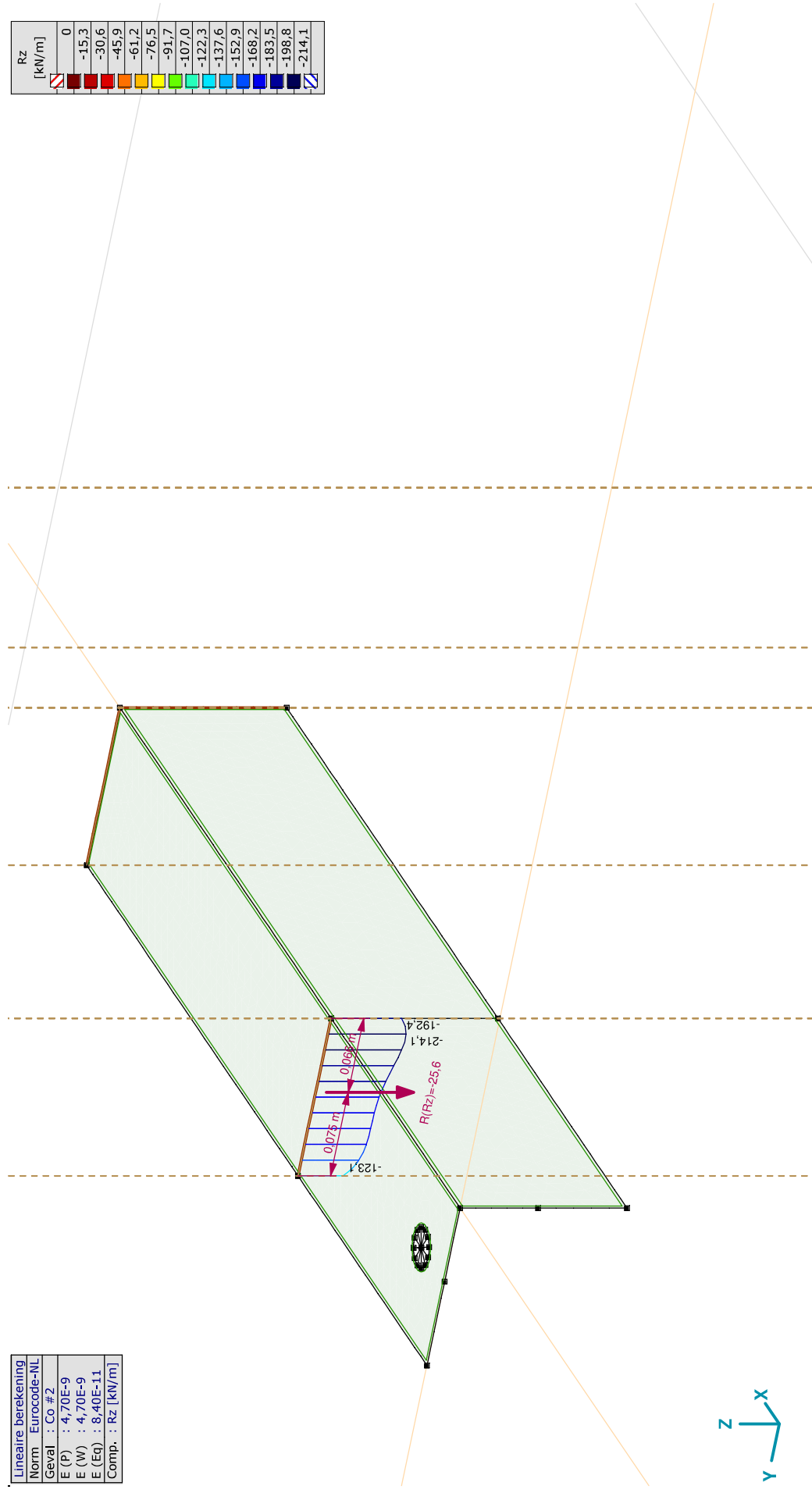

[[], Linear, Co #2 (UGT), Rz (lijnop.), Doorsnedelij



APPENDIX F

Sterkte-coördinatie

Niet van toepassing voor dit masttype, zie inleiding.

APPENDIX G

Galloping

Uitgangspunten

In het uitgangspuntendocument is beschreven dat wordt uitgegaan van een materiaalfactor voor vermoeiing $\gamma_{mf} = 1,15$. Dit komt overeen met de "Safe-life methode" met "Low consequence" van tabel 3.1 van NEN-EN 1993-1-9 of met "Damage tolerant" en "High consequence".

Assessment method	Consequence of failure	
	Low consequence	High consequence
Damage tolerant	1,00	1,15
Safe life	1,15	1,35

Voor staven met gatverzwakking met bouten in ruime gaten geldt volgens fig. 8.1 van NEN-EN 1993-1-9 categorie 50, met $m=3$



Voor niet voorgespannen bouten belast op afschuiving geldt volgens fig. 8.1 van NEN-EN 1993-1-9 categorie 100, met $m=5$.

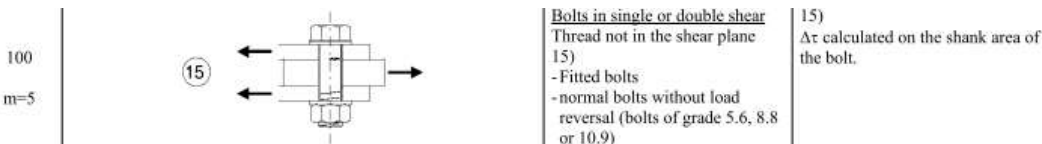

Het belastingspectrum is in de NNA (NEN-EN 50341-2-15) als volgt gedefinieerd.

Table 4.11/NL.1 Load spectra line galloping for tension supports

Load spectra line galloping for tension supports		Number of load cycles in 50 years	
Number	Peak-to-peak load	Ice region A	Ice region B
1	2·EDS	7.000	3.000
2	1,5·EDS	36.000	17.000
3	1,0·EDS	125.000	65.000
4	0,5·EDS	482.000	265.000

Aanpak

De vier belastingen van 0,5 tot 2,0EDS hebben een vaste onderlinge verhouding. Aangezien het aantal wisselingen zich in het $m=3$ gebied van de vermoeiingskromme bevindt vanwege $n < 2 \times 10^6$, kan een relatie worden afgeleid tussen de grootte van de spanningswissel met bijvoorbeeld 1,0EDS en de spanningswisseling die bij 2×10^6 wisselingen op basis van het spectrum nog net toelaatbaar is. Dit staat bekend als de equivalente spanningen methode. Via de factor lambda kan de spanningswisseling worden berekend.

$$\lambda = \left[\frac{\sum \Delta\sigma_i^m \cdot n_i}{2 \cdot 10^6} \right]^{\frac{1}{m}}$$

Toepassen van de formule voor een spanning van 1 N/mm² bij 1,0EDS levert:

Helling Ijsgebied Wisseling	m=3		m=5	
	A	B	A	B
	$\sigma_i^m \times n_i$	$\sigma_i^m \times n_i$	$\sigma_i^m \times n_i$	$\sigma_i^m \times n_i$
2,0EDS	5,60E+04	2,40E+04	2,24E+05	9,60E+04
1,5EDS	1,22E+05	5,74E+04	2,73E+05	1,29E+05
1,0EDS	1,25E+05	6,50E+04	1,25E+05	6,50E+04
0,5EDS	6,03E+04	3,31E+04	1,51E+04	8,28E+03
$\Sigma \sigma_i^m \times n_i$	3,63E+05	1,80E+05	6,37E+05	2,98E+05
$\lambda = (\Sigma \sigma_i n_i / 2 \times 10^6)^{1/m}$	0,57	0,45	0,80	0,68

Voor ijsgebied A is de toelaatbare spanningswisseling bij 1,0 EDS en 125.000 wisselingen dus 1/0,57 (175%) van de toelaatbare spanningswisseling bij een aantal wisselingen van $2,0 \times 10^6$. Er kan ook worden gesteld dat als de spanningswisselingen van 1,0 EDS 363.000 maal voorkomen, dezelfde schade wordt behaald als de vier niveaus afzonderlijk. Deze aanpak is gehanteerd.

- In de berekening van de mast wordt telkens één afspanpunt van de geleiders belast met een trekkracht in lijnrichting van 1,0 EDS.
- Het aantal wisselingen dat deze trekkracht voorkomt wordt vergroot om het hele spectrum te vervangen, dit is afhankelijk van ijsgebied en m-factor.
- Voor iedere staaf in de constructie wordt de schade berekend als gevolg van de trekkracht voor elke geleider.
- De schade wordt gesommeerd over alle geleiders.
- De toetsing is uitgedrukt als de verhouding tussen de optredende spanningswisseling bij $n = 2 \times 10^6$ wisselingen en de toelaatbare spanningswisseling (43 MPa voor het staalprofiel en 87 MPa voor de bout).

Resultaten

In de tabellen zijn de resultaten van mast EA-3/co gegeven. Vanwege de exponentiële invloed van het spanningsniveau heeft de verdeling van de U.C.'s een grote variatie. Het meest zwaar belast zijn de diagonalen in het ondervlak van de traverse in de nabijheid van de afspanpunten en de randen van de traverse. De conclusie is dat de staven en bouten voldoen.

Check galloping

RLI-TLB
EA-3/co

Datum: 30-6-2021
Auteur: JSN
Versie: 1.0



Group	Omschrijving	Profiel	Aantal bouten	Controle netto oppervlak profiel										Controle boutdoorsnede									
				ΔF _o [kN]	Brutto [mm ²]	Netto [mm ²]	Δσ _i /σ _o [Mpa]	DC _i /σ _o [Mpa]	DC _i /σ _o [Mpa]	UC opp. [kN]	UC ΔF _b Bout [mm ²]	Opp. Bout [mm ²]	Δσ _i /j _b [Mpa]	DC _i /j _b [Mpa]	Δσ _i /c _b [Mpa]	UC bout							
532	Upper chord mid ca.	100x100x10	4 M24	23.8	1920	1660	14.4	50	43	0.33	36.2	452	20.0	100	87	0.23							
533	Upper chord mid ca.	100x100x10	2 M24	27.4	1920	1660	16.5	50	43	0.38	41.6	452	46.0	100	87	0.53							
535	Stability bracing mid ca.	70x70x6	1 M16	0.4	810	702	0.6	50	43	0.01	0.6	201	2.9	100	87	0.03							
536	Hand rail	60x60x6	1 M16	0.1	690	582	0.2	50	43	0.00	0.2	201	0.8	100	87	0.01							
537	Hand rail	100x50x6	1 M16	0.0	870	762	0.0	50	43	0.00	0.0	201	0.0	100	87	0.00							
538	Hand rail	60x60x6	1 M16	0.1	690	582	0.1	50	43	0.00	0.1	201	0.4	100	87	0.00							
539	Stability bracing mid ca.	70x70x6	1 M16	1.2	810	702	1.8	50	43	0.04	1.7	201	8.4	100	87	0.10							
540	Vertical side face mid ca.	80x80x6	2 M20	5.4	940	808	6.6	50	43	0.15	8.1	314	12.9	100	87	0.15							
541	Vertical side face mid ca.	80x80x6	2 M20	5.6	940	808	7.0	50	43	0.16	8.6	314	13.6	100	87	0.16							
542	Vertical side face mid ca.	70x70x6	2 M20	1.6	810	678	2.3	50	43	0.05	2.4	314	3.8	100	87	0.04							
543	Vertical side face mid ca.	60x60x6	1 M16	2.3	690	582	4.0	50	43	0.09	3.5	201	17.6	100	87	0.20							
544	Vertical side face mid ca.	60x60x6	1 M16	2.8	690	582	4.8	50	43	0.11	4.3	201	21.4	100	87	0.25							
545	Vertical side face mid ca.	60x60x6	1 M16	0.3	690	582	0.6	50	43	0.01	0.5	201	2.5	100	87	0.03							
546	Vertical side face mid ca.	60x60x6	2 M16	12.2	690	582	20.9	50	43	0.48	18.5	201	46.1	100	87	0.53							
560	Diag side face mid ca.	80x80x6	2 M20	5.8	940	808	7.1	50	43	0.16	8.8	314	14.0	100	87	0.16							
561	Diag side face mid ca.	80x80x6	2 M20	8.1	940	808	10.1	50	43	0.23	12.2	314	19.5	100	87	0.22							
562	Diag side face mid ca.	80x80x8	2 M20	9.1	1230	1054	8.6	50	43	0.20	13.7	314	21.9	100	87	0.25							
563	Diag side face mid ca.	60x60x6	2 M16	2.8	690	582	4.8	50	43	0.11	4.2	201	10.5	100	87	0.12							
564	Diag side face mid ca.	60x60x6	2 M16	4.9	690	582	8.5	50	43	0.20	7.5	201	18.8	100	87	0.22							
565	Diag side face mid ca.	60x60x6	2 M16	5.9	690	582	10.2	50	43	0.23	9.0	201	22.4	100	87	0.26							
566	Diag side face mid ca.	60x60x6	2 M16	7.2	690	582	12.3	50	43	0.28	10.9	201	27.2	100	87	0.31							
573	Stability bracing mid ca.	70x70x6	1 M16	0.8	810	702	1.1	50	43	0.02	1.0	201	5.0	100	87	0.06							
574	Diag lower plane mid ca.	80x80x6	2 M20	10.9	940	808	13.5	50	43	0.31	15.2	314	24.3	100	87	0.28							
575	Diag lower plane mid ca.	80x80x6	2 M20	13.9	940	808	17.2	50	43	0.40	19.4	314	30.8	100	87	0.35							
576	Diag lower plane mid ca.	80x80x6	2 M20	14.3	940	808	17.7	50	43	0.41	19.9	314	31.8	100	87	0.37							
577	Diag lower plane mid ca.	70x70x7	2 M20	12.7	940	786	16.1	50	43	0.37	17.7	314	28.3	100	87	0.32							
578	Diag lower plane mid ca.	70x70x7	2 M20	16.0	940	786	20.4	50	43	0.47	22.4	314	35.6	100	87	0.41							
579	Diag lower plane mid ca.	70x70x6	2 M20	16.4	940	786	20.8	50	43	0.48	22.8	314	36.3	100	87	0.42							
580	Post insulator diagonal	70x70x6	2 M20	13.1	810	678	19.4	50	43	0.45	19.7	314	31.4	100	87	0.36							
581	Diag lower plane mid ca.	70x70x6	2 M20	1.7	810	678	2.5	50	43	0.06	2.6	314	4.2	100	87	0.05							
582	Diag lower plane mid ca.	70x70x6	2 M20	16.1	810	678	23.8	50	43	0.55	24.6	314	39.2	100	87	0.45							
583	Diag lower plane mid ca.	70x70x6	2 M20	17.4	810	678	25.6	50	43	0.59	26.5	314	42.2	100	87	0.49							
584	Diag lower plane mid ca.	70x70x6	2 M20	19.6	810	678	28.9	50	43	0.66	29.9	314	47.6	100	87	0.55							
585	Diag lower plane mid ca.	80x80x8	2 M20	22.5	940	786	28.6	50	43	0.60	34.4	314	54.7	100	87	0.63							
586	Diag lower plane mid ca.	80x80x8	2 M20	27.3	1230	1054	25.9	50	43	0.60	41.6	314	66.3	100	87	0.76							
587	Diag lower plane mid ca.	80x80x8	2 M20	30.7	1230	1054	29.1	50	43	0.67	46.9	314	74.7	100	87	0.86							
588	Plan bracing mid ca.	60x60x6	5 M24	11.6	690	582	19.9	50	43	0.46	17.7	201	43.9	100	87	0.51							
589	Plan bracing mid ca.	140x140x13	5 M24	86.6	3521	3183	27.2	50	43	0.63	131.8	452	58.3	100	87	0.67							
600	Horizontal top ca.	150x150x18	4 M24	55.4	3480	3168	17.5	50	43	0.40	84.3	452	46.6	100	87	0.54							
601	Lower chord top ca.	200x200x18	16 M24	130.2	6910	6442	20.2	50	43	0.46	196.6	452	27.2	100	87	0.31							
602	Lower chord top ca.	180x180x18	16 M24	164.6	6190	5722	28.8	50	43	0.66	251.2	452	34.7	100	87	0.40							
603	Lower chord top ca.	150x150x14	8 M24	99.9	4014	3650	27.4	50	43	0.63	152.4	452	42.2	100	87	0.48							
604	Lower chord top ca.	150x150x14	0	42.0	4014	4014	10.5	50	43	0.24	64.0	0	0.0	100	87	0.00							
605	Lower chord top ca.	150x150x14	0	15.4	4014	4014	3.8	50	43	0.09	22.4	0	0.0	100	87	0.00							

Check galloping

Datum: 30-6-2021
 Auteur: JSN
 Versie: 1.0



RLI-TLB
 EA-3/co

Group	Omschrijving	Profiel	Aantal bouten	Controle netto oppervlak profiel						Controle boutdoorsnede						
				ΔF _o [kN]	Brutto [mm ²]	Netto [mm ²]	Δσ _i [Mpa]	DC _i [Mpa]	Δσ _c [Mpa]	UC opp.	ΔF _b [kN]	Bout [mm ²]	Opp. Bout	Δσ _i [Mpa]	DC _i [Mpa]	Δσ _c [Mpa]
606	Lower chord top ca.	150x150x14	0	4.8	4014	4014	1.2	50	43	0.03	6.6	0	0.0	100	87	0.00
608	Earth peak lower chord	80x80x8	2 M20	6.8	1230	1054	6.5	50	43	0.15	9.2	314	14.7	100	87	0.17
609	Earth peak lower chord	80x80x8	2 M20	5.3	1230	1054	5.1	50	43	0.12	7.1	314	11.3	100	87	0.13
610	Horizontal top ca.	130x130x12	3 M24	41.8	3000	2688	15.6	50	43	0.36	62.7	452	46.2	100	87	0.53
611	Beam top ca.	150x150x14 (not coupled)	2 M24	13.6	8028	7664	1.8	50	43	0.04	20.8	452	23.0	100	87	0.26
612	Post insulator cantilever	150x150x14 (not coupled)	0	0.4	8028	8028	0.1	50	43	0.00	0.6	0	0.0	100	87	0.00
613	Post insulator end beam	HEB160	0	0.2	5430	5430	0.0	50	43	0.00	0.3	0	0.0	100	87	0.00
614	Beam top ca.	UNP220	0	1.1	3740	3740	0.3	50	43	0.01	1.7	0	0.0	100	87	0.00
615	Beam top ca.	HEB180	0	0.9	6530	6530	0.1	50	43	0.00	1.3	0	0.0	100	87	0.00
616	Beam top ca.	150x150x18 (not coupled)	2 M24	27.0	10200	9732	2.8	50	43	0.06	41.2	452	45.5	100	87	0.52
617	Beam top ca.	UNP220	0	4.5	3740	3740	1.2	50	43	0.03	6.9	0	0.0	100	87	0.00
618	Beam top ca.	HEB220	0	1.7	9104	9104	0.2	50	43	0.00	2.6	0	0.0	100	87	0.00
619	Earth peak horizontal	60x60x6	1 M16	0.7	690	582	1.3	50	43	0.03	1.1	201	5.6	100	87	0.06
620	Earth peak horizontal	60x60x6	1 M16	0.7	690	582	1.2	50	43	0.03	1.1	201	5.3	100	87	0.06
621	Earth peak horizontal	60x60x6	1 M16	0.0	690	582	0.0	50	43	0.00	0.0	201	0.1	100	87	0.00
626	Upper chord top ca.	130x130x12	5 M24	39.0	3000	2688	14.5	50	43	0.33	59.5	452	26.3	100	87	0.30
627	Upper chord top ca.	100x100x10	4 M24	14.6	1920	1660	8.8	50	43	0.20	22.2	452	12.3	100	87	0.14
628	Upper chord top ca.	100x100x10	6 M24	14.1	1920	1660	8.5	50	43	0.19	21.4	452	7.9	100	87	0.09
629	Upper chord top ca.	100x100x10	3 M24	14.2	1920	1660	8.6	50	43	0.20	21.7	452	16.0	100	87	0.18
630	Earth peak upper chord	150x150x12	6 M24	54.3	3480	3168	17.1	50	43	0.39	74.6	452	27.5	100	87	0.32
631	Earth peak upper chord	150x150x12	4 M24	47.3	3480	3168	14.9	50	43	0.34	66.5	452	36.8	100	87	0.42
632	Earth peak upper chord	120x120x10	4 M24	45.3	2320	2060	22.0	50	43	0.51	63.6	452	35.2	100	87	0.40
633	Earth peak upper chord	120x120x10	0	39.2	2320	2320	16.9	50	43	0.39	55.0	0	0.0	100	87	0.00
634	Earth peak upper chord	120x120x10	0	30.4	2320	2320	13.1	50	43	0.30	42.6	0	0.0	100	87	0.00
635	Earth peak upper chord	120x120x10	2 M20	16.1	2320	2100	7.7	50	43	0.18	22.6	314	36.0	100	87	0.41
637	Stability bracing top ca.	70x70x7	2 M20	9.8	940	786	12.5	50	43	0.29	14.8	314	47.3	100	87	0.54
638	Earth peak beam	UNP160	2 M20	4.7	2400	2235	2.1	50	43	0.05	6.7	314	10.6	100	87	0.12
640	Vertical side face top ca.	70x70x6	2 M20	3.5	810	678	5.2	50	43	0.12	5.1	314	8.2	100	87	0.09
641	Vertical side face top ca.	80x80x8	2 M20	14.8	1230	1054	14.1	50	43	0.32	22.4	314	35.7	100	87	0.41
642	Vertical side face top ca.	80x80x6	1 M16	3.1	940	832	3.7	50	43	0.08	4.6	201	22.7	100	87	0.26
643	Vertical side face top ca.	80x80x6	1 M16	0.2	940	832	0.2	50	43	0.01	0.3	201	1.4	100	87	0.02
644	Vertical side face top ca.	80x80x6	1 M16	6.2	940	832	7.4	50	43	0.17	9.4	201	46.7	100	87	0.54
645	Vertical side face top ca.	80x80x8	1 M16	0.1	1230	1086	0.1	50	43	0.00	0.2	201	0.8	100	87	0.01
646	Earth peak vertical side face	60x60x6	1 M16	0.2	690	582	0.3	50	43	0.01	0.3	201	1.4	100	87	0.02
660	Diag side face top ca.	70x70x6	2 M20	5.1	810	678	7.5	50	43	0.17	7.0	314	11.2	100	87	0.13
661	Diag side face top ca.	80x80x8	2 M16	5.1	1230	1086	4.7	50	43	0.11	7.5	201	18.8	100	87	0.22
662	Diag side face top ca.	70x70x7	2 M20	6.6	940	786	8.4	50	43	0.19	9.8	314	15.5	100	87	0.18
663	Earth peak diag side face	80x80x6	1 M16	0.2	940	832	0.2	50	43	0.00	0.2	201	1.1	100	87	0.01
664	Stability bracing top ca.	90x90x8	2 M20	18.6	1390	1214	15.3	50	43	0.35	28.2	314	44.8	100	87	0.52
672	Earth peak diag upper side	60x60x6	2 M16	7.7	690	582	13.2	50	43	0.30	10.8	201	26.8	100	87	0.31
673	Earth peak diag upper side	60x60x6	2 M16	6.0	690	582	10.2	50	43	0.24	8.4	201	20.8	100	87	0.24
674	Diag lower plane top ca.	70x70x6	2 M20	12.8	810	678	18.9	50	43	0.44	17.9	314	28.5	100	87	0.33
675	Diag lower plane top ca.	70x70x6	2 M20	17.0	810	678	25.1	50	43	0.58	23.8	314	37.9	100	87	0.44
676	Diag lower plane top ca.	70x70x6	2 M20	15.3	810	678	22.5	50	43	0.52	21.3	314	33.9	100	87	0.39
677	Post insulator diagonal	70x70x6	2 M20	0.8	810	678	1.3	50	43	0.03	1.2	314	2.0	100	87	0.02



Check galloping

Datum: 30-6-2021
 Auteur: JSN
 Versie: 1.0

RLI-TLB
 EA-3/co

Group	Omschrijving	Profiel	Aantal bouten	Controle netto oppervlak profiel						Controle boutdoorsnede						
				ΔF;o [kN]	Brutto [mm2]	Netto [mm2]	Δσ;i;o [Mpa]	DC;o [Mpa]	Δσ;c;o [Mpa]	UC opp. [kN]	ΔF;b Bout [mm2]	Opp. Bout [mm2]	Δσ;j;b [Mpa]	DC;b [Mpa]	Δσ;c;b [Mpa]	UC bout
678	Diag lower plane top ca.	70x70x6	2 M20	12.8	810	678	18.9	50	43	0.43	19.4	314	30.9	100	87	0.35
679	Diag lower plane top ca.	70x70x6	2 M20	12.3	810	678	18.1	50	43	0.42	18.7	314	29.8	100	87	0.34
680	Diag lower plane top ca.	70x70x6	2 M20	14.5	810	678	21.4	50	43	0.49	22.2	314	35.3	100	87	0.41
681	Diag lower plane top ca.	80x80x8	2 M20	26.9	1230	1054	25.6	50	43	0.59	41.1	314	65.5	100	87	0.75
682	Diag lower plane top ca.	80x80x8	2 M20	28.7	1230	1054	27.2	50	43	0.63	43.8	314	69.8	100	87	0.80
683	Diag lower plane top ca.	80x80x8	2 M20	30.2	1230	1054	28.7	50	43	0.66	46.2	314	73.5	100	87	0.85
684	Diag lower plane top ca.	80x80x8	2 M20	30.5	1230	1054	29.0	50	43	0.67	46.6	314	74.2	100	87	0.85
685	Diag lower plane top ca.	60x60x6	2 M16	11.3	690	582	19.4	50	43	0.45	17.3	201	42.9	100	87	0.49
686	Earth peak diag lower plane	70x70x7	1 M16	0.4	940	814	0.4	50	43	0.01	0.5	201	2.7	100	87	0.03
687	Earth peak diag lower plane	70x70x7	1 M16	2.2	940	814	2.7	50	43	0.06	3.3	201	16.4	100	87	0.19
688	Earth peak diag upper plane	70x70x6	2 M16	8.9	810	702	12.7	50	43	0.29	13.3	201	33.1	100	87	0.38
689	Earth peak diag upper plane	70x70x6	2 M16	10.2	810	702	14.5	50	43	0.33	15.2	201	37.8	100	87	0.44
690	Earth peak diag upper plane	70x70x6	2 M16	10.9	810	702	15.5	50	43	0.36	16.3	201	40.5	100	87	0.47
691	Earth peak diag upper plane	70x70x6	2 M16	11.8	810	702	16.8	50	43	0.39	17.7	201	44.0	100	87	0.51
692	Earth peak diag upper plane	60x60x6	1 M16	2.4	690	582	4.0	50	43	0.09	3.3	201	16.4	100	87	0.19
693	Earth peak diag upper plane	60x60x6	1 M16	2.6	690	582	4.5	50	43	0.10	3.7	201	18.2	100	87	0.21
694	Earth peak diag upper plane	60x60x6	1 M16	2.9	690	582	5.0	50	43	0.11	4.1	201	20.2	100	87	0.23
695	Earth peak diag upper plane	60x60x6	1 M16	3.3	690	582	5.6	50	43	0.13	4.6	201	22.9	100	87	0.26
696	Earth peak diag upper plane	60x60x6	1 M16	3.9	690	582	6.7	50	43	0.15	5.5	201	27.4	100	87	0.31
697	Earth peak diag upper plane	60x60x6	1 M16	4.7	690	582	8.1	50	43	0.19	6.6	201	33.0	100	87	0.38
698	Plan bracing top ca.	150x150x12	4 M24	55.5	3480	3168	17.5	50	43	0.40	83.3	452	46.1	100	87	0.53
699	Plan bracing top ca.	140x140x13	5 M24	91.3	3521	3183	28.7	50	43	0.66	136.7	452	60.5	100	87	0.70
700	Hor. Plan bracing hip structure	100x100x8	2 M20	2.3	1550	1374	1.7	50	43	0.04	3.1	314	4.9	100	87	0.06
701	Hor. Plan bracing hip structure	100x100x8	2 M20	0.5	1550	1374	0.4	50	43	0.01	0.8	314	1.3	100	87	0.02
702	Hor. Plan bracing hip structure	100x100x8 (not coupled)	2 M20	0.0	3100	2924	0.0	50	43	0.00	0.0	314	0.0	100	87	0.00
703	2nd plan bacing	130x130x12#(15,0.33)	3 M24	14.6	6040	5728	2.5	50	43	0.06	19.9	452	14.7	100	87	0.17
704	2nd plan bacing	90x90x8	2 M20	4.1	1390	1214	3.3	50	43	0.08	6.2	314	9.8	100	87	0.11
705	2nd plan bacing	90x90x8 (not coupled)	2 M20	0.0	2780	2604	0.0	50	43	0.00	0.0	314	0.0	100	87	0.00
710	Horizontal top of lower ca.	130x130x12	5 M24	10.4	3000	2688	3.9	50	43	0.09	14.2	452	6.3	100	87	0.07
711	Horizontal top of lower ca.	120x120x10	2 M24	1.2	2320	2060	0.6	50	43	0.01	1.6	452	1.7	100	87	0.02
712	Horizontal top of mid ca.	130x130x12	5 M24	12.0	3000	2688	4.5	50	43	0.10	16.1	452	7.1	100	87	0.08
713	Horizontal top of mid ca.	110x110x10	2 M24	1.7	2112	1852	0.9	50	43	0.02	2.6	452	2.9	100	87	0.03
714	Horizontal top of top ca.	140x140x13	5 M24	19.1	3521	3183	6.0	50	43	0.14	29.2	452	12.9	100	87	0.15
715	Horizontal top of top ca.	100x100x10	2 M24	0.9	1920	1660	0.6	50	43	0.01	1.4	452	1.6	100	87	0.02



About DNV

DNV is the independent expert in risk management and assurance, operating in more than 100 countries. Through its broad experience and deep expertise DNV advances safety and sustainable performance, sets industry benchmarks, and inspires and invents solutions.

Whether assessing a new ship design, optimizing the performance of a wind farm, analyzing sensor data from a gas pipeline or certifying a food company's supply chain, DNV enables its customers and their stakeholders to make critical decisions with confidence.

Driven by its purpose, to safeguard life, property, and the environment, DNV helps tackle the challenges and global transformations facing its customers and the world today and is a trusted voice for many of the world's most successful and forward-thinking companies.