

B.2 002.678.00 0927722 Mastrapportage S_c



ZUID-WEST 380 KV OOST VERBINDINGEN

Mastrapport combi-steinmasten

TenneT TSO B.V.

Meridian doc.nr.: 002.678.00.0927722

Rapport nr.: 21-0728, Rev. 1

Datum: 28-07-2021





Projectnaam: Zuid-West 380 kV Oost Verbindingen Energy Systems
Rapport titel: Mastrapport combi-steunmasten DNV Netherlands B.V.
Klant: TenneT TSO B.V., Utrechtseweg 310, 6812 AR Arnhem Utrechtseweg 310-B50
Contactpersoon klant: ██████████ 6812 AR Arnhem
Datum uitgave: 28-07-2021
Project nr.: 10124719
Organisatie unit: Transmission & Distribution Technology (TDT) Tel: 026 356 9111
Meridian doc.nr.: 002.678.00.0927722 Handelsregister Arnhem 09006404
Rapport nr.: 21-0728, Rev. 1

Geschreven door: Beoordeeld door: Goedgekeurd door:

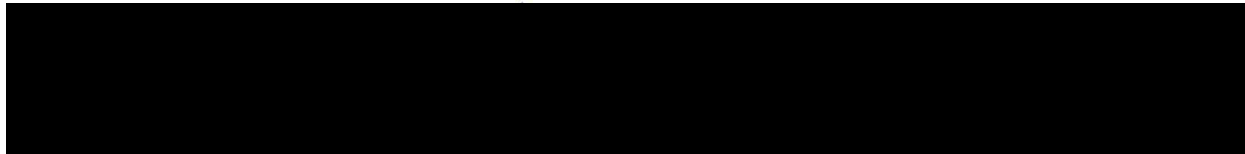

Copyright © DNV 2021. All rights reserved. Unless otherwise agreed in writing: (i) This publication or parts thereof may not be copied, reproduced or transmitted in any form, or by any means, whether digitally or otherwise; (ii) The content of this publication shall be kept confidential by the customer; (iii) No third party may rely on its contents; and (iv) DNV undertakes no duty of care toward any third party. Reference to part of this publication which may lead to misinterpretation is prohibited.

DNV Distributie:

- Open
- Intern
- Commercieel vertrouwelijk
- Vertrouwelijk
- Geheim

*Specificatie distributie: --

Trefwoorden:

[Trefwoorden]

Rev.	Datum	Reden van uitgave	Auteur	Beoordelaar	Goedgeuder
0	07-05-2021	Eerste uitgave	██████████		
0	28-07-2021	RFA-commentaar verwerkt	██████████		

Inhoudsopgave

1	INLEIDING	1
2	UITGANGSPUNTEN EN RANDVOORWAARDEN	2
2.1	Normen	2
2.2	TenneT-specificaties	2
2.3	Eisenverificatie	2
2.4	Ontwerprapporten	2
2.5	Materialen	2
2.6	Software	3
3	MASTONTWERP	4
3.1	Mastbeelden	4
3.2	Uitgangspunten berekening	11
3.3	Mastenlijst	11
3.4	Geleiderbelastingen	14
3.5	Reacties op de fundering	14
3.6	Modellering	14
3.7	Overige controles	14
3.8	Mastgewicht	14
4	TOETSING	15
4.1	Resultaat PLS-TOWER	15
4.2	Toetsing overige onderdelen	21
Appendix A	Geleiderbelastingen	
Appendix B	Resultaten PLS-TOWER	
Appendix C	Knikverkorters	
Appendix D	Blokdeuvels	
Appendix E	Liggers	
Appendix F	Sterkte-coördinatie	

1 INLEIDING

In het basisontwerp van de vakwerkmasten voor de verbinding RLL-TLB380 in het project Zuid-West 380 kV-Oost zijn voor het vaststellen van de haalbaarheid constructieve berekeningen uitgevoerd aan de masten en fundaties. In de Definitief Ontwerpfase, moeten berekeningen verder worden uitgewerkt om te kunnen dienen voor de benodigde vergunningsdocumentatie, voor de aanbesteding en als voorbereiding voor de uitvoeringsfase. Het DO omvat het ontwerp van de mastconstructies, de fundaties en de opstijpunten in de verbinding.

Deze rapportage bevat de resultaten van de toetsing van alle masttypen binnen de groep van de combi-steunmasten, een masttype dat geschikt is voor twee circuits 380 kV en twee circuits 150 kV. Het ontwerp van de combi-steunmasten S-3/c t/m S+12/c is zodanig dat de "mastkop" gedeeld wordt binnen de groep van de combi-steunmasten, alleen de hoogte van het onderstuk verschilt.

In deze rapportage is de toetsing van de mastkop van de combi-steunmasten en de toetsing van alle onderstukken van de verschillende typen opgenomen. De toetsing bestaat uit controle van:

- de profielen en boutverbindingen onderdeel van de hoofd draagconstructie
- de knikverkorters
- de liggers voor de isolator kettingen
- de verbinding met de fundatie via blokdeuvels
- aanvullende controle op sterkte-coördinatie

Buiten de scope van dit DO-rapport valt de controle van de schetsplaten en overige verbinding details in de constructie. Dit moet in de UO-fase worden uitgewerkt. Ook de voorzieningen voor de high-step rail en bordessen vallen onder uitwerking in UO-fase.

In hoofdstuk 2 zijn de uitgangspunten en randvoorwaarden vanuit de van toepassing zijnde normen en TenneT-specificaties opgenomen. Hoofdstuk 3 beschrijft de gevolgde aanpak van de berekening. In hoofdstuk 4 is de toetsing opgenomen.

2 UITGANGSPUNTEN EN RANDVOORWAARDEN

2.1 Normen

Er is gebruik gemaakt van de normen volgens Tabel 1.

Tabel 1 Gebruikgemaakte normen, voorschriften en richtlijnen

Norm	Titel
NEN-EN 50341-1:2013	“Overhead electrical lines exceeding AC 1 kV - Part 1: General requirements – Common”
NEN-EN 50341-2-15:2019	“Overhead electrical lines exceeding AC 1 kV Part 2 National Normative Aspects (NNA) for THE NETHERLANDS”
NEN-EN 1990+A1+A1/C2:2019/NB:2019nl	“Grondslagen van het ontwerp”
NEN-EN 1991-1-4+A1+C2:2011/NB:2019+C1:2020	“Deel 1-4: Windbelasting op constructies”
NEN-EN 1992-1-1+C2:2011/NB:2016+A1:2020	“Eurocode 2: Ontwerp en berekening van betonconstructies, deel 1-1: algemene regels en regels voor gebouwen”
NEN-EN 1993-1-1+C2+A1:2016 nl	“Eurocode 3: Ontwerp en berekening van staalconstructies, deel 1-1: algemene regels en regels voor gebouwen”
NEN-EN 1993-3-1:2007/NB:2011 nl	“Deel 3-1: Torens, masten en schoorstenen - Torens en masten”
NEN-EN 1993-1-8+C2:2011/NB:2011 nl	“Ontwerp en berekening van staalconstructies, deel 1-8: ontwerp en berekening van verbindingen”

2.2 TenneT-specificaties

In Tabel 2 zijn de documenten opgenomen die relevant zijn voor de berekeningen en toetsingen die binnen dit project in de mastrapportage uitgevoerd zullen worden.

Tabel 2 Relevante documenten t.b.v. mechanische rapportages

Nummer	Onderwerp
PVE.05.000 v3.2	PvE Lijnen
sPVE.05.001	sPvE Lijnen
SPE.05.346 v1.3	Algemene specificatie stalen masten

2.3 Eisenverificatie

Voor de eisenverificatie wordt verwezen naar het rapport “Verificatierapport eisen DO Moldau”, DNV GL rapport 21-0451, Meridiannummer 002.678.00 0910757.

2.4 Ontwerpprojecten

Voor de achtergrond van het ontwerp wordt verwezen naar het uitgangspuntenrapport “Uitgangspunten definitief ontwerp Moldaumast”, DNV GL rapport 21-0036, Meridiannummer 002.678.00 0876917.

2.5 Materialen

Voor het ontwerp van de mastconstructies en fundaties wordt uitgegaan van de eigenschappen volgens Tabel 3.

Tabel 3 Materialen aangepaste constructie

Staalsoort	S355J0 (t≤16 mm) S355J2 (16<t≤40 mm)
Boutkwaliteit	8.8 gerolde draad
Betonkwaliteit	C30/37
Wapeningsstaal	B500



Voor de constructie geldt conform TenneT-specificatie:

- Toe te passen bouten: M16/M20/M24;
- Voor hoekstaal is de minimale afmeting L50x5 mm;
- Minimale plaatdikte 6 mm.

Mocht het noodzakelijk zijn M30 toe te passen, bij grote plaatdiktes is dit als afwijking door TenneT toegestaan.

2.6 Software

De gebruikte software wordt benoemd in Tabel 4.

Tabel 4 Toegepaste software

Software		Versie
Mastontwerp	PLS-CADD	16.65
Mastberekeningen	PLS-TOWER	16.65
Constructieve analyse	AxisVM	X5 R4h

3 MASTONTWERP

3.1 Mastbeelden

In dit hoofdstuk worden de mastbeelden weergegeven met de belangrijkste maatvoering, voor volledige tekeningen van de masttypen wordt verwezen naar onderstaande tekening:

- Mastbeeldtekening steunmasten, Meridiannummer 002.678.00 0890100
- Mastbeeldtekening S-3/c, Meridiannummer 002.678.00 0927444
- Mastbeeldtekening S+0/c, Meridiannummer 002.678.00 0901939
- Mastbeeldtekening S+3/c, Meridiannummer 002.678.00 0927446
- Mastbeeldtekening S+6/c, Meridiannummer 002.678.00 0927450
- Mastbeeldtekening S+9/c, Meridiannummer 002.678.00 0927458
- Mastbeeldtekening S+12/c, Meridiannummer 002.678.00 0927466

De combi-steunmasten voor twee circuits 380 kV en twee circuits 150kV zijn in oplopende hoogte in Figuur 1 weergegeven.

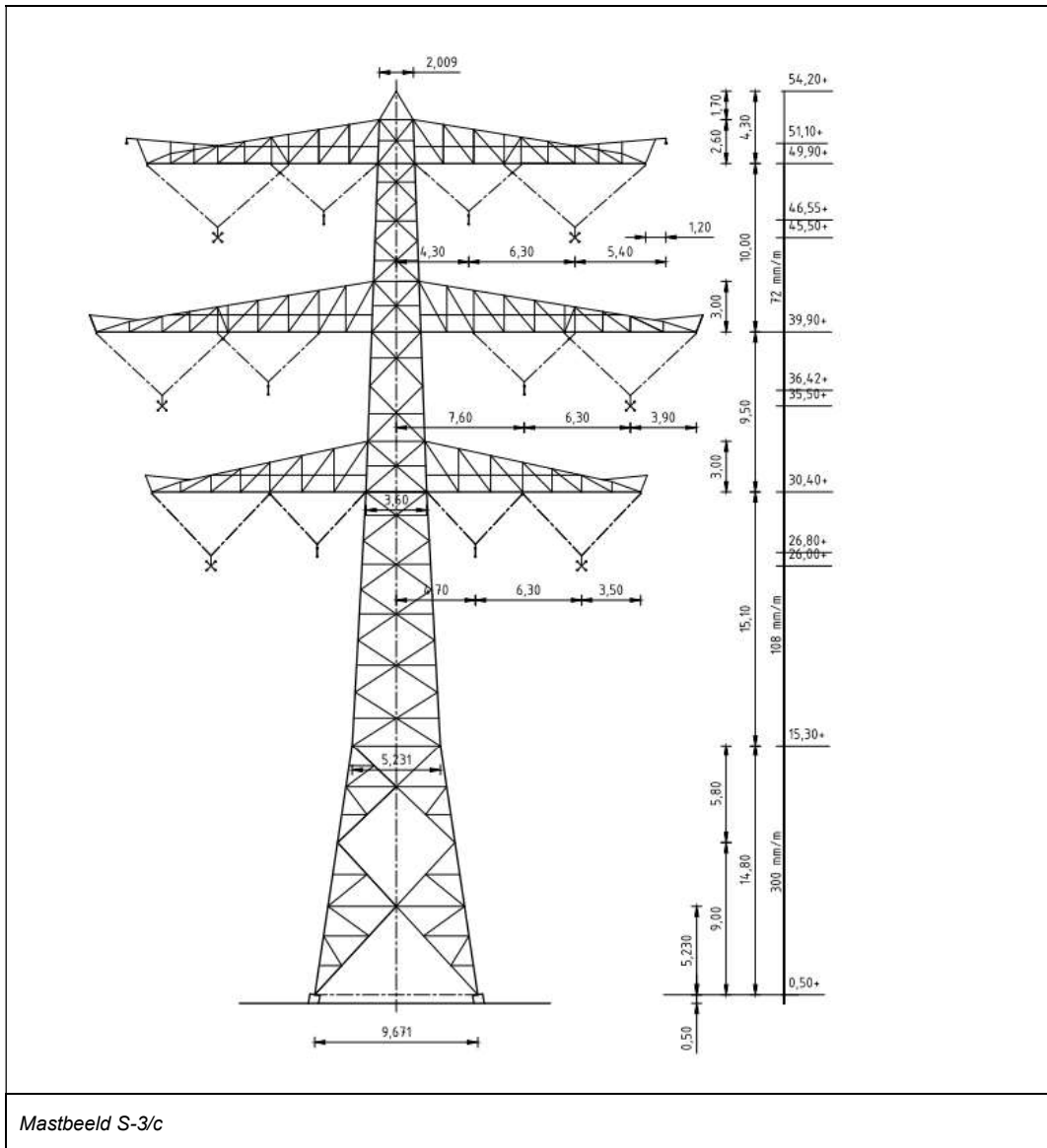

Mastbeeld S-3/c

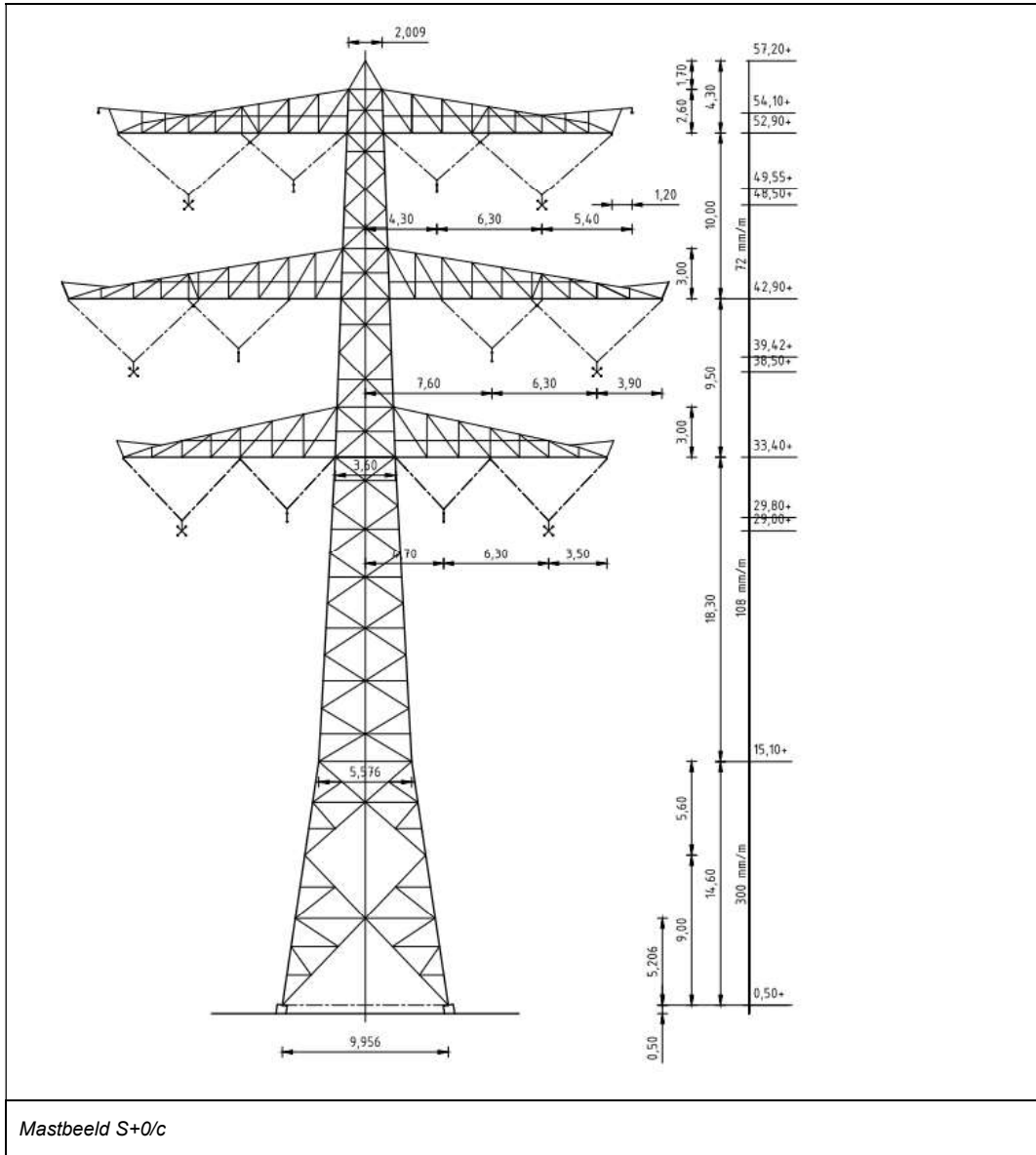

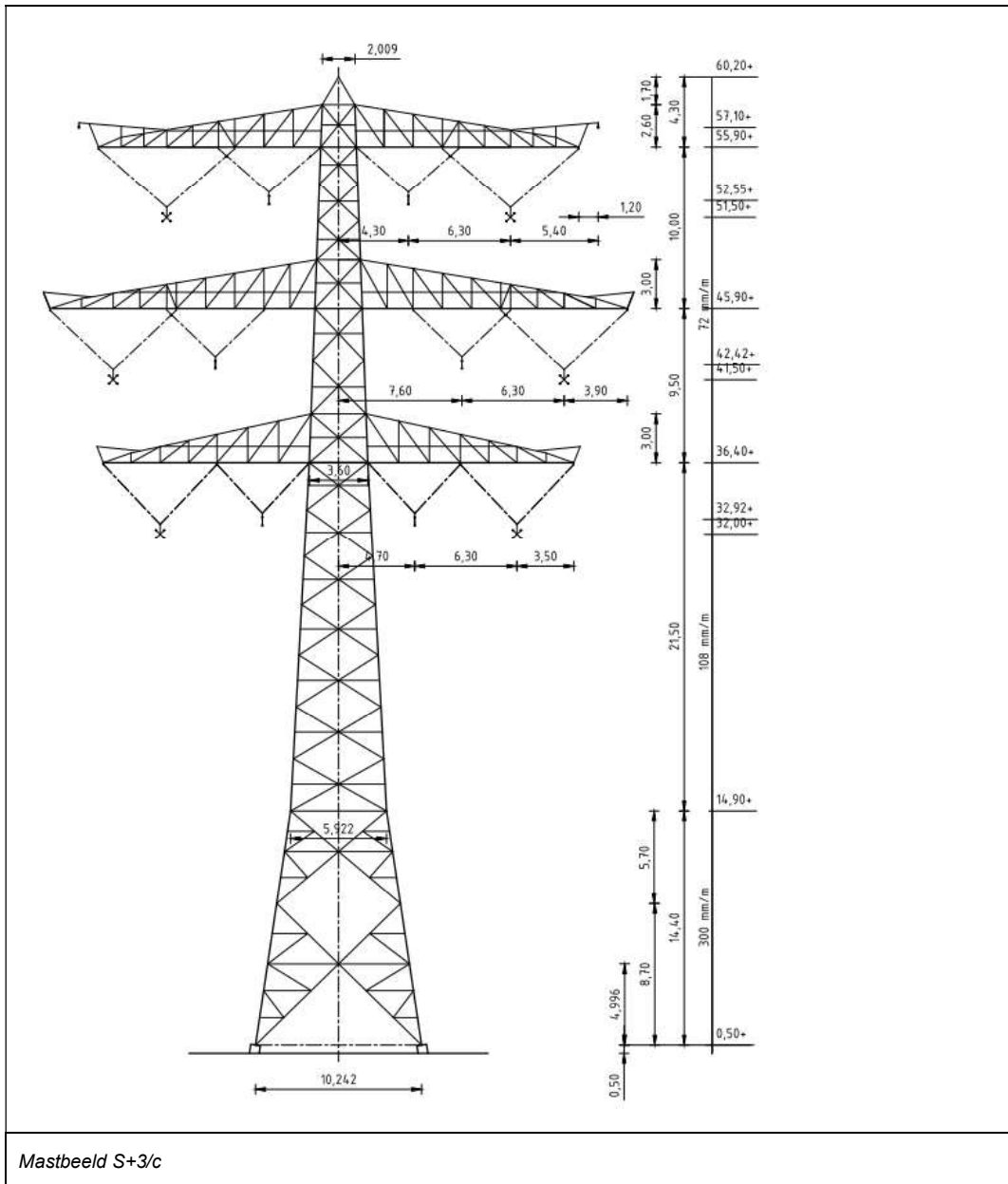

Mastbeeld S+3/c

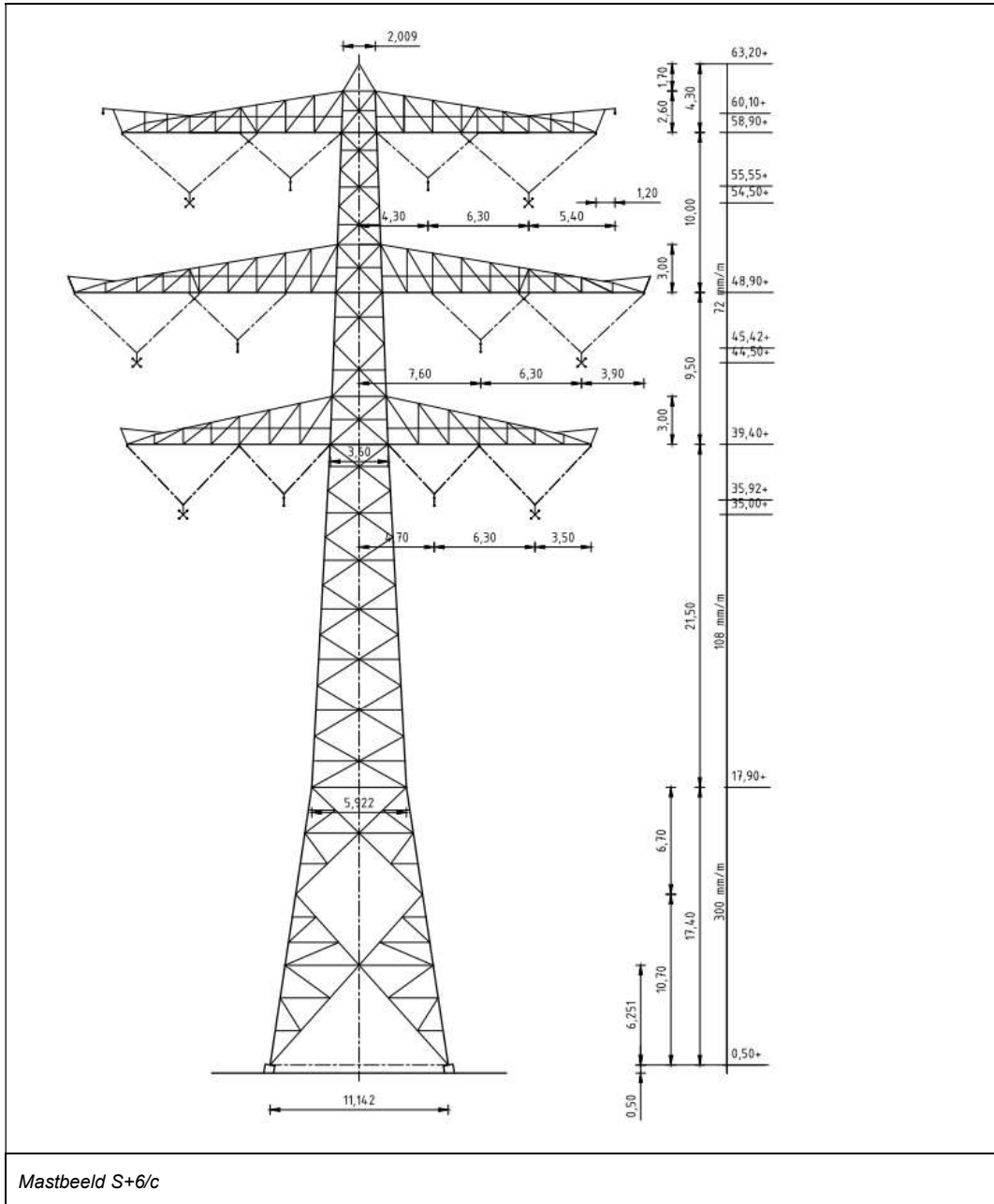

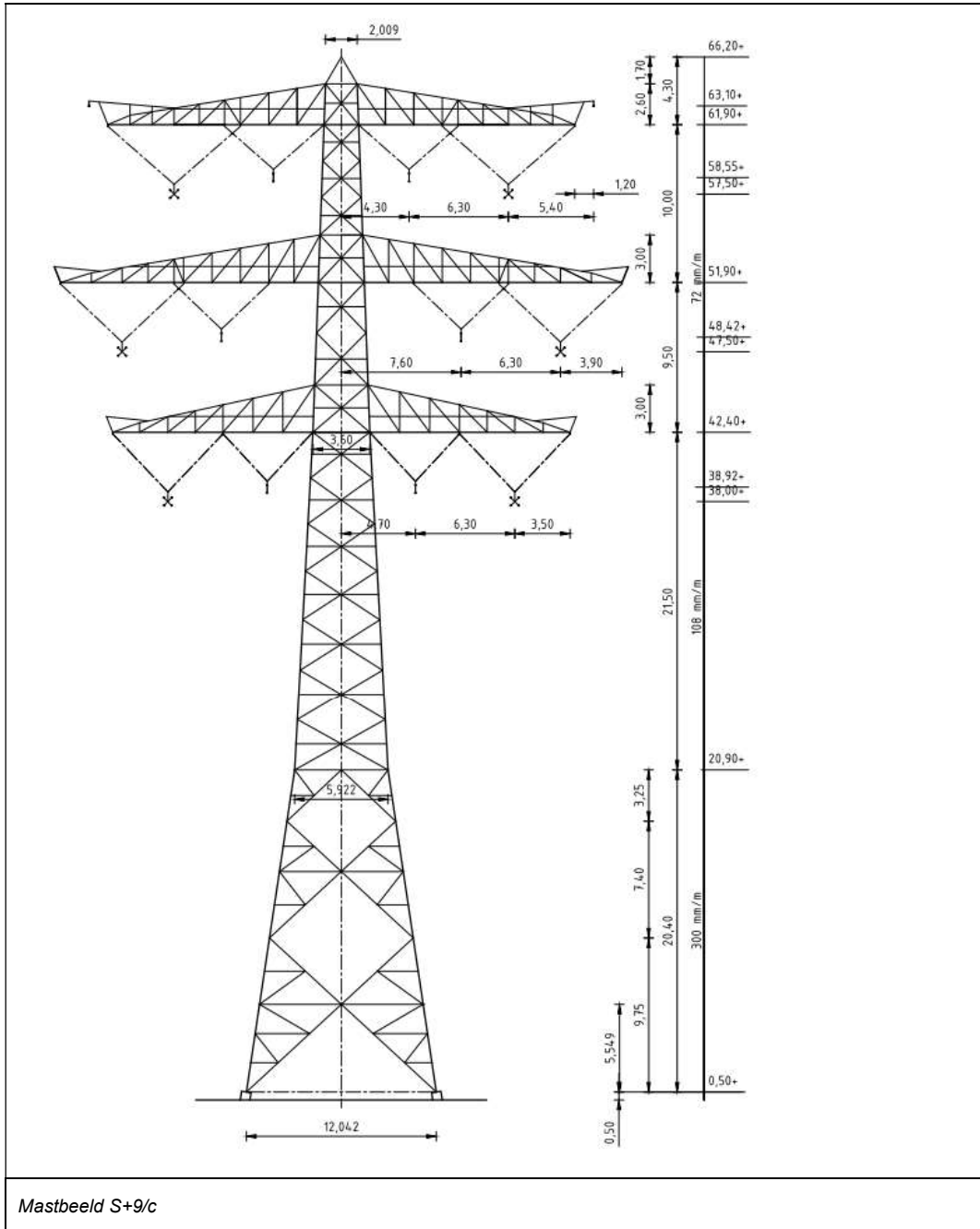

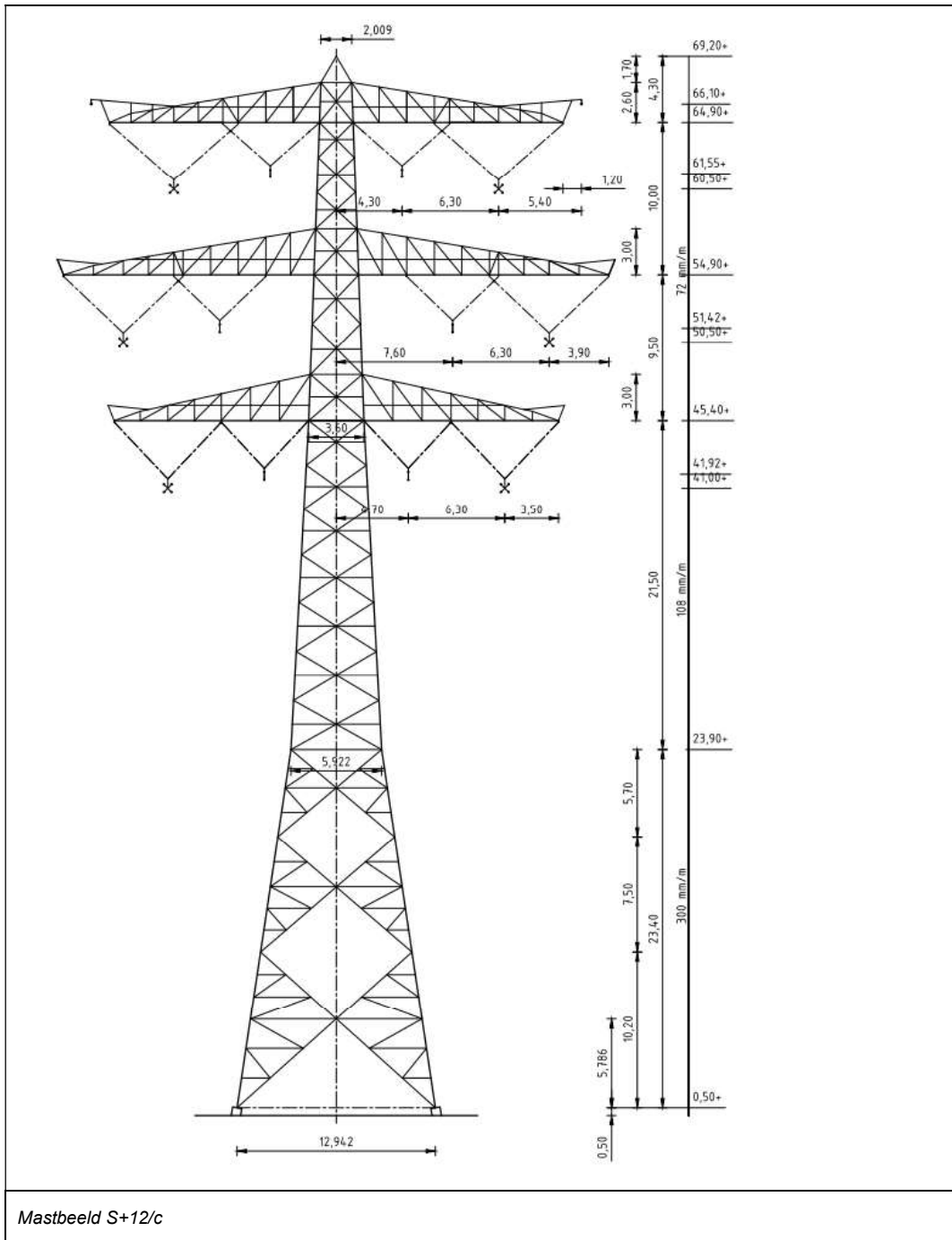

Figuur 1 Mastbeelden masttypes combi-steenmasten

3.2 Uitgangspunten berekening

De uitgangspunten volgens Tabel 5 zijn van toepassing.

Tabel 5 Uitgangspunten

Norm	NEN-EN50341-2-15:2019
Gevolgklasse initieel	CC2
Betrouwbaarheidsniveau	Nieuwbouw
Referentieperiode	50 jaar
Windgebied	III
Windsnelheid (m/s)	24,5 m/s
Terreincategorie	II
Reductiefactor c_{dir}	1,00
IJsg gebied fasegeleider	B
IJsg gebied bliksemgeleider	A

3.3 Mastenlijst

De mastenlijst is gebaseerd op de “staking table” van het DO-uitgangspuntenrapport en vernoemd als “VKA 1.1 Concept 20201112 1037-1044_1086-1094_1099-1105_1192-1204.xlsx”. De mastenlijst is vanwege lopende traceringsvraagstukken aan verandering onderhevig en is derhalve indicatief.

In Tabel 6 tot en met Tabel 11 zijn alle masten in het tracé van de type S-3/c t/m S+12/c opgenomen. De mast met grootste wind span is vetgedrukt aangegeven. Het masttype zal niet met deze wind en weight span worden berekend maar met generieke wind en weight span, zie uitgangspuntenrapport. In de tabellen zijn masttypes om praktische redenen aangeduid met “S_c” in plaats van “S/c”.

Tabel 6 Mastenlijst S-3/c

Mast-nummer	Masttype	Lijnhoek (°)	Wind span (m)	Weight span (m)	Hoogteverschil ba+ah (m)	Hoogteverschil back (m)	Hoogteverschil ahead (m)
1026	S-3_c	180,0	304,2	283,1	-3,6	-0,2	-3,3
1119	S-3_c	180,0	330,8	315,5	-2,8	-2,9	0,1
1120	S-3_c	180,0	326,3	323,5	-0,5	-0,1	-0,4
1121	S-3_c	180,0	320,4	306,4	-2,4	0,4	-2,9

Tabel 7 Mastenlijst S+0/c

Mast-nummer	Masttype	Lijnhoek (°)	Wind span (m)	Weight span (m)	Hoogteverschil ba+ah (m)	Hoogteverschil back (m)	Hoogteverschil ahead (m)
1028	S+0_c	180,0	299,0	306,9	1,2	0,3	0,9
1029	S+0_c	180,0	321,0	294,2	-5,2	-0,9	-4,3
1031	S+0_c	180,0	349,7	336,7	-2,5	-4,8	2,3
1032	S+0_c	180,0	349,7	322,4	-5,3	-2,3	-3,0
1034	S+0_c	180,0	349,7	343,5	-1,2	-0,1	-1,1
1035	S+0_c	180,0	349,7	337,6	-2,4	1,1	-3,4
1038	S+0_c	180,0	340,3	328,2	-2,4	-0,1	-2,3
1041	S+0_c	180,0	330,8	310,1	-3,5	-3,5	0,0
1042	S+0_c	180,0	359,9	343,5	-3,3	0,0	-3,2
1045	S+0_c	180,0	366,0	366,7	0,2	-0,7	0,9
1046	S+0_c	180,0	380,8	376,8	-0,8	-0,9	0,0
1047	S+0_c	180,0	380,1	383,9	0,8	0,0	0,8
1048	S+0_c	180,0	383,6	378,2	-1,1	-0,8	-0,3
1049	S+0_c	180,0	379,9	383,0	0,7	0,3	0,3

1050	S+0_c	180,0	376,5	373,7	-0,6	-0,3	-0,3
1084	S+0_c	180,0	351,1	333,2	-3,4	-3,6	0,2
1085	S+0_c	180,0	347,8	347,7	0,0	-0,2	0,2
1090	S+0_c	180,0	360,7	363,1	0,5	0,3	0,2
1091	S+0_c	180,0	377,7	376,5	-0,3	-0,2	0,0
1092	S+0_c	180,0	384,2	371,6	-2,8	0,0	-2,8
1096	S+0_c	180,0	369,6	354,3	-3,1	-2,9	-0,2
1097	S+0_c	180,0	379,2	380,5	0,3	0,2	0,0
1106	S+0_c	180,0	357,5	358,7	0,2	0,1	0,1
1107	S+0_c	180,0	361,6	359,9	-0,3	-0,1	-0,2
1108	S+0_c	180,0	389,8	390,7	0,2	0,2	0,0
1109	S+0_c	180,0	396,4	381,8	-3,2	0,0	-3,3
1112	S+0_c	180,0	384,5	385,2	0,1	-0,1	0,2
1113	S+0_c	180,0	343,8	325,6	-3,2	-0,2	-3,0
1122	S+0_c	180,0	323,2	342,9	3,5	2,9	0,6
1124	S+0_c	180,0	365,1	365,2	0,0	-0,1	0,1
1125	S+0_c	180,0	354,7	353,9	-0,2	-0,1	0,0
1126	S+0_c	180,0	365,2	366,6	0,3	0,0	0,3
1127	S+0_c	180,0	365,1	361,0	-0,8	-0,3	-0,6
1129	S+0_c	180,0	365,5	364,9	-0,1	-0,1	0,0
1132	S+0_c	180,0	233,1	224,3	-1,1	0,1	-1,2
1134	S+0_c	180,0	385,5	389,6	0,9	0,0	0,9
1135	S+0_c	180,0	385,0	379,4	-1,2	-0,9	-0,3
1136	S+0_c	180,0	376,6	377,8	0,3	0,3	-0,1
1140	S+0_c	180,0	377,5	362,5	-3,2	-3,1	-0,1
1141	S+0_c	180,0	364,9	365,2	0,1	0,1	0,0
1142	S+0_c	180,0	358,9	358,9	0,0	0,0	0,0
1143	S+0_c	180,0	361,4	361,9	0,1	0,0	0,1
1144	S+0_c	180,0	362,1	361,8	-0,1	-0,1	0,0
1145	S+0_c	180,0	362,6	363,7	0,2	0,0	0,2
1146	S+0_c	180,0	363,2	359,0	-0,9	-0,2	-0,6
1155	S+0_c	180,0	387,9	356,5	-6,8	-1,0	-5,8
1161	S+0_c	180,0	365,0	348,5	-3,5	-3,4	-0,1
1162	S+0_c	180,0	371,2	372,0	0,2	0,1	0,1
1164	S+0_c	180,0	375,1	345,1	-6,2	-0,3	-5,9
1170	S+0_c	180,0	334,4	316,3	-3,4	-3,0	-0,3
1171	S+0_c	180,0	344,2	345,2	0,2	0,3	-0,2
1172	S+0_c	180,0	369,8	371,0	0,2	0,2	0,1
1173	S+0_c	180,0	365,5	364,5	-0,2	-0,1	-0,1
1174	S+0_c	180,0	344,5	344,8	0,1	0,1	-0,1
1175	S+0_c	180,0	352,0	351,2	-0,1	0,1	-0,2
1176	S+0_c	180,0	367,5	370,2	0,6	0,2	0,3
1182	S+0_c	180,0	309,0	289,4	-3,4	-3,1	-0,3
1183	S+0_c	180,0	304,4	308,8	0,8	0,3	0,5
1189	S+0_c	180,0	339,6	339,7	0,0	0,5	-0,5
1190	S+0_c	180,0	339,6	339,4	0,0	0,5	-0,5
1191	S+0_c	180,0	337,9	339,1	0,2	0,5	-0,3
1195	S+0_c	180,0	350,4	319,9	-5,6	-5,0	-0,6
1201	S+0_c	180,0	332,4	316,4	-3,0	-3,0	0,1
1202	S+0_c	180,0	364,6	345,0	-3,6	-0,1	-3,5

Tabel 8 Mastenlijst S+3/c

Mast-nummer	Masttype	Lijnhoek (°)	Wind span (m)	Weight span (m)	Hoogteverschil ba+ah (m)	Hoogteverschil back (m)	Hoogteverschil ahead (m)
1030	S+3_c	180,0	360,7	406,3	9,1	4,3	4,8
1036	S+3_c	180,0	372,3	411,5	8,2	3,4	4,7
1039	S+3_c	180,0	342,2	362,1	3,8	2,3	1,5
1040	S+3_c	180,0	314,5	327,0	2,0	-1,5	3,5
1043	S+3_c	180,0	333,7	370,0	6,7	3,2	3,4
1070	S+3_c	180,0	325,3	320,6	-0,9	-2,5	1,6

1071	S+3_c	180,0	322,9	286,6	-6,5	-1,6	-4,9
1075	S+3_c	180,0	331,3	308,7	-2,8	2,5	-5,3
1083	S+3_c	180,0	330,9	336,4	1,2	-2,4	3,6
1093	S+3_c	180,0	399,0	410,4	2,5	2,8	-0,3
1104	S+3_c	180,0	400,0	382,2	-4,0	-6,8	2,9
1110	S+3_c	180,0	399,0	428,8	6,6	3,3	3,3
1138	S+3_c	180,0	361,9	379,0	3,5	3,5	0,0
1139	S+3_c	180,0	369,6	384,1	3,1	0,0	3,1
1160	S+3_c	180,0	385,0	416,6	6,8	3,4	3,4
1169	S+3_c	180,0	352,9	385,0	6,3	3,3	3,0
1178	S+3_c	180,0	400,0	413,5	3,0	3,3	-0,2
1179	S+3_c	180,0	400,0	399,4	-0,1	0,2	-0,4
1180	S+3_c	180,0	391,9	391,8	0,0	0,4	-0,4
1181	S+3_c	180,0	347,6	367,4	3,5	0,4	3,1
1185	S+3_c	180,0	328,1	358,3	5,0	4,7	0,3
1186	S+3_c	180,0	372,3	382,6	2,2	-0,3	2,5
1198	S+3_c	180,0	387,4	368,1	-4,3	-6,0	1,8
1200	S+3_c	180,0	362,2	388,3	5,6	2,6	3,0
1203	S+3_c	180,0	337,6	363,0	5,7	3,5	2,1

Tabel 9 Mastenlijst S+6/c

Mast-nummer	Masttype	Lijnhoek (°)	Wind span (m)	Weight span (m)	Hoogteverschil ba+ah (m)	Hoogteverschil back (m)	Hoogteverschil ahead (m)
1074	S+6_c	180,0	393,1	366,7	-5,8	-3,3	-2,5
1080	S+6_c	180,0	308,1	306,0	-0,3	-0,2	-0,2
1081	S+6_c	180,0	338,4	339,8	0,3	0,2	0,1
1082	S+6_c	180,0	316,1	329,1	2,3	-0,1	2,4
1087	S+6_c	180,0	391,0	406,8	3,2	6,1	-2,9
1100	S+6_c	180,0	399,0	411,0	2,7	3,0	-0,3
1101	S+6_c	180,0	398,6	388,5	-2,2	0,3	-2,6
1156	S+6_c	180,0	376,5	396,9	4,6	5,8	-1,3
1157	S+6_c	180,0	365,3	405,4	8,2	1,3	6,9
1165	S+6_c	180,0	367,3	397,2	6,1	5,9	0,3
1166	S+6_c	180,0	373,8	400,7	5,7	-0,3	6,0

Tabel 10 Mastenlijst S+9/c

Mast-nummer	Masttype	Lijnhoek (°)	Wind span (m)	Weight span (m)	Hoogteverschil ba+ah (m)	Hoogteverschil back (m)	Hoogteverschil ahead (m)
1072	S+9_c	180,0	361,6	386,6	4,4	4,9	-0,5
1073	S+9_c	180,0	400,0	416,8	3,7	0,5	3,3
1088	S+9_c	180,0	382,7	439,7	11,8	2,9	9,0
1102	S+9_c	180,0	399,5	405,3	1,3	2,6	-1,3
1103	S+9_c	180,0	400,0	436,5	8,1	1,3	6,8
1193	S+9_c	180,0	333,3	403,8	12,3	9,5	2,9
1197	S+9_c	180,0	270,7	328,7	9,3	9,7	-0,4

Tabel 11 Mastenlijst S+12/c

Mast-nummer	Masttype	Lijnhoek (°)	Wind span (m)	Weight span (m)	Hoogteverschil ba+ah (m)	Hoogteverschil back (m)	Hoogteverschil ahead (m)
1076	S+12_c	180,0	337,8	379,1	6,8	5,3	1,6
1077	S+12_c	180,0	399,1	418,2	4,2	-1,6	5,8
1115	S+12_c	180,0	269,8	355,0	10,2	9,6	0,6
1116	S+12_c	180,0	364,0	362,0	-0,3	-0,6	0,2
1117	S+12_c	180,0	398,1	451,4	11,8	-0,2	12,0

3.4 Geleiderbelastingen

De berekening is uitgevoerd met het geleiderbelastingprogramma van DNV GL. De belastingen op de mastconstructie zijn bepaald op basis van de modellering in PLS-TOWER (staafoppervlaktes). Voor de toeslagen op eigen gewicht en windoppervlakte wordt verwezen naar het uitgangspuntenrapport. In Appendix A zijn de resultaten van de geleiderbelastingen samengevat.

3.5 Reacties op de fundering

De oplegreacties op de fundering worden ontleend aan de uitvoer van het geleiderbelastingprogramma. Zie Appendix A.

3.6 Modelling

Op basis van de ontwerptekeningen is de mast in PLS-TOWER ingevoerd. De toetsing wordt per staafgroep uitgevoerd. De hoofdelementen zijn gemodelleerd, niet-dragende profielen als knikverkorters zijn weggelaten, deze worden separaat getoetst. De profielen zijn in PLS-TOWER inclusief de boutverbindingen ingevoerd en getoetst, de controle van de schetsplaten en andere detailverbindingen valt buiten de scope.

De geleiderbelastingen vanuit het geleiderbelastingprogramma zijn als invoer voor de belastingen gebruikt.

De gewichts- en windbelasting op de mastconstructie wordt door PLS-TOWER automatisch bepaald. Via toeslagfactoren wordt de invloed van niet gemodelleerde elementen als knikverkorters, bordesconstructies en klimvoorzieningen meegenomen. Voor schetsplaten, zinklaag en bouten is een aanvullende toeslag op het gewicht van 15% (*steunmast*) / 20% (*hoekmast*) toeslag gerekend.

Diagonalen in voor- en achtervlak respectievelijk de twee zijvlakken zijn samengenomen in een groep.

3.7 Overige controles

In PLS-TOWER zijn niet alle elementen getoetst. Knikverkortersprofielen en overige profielen voor beloopbaarheid worden separaat getoetst. In Appendix C is dit opgenomen. De verbinding met de fundatie bestaat uit ingestorte profielen voorzien van blokdeuvels. Dit is in Appendix D opgenomen. De liggers van isolatorkettingen vereisen een aanvullende controle op buiging. De toetsing is uitgevoerd met de software AxisVM en is beschreven in Appendix E. Appendix F omvat de toetsing op sterkte-coördinatie.

3.8 Mastgewicht

Het totale mastgewicht per masttype is met de uitgangspunten van paragraaf 3.6 bepaald op:

- Masttype S-3/c 42,6 ton
- Masttype S+0/c 45,0 ton
- Masttype S+3/c 46,7 ton
- Masttype S+6/c 49,2 ton
- Masttype S+9/c 52,2 ton
- Masttype S+12/c 59,2 ton

4 TOETSING

4.1 Resultaat PLS-TOWER

Het resultaat van de toetsing met PLS-TOWER is per masttype weergegeven in onderstaande Figuur 2. Voor elk masttype zijn de belastingen apart bepaald. Alléén voor masttype S+12/c, bepalend voor het ontwerp van de mastkop, zijn deze ook inclusief bouwphase (enkelzijdig belast) en hijslasten.

De uitnutting van de constructie loopt op van blauw (0-25%) tot geel (75-100%). Uit de figuur wordt geconcludeerd dat alle profielen en boutverbindingen voldoen.

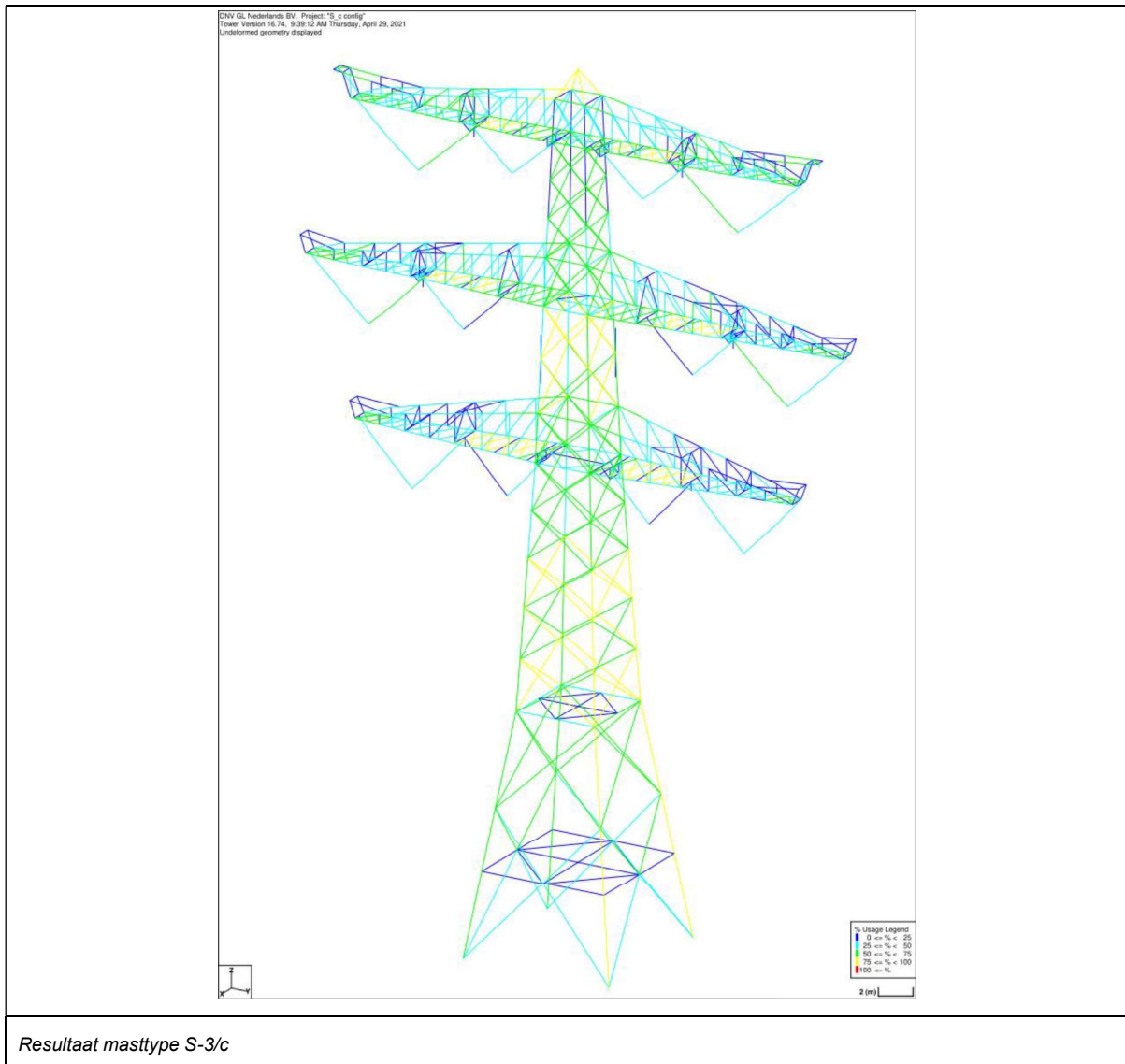

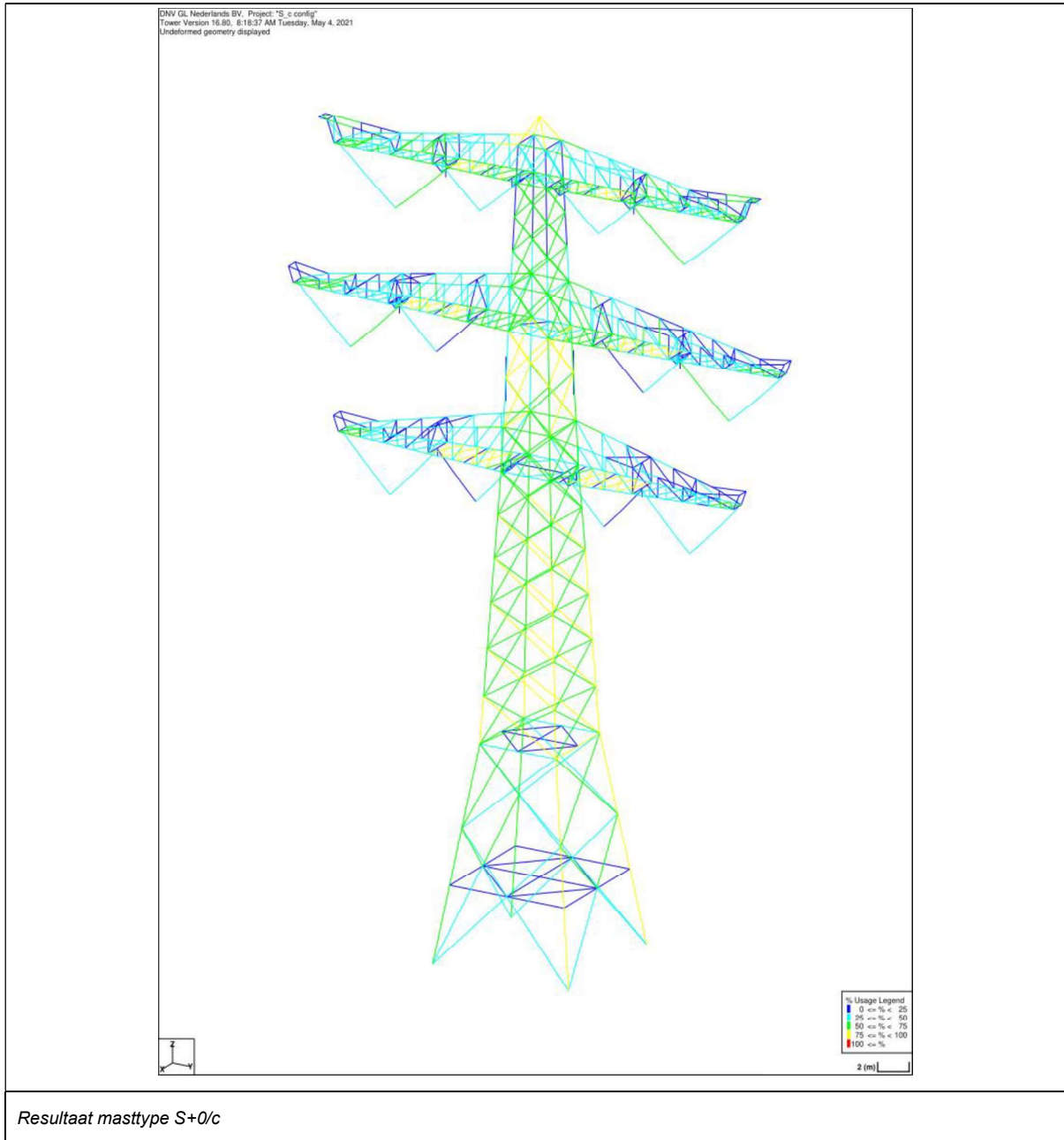

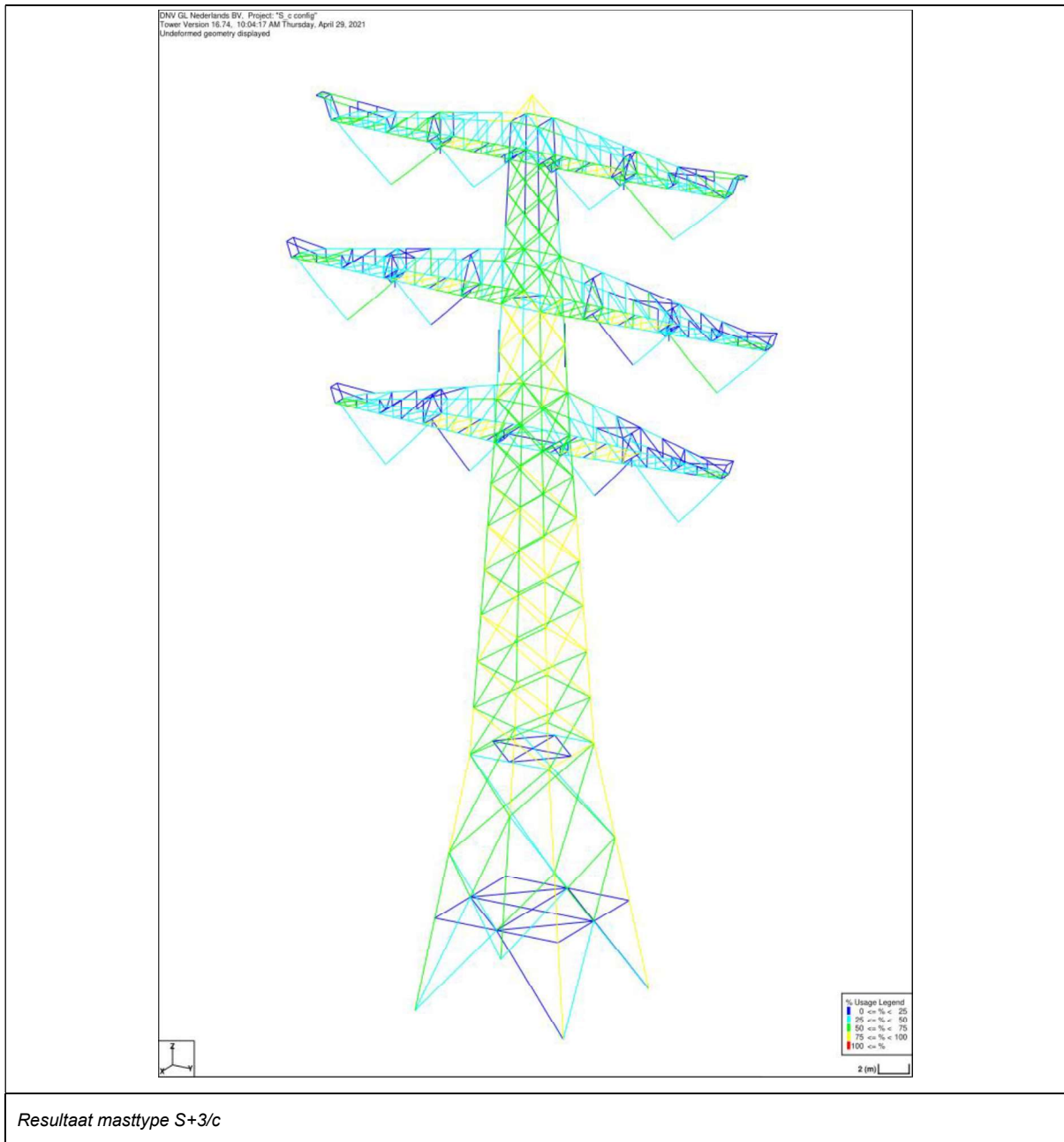

DNV GL Nederlands BV, Project: "S_c config"
Tower Version 16.74, 10:04:17 AM Thursday, April 29, 2021
Undeformed geometry displayed

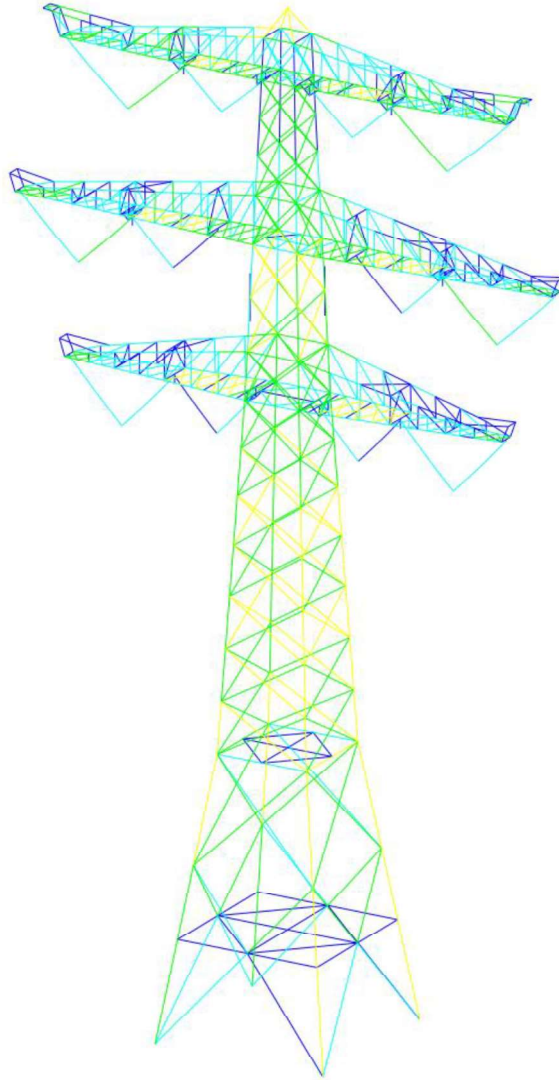

% Usage Legend
0 ≤ % < 25
25 ≤ % < 50
50 ≤ % < 75
75 ≤ % < 100
100 ≤ %

2 (m)

Resultaat masttype S+6/c

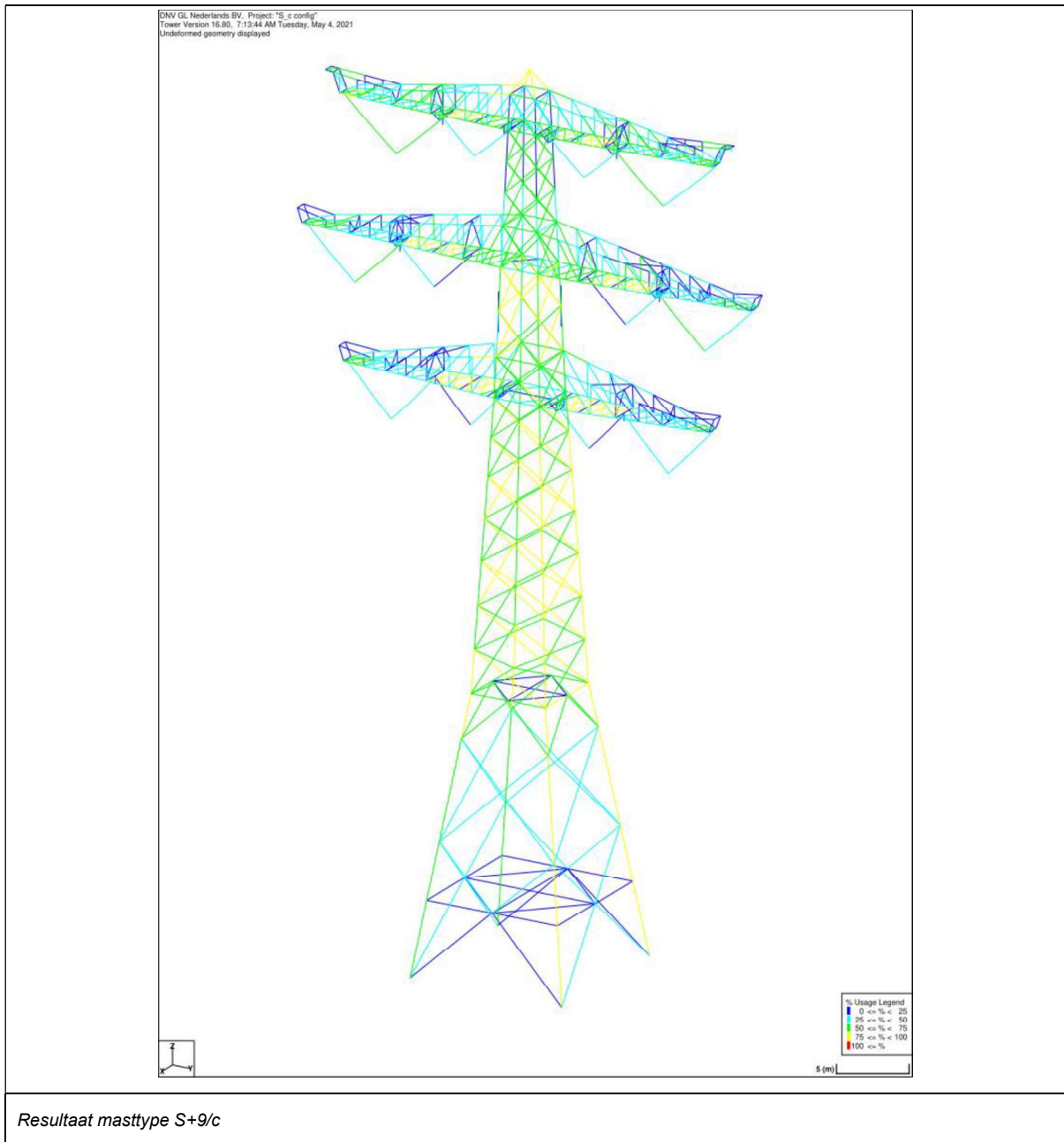

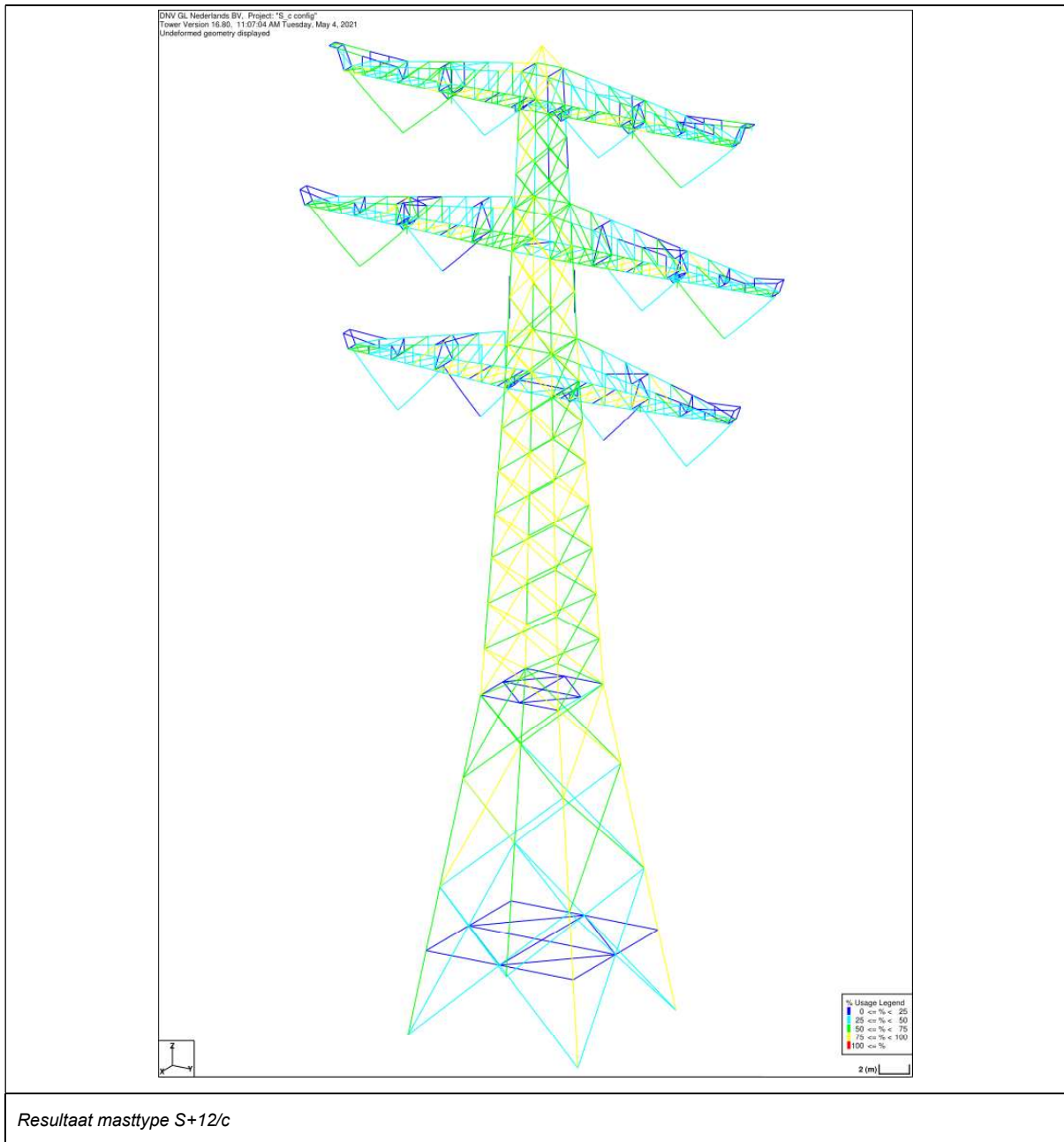

Figuur 2 Resultaat PLS-TOWER voor masttype S-3/c t/m S+12/c

4.2 Toetsing overige onderdelen

In Tabel 12 zijn de resultaten van de uitgevoerde toetsingen weergegeven.

Tabel 12 Samenvatting uitgevoerde controles

Controle van	Beoordeling	Referentie
Profielen	Voldoen	Figuur 2 Appendix B
Knikverkorters	Voldoen	Appendix C
Blokdeuvels randstijl	Voldoen	Appendix D
Liggers	Voldoen	Appendix E
Sterkte-coördinatie	Voldoet	Appendix F

APPENDIX A

Geleiderbelastingen

Geleiderbelastingen opgenomen:

- Masttype S-3/c
- Masttype S+0/c
- Masttype S+3/c
- Masttype S+6/c
- Masttype S+9/c
- Masttype S+12/c
- Masttype S+12/c bouwfase
- Hijslast liggers

Project: RLL-TLB380
Tower: S-3_c
Number: 1119

Auteur: TBR
Versie: v11.8

Geleiderbelastingen

Algemeen

Benaming S-3_c
Masttype Steunmast
Aantal circuits 4
Configuratie 4-circuit-dubbel verticaal
Aantal bliksemgeleiders 2

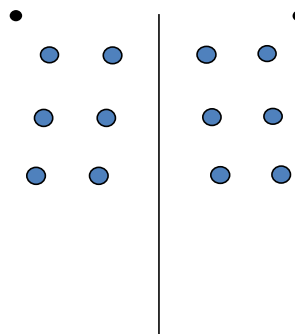

Configuratie geleiders

Uitgangspunten

Norm NEN-EN50341-2-15:2019
Gevolgklasse initieel CC2
Betrouwbaarheidsniveau initieel Nieuwbouw
Referentieperiode initieel 50 jaar
Betrouwbaarheidsniveau na aanpassing n.v.t.
50 jaar
Windgebied III
Windsnelheid (m/s) 24,5 m/s
Terreincategorie II
Reductiefactor c_{dir} 1,00
IJsgebied fasegeleider B
IJsgebied bliksemgeleider A

Geleiders Back

Omschrijving	Spanning	Geleider Back	Bundel Ba	IJsgebied	Toeslag gewicht	Toeslag diameter	Intrekwaarden P_{back}
Circuit 1	380 kV	AAAC-AL7 620	4	B	3 %	3 %	1800
Circuit 2	380 kV	AAAC-AL7 620	4	B	3 %	3 %	1800
Circuit 3	150 kV	AAAC-AL7 620	2	B	3 %	3 %	1800
Circuit 4	150 kV	AAAC-AL7 620	2	B	3 %	3 %	1800
Bliksemdraad 1		AACSR 241-AL3-39-A20SA	1	A	2 %	2 %	1800
Bliksemdraad 2		OPGW AFL-226/38	1	A	2 %	2 %	1800

Geleiders Ahead

Omschrijving	Spanning	Geleider Ahead	Bundel Ah	IJsgebied	Toeslag gewicht	Toeslag diameter	Intrekwaarden P_{ahead}
Circuit 1	380 kV	AAAC-AL7 620	4	B	3 %	3 %	1800
Circuit 2	380 kV	AAAC-AL7 620	4	B	3 %	3 %	1800
Circuit 3	150 kV	AAAC-AL7 620	2	B	3 %	3 %	1800
Circuit 4	150 kV	AAAC-AL7 620	2	B	3 %	3 %	1800
Bliksemdraad 1		AACSR 241-AL3-39-A20SA	1	A	2 %	2 %	1800
Bliksemdraad 2		OPGW AFL-226/38	1	A	2 %	2 %	1800

Isolatoren (1)

Omschrijving	Ophanging	Gewicht [kN]	Lengte [m]	Windopp. [m ²]
Circuit 1	V-ketting	4,50	4,50	2,00
Circuit 2	V-ketting	4,50	4,50	2,00
Circuit 3	V-ketting	2,50	4,00	1,00
Circuit 4	V-ketting	2,50	4,00	1,00
Bliksemdraad 1	Vast (Bliksemdraad)	0,10	0,20	0,10
Bliksemdraad 2	Vast (Bliksemdraad)	0,10	0,20	0,10

1. Eigenschappen gelden voor geheel van de isolatorset

Ophanghoogte en positie in mast

Circuits	Aanduiding	Nummer	Ophanghoogte	Aangrippunt	Positie in mast Horizontale afstand
Circuit 1	10	380ct1f1	25,4 m	29,9 m	11,3 m
Circuit 1	11	380ct1f2	34,9 m	39,4 m	14,0 m
Circuit 1	12	380ct1f3	44,9 m	49,4 m	10,3 m
Circuit 2	20	380ct2f1	25,4 m	29,9 m	-11,3 m
Circuit 2	21	380ct2f2	34,9 m	39,4 m	-14,0 m
Circuit 2	22	380ct2f3	44,9 m	49,4 m	-10,3 m
Circuit 3	30	150ct3f1	25,9 m	29,9 m	5,0 m
Circuit 3	31	150ct3f2	35,4 m	39,4 m	7,7 m
Circuit 3	32	150ct3f3	45,4 m	49,4 m	4,0 m
Circuit 4	40	150ct4f1	25,9 m	29,9 m	-5,0 m
Circuit 4	41	150ct4f2	35,4 m	39,4 m	-7,7 m
Circuit 4	42	150ct4f3	45,4 m	49,4 m	-4,0 m
Bliksemdraad 1	1	bl1	49,9 m	50,1 m	14,8 m
Bliksemdraad 2	3	bl2	49,9 m	50,1 m	-14,8 m

Project: RLL-TLB380
 Tower: S-3_c
 Number: 1119

Hoogteaanpassing naastgelegen masten (aanpassing wind- en weight span)

	Back	Ahead	
Verhoging voor windbelasting	6,0 m	6,0 m	(positief: omhoog)
Verlaging voor verticale belasting	-6,0 m	-6,0 m	(negatief: omlaag, grotere weight span)
Verlaging:	Niet in 0,9EG-combinaties		

Hoogteafwijking mastbeeld naastgelegen masten en richtingsverandering t.o.v. Lijnrichting

Circuits	Aanduiding	Nummer	Hoogteverschil		Richtingsverandering	
			Δh_{back}	Δh_{ahead}	Δy_{back}	Δy_{ahead}
Circuit 1	10	380ct1f1	0,0	0,0 m	0,0	0,0 m
Circuit 1	11	380ct1f2	0,0	0,0 m	0,0	0,0 m
Circuit 1	12	380ct1f3	0,0	0,0 m	0,0	0,0 m
Circuit 2	20	380ct2f1	0,0	0,0 m	0,0	0,0 m
Circuit 2	21	380ct2f2	0,0	0,0 m	0,0	0,0 m
Circuit 2	22	380ct2f3	0,0	0,0 m	0,0	0,0 m
Circuit 3	30	150ct3f1	0,0	0,0 m	0,0	0,0 m
Circuit 3	31	150ct3f2	0,0	0,0 m	0,0	0,0 m
Circuit 3	32	150ct3f3	0,0	0,0 m	0,0	0,0 m
Circuit 4	40	150ct4f1	0,0	0,0 m	0,0	0,0 m
Circuit 4	41	150ct4f2	0,0	0,0 m	0,0	0,0 m
Circuit 4	42	150ct4f3	0,0	0,0 m	0,0	0,0 m
Bliksemendraad 1	1	bl1	0,0	0,0 m	0,0	0,0 m
Bliksemendraad 2	3	bl2	0,0	0,0 m	0,0	0,0 m

Lijn- en mastgegevens

	Back	Ahead
Ruling span $\sqrt{(\Sigma L^3/\Sigma L)}$	400,0	400,0 m
Lijnhoek	180 °	
Rotatie mast t.o.v. bissectrice	θ	0 °
Vaklengte	800	800 m
Hoogte onderkant mast t.o.v. maaiveld	0,5 m	
Beschouwde windrichtingen	α_1	0 °
Windrichtingen volgens:	α_2	45 °
<i>Geleiderbelastingen</i>	α_3	90 °
	α_4	135 °
	α_5	- °
	α_6	- °

Windrichtingen gelden t.o.v. hoofdrichting mastconstructie, niet t.o.v. bissectrice.

Windrichtingen en positieve richtingen belastingen

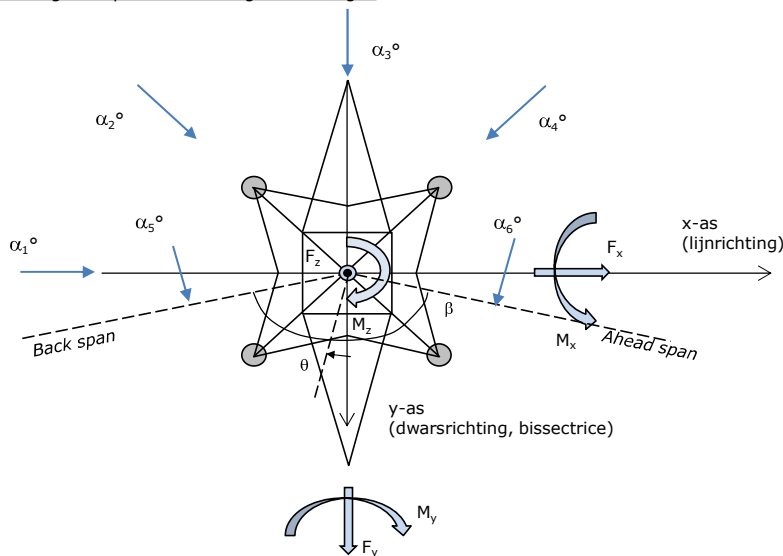

Beschouwd aantal windrichtingen	
1a	4
3	4
4	1
6	1
Overig	1

Project: RLL-TLB380
 Tower: S-3_c
 Number: 1119

Geleiderafval

		SPLS - torsie		SPLS - Enkelzijdige trek		5a - geleiderbreuk	
		Aanw.	Afw.	Aanw.	Afw.	Aanw.	Afw.
Circuit 1	380ct1f1	1	0	1	0	0,8	0
Circuit 1	380ct1f2	1	0	1	0	0,8	0
Circuit 1	380ct1f3	1	0	1	0	0,8	0
Circuit 2	380ct2f1	0	1	1	0	0,8	0
Circuit 2	380ct2f2	0	1	1	0	0,8	0
Circuit 2	380ct2f3	0	1	1	0	0,8	0
Circuit 3	150ct3f1	1	0	1	0	0,8	0
Circuit 3	150ct3f2	1	0	1	0	0,8	0
Circuit 3	150ct3f3	1	0	1	0	0,8	0
Circuit 4	150ct4f1	0	1	1	0	0,8	0
Circuit 4	150ct4f2	0	1	1	0	0,8	0
Circuit 4	150ct4f3	0	1	1	0	0,8	0
Bliksemdraad 1	b1	1	0	1	0	1	0
Bliksemdraad 2	b2	0	1	1	0	1	0

Belastingsituaties SPLS

Beschouwde situaties SPLS: SPLS voor steunmast niet van toepassing

Principe belastingssituaties:

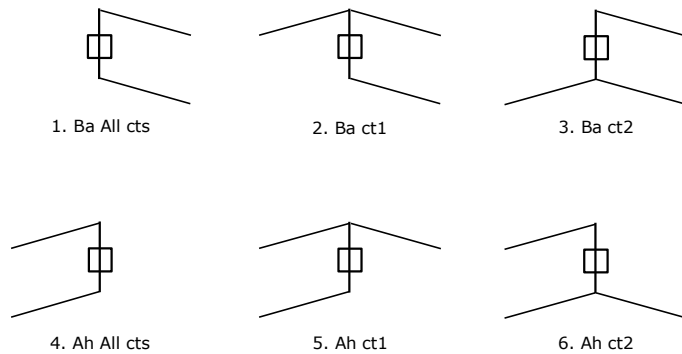

Belastingsituaties 5a. Geleiderbreuk

Beschouwde situaties geleiderbreuk 5a: 1 en 2, alle mogelijke situaties.

Principe belastingssituaties:

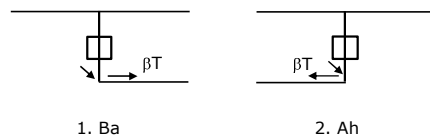

Project: RLL-TLB380
 Tower: S-3_c
 Number: 1119

Belastingsituaties 6. Bouw- en onderhoud

Onder 6a wordt de belasting door aanwezigheid lijnwagen of lijnfiets in combinatie met puntlast op traverse in rekening gebracht. Combinatie 6b bevat geen belastingen in geleider of op traverse. Deze combinatie is toegevoegd om te kunnen combineren met separate controle bordessen etc. De situaties worden in ULS en in iedere SPLS-situatie (in geval van hoekmast) toegepast.

	Fase	Bliksem
Lijnwagen	4,0 kN	2,0 kN
Puntlast op traverse	1,0 kN	1,0 kN

Beschouwde situaties bouw- en onderhoud 6a: 1 t/m 4, alle mogelijke situaties.

Aanwezigheid lijnwagen: Circuit, belasting tegelijk aanwezig in alle geleiders per circuit.

Principe belastingssituaties:

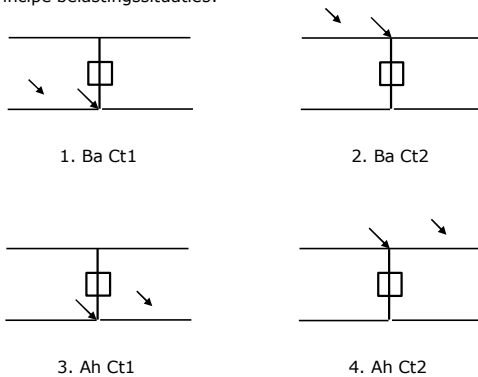

Belastingsituaties 8. Lijndansen als statische belasting

Geleider		
Steunmast fase	0,866 W	1,5 W
Steunmast bliksem	1,5 EDS	1,5 W
Hoekmast fase en bliksem	1,5 EDS	1,5 W

Considered situations galloping 8: 1 and 2, all possible situations

Belasting tegelijk aanwezig in alle geleiders van het circuit.

Principe belastingssituaties:

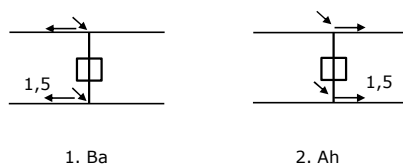

Belastingcombinatie 8. Lijndansen als dynamische belasting

Alleen van toepassing op hoek- en eindmasten

Belasting bestaat uit EDS-trekbelasting in één van de geleiders aan één zijde van de mast

Door gebruiker via het belastingsspectrum van tabel 4.11/NL.1 om te zetten naar spanningspectrum

Project: RLL-TLB380
 Tower: S-3_c
 Number: 1119

Mastconstructie

Eigenschappen

Masttype	Steunmast	
Mastbenaming	S-3_c	
Voetplaat t.o.v. maaiveld	0,5 m	
Masthoogte t.o.v. voetplaat	53,7 m	
Gewicht mast	418,0 kN	
<i>Breedte en helling mast bij fundatie</i>	x-ri.	y-ri.
Pootsprei	9,67	9,67 m
Helling van de randstijl	0,150	0,150 -
Factor spatkracht	1,1	1,1 -

Berekening windbelasting

Dynamische invloed G_T	1,00 (<i>Masthoogte < 60 m</i>)
Windbelasting overhoeks op mastlichaam evenredig met:	$(A1C1\sin^2(\phi)+A2C2\cos^2(\phi))$
Windbelasting overhoeks op traverse evenredig met:	$(A1C1\sin^2(\phi)+A2C2\cos^2(\phi))$
Vergroting wind overhoeks mastlichaam	$(1+0,2\sin^2(2\phi))$
Vergroting wind overhoeks traverse	$(1+0,2\sin^2(2\phi))$
Factor wind evenwijdig t.o.v. haaks op traverse	0,4

Eigenschappen mastsecties langsrichting (vooraanzicht, yz-vlak)

Omschrijving	h [m]	b ₁ [m]	b ₂ [m]	Δh [m]	Δ _x [m]	A ₀ [m ²]	A ₁ [m ²]	χ = A ₁ /A ₀ [-]	C _t
Broekstuk	14,80	9,67	5,23	14,80	0,150	110,27	18,67	0,17	3,07
Eerste tussenstuk	21,10	5,23	4,55	6,30	0,054	30,81	6,61	0,21	2,87
Tweede tussenstuk	29,90	4,55	3,60	8,80	0,054	35,86	10,13	0,28	2,60
Bovenstuk 1	39,40	3,60	2,92	9,50	0,036	30,97	9,99	0,32	2,46
Bovenstuk 2	52,00	2,92	2,01	12,60	0,036	31,06	9,61	0,31	2,50
Topstuk	53,70	2,01		1,70		1,71	0,32	0,18	3,00
Ondertraverse	29,90	12,70		3,00		19,05	4,75	0,25	2,72
Middentraverse	39,40	16,34		3,00		24,51	6,81	0,28	2,62
Boventraverse	49,40	13,70	1,00	2,60		24,66	6,19	0,25	2,72

Eigenschappen mastsecties dwarsrichting (zijaanzicht, xz-vlak)

Omschrijving	h [m]	b ₁ [m]	b ₂ [m]	Δh [m]	Δ _x [m]	A ₀ [m ²]	A ₁ [m ²]	χ = A ₁ /A ₀ [-]	C _t
Broekstuk	14,80	9,67	5,23	14,80	0,150	110,27	18,67	0,17	3,07
Eerste tussenstuk	21,10	5,23	4,55	6,30	0,054	30,81	6,61	0,21	2,87
Tweede tussenstuk	29,90	4,55	3,60	8,80	0,054	35,86	10,13	0,28	2,60
Bovenstuk 1	39,40	3,60	2,92	9,50	0,036	30,97	9,99	0,32	2,46
Bovenstuk 2	52,00	2,92	2,01	12,60	0,036	31,06	9,61	0,31	2,50
Topstuk	53,70	2,01		1,70		1,71	0,32	0,18	3,00
Ondertraverse	29,90	12,70		3,00		19,05	4,75	0,25	2,72
Middentraverse	39,40	16,34		3,00		24,51	6,81	0,28	2,62
Boventraverse	49,40	13,70	1,00	2,60		24,66	6,19	0,25	2,72

NB: oppervlakte traverse dwarsrichting wordt in berekening gereduceerd.

Project: RLL-TLB380
 Tower: S-3_c
 Number: 1119

Windoppervlak feeders telecominstallaties

Onderdeel	A (m ² /m)	Factor	Δh	A ₁
Broekstuk	0,14	0,71	14,8	1,5
Eerste tussenstuk	0,14	0,71	6,3	0,6
Tweede tussenstuk	0,14	0,71	8,8	0,9
Bovenstuk 1	0,14	0,71	9,5	0,9
Bovenstuk 2				

Invoer antennes

Omschrijving	A (m ²)	h (m)	C _r (m)
Antenne top			
Antenne o.t.	4,7	36,2	1,5

Belastingen mastsectie langsrichting (x-richting) per windrichting

Omschrijving	P _w [kN/m ²]	F _{x1} [kN]	F _{x2} [kN]	F _{x3} [kN]	F _{x4} [kN]	h _{ef} [m]	M _{y1} [kNm]	M _{y2} [kNm]	M _{y3} [kNm]	M _{y4} [kNm]
Broekstuk	0,70	40,2	34,1	0,0	-34,1	7,4	297,2	252,2	0,0	-252,2
Eerste tussenstuk	0,85	16,1	13,7	0,0	-13,7	18,0	289,1	245,3	0,0	-245,3
Tweede tussenstuk	0,94	24,8	21,1	0,0	-21,1	25,5	633,1	537,2	0,0	-537,2
Bovenstuk 1	1,03	25,3	21,5	0,0	-21,5	34,7	878,2	745,2	0,0	-745,2
Bovenstuk 2	1,11	26,7	22,6	0,0	-22,6	45,7	1218,6	1034,0	0,0	-1034,0
Topstuk	1,15	1,1	0,9	0,0	-0,9	52,9	57,7	48,9	0,0	-48,9
Ondertraverse	1,00	25,8	15,3	0,0	-15,3	30,9	797,6	473,7	0,0	-473,7
Middentraverse	1,07	38,2	22,7	0,0	-22,7	40,4	1544,5	917,4	0,0	-917,4
Boventraverse	1,14	38,3	22,7	0,0	-22,7	50,3	1923,7	1142,6	0,0	-1142,6
Totaal		236,5	174,6	0,0	-174,6		7639,7	5396,6	0,0	-5396,6

Belastingen mastsectie dwarsrichting (y-richting) per windrichting

Omschrijving	P _w [kN/m ²]	F _{y1} [kN]	F _{y2} [kN]	F _{y3} [kN]	F _{y4} [kN]	h _{ef} [m]	M _{x1} [kNm]	M _{x2} [kNm]	M _{x3} [kNm]	M _{x4} [kNm]
Broekstuk	0,70	0,0	34,1	40,2	34,1	7,4	0,0	252,2	297,2	252,2
Eerste tussenstuk	0,85	0,0	13,7	16,1	13,7	18,0	0,0	245,3	289,1	245,3
Tweede tussenstuk	0,94	0,0	21,1	24,8	21,1	25,5	0,0	537,2	633,1	537,2
Bovenstuk 1	1,03	0,0	21,5	25,3	21,5	34,7	0,0	745,2	878,2	745,2
Bovenstuk 2	1,11	0,0	22,6	26,7	22,6	45,7	0,0	1034,0	1218,6	1034,0
Topstuk	1,15	0,0	0,9	1,1	0,9	52,9	0,0	48,9	57,7	48,9
Ondertraverse	1,00	0,0	15,3	10,3	15,3	30,9	0,0	473,7	319,0	473,7
Middentraverse	1,07	0,0	22,7	15,3	22,7	40,4	0,0	917,4	617,8	917,4
Boventraverse	1,14	0,0	22,7	15,3	22,7	50,3	0,0	1142,6	769,5	1142,6
Totaal		0,0	174,6	175,1	174,6		0,0	5396,6	5080,2	5396,6

Resulterende belastingen vanuit mastconstructie incl. antenne zonder geleiders niveau fundatie (kar. waarde)

Belasting / windrichting	F _x	F _y	F _z	M _x	M _y	M _z
	[kN]	[kN]	[kN]	[kNm]	[kNm]	[kNm]
Permanente belasting	0	0	418	0	0	0
Windrichting 0°	244	0	0	0	7905	0
Windrichting 45°	180	180	0	5585	5585	0
Windrichting 90°	0	182	0	5346	0	0
Windrichting 135°	-180	180	0	5585	-5585	0

Project: RLL-TLB380
 Tower: S-3_c
 Number: 1119

Tussenresultaten geleiderbelastingen

Geleiders back

Circuit	Geleider	Diameter [mm]	A [mm ²]	G [N/m]	E [N/mm ²]	αT [-]
Circuit 1	AAAC-AL7 620	32,4	621,0	17,71	56000	2,30E-05
Circuit 2	AAAC-AL7 620	32,4	621,0	17,71	56000	2,30E-05
Circuit 3	AAAC-AL7 620	32,4	621,0	17,71	56000	2,30E-05
Circuit 4	AAAC-AL7 620	32,4	621,0	17,71	56000	2,30E-05
Bliksemdraad 1	AACSR 241-AL3-39-A20SA	21,8	281,0	9,38	70165	1,97E-05
Bliksemdraad 2	OPGW AFL-226/38	21,7	264,0	9,13	72000	1,98E-05

Geleiders ahead

Circuit	Geleider	Diameter [mm]	A [mm ²]	G [N/m]	E [N/mm ²]	αT [-]
Circuit 1	AAAC-AL7 620	32,4	621,0	17,71	56000	2,30E-05
Circuit 2	AAAC-AL7 620	32,4	621,0	17,71	56000	2,30E-05
Circuit 3	AAAC-AL7 620	32,4	621,0	17,71	56000	2,30E-05
Circuit 4	AAAC-AL7 620	32,4	621,0	17,71	56000	2,30E-05
Bliksemdraad 1	AACSR 241-AL3-39-A20SA	21,8	281,0	9,38	70165	1,97E-05
Bliksemdraad 2	OPGW AFL-226/38	21,7	264,0	9,13	72000	1,98E-05

Verticale belasting back

Circuit	Bundel [-]	Toeslag [%]	$w_{z,G}$ [N/m]	IJsg gebied	Formule	$w_{z,ijs}$ [N/m]	$w_{z,ijs,bundel}$ [N/m]
Circuit 1	4	3	73,0		B 4+0,2d	10,5	41,9
Circuit 2	4	3	73,0		B 4+0,2d	10,5	41,9
Circuit 3	2	3	36,5		B 4+0,2d	10,5	21,0
Circuit 4	2	3	36,5		B 4+0,2d	10,5	21,0
Bliksemdraad 1	1	2	9,6		A 15+0,4d	23,7	23,7
Bliksemdraad 2	1	2	9,3		A 15+0,4d	23,7	23,7

Verticale belasting ahead

Circuit	Bundel [-]	Toeslag [%]	$w_{z,G}$ [N/m]	IJsg gebied	Formule	$w_{z,ijs}$ [N/m]	$w_{z,ijs,bundel}$ [N/m]
Circuit 1	4	3	73,0		B 4+0,2d	10,5	41,9
Circuit 2	4	3	73,0		B 4+0,2d	10,5	41,9
Circuit 3	2	3	36,5		B 4+0,2d	10,5	21,0
Circuit 4	2	3	36,5		B 4+0,2d	10,5	21,0
Bliksemdraad 1	1	2	9,6		A 15+0,4d	23,7	23,7
Bliksemdraad 2	1	2	9,3		A 15+0,4d	23,7	23,7

Isolatoren

Geleider	$G_{isolator}$ [kN]	Aantal	$F_{V,iso}$ [kN]	Lengte [m]	Windopp. [m ²]	Windhoogte [m]	Stuwdruk [kN/m ²]	Vormfactor	$F_{th,iso}$ [kN]
380ct1f1	4,50	1	4,5	4,5	2,0	28,15	0,97	1,2	2,33
380ct1f2	4,50	1	4,5	4,5	2,0	37,65	1,05	1,2	2,53
380ct1f3	4,50	1	4,5	4,5	2,0	47,65	1,12	1,2	2,69
380ct2f1	4,50	1	4,5	4,5	2,0	28,15	0,97	1,2	2,33
380ct2f2	4,50	1	4,5	4,5	2,0	37,65	1,05	1,2	2,53
380ct2f3	4,50	1	4,5	4,5	2,0	47,65	1,12	1,2	2,69
150ct3f1	2,50	1	2,5	4,0	1,0	28,40	0,97	1,2	1,17
150ct3f2	2,50	1	2,5	4,0	1,0	37,90	1,05	1,2	1,27
150ct3f3	2,50	1	2,5	4,0	1,0	47,90	1,12	1,2	1,35
150ct4f1	2,50	1	2,5	4,0	1,0	28,40	0,97	1,2	1,17
150ct4f2	2,50	1	2,5	4,0	1,0	37,90	1,05	1,2	1,27
150ct4f3	2,50	1	2,5	4,0	1,0	47,90	1,12	1,2	1,35
bl1	0,10	1	0,1	0,2	0,1	50,50	1,14	1,2	0,14
bl2	0,10	1	0,1	0,2	0,1	50,50	1,14	1,2	0,14

Project: RLL-TLB380
 Tower: S-3_c
 Number: 1119

Windbelasting back

Geleider	hoogte		G _{c,dwars}	G _{c,trek}	C _c	d _{toeslag}	W _y	W _{y,vak}	D _{ijs,toeslag}	W _{y,ijs}	W _{y,ijs,vak}
	wind	Stuwdruk									
	[m]	[kN/m ²]	[-]	[-]	[-]	[mm]	[N/m]	[N/m]	[mm]	[N/m]	[N/m]
380ct1f1	21,5	0,90	0,55	0,55	1,04	33,37	68,4	68,4	51,8	122,9	122,9
380ct1f2	31,0	1,00	0,58	0,58	1,00	33,37	77,4	77,4	51,8	143,9	143,9
380ct1f3	41,0	1,08	0,60	0,60	0,98	33,37	84,6	84,6	51,8	161,3	161,3
380ct2f1	21,5	0,90	0,55	0,55	1,04	33,37	68,4	68,4	51,8	122,9	122,9
380ct2f2	31,0	1,00	0,58	0,58	1,00	33,37	77,4	77,4	51,8	143,9	143,9
380ct2f3	41,0	1,08	0,60	0,60	0,98	33,37	84,6	84,6	51,8	161,3	161,3
150ct3f1	22,0	0,90	0,55	0,55	1,03	33,37	34,5	34,5	51,8	62,1	62,1
150ct3f2	31,5	1,00	0,58	0,58	1,00	33,37	38,9	38,9	51,8	72,4	72,4
150ct3f3	41,5	1,08	0,60	0,60	0,98	33,37	42,5	42,5	51,8	81,0	81,0
150ct4f1	22,0	0,90	0,55	0,55	1,03	33,37	34,5	34,5	51,8	62,1	62,1
150ct4f2	31,5	1,00	0,58	0,58	1,00	33,37	38,9	38,9	51,8	72,4	72,4
150ct4f3	41,5	1,08	0,60	0,60	0,98	33,37	42,5	42,5	51,8	81,0	81,0
bl1	46,0	1,11	0,61	0,61	1,19	22,24	18,0	18,0	63,1	51,4	51,4
bl2	46,0	1,11	0,61	0,61	1,19	22,13	17,9	17,9	63,0	51,3	51,3

Windbelasting ahead

Geleider	hoogte		G _{c,dwars}	G _{c,trek}	C _c	d _{toeslag}	W _y	W _{y,vak}	D _{ijs,toeslag}	W _{y,ijs}	W _{y,ijs,vak}
	wind	Stuwdruk									
	[m]	[kN/m ²]	[-]	[-]	[-]	[mm]	[N/m]	[N/m]	[mm]	[N/m]	[N/m]
380ct1f1	21,5	0,90	0,55	0,55	1,04	33,37	68,4	68,4	51,8	122,9	122,9
380ct1f2	31,0	1,00	0,58	0,58	1,00	33,37	77,4	77,4	51,8	143,9	143,9
380ct1f3	41,0	1,08	0,60	0,60	0,98	33,37	84,6	84,6	51,8	161,3	161,3
380ct2f1	21,5	0,90	0,55	0,55	1,04	33,37	68,4	68,4	51,8	122,9	122,9
380ct2f2	31,0	1,00	0,58	0,58	1,00	33,37	77,4	77,4	51,8	143,9	143,9
380ct2f3	41,0	1,08	0,60	0,60	0,98	33,37	84,6	84,6	51,8	161,3	161,3
150ct3f1	22,0	0,90	0,55	0,55	1,03	33,37	34,5	34,5	51,8	62,1	62,1
150ct3f2	31,5	1,00	0,58	0,58	1,00	33,37	38,9	38,9	51,8	72,4	72,4
150ct3f3	41,5	1,08	0,60	0,60	0,98	33,37	42,5	42,5	51,8	81,0	81,0
150ct4f1	22,0	0,90	0,55	0,55	1,03	33,37	34,5	34,5	51,8	62,1	62,1
150ct4f2	31,5	1,00	0,58	0,58	1,00	33,37	38,9	38,9	51,8	72,4	72,4
150ct4f3	41,5	1,08	0,60	0,60	0,98	33,37	42,5	42,5	51,8	81,0	81,0
bl1	46,0	1,11	0,61	0,61	1,19	22,24	18,0	18,0	63,1	51,4	51,4
bl2	46,0	1,11	0,61	0,61	1,19	22,13	17,9	17,9	63,0	51,3	51,3

Project: RLL-TLB380
 Masttype: S-3_c
 Mast: 1119

Auteur: TBR
 Versie: v11.8

Geleiderbelastingen

Uitgangspunten
 Betrouwbaarheidsniveau Nieuwbouw CC2
 Referentieperiode 50 jaar

ULS (bezwijksterkte)		NEN-EN50341-2-15:2019							
Belastingsgeval	omschrijving	Temp °C	γ_G		γ_Q			γ_a A_k	
			$G_{k,mast}$	$G_{k,geleider}$	Q_{pk}	Q_{wk}	Q_{ik}		
ULS 1a	Wind	10°	1,20	1,20	0,00	1,50	0,00	0,0	
ULS 1a_0,9	Wind 0,9Gk alleen mast	10°	0,90	1,20	0,00	1,50	0,00	0,0	
ULS 1a_0,9_0,9	Wind 0,9Gk ook geleider	10°	0,90	0,90	0,00	1,50	0,00	0,0	
ULS 3	Wind+ijs	-5°	1,20	1,20	0,00	0,45	1,50	0,0	
ULS 3_0,9	Wind+ijs 0,9	-5°	0,90	1,20	0,00	0,45	1,50	0,0	
ULS 4	Koude+wind	-20°	1,20	1,20	0,00	0,30	0,00	0,0	
ULS 4_0,9	Koude+wind 0,9	-20°	0,90	1,20	0,00	0,30	0,00	0,0	
ULS 5a	Torsiebelastingen	10°	1,00	1,00	1,00	0,00	0,00	1,0	
ULS 5b	Longitudinale belastingen	10°	1,00	1,00	0,00	0,00	0,00	1,0	
ULS 6	Bouw en onderhoud	5°	1,20	1,20	1,50	0,30	0,00	0,0	
ULS 6_0,9	Bouw en onderhoud	5°	1,20	1,20	0,00	0,30	0,00	0,0	
ULS 7	Permanent	10°	1,35	1,35	0,00	0,00	0,00	0,0	
ULS 8	Special	10°	1,00	1,00	0,00	0,00	0,00	1,0	
SPLS (Bezwijksterkte, enkel voor hoekmasten: afwezigheid geleiders)			γ_G		γ_Q				
			G_k		Q_{pk}	Q_{wk}	Q_{ik}	A_k	
SPLS 1a	Wind	10°	1,20	1,20	0,0	0,78	0,00	0,0	
SPLS 1a_0,9	Wind 0,9	10°	0,90	1,20	0,0	0,78	0,00	0,0	
SPLS 1a_0,9_0,9	Wind 0,9	10°	0,90	0,90	0,0	0,78	0,00	0,0	
SPLS 3	Wind+ijs	-5°	1,20	1,20	0,0	0,36	0,34	0,0	
SPLS 3_0,9	Wind+ijs 0,9	-5°	0,90	1,20	0,0	0,36	0,34	0,0	
SPLS 4	Koude+wind	-20°	1,20	1,20	0,0	0,24	0,00	0,0	
SPLS 4_0,9	Koude+wind 0,9	-20°	0,90	1,20	0,0	0,24	0,00	0,0	
SPLS 6	Bouw en onderhoud	5°	1,20	1,20	1,2	0,24	0,0	0,0	
SPLS 6_0,9	Bouw en onderhoud	5°	1,20	1,20	0,0	0,24	0,0	0,0	
SLS (controle van de vervormingen, vermoeiing, EDS)			G_k		Q_{pk}	Q_{wk}	Q_{ik}	A_k	
SLS 1a	Wind	10°	1,00	1,00	0,0	1,00	0,0	0,0	
SLS 3	Wind+ijs	-5°	1,00	1,00	0,0	0,30	1,00	0,0	
SLS 4	Wind	-20°	1,00	1,00	0,0	0,20	0,0	0,0	
SLS 6	Bouw en onderhoud	5°	1,00	1,00	0,0	0,20	0,0	0,0	
SLS 7	PB (EDS, geen wind)	10°	1,00	1,00	0,0	0,00	0,0	0,0	

Aantal windrichtingen 4
 Aantal belastingcombinaties ULS 62
 Aantal belastingcombinaties SPLS 0
 Aantal belastingcombinaties SLS 11
 Aantal knooplasten 1022

Project: RLL-TLB380
 Masttype: S-3_c
 Mast: 1119

Samenvattingstabellen geleiderbelastingen

In de onderstaande vier tabellen is weergegeven:

- De maximale geleiderbelasting in het globale assenstelsel, gesplitst in aandeel van back en ahead span
- De gecombineerde geleiderbelasting (Ba+Ah) in het globale assenstelsel met in het lokale assenstelsel de maximaal optredende trekkracht. Componenten Fx en Fy als absolute waarde
- De alledaagse (EDS) waarden van de gecombineerde geleiderbelastingen (Ba+Ah) met bijbehorende trekkrachten
- Controle op uplift, waar een negatieve waarde duidt op uplift

Maximale waarden voor back en ahead span

Geleider	Fx_ba [kN]	Fx_ah [kN]	Fy_ba [kN]	Fy_ah [kN]	Fz_ba [kN]	Fz_ah [kN]
bl1	-65,8	65,8	5,5	5,5	10,5	10,5
380ct1f1	-256,2	256,2	22,3	22,3	36,6	36,6
380ct1f2	-260,3	260,3	25,1	25,1	36,7	36,7
380ct1f3	-264,1	264,1	27,4	27,4	36,7	36,7
380ct2f1	-256,2	256,2	22,3	22,3	36,6	36,6
380ct2f2	-260,3	260,3	25,1	25,1	36,7	36,7
380ct2f3	-264,1	264,1	27,4	27,4	36,7	36,7
150ct3f1	-128,2	128,2	11,2	11,2	18,8	18,8
150ct3f2	-130,2	130,2	12,6	12,6	18,8	18,8
150ct3f3	-132,1	132,1	13,7	13,7	18,8	18,8
150ct4f1	-128,2	128,2	11,2	11,2	18,8	18,8
150ct4f2	-130,2	130,2	12,6	12,6	18,8	18,8
150ct4f3	-132,1	132,1	13,7	13,7	18,8	18,8
bl2	-64,9	64,9	5,5	5,5	10,4	10,4

Min. Weight span (m)

Weight spar Combinatie1

Geleider	SLS 1a	SLS 4	SLS 7
bl1	454,0	464,6	454,0
380ct1f1	454,0	463,6	454,0
380ct1f2	454,0	463,8	454,0
380ct1f3	454,0	464,0	454,0
380ct2f1	454,0	463,6	454,0
380ct2f2	454,0	463,8	454,0
380ct2f3	454,0	464,0	454,0
150ct3f1	454,0	463,6	454,0
150ct3f2	454,0	463,8	454,0
150ct3f3	454,0	464,0	454,0
150ct4f1	454,0	463,6	454,0
150ct4f2	454,0	463,8	454,0
150ct4f3	454,0	464,0	454,0
bl2	454,0	464,8	454,0

Max. Weight span (m)

Weight spar Combinatie1

Geleider	ULS 1a	ULS 3
bl1	508,9	442,0
380ct1f1	473,3	451,1
380ct1f2	477,7	451,9
380ct1f3	481,2	452,7
380ct2f1	473,3	451,1
380ct2f2	477,7	451,9
380ct2f3	481,2	452,7
150ct3f1	473,5	451,1
150ct3f2	477,9	451,9
150ct3f3	481,4	452,7
150ct4f1	473,5	451,1
150ct4f2	477,9	451,9
150ct4f3	481,4	452,7
bl2	510,4	441,7

Omhullende weight span over alle combinaties (incl. 0,9 combinaties)

Voor alle geleiders

Max. weight span	510,4 m
Min. weight span	256,4 m

Wind / Weight span verhouding

	1,276 -
	0,641 -

Project: RLL-TLB380
 Masttype: S-3_c
 Mast: 1119

Maximale waarden back+ahead span Maximale waarden trekkracht geleider

Geleider	Fx	Fy	Fz	Ft_ba	Ft_ah
	[kN]	[kN]	[kN]	[kN]	[kN]
bl1	25,8	11,0	20,9	-65,8	65,8
380ct1f1	105,1	44,5	73,3	-256,2	256,2
380ct1f2	105,1	50,3	73,4	-260,3	260,3
380ct1f3	105,1	54,8	73,5	-264,1	264,1
380ct2f1	105,1	44,5	73,3	-256,2	256,2
380ct2f2	105,1	50,3	73,4	-260,3	260,3
380ct2f3	105,1	54,8	73,5	-264,1	264,1
150ct3f1	52,5	22,4	36,9	-128,2	128,2
150ct3f2	52,5	25,3	37,0	-130,2	130,2
150ct3f3	52,5	27,5	37,1	-132,1	132,1
150ct4f1	52,5	22,4	36,9	-128,2	128,2
150ct4f2	52,5	25,3	37,0	-130,2	130,2
150ct4f3	52,5	27,5	37,1	-132,1	132,1
bl2	25,1	11,0	20,7	-64,9	64,9

EDS-belastingen geleiders

Geleider	Fx	Fy	Fz	Ft_ba	Ft_ah
	[kN]	[kN]	[kN]	[kN]	[kN]
bl1	0,0	0,0	4,4	-17,2	17,2
380ct1f1	0,0	0,0	37,6	-131,3	131,3
380ct1f2	0,0	0,0	37,6	-131,3	131,3
380ct1f3	0,0	0,0	37,6	-131,3	131,3
380ct2f1	0,0	0,0	37,6	-131,3	131,3
380ct2f2	0,0	0,0	37,6	-131,3	131,3
380ct2f3	0,0	0,0	37,6	-131,3	131,3
150ct3f1	0,0	0,0	19,1	-65,7	65,7
150ct3f2	0,0	0,0	19,1	-65,7	65,7
150ct3f3	0,0	0,0	19,1	-65,7	65,7
150ct4f1	0,0	0,0	19,1	-65,7	65,7
150ct4f2	0,0	0,0	19,1	-65,7	65,7
150ct4f3	0,0	0,0	19,1	-65,7	65,7
bl2	0,0	0,0	4,3	-16,8	16,8

Controle uplift SLS-wind

Combinatie: Geleider	Fz_ba	Fz_ah
	[kN]	[kN]
SLS 4		
bl1	2,3	2,3
380ct1f1	19,2	19,2
380ct1f2	19,2	19,2
380ct1f3	19,2	19,2
380ct2f1	19,2	19,2
380ct2f2	19,2	19,2
380ct2f3	19,2	19,2
150ct3f1	9,7	9,7
150ct3f2	9,7	9,7
150ct3f3	9,7	9,7
150ct4f1	9,7	9,7
150ct4f2	9,7	9,7
150ct4f3	9,7	9,7
bl2	2,2	2,2

Project: RLL-TLB380
 Masttype: S-3_c
 Mast: 1119

ULS-fundatiebelasting combinatie 1 en 3 wind haaks op de lijn of bissectrice en EDS, vanuit geleiders

Combinatie	Combination	F_x [kN]	F_y [kN]	F_z [kN]	M_x [kNm]	M_y [kNm]	M_z [kNm]
ULS 1a_90		0	471	438	19183	0	0
ULS 1a_0,9_90		0	471	311	19183	0	0
ULS 3_90		0	261	704	10714	0	0
ULS 3_0,9_90		0	261	556	10713	0	0
SLS 7		0	0	349	2	0	0

ULS-fundatiebelasting combinatie 1 en 3 wind haaks op de lijn of bissectrice en EDS, totaal geleiders en mast

Combinatie	F_x [kN]	F_y [kN]	F_z [kN]	M_x [kNm]	M_y [kNm]	M_z [kNm]
ULS 1a_90	0	745	940	27202	0	0
ULS 3_90	0	343	1206	13120	0	0
SLS 7	0	0	767	2	0	0

Fundatiebelastingen, selectie belastingcombinaties op basis grootste waarde

Combinatie	F_x [kN]	F_y [kN]	F_z [kN]	M_x [kNm]	M_y [kNm]	M_z [kNm]
ULS 1a_90	0	745	940	27202	0	0
ULS 8 Ah	309	0	920	3	12769	10
ULS 5a Ba 11	105	0	764	-230	4140	1471
ULS 1a_90	0	745	940	27202	0	0

Noot: grootste waarden kunnen in meerdere combinaties voorkomen, een combinatie is weergegeven.

Oplegreacties op fundering per randstijl

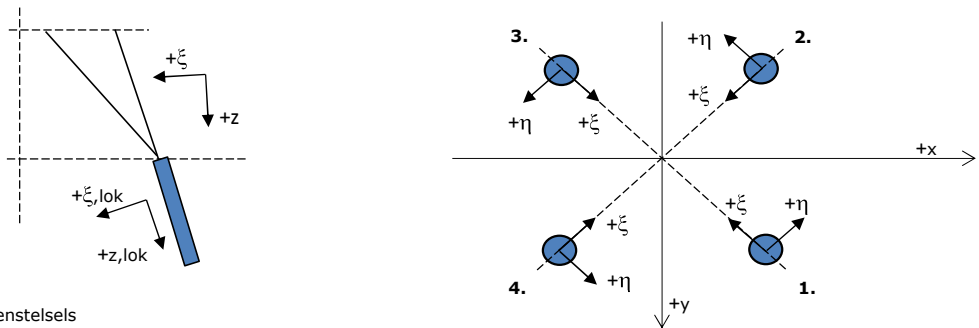

Assenstelsels

Maximale drukbelasting

Stijl	Combinatie	R_x [kN]	R_y [kN]	R_z [kN]	R_η [kN]	R_ξ [kN]	$R_{\xi,lok}$ [kN]	$R_{z,lok}$ [kN]
1	ULS 1a_90	271	225	1641	32	-351	-2	1678
2	ULS 8 Ah	115	-147	890	23	-185	3	910
3	ULS 8 Ba	-115	-147	890	-23	-185	3	910
4	ULS 1a_90	-271	225	1641	-32	-351	-2	1678

Maximale trekbelasting

Stijl	Combinatie	R_x [kN]	R_y [kN]	R_z [kN]	R_η [kN]	R_ξ [kN]	$R_{\xi,lok}$ [kN]	$R_{z,lok}$ [kN]
1	ULS 8 Ba	-40	-71	-430	22	78	-13	-440
2	ULS 1a_0,9_0,9_90	-207	162	-1257	32	261	-6	-1285
3	ULS 1a_0,9_0,9_90	207	162	-1257	-32	261	-6	-1285
4	ULS 1a_0,9_0,9_0	70	-81	-493	-8	107	2	-504

Maximale torsiebelasting (positief)

Stijl	Combinatie	R_x [kN]	R_y [kN]	R_z [kN]	R_η [kN]	R_ξ [kN]	$R_{\xi,lok}$ [kN]	$R_{z,lok}$ [kN]
1	ULS 5a Ah 21	45	-42	-11	62	-2	-5	-11
2	ULS 5a Ba 11	22	-105	417	59	-90	-1	426
3	ULS 5a Ba 11	-45	42	-11	62	-2	-5	-11
4	ULS 5a Ah 21	-22	105	417	59	-90	-1	426

Maximale torsiebelasting (negatief)

Stijl	Combinatie	R_x [kN]	R_y [kN]	R_z [kN]	R_η [kN]	R_ξ [kN]	$R_{\xi,lok}$ [kN]	$R_{z,lok}$ [kN]
1	ULS 5a Ba 21	22	105	417	-59	-90	-1	426
2	ULS 5a Ah 11	45	42	-11	-62	-2	-5	-11
3	ULS 5a Ah 11	-22	-105	417	-59	-90	-1	426
4	ULS 5a Ba 21	-45	-42	-11	-62	-2	-5	-11

Project: RLL-TLB380
 Masttype: S-3_c
 Mast: 1119

Combinatie Ftrek+Fhor

Stijl	Combinatie	R _x [kN]	R _y [kN]	R _z [kN]	R _η [kN]	R _ξ [kN]	R _{ξ,lok} [kN]	R _{z,lok} [kN]
1	ULS 8 Ba	-40	-71	-430	22	78	-13	-440
2	ULS 1a_0,9_0,9_90	-207	162	-1257	32	261	-6	-1285
3	ULS 1a_0,9_0,9_90	207	162	-1257	-32	261	-6	-1285
4	ULS 1a_0,9_0,9_0	70	-81	-493	-8	107	2	-504

Permanente belasting

Stijl	Combinatie	R _x [kN]	R _y [kN]	R _z [kN]	R _η [kN]	R _ξ [kN]	R _{ξ,lok} [kN]	R _{z,lok} [kN]
1	SLS 7	32	32	192	0	-45	-4	196
2	SLS 7	32	-32	192	0	-45	-4	196
3	SLS 7	-32	-32	192	0	-45	-4	196
4	SLS 7	-32	32	192	0	-45	-4	196

Omhullenden ongeacht stijl

Belasting	Combinatie	R _x [kN]	R _y [kN]	R _z [kN]	R _η [kN]	R _ξ [kN]	R _{ξ,lok} [kN]	R _{z,lok} [kN]
Max. druk	ULS 1a_90	271	225	1641	32	-351	-2	1678
Max. trek	ULS 1a_0,9_0,9_90	-207	162	-1257	32	261	-6	-1285
Max. pos. torsie	ULS 5a Ah 21	45	-42	-11	62	-2	-5	-11
Max. neg. torsie	ULS 5a Ba 21	-45	-42	-11	-62	-2	-5	-11
Comb. trek+torsie	ULS 1a_0,9_0,9_90	-207	162	-1257	32	261	-6	-1285

Maximale trekbelasting SLS

Stijl	Combinatie	R _x [kN]	R _y [kN]	R _z [kN]	R _η [kN]	R _ξ [kN]	R _{ξ,lok} [kN]	R _{z,lok} [kN]
1	SLS 7	32	32	192	0	-45	-4	196
2	SLS 1a_90	-123	92	-743	22	152	-6	-759
3	SLS 1a_90	123	92	-743	-22	152	-6	-759
4	SLS 1a_0	32	-40	-241	-5	51	0	-246

Maximale drukbelasting SLS

Stijl	Combinatie	R _x [kN]	R _y [kN]	R _z [kN]	R _η [kN]	R _ξ [kN]	R _{ξ,lok} [kN]	R _{z,lok} [kN]
1	SLS 1a_90	187	156	1133	22	-243	-2	1158
2	SLS 1a_0	95	-103	625	5	-140	-8	638
3	SLS 7	-32	-32	192	0	-45	-4	196
4	SLS 1a_90	-187	156	1133	-22	-243	-2	1158

Project: RLL-TLB380
Masttype: S-3_c
Mast: 1119

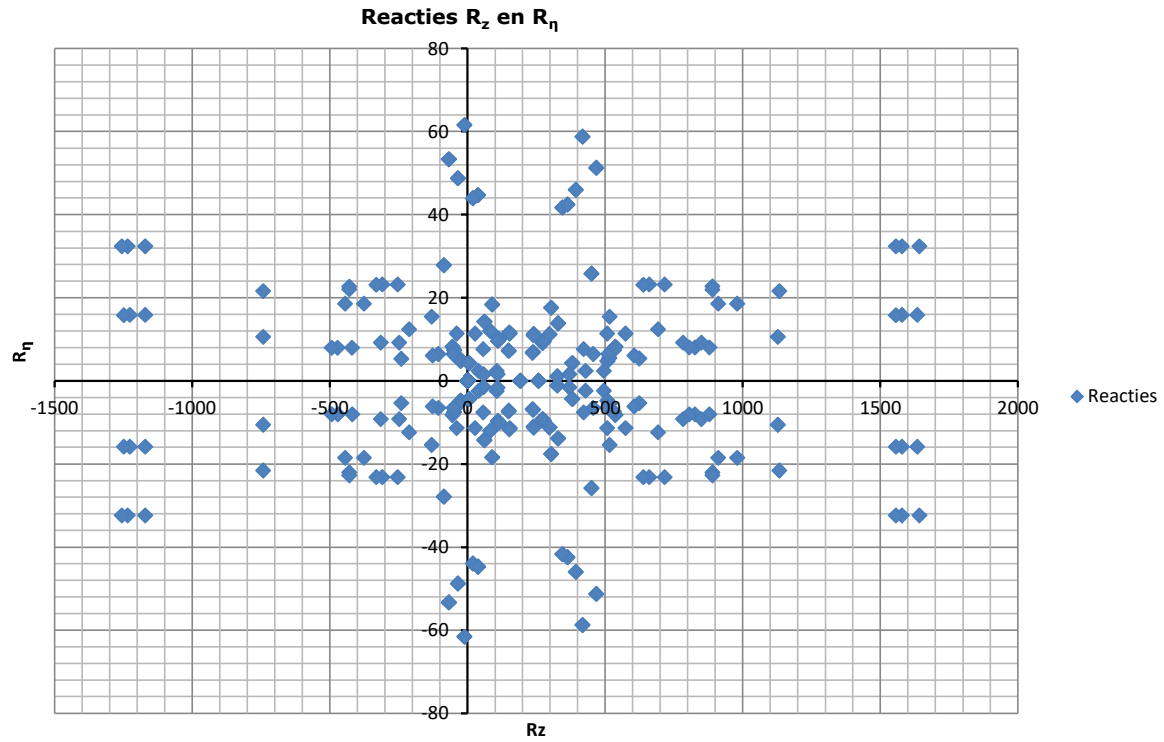

Project: RLL-TLB380
Tower: S+0_c
Number: 1111

Auteur: TBR
Versie: v11.8

Geleiderbelastingen

Algemeen

Benaming S+0_c
Masttype Steunmast
Aantal circuits 4
Configuratie 4-circuit-dubbel verticaal
Aantal bliksemgeleiders 2

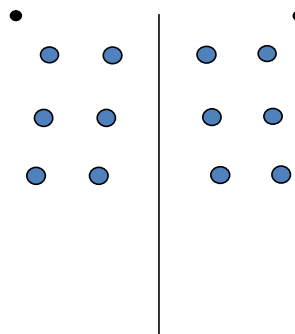

Configuratie geleiders

Uitgangspunten

Norm NEN-EN50341-2-15:2019
Gevolgklasse initieel CC2
Betrouwbaarheidsniveau initieel Nieuwbouw
Referentieperiode initieel 50 jaar
Betrouwbaarheidsniveau na aanpassing n.v.t.
50 jaar
Windgebied III
Windsnelheid (m/s) 24,5 m/s
Terreincategorie II
Reductiefactor c_{dir} 1,00
IJsgebied fasegeleider B
IJsgebied bliksemgeleider A

Geleiders Back

Omschrijving	Spanning	Geleider Back	Bundel Ba	IJsgebied	Toeslag gewicht	Toeslag diameter	Intrekwaarden P_{back}
Circuit 1	380 kV	AAAC-AL7 620	4	B	3 %	3 %	1800
Circuit 2	380 kV	AAAC-AL7 620	4	B	3 %	3 %	1800
Circuit 3	150 kV	AAAC-AL7 620	2	B	3 %	3 %	1800
Circuit 4	150 kV	AAAC-AL7 620	2	B	3 %	3 %	1800
Bliksemdraad 1		AACSR 241-AL3-39-A20SA	1	A	2 %	2 %	1800
Bliksemdraad 2		OPGW AFL-226/38	1	A	2 %	2 %	1800

Geleiders Ahead

Omschrijving	Spanning	Geleider Ahead	Bundel Ah	IJsgebied	Toeslag gewicht	Toeslag diameter	Intrekwaarden P_{ahead}
Circuit 1	380 kV	AAAC-AL7 620	4	B	3 %	3 %	1800
Circuit 2	380 kV	AAAC-AL7 620	4	B	3 %	3 %	1800
Circuit 3	150 kV	AAAC-AL7 620	2	B	3 %	3 %	1800
Circuit 4	150 kV	AAAC-AL7 620	2	B	3 %	3 %	1800
Bliksemdraad 1		AACSR 241-AL3-39-A20SA	1	A	2 %	2 %	1800
Bliksemdraad 2		OPGW AFL-226/38	1	A	2 %	2 %	1800

Isolatoren (1)

Omschrijving	Ophanging	Gewicht [kN]	Lengte [m]	Windopp. [m ²]
Circuit 1	V-ketting	4,50	4,50	2,00
Circuit 2	V-ketting	4,50	4,50	2,00
Circuit 3	V-ketting	2,50	4,00	1,40
Circuit 4	V-ketting	2,50	4,00	1,40
Bliksemdraad 1	Vast (Bliksemdraad)	0,10	0,20	0,10
Bliksemdraad 2	Vast (Bliksemdraad)	0,10	0,20	0,10

1. Eigenschappen gelden voor geheel van de isolatorset

Ophanghoogte en positie in mast

Circuits	Aanduiding	Nummer	Ophanghoogte	Aangrippunt	Positie in mast Horizontale afstand
Circuit 1	10	380ct1f1	28,4 m	32,9 m	11,0 m
Circuit 1	11	380ct1f2	37,9 m	42,4 m	14,0 m
Circuit 1	12	380ct1f3	47,9 m	52,4 m	10,6 m
Circuit 2	20	380ct2f1	28,4 m	32,9 m	-11,0 m
Circuit 2	21	380ct2f2	37,9 m	42,4 m	-14,0 m
Circuit 2	22	380ct2f3	47,9 m	52,4 m	-10,6 m
Circuit 3	30	150ct3f1	28,9 m	32,9 m	4,7 m
Circuit 3	31	150ct3f2	38,4 m	42,4 m	7,6 m
Circuit 3	32	150ct3f3	48,4 m	52,4 m	4,3 m
Circuit 4	40	150ct4f1	28,9 m	32,9 m	-4,7 m
Circuit 4	41	150ct4f2	38,4 m	42,4 m	-7,6 m
Circuit 4	42	150ct4f3	48,4 m	52,4 m	-4,3 m
Bliksemdraad 1	1	bl1	53,7 m	53,9 m	16,0 m
Bliksemdraad 2	3	bl2	53,7 m	53,9 m	-16,0 m

Project: RLL-TLB380
 Tower: S+0_c
 Number: 1111

Hoogteaanpassing naastgelegen masten (aanpassing wind- en weight span)

	Back	Ahead	
Verhoging voor windbelasting	6,0 m	6,0 m	(positief: omhoog)
Verlaging voor verticale belasting	-6,0 m	-6,0 m	(negatief: omlaag, grotere weight span)
Verlaging:	Niet in 0,9EG-combinaties		

Hoogteafwijking mastbeeld naastgelegen masten en richtingsverandering t.o.v. Lijnrichting

Circuits	Aanduiding	Nummer	Hoogteverschil		Richtingsverandering	
			Δh_{back}	Δh_{ahead}	Δy_{back}	Δy_{ahead}
Circuit 1	10	380ct1f1	0,0	0,0 m	0,0	0,0 m
Circuit 1	11	380ct1f2	0,0	0,0 m	0,0	0,0 m
Circuit 1	12	380ct1f3	0,0	0,0 m	0,0	0,0 m
Circuit 2	20	380ct2f1	0,0	0,0 m	0,0	0,0 m
Circuit 2	21	380ct2f2	0,0	0,0 m	0,0	0,0 m
Circuit 2	22	380ct2f3	0,0	0,0 m	0,0	0,0 m
Circuit 3	30	150ct3f1	0,0	0,0 m	0,0	0,0 m
Circuit 3	31	150ct3f2	0,0	0,0 m	0,0	0,0 m
Circuit 3	32	150ct3f3	0,0	0,0 m	0,0	0,0 m
Circuit 4	40	150ct4f1	0,0	0,0 m	0,0	0,0 m
Circuit 4	41	150ct4f2	0,0	0,0 m	0,0	0,0 m
Circuit 4	42	150ct4f3	0,0	0,0 m	0,0	0,0 m
Bliksemdraad 1	1	bl1	0,0	0,0 m	0,0	0,0 m
Bliksemdraad 2	3	bl2	0,0	0,0 m	0,0	0,0 m

Lijn- en mastgegevens

	Back	Ahead
Ruling span $\sqrt{(\Sigma L^3/\Sigma L)}$	400,0	400,0 m
Lijnhoek	180 °	
Rotatie mast t.o.v. bissectrice	θ	0 °
Vaklengte	800	800 m
Hoogte onderkant mast t.o.v. maaiveld	0,5 m	
Beschouwde windrichtingen	α_1	0 °
Windrichtingen volgens:	α_2	45 °
<i>Geleiderbelastingen</i>	α_3	90 °
	α_4	135 °
	α_5	- °
	α_6	- °

Windrichtingen gelden t.o.v. hoofdrichting mastconstructie, niet t.o.v. bissectrice.

Windrichtingen en positieve richtingen belastingen

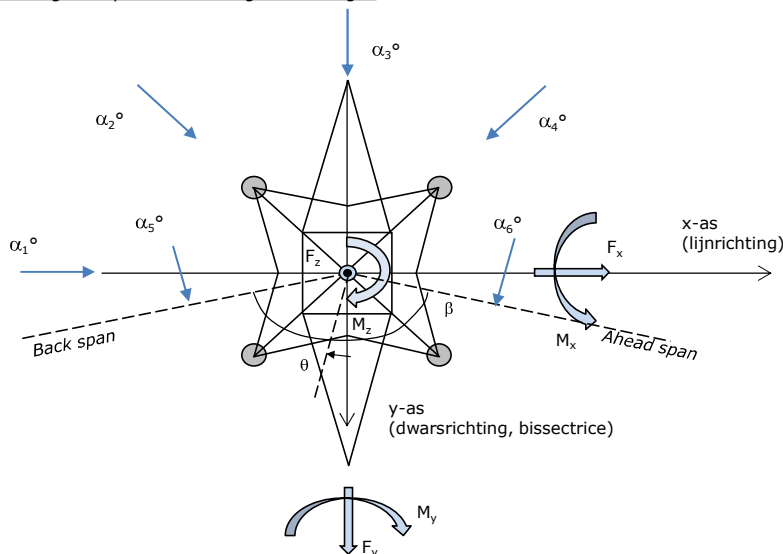

Beschouwd aantal windrichtingen	
1a	4
3	4
4	1
6	1
Overig	1

Project: RLL-TLB380
 Tower: S+0_c
 Number: 1111

Geleiderafval

		SPLS - torsie		SPLS - Enkelzijdige trek		5a - geleiderbreuk	
		Aanw.	Afw.	Aanw.	Afw.	Aanw.	Afw.
Circuit 1	380ct1f1	1	0	1	0	0,8	0
Circuit 1	380ct1f2	1	0	1	0	0,8	0
Circuit 1	380ct1f3	1	0	1	0	0,8	0
Circuit 2	380ct2f1	0	1	1	0	0,8	0
Circuit 2	380ct2f2	0	1	1	0	0,8	0
Circuit 2	380ct2f3	0	1	1	0	0,8	0
Circuit 3	150ct3f1	1	0	1	0	0,8	0
Circuit 3	150ct3f2	1	0	1	0	0,8	0
Circuit 3	150ct3f3	1	0	1	0	0,8	0
Circuit 4	150ct4f1	0	1	1	0	0,8	0
Circuit 4	150ct4f2	0	1	1	0	0,8	0
Circuit 4	150ct4f3	0	1	1	0	0,8	0
Bliksemdraad 1	b1	1	0	1	0	1	0
Bliksemdraad 2	b2	0	1	1	0	1	0

Belastingsituaties SPLS

Beschouwde situaties SPLS: SPLS voor steunmast niet van toepassing

Principe belastingssituaties:

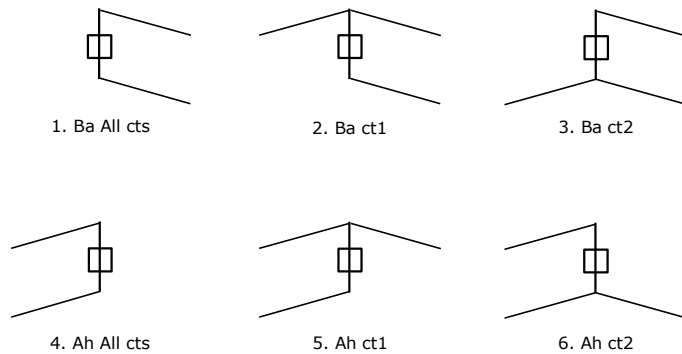

Belastingsituaties 5a. Geleiderbreuk

Beschouwde situaties geleiderbreuk 5a: 1 en 2, alle mogelijke situaties.

Principe belastingssituaties:

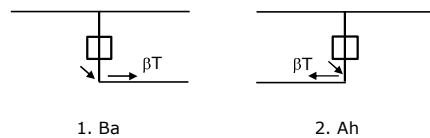

Project: RLL-TLB380
 Tower: S+0_c
 Number: 1111

Belastingsituaties 6. Bouw- en onderhoud

Onder 6a wordt de belasting door aanwezigheid lijnwagen of lijnfiets in combinatie met puntlast op traverse in rekening gebracht. Combinatie 6b bevat geen belastingen in geleider of op traverse. Deze combinatie is toegevoegd om te kunnen combineren met separate controle bordessen etc. De situaties worden in ULS en in iedere SPLS-situatie (in geval van hoekmast) toegepast.

	Fase	Bliksem
Lijnwagen	4,0 kN	2,0 kN
Puntlast op traverse	1,0 kN	1,0 kN

Beschouwde situaties bouw- en onderhoud 6a: 1 t/m 4, alle mogelijke situaties.

Aanwezigheid lijnwagen: Circuit, belasting tegelijk aanwezig in alle geleiders per circuit.

Principe belastingssituaties:

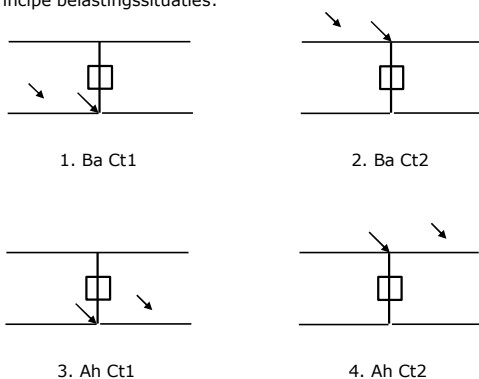

Belastingsituaties 8. Lijndansen als statische belasting

Geleider		
Steunmast fase	0,866 W	1,5 W
Steunmast bliksem	1,5 EDS	1,5 W
Hoekmast fase en bliksem	1,5 EDS	1,5 W

Considered situations galloping 8: 1 and 2, all possible situations

Belasting tegelijk aanwezig in alle geleiders van het circuit.

Principe belastingssituaties:

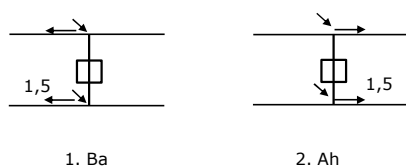

Belastingcombinatie 8. Lijndansen als dynamische belasting

Alleen van toepassing op hoek- en eindmasten

Belasting bestaat uit EDS-trekbelasting in één van de geleiders aan één zijde van de mast

Door gebruiker via het belastingsspectrum van tabel 4.11/NL.1 om te zetten naar spanningspectrum

Project: RLL-TLB380
 Tower: S+0_c
 Number: 1111

Mastconstructie

Eigenschappen

Masttype	Steunmast	
Mastbenaming	S+0_c	
Voetplaat t.o.v. maaiveld	0,5 m	
Masthoogte t.o.v. voetplaat	56,7 m	
Gewicht mast	442,0 kN	
<i>Breedte en helling mast bij fundatie</i>	x-ri.	y-ri.
Pootsprei	9,96	9,96 m
Helling van de randstijl	0,150	0,150 -
Factor spatkracht	1,1	1,1 -

Berekening windbelasting

Dynamische invloed G_T	1,00 (<i>Masthoogte < 60 m</i>)
Windbelasting overhoeks op mastlichaam evenredig met:	$(A1C1\sin^2(\phi)+A2C2\cos^2(\phi))$
Windbelasting overhoeks op traverse evenredig met:	$(A1C1\sin^2(\phi)+A2C2\cos^2(\phi))$
Vergroting wind overhoeks mastlichaam	$(1+0,2\sin^2(2\phi))$
Vergroting wind overhoeks traverse	$(1+0,2\sin^2(2\phi))$
Factor wind evenwijdig t.o.v. haaks op traverse	0,4

Eigenschappen mastsecties langsrichting (vooraanzicht, yz-vlak)

Omschrijving	h [m]	b ₁ [m]	b ₂ [m]	Δh [m]	Δ _x [m]	A ₀ [m ²]	A ₁ [m ²]	χ = A ₁ /A ₀ [-]	C _t
Broekstuk	14,60	9,96	5,58	14,60	0,150	113,44	16,37	0,14	3,19
Eerste tussenstuk	24,10	5,58	4,55	9,50	0,054	48,12	9,90	0,21	2,91
Tweede tussenstuk	32,90	4,55	3,60	8,80	0,054	35,86	9,77	0,27	2,64
Bovenstuk 1	42,40	3,60	2,92	9,50	0,036	30,97	9,60	0,31	2,50
Bovenstuk 2	55,00	2,92	2,01	12,60	0,036	31,06	9,61	0,31	2,50
Topstuk	56,70	2,01		1,70		1,71	0,32	0,18	3,00
Ondertraverse	32,90	12,70		3,00		19,05	4,75	0,25	2,72
Middentraverse	42,40	16,34		3,00		24,51	6,81	0,28	2,62
Boventraverse	52,40	13,70	1,00	2,60		24,66	6,19	0,25	2,72

Eigenschappen mastsecties dwarsrichting (zijaanzicht, xz-vlak)

Omschrijving	h [m]	b ₁ [m]	b ₂ [m]	Δh [m]	Δ _x [m]	A ₀ [m ²]	A ₁ [m ²]	χ = A ₁ /A ₀ [-]	C _t
Broekstuk	14,60	9,96	5,58	14,60	0,150	113,44	16,37	0,14	3,19
Eerste tussenstuk	24,10	5,58	4,55	9,50	0,054	48,12	9,90	0,21	2,91
Tweede tussenstuk	32,90	4,55	3,60	8,80	0,054	35,86	9,77	0,27	2,64
Bovenstuk 1	42,40	3,60	2,92	9,50	0,036	30,97	9,60	0,31	2,50
Bovenstuk 2	55,00	2,92	2,01	12,60	0,036	31,06	9,61	0,31	2,50
Topstuk	56,70	2,01		1,70		1,71	0,32	0,18	3,00
Ondertraverse	32,90	12,70		3,00		19,05	4,75	0,25	2,72
Middentraverse	42,40	16,34		3,00		24,51	6,81	0,28	2,62
Boventraverse	52,40	13,70	1,00	2,60		24,66	6,19	0,25	2,72

NB: oppervlakte traverse dwarsrichting wordt in berekening gereduceerd.

Project: RLL-TLB380
 Tower: S+0_c
 Number: 1111

Windoppervlak feeders telecominstallaties

Onderdeel	A (m ² /m)	Factor	Δh	A ₁
Broekstuk	0,14	0,71	14,6	1,4
Eerste tussenstuk	0,14	0,71	9,5	0,9
Tweede tussenstuk	0,14	0,71	8,8	0,9
Bovenstuk 1	0,14	0,71	9,5	0,9
Bovenstuk 2				

Invoer antennes

Omschrijving	A (m ²)	h (m)	C _r (m)
Antenne top			
Antenne o.t.	4,7	39,2	1,5

Belastingen mastsectie langsrichting (x-richting) per windrichting

Omschrijving	P _w [kN/m ²]	F _{x1} [kN]	F _{x2} [kN]	F _{x3} [kN]	F _{x4} [kN]	h _{ef} [m]	M _{y1} [kNm]	M _{y2} [kNm]	M _{y3} [kNm]	M _{y4} [kNm]
Broekstuk	0,70	36,6	31,0	0,0	-31,0	7,3	266,8	226,4	0,0	-226,4
Eerste tussenstuk	0,87	25,0	21,2	0,0	-21,2	19,4	483,7	410,5	0,0	-410,5
Tweede tussenstuk	0,97	25,1	21,3	0,0	-21,3	28,5	714,8	606,5	0,0	-606,5
Bovenstuk 1	1,06	25,3	21,5	0,0	-21,5	37,7	954,4	809,8	0,0	-809,8
Bovenstuk 2	1,13	27,1	23,0	0,0	-23,0	48,7	1320,5	1120,5	0,0	-1120,5
Topstuk	1,17	1,1	0,9	0,0	-0,9	55,9	61,8	52,4	0,0	-52,4
Ondertraverse	1,02	26,5	15,7	0,0	-15,7	33,9	898,0	533,4	0,0	-533,4
Middentraverse	1,09	39,0	23,1	0,0	-23,1	43,4	1691,4	1004,7	0,0	-1004,7
Boventraverse	1,15	38,8	23,1	0,0	-23,1	53,3	2069,4	1229,2	0,0	-1229,2
Totaal		244,5	180,9	0,0	-180,9		8460,8	5993,3	0,0	-5993,3

Belastingen mastsectie dwarsrichting (y-richting) per windrichting

Omschrijving	P _w [kN/m ²]	F _{y1} [kN]	F _{y2} [kN]	F _{y3} [kN]	F _{y4} [kN]	h _{ef} [m]	M _{x1} [kNm]	M _{x2} [kNm]	M _{x3} [kNm]	M _{x4} [kNm]
Broekstuk	0,70	0,0	31,0	36,6	31,0	7,3	0,0	226,4	266,8	226,4
Eerste tussenstuk	0,87	0,0	21,2	25,0	21,2	19,4	0,0	410,5	483,7	410,5
Tweede tussenstuk	0,97	0,0	21,3	25,1	21,3	28,5	0,0	606,5	714,8	606,5
Bovenstuk 1	1,06	0,0	21,5	25,3	21,5	37,7	0,0	809,8	954,4	809,8
Bovenstuk 2	1,13	0,0	23,0	27,1	23,0	48,7	0,0	1120,5	1320,5	1120,5
Topstuk	1,17	0,0	0,9	1,1	0,9	55,9	0,0	52,4	61,8	52,4
Ondertraverse	1,02	0,0	15,7	10,6	15,7	33,9	0,0	533,4	359,2	533,4
Middentraverse	1,09	0,0	23,1	15,6	23,1	43,4	0,0	1004,7	676,6	1004,7
Boventraverse	1,15	0,0	23,1	15,5	23,1	53,3	0,0	1229,2	827,8	1229,2
Totaal		0,0	180,9	181,9	180,9		0,0	5993,3	5665,6	5993,3

Resulterende belastingen vanuit mastconstructie incl. antenne zonder geleiders niveau fundatie (kar. waarde)

Belasting / windrichting	F _x [kN]	F _y [kN]	F _z [kN]	M _x [kNm]	M _y [kNm]	M _z [kNm]
Permanente belasting	0	0	442	0	0	0
Windrichting 0°	252	0	0	0	8755	0
Windrichting 45°	186	186	0	6201	6201	0
Windrichting 90°	0	189	0	5960	0	0
Windrichting 135°	-186	186	0	6201	-6201	0

Project: RLL-TLB380
 Tower: S+0_c
 Number: 1111

Tussenresultaten geleiderbelastingen

Geleiders back

Circuit	Geleider	Diameter [mm]	A [mm ²]	G [N/m]	E [N/mm ²]	αT [-]
Circuit 1	AAAC-AL7 620	32,4	621,0	17,71	56000	2,30E-05
Circuit 2	AAAC-AL7 620	32,4	621,0	17,71	56000	2,30E-05
Circuit 3	AAAC-AL7 620	32,4	621,0	17,71	56000	2,30E-05
Circuit 4	AAAC-AL7 620	32,4	621,0	17,71	56000	2,30E-05
Bliksemdraad 1	AACSR 241-AL3-39-A20SA	21,8	281,0	9,38	70165	1,97E-05
Bliksemdraad 2	OPGW AFL-226/38	21,7	264,0	9,13	72000	1,98E-05

Geleiders ahead

Circuit	Geleider	Diameter [mm]	A [mm ²]	G [N/m]	E [N/mm ²]	αT [-]
Circuit 1	AAAC-AL7 620	32,4	621,0	17,71	56000	2,30E-05
Circuit 2	AAAC-AL7 620	32,4	621,0	17,71	56000	2,30E-05
Circuit 3	AAAC-AL7 620	32,4	621,0	17,71	56000	2,30E-05
Circuit 4	AAAC-AL7 620	32,4	621,0	17,71	56000	2,30E-05
Bliksemdraad 1	AACSR 241-AL3-39-A20SA	21,8	281,0	9,38	70165	1,97E-05
Bliksemdraad 2	OPGW AFL-226/38	21,7	264,0	9,13	72000	1,98E-05

Verticale belasting back

Circuit	Bundel [-]	Toeslag [%]	$w_{z,G}$ [N/m]	IJsg gebied	Formule	$w_{z,ijs}$ [N/m]	$w_{z,ijs,bundel}$ [N/m]
Circuit 1	4	3	73,0	B	4+0,2d	10,5	41,9
Circuit 2	4	3	73,0	B	4+0,2d	10,5	41,9
Circuit 3	2	3	36,5	B	4+0,2d	10,5	21,0
Circuit 4	2	3	36,5	B	4+0,2d	10,5	21,0
Bliksemdraad 1	1	2	9,6	A	15+0,4d	23,7	23,7
Bliksemdraad 2	1	2	9,3	A	15+0,4d	23,7	23,7

Verticale belasting ahead

Circuit	Bundel [-]	Toeslag [%]	$w_{z,G}$ [N/m]	IJsg gebied	Formule	$w_{z,ijs}$ [N/m]	$w_{z,ijs,bundel}$ [N/m]
Circuit 1	4	3	73,0	B	4+0,2d	10,5	41,9
Circuit 2	4	3	73,0	B	4+0,2d	10,5	41,9
Circuit 3	2	3	36,5	B	4+0,2d	10,5	21,0
Circuit 4	2	3	36,5	B	4+0,2d	10,5	21,0
Bliksemdraad 1	1	2	9,6	A	15+0,4d	23,7	23,7
Bliksemdraad 2	1	2	9,3	A	15+0,4d	23,7	23,7

Isolatoren

Geleider	$G_{isolator}$ [kN]	Aantal	$F_{V,iso}$ [kN]	Lengte [m]	Windopp. [m ²]	Windhoogte [m]	Stuwdruk [kN/m ²]	Vormfactor	$F_{th,iso}$ [kN]
380ct1f1	4,50	1	4,5	4,5	2,0	31,15	1,00	1,2	2,40
380ct1f2	4,50	1	4,5	4,5	2,0	40,65	1,07	1,2	2,58
380ct1f3	4,50	1	4,5	4,5	2,0	50,65	1,14	1,2	2,73
380ct2f1	4,50	1	4,5	4,5	2,0	31,15	1,00	1,2	2,40
380ct2f2	4,50	1	4,5	4,5	2,0	40,65	1,07	1,2	2,58
380ct2f3	4,50	1	4,5	4,5	2,0	50,65	1,14	1,2	2,73
150ct3f1	2,50	1	2,5	4,0	1,4	31,40	1,00	1,2	1,68
150ct3f2	2,50	1	2,5	4,0	1,4	40,90	1,08	1,2	1,81
150ct3f3	2,50	1	2,5	4,0	1,4	50,90	1,14	1,2	1,92
150ct4f1	2,50	1	2,5	4,0	1,4	31,40	1,00	1,2	1,68
150ct4f2	2,50	1	2,5	4,0	1,4	40,90	1,08	1,2	1,81
150ct4f3	2,50	1	2,5	4,0	1,4	50,90	1,14	1,2	1,92
bl1	0,10	1	0,1	0,2	0,1	54,30	1,16	1,2	0,14
bl2	0,10	1	0,1	0,2	0,1	54,30	1,16	1,2	0,14

Project: RLL-TLB380
 Tower: S+0_c
 Number: 1111

Windbelasting back

Geleider	hoogte		Stuwdruk [kN/m ²]	G _{c,dwars} [-]	G _{c,trek} [-]	C _c [-]	d _{toeslag} [mm]	W _y [N/m]	W _{y,vak} [N/m]	D _{ijs,toeslag} [mm]	W _{y,ijs} [N/m]	W _{y,ijs,vak} [N/m]
	wind [m]	hoogte										
380ct1f1	24,5	0,93	0,56	0,56	1,02	33,37	71,6	71,6	51,8	130,2	130,2	
380ct1f2	34,0	1,02	0,59	0,59	0,99	33,37	79,8	79,8	51,8	149,5	149,5	
380ct1f3	44,0	1,10	0,61	0,61	0,97	33,37	86,4	86,4	51,8	165,9	165,9	
380ct2f1	24,5	0,93	0,56	0,56	1,02	33,37	71,6	71,6	51,8	130,2	130,2	
380ct2f2	34,0	1,02	0,59	0,59	0,99	33,37	79,8	79,8	51,8	149,5	149,5	
380ct2f3	44,0	1,10	0,61	0,61	0,97	33,37	86,4	86,4	51,8	165,9	165,9	
150ct3f1	25,0	0,94	0,56	0,56	1,02	33,37	36,0	36,0	51,8	65,7	65,7	
150ct3f2	34,5	1,03	0,59	0,59	0,99	33,37	40,1	40,1	51,8	75,2	75,2	
150ct3f3	44,5	1,10	0,61	0,61	0,97	33,37	43,4	43,4	51,8	83,3	83,3	
150ct4f1	25,0	0,94	0,56	0,56	1,02	33,37	36,0	36,0	51,8	65,7	65,7	
150ct4f2	34,5	1,03	0,59	0,59	0,99	33,37	40,1	40,1	51,8	75,2	75,2	
150ct4f3	44,5	1,10	0,61	0,61	0,97	33,37	43,4	43,4	51,8	83,3	83,3	
bl1	49,8	1,13	0,62	0,62	1,19	22,24	18,4	18,4	63,1	53,0	53,0	
bl2	49,8	1,13	0,62	0,62	1,19	22,13	18,4	18,4	63,0	52,9	52,9	

Windbelasting ahead

Geleider	hoogte		Stuwdruk [kN/m ²]	G _{c,dwars} [-]	G _{c,trek} [-]	C _c [-]	d _{toeslag} [mm]	W _y [N/m]	W _{y,vak} [N/m]	D _{ijs,toeslag} [mm]	W _{y,ijs} [N/m]	W _{y,ijs,vak} [N/m]
	wind [m]	hoogte										
380ct1f1	24,5	0,93	0,56	0,56	1,02	33,37	71,6	71,6	51,8	130,2	130,2	
380ct1f2	34,0	1,02	0,59	0,59	0,99	33,37	79,8	79,8	51,8	149,5	149,5	
380ct1f3	44,0	1,10	0,61	0,61	0,97	33,37	86,4	86,4	51,8	165,9	165,9	
380ct2f1	24,5	0,93	0,56	0,56	1,02	33,37	71,6	71,6	51,8	130,2	130,2	
380ct2f2	34,0	1,02	0,59	0,59	0,99	33,37	79,8	79,8	51,8	149,5	149,5	
380ct2f3	44,0	1,10	0,61	0,61	0,97	33,37	86,4	86,4	51,8	165,9	165,9	
150ct3f1	25,0	0,94	0,56	0,56	1,02	33,37	36,0	36,0	51,8	65,7	65,7	
150ct3f2	34,5	1,03	0,59	0,59	0,99	33,37	40,1	40,1	51,8	75,2	75,2	
150ct3f3	44,5	1,10	0,61	0,61	0,97	33,37	43,4	43,4	51,8	83,3	83,3	
150ct4f1	25,0	0,94	0,56	0,56	1,02	33,37	36,0	36,0	51,8	65,7	65,7	
150ct4f2	34,5	1,03	0,59	0,59	0,99	33,37	40,1	40,1	51,8	75,2	75,2	
150ct4f3	44,5	1,10	0,61	0,61	0,97	33,37	43,4	43,4	51,8	83,3	83,3	
bl1	49,8	1,13	0,62	0,62	1,19	22,24	18,4	18,4	63,1	53,0	53,0	
bl2	49,8	1,13	0,62	0,62	1,19	22,13	18,4	18,4	63,0	52,9	52,9	

Project: RLL-TLB380
 Masttype: S+0_c
 Mast: 1111

Auteur: TBR
 Versie: v11.8

Geleiderbelastingen

Uitgangspunten

Betrouwbaarheidsniveau Nieuwbouw CC2
 Referentieperiode 50 jaar

ULS (bezwijksterkte)		NEN-EN50341-2-15:2019							
Belastingsgeval	omschrijving	Temp °C	γ_G		γ_Q			γ_a A_k	
			$G_{k,mast}$	$G_{k,geleider}$	Q_{pk}	Q_{wk}	Q_{ik}		
ULS 1a	Wind	10°	1,20	1,20	0,00	1,50	0,00	0,0	
ULS 1a_0,9	Wind 0,9Gk alleen mast	10°	0,90	1,20	0,00	1,50	0,00	0,0	
ULS 1a_0,9_0,9	Wind 0,9Gk ook geleider	10°	0,90	0,90	0,00	1,50	0,00	0,0	
ULS 3	Wind+ijs	-5°	1,20	1,20	0,00	0,45	1,50	0,0	
ULS 3_0,9	Wind+ijs 0,9	-5°	0,90	1,20	0,00	0,45	1,50	0,0	
ULS 4	Koude+wind	-20°	1,20	1,20	0,00	0,30	0,00	0,0	
ULS 4_0,9	Koude+wind 0,9	-20°	0,90	1,20	0,00	0,30	0,00	0,0	
ULS 5a	Torsiebelastingen	10°	1,00	1,00	1,00	0,00	0,00	1,0	
ULS 5b	Longitudinale belastingen	10°	1,00	1,00	0,00	0,00	0,00	1,0	
ULS 6	Bouw en onderhoud	5°	1,20	1,20	1,50	0,30	0,00	0,0	
ULS 6_0,9	Bouw en onderhoud	5°	1,20	1,20	0,00	0,30	0,00	0,0	
ULS 7	Permanent	10°	1,35	1,35	0,00	0,00	0,00	0,0	
ULS 8	Special	10°	1,00	1,00	0,00	0,00	0,00	1,0	
SPLS (Bezwijksterkte, enkel voor hoekmasten: afwezigheid geleiders)			γ_G		γ_Q				
			G_k		Q_{pk}	Q_{wk}	Q_{ik}	A_k	
SPLS 1a	Wind	10°	1,20	1,20	0,0	0,78	0,00	0,0	
SPLS 1a_0,9	Wind 0,9	10°	0,90	1,20	0,0	0,78	0,00	0,0	
SPLS 1a_0,9_0,9	Wind 0,9	10°	0,90	0,90	0,0	0,78	0,00	0,0	
SPLS 3	Wind+ijs	-5°	1,20	1,20	0,0	0,36	0,34	0,0	
SPLS 3_0,9	Wind+ijs 0,9	-5°	0,90	1,20	0,0	0,36	0,34	0,0	
SPLS 4	Koude+wind	-20°	1,20	1,20	0,0	0,24	0,00	0,0	
SPLS 4_0,9	Koude+wind 0,9	-20°	0,90	1,20	0,0	0,24	0,00	0,0	
SPLS 6	Bouw en onderhoud	5°	1,20	1,20	1,2	0,24	0,0	0,0	
SPLS 6_0,9	Bouw en onderhoud	5°	1,20	1,20	0,0	0,24	0,0	0,0	
SLS (controle van de vervormingen, vermoeiing, EDS)			G_k		Q_{pk}	Q_{wk}	Q_{ik}	A_k	
SLS 1a	Wind	10°	1,00	1,00	0,0	1,00	0,0	0,0	
SLS 3	Wind+ijs	-5°	1,00	1,00	0,0	0,30	1,00	0,0	
SLS 4	Wind	-20°	1,00	1,00	0,0	0,20	0,0	0,0	
SLS 6	Bouw en onderhoud	5°	1,00	1,00	0,0	0,20	0,0	0,0	
SLS 7	PB (EDS, geen wind)	10°	1,00	1,00	0,0	0,00	0,0	0,0	

Aantal windrichtingen 4
 Aantal belastingcombinaties ULS 62
 Aantal belastingcombinaties SPLS 0
 Aantal belastingcombinaties SLS 11
 Aantal knooplasten 1022

Project: RLL-TLB380
 Masttype: S+0_c
 Mast: 1111

Samenvattingstabellen geleiderbelastingen

In de onderstaande vier tabellen is weergegeven:

- De maximale geleiderbelasting in het globale assenstelsel, gesplitst in aandeel van back en ahead span
- De gecombineerde geleiderbelasting (Ba+Ah) in het globale assenstelsel met in het lokale assenstelsel de maximaal optredende trekkracht. Componenten Fx en Fy als absolute waarde
- De alledaagse (EDS) waarden van de gecombineerde geleiderbelastingen (Ba+Ah) met bijbehorende trekkrachten
- Controle op uplift, waar een negatieve waarde duidt op uplift

Maximale waarden voor back en ahead span

Geleider	Fx_ba [kN]	Fx_ah [kN]	Fy_ba [kN]	Fy_ah [kN]	Fz_ba [kN]	Fz_ah [kN]
bl1	-66,1	66,1	5,6	5,6	10,5	10,5
380ct1f1	-257,5	257,5	23,3	23,3	36,7	36,7
380ct1f2	-261,5	261,5	25,9	25,9	36,7	36,7
380ct1f3	-265,1	265,1	28,0	28,0	36,8	36,8
380ct2f1	-257,5	257,5	23,3	23,3	36,7	36,7
380ct2f2	-261,5	261,5	25,9	25,9	36,7	36,7
380ct2f3	-265,1	265,1	28,0	28,0	36,8	36,8
150ct3f1	-128,9	128,9	12,1	12,1	18,8	18,8
150ct3f2	-130,8	130,8	13,4	13,4	18,8	18,8
150ct3f3	-132,7	132,7	14,4	14,4	18,8	18,8
150ct4f1	-128,9	128,9	12,1	12,1	18,8	18,8
150ct4f2	-130,8	130,8	13,4	13,4	18,8	18,8
150ct4f3	-132,7	132,7	14,4	14,4	18,8	18,8
bl2	-65,2	65,2	5,6	5,6	10,4	10,4

Min. Weight span (m)

Weight spar Combinatie1

Geleider	SLS 1a	SLS 4	SLS 7
bl1	454,0	464,8	454,0
380ct1f1	454,0	463,7	454,0
380ct1f2	454,0	463,9	454,0
380ct1f3	454,0	464,1	454,0
380ct2f1	454,0	463,7	454,0
380ct2f2	454,0	463,9	454,0
380ct2f3	454,0	464,1	454,0
150ct3f1	454,0	463,7	454,0
150ct3f2	454,0	463,9	454,0
150ct3f3	454,0	464,1	454,0
150ct4f1	454,0	463,7	454,0
150ct4f2	454,0	463,9	454,0
150ct4f3	454,0	464,1	454,0
bl2	454,0	465,0	454,0

Max. Weight span (m)

Weight spar Combinatie1

Geleider	ULS 1a	ULS 3
bl1	510,8	442,2
380ct1f1	474,8	451,4
380ct1f2	478,9	452,1
380ct1f3	482,2	452,9
380ct2f1	474,8	451,4
380ct2f2	478,9	452,1
380ct2f3	482,2	452,9
150ct3f1	475,1	451,4
150ct3f2	479,0	452,2
150ct3f3	482,3	452,9
150ct4f1	475,1	451,4
150ct4f2	479,0	452,2
150ct4f3	482,3	452,9
bl2	512,3	441,9

Omhullende weight span over alle combinaties (incl. 0,9 combinaties)

Voor alle geleiders

Max. weight span	512,3 m
Min. weight span	253,8 m

Wind / Weight span verhouding

	1,281 -
	0,634 -

Project: RLL-TLB380
 Masttype: S+0_c
 Mast: 1111

Maximale waarden back+ahead span Maximale waarden trekkracht geleider

Geleider	Maximale waarden back+ahead span			Maximale waarden trekkracht geleider	
	Fx [kN]	Fy [kN]	Fz [kN]	Ft_ba [kN]	Ft_ah [kN]
bl1	25,8	11,3	20,9	-66,1	66,1
380ct1f1	105,1	46,5	73,3	-257,5	257,5
380ct1f2	105,1	51,7	73,4	-261,5	261,5
380ct1f3	105,1	56,0	73,5	-265,1	265,1
380ct2f1	105,1	46,5	73,3	-257,5	257,5
380ct2f2	105,1	51,7	73,4	-261,5	261,5
380ct2f3	105,1	56,0	73,5	-265,1	265,1
150ct3f1	52,5	24,1	37,0	-128,9	128,9
150ct3f2	52,5	26,8	37,0	-130,8	130,8
150ct3f3	52,5	28,9	37,1	-132,7	132,7
150ct4f1	52,5	24,1	37,0	-128,9	128,9
150ct4f2	52,5	26,8	37,0	-130,8	130,8
150ct4f3	52,5	28,9	37,1	-132,7	132,7
bl2	25,1	11,2	20,8	-65,2	65,2

EDS-belastingen geleiders

Geleider	EDS-belastingen geleiders				
	Fx [kN]	Fy [kN]	Fz [kN]	Ft_ba [kN]	Ft_ah [kN]
bl1	0,0	0,0	4,4	-17,2	17,2
380ct1f1	0,0	0,0	37,6	-131,3	131,3
380ct1f2	0,0	0,0	37,6	-131,3	131,3
380ct1f3	0,0	0,0	37,6	-131,3	131,3
380ct2f1	0,0	0,0	37,6	-131,3	131,3
380ct2f2	0,0	0,0	37,6	-131,3	131,3
380ct2f3	0,0	0,0	37,6	-131,3	131,3
150ct3f1	0,0	0,0	19,1	-65,7	65,7
150ct3f2	0,0	0,0	19,1	-65,7	65,7
150ct3f3	0,0	0,0	19,1	-65,7	65,7
150ct4f1	0,0	0,0	19,1	-65,7	65,7
150ct4f2	0,0	0,0	19,1	-65,7	65,7
150ct4f3	0,0	0,0	19,1	-65,7	65,7
bl2	0,0	0,0	4,3	-16,8	16,8

Controle uplift SLS-wind

Combinatie: Geleider	Controle uplift SLS-wind	
	Fz_ba [kN]	Fz_ah [kN]
SLS 4		
bl1	2,3	2,3
380ct1f1	19,2	19,2
380ct1f2	19,2	19,2
380ct1f3	19,2	19,2
380ct2f1	19,2	19,2
380ct2f2	19,2	19,2
380ct2f3	19,2	19,2
150ct3f1	9,7	9,7
150ct3f2	9,7	9,7
150ct3f3	9,7	9,7
150ct4f1	9,7	9,7
150ct4f2	9,7	9,7
150ct4f3	9,7	9,7
bl2	2,2	2,2

Project: RLL-TLB380
 Masttype: S+0_c
 Mast: 1111

ULS-fundatiebelasting combinatie 1 en 3 wind haaks op de lijn of bissectrice en EDS, vanuit geleiders

Combinatie	Combination	F_x [kN]	F_y [kN]	F_z [kN]	M_x [kNm]	M_y [kNm]	M_z [kNm]
ULS 1a_90		0	491	439	21415	0	0
ULS 1a_0,9_90		0	491	310	21415	0	0
ULS 3_90		0	272	704	11997	0	0
ULS 3_0,9_90		0	272	555	11996	0	0
SLS 7		0	0	349	2	0	0

ULS-fundatiebelasting combinatie 1 en 3 wind haaks op de lijn of bissectrice en EDS, totaal geleiders en mast

Combinatie	F_x [kN]	F_y [kN]	F_z [kN]	M_x [kNm]	M_y [kNm]	M_z [kNm]
ULS 1a_90	0	775	970	30355	0	0
ULS 3_90	0	357	1235	14679	0	0
SLS 7	0	0	791	2	0	0

Fundatiebelastingen, selectie belastingcombinaties op basis grootste waarde

Combinatie	F_x [kN]	F_y [kN]	F_z [kN]	M_x [kNm]	M_y [kNm]	M_z [kNm]
ULS 1a_90	0	775	970	30355	0	0
ULS 1a_0	398	0	948	2	14001	0
ULS 5a Ba 11	105	0	788	-230	4455	1471
ULS 1a_90	0	775	970	30355	0	0

Noot: grootste waarden kunnen in meerdere combinaties voorkomen, een combinatie is weergegeven.

Oplegreacties op fundering per randstijl

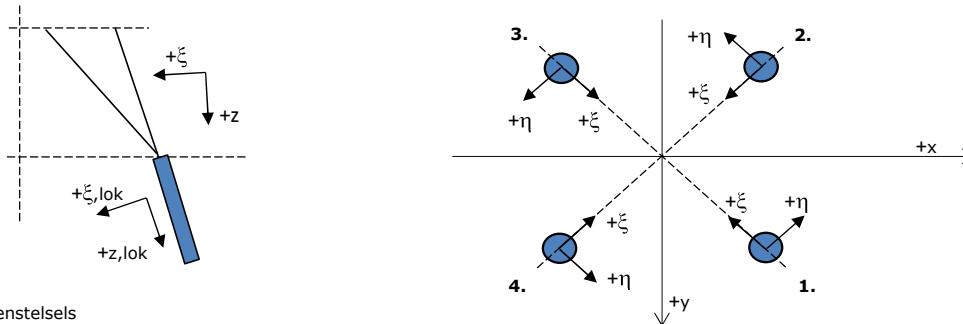

Assenstelsels

Maximale drukbelasting

Stijl	Combinatie	R_x [kN]	R_y [kN]	R_z [kN]	R_η [kN]	R_ξ [kN]	$R_{\xi,lok}$ [kN]	$R_{z,lok}$ [kN]
1	ULS 1a_90	291	234	1766	41	-371	3	1806
2	ULS 1a_0	139	-155	940	12	-208	-8	961
3	ULS 8 Ba	-116	-153	926	-26	-190	6	946
4	ULS 1a_90	-291	234	1766	-41	-371	3	1806

Maximale trekbelasting

Stijl	Combinatie	R_x [kN]	R_y [kN]	R_z [kN]	R_η [kN]	R_ξ [kN]	$R_{\xi,lok}$ [kN]	$R_{z,lok}$ [kN]
1	ULS 8 Ba	-39	-75	-453	25	80	-16	-463
2	ULS 1a_0,9_0,9_90	-226	168	-1369	41	279	-12	-1400
3	ULS 1a_0,9_0,9_90	226	168	-1369	-41	279	-12	-1400
4	ULS 1a_0,9_0,9_0	73	-89	-541	-12	115	0	-553

Maximale torsiebelasting (positief)

Stijl	Combinatie	R_x [kN]	R_y [kN]	R_z [kN]	R_η [kN]	R_ξ [kN]	$R_{\xi,lok}$ [kN]	$R_{z,lok}$ [kN]
1	ULS 5a Ah 21	45	-41	-15	61	-3	-6	-15
2	ULS 5a Ba 11	24	-106	432	58	-92	0	442
3	ULS 5a Ba 11	-45	41	-15	61	-3	-6	-15
4	ULS 5a Ah 21	-24	106	432	58	-92	0	442

Maximale torsiebelasting (negatief)

Stijl	Combinatie	R_x [kN]	R_y [kN]	R_z [kN]	R_η [kN]	R_ξ [kN]	$R_{\xi,lok}$ [kN]	$R_{z,lok}$ [kN]
1	ULS 5a Ba 21	24	106	432	-58	-92	0	442
2	ULS 5a Ah 11	45	41	-15	-61	-3	-6	-15
3	ULS 5a Ah 11	-24	-106	432	-58	-92	0	442
4	ULS 5a Ba 21	-45	-41	-15	-61	-3	-6	-15

Project: RLL-TLB380
 Masttype: S+0_c
 Mast: 1111

Combinatie Ftrek+Fhor

Stijl	Combinatie	R _x [kN]	R _y [kN]	R _z [kN]	R _η [kN]	R _ξ [kN]	R _{ξ,lok} [kN]	R _{z,lok} [kN]
1	ULS 8 Ba	-39	-75	-453	25	80	-16	-463
2	ULS 1a_0,9_0,9_90	-226	168	-1369	41	279	-12	-1400
3	ULS 1a_0,9_0,9_90	226	168	-1369	-41	279	-12	-1400
4	ULS 1a_0,9_0,9_0	73	-89	-541	-12	115	0	-553

Permanente belasting

Stijl	Combinatie	R _x [kN]	R _y [kN]	R _z [kN]	R _η [kN]	R _ξ [kN]	R _{ξ,lok} [kN]	R _{z,lok} [kN]
1	SLS 7	33	33	198	0	-46	-4	202
2	SLS 7	33	-33	198	0	-46	-4	202
3	SLS 7	-33	-33	198	0	-46	-4	202
4	SLS 7	-33	33	198	0	-46	-4	202

Omhullenden ongeacht stijl

Belasting	Combinatie	R _x [kN]	R _y [kN]	R _z [kN]	R _η [kN]	R _ξ [kN]	R _{ξ,lok} [kN]	R _{z,lok} [kN]
Max. druk	ULS 1a_90	291	234	1766	41	-371	3	1806
Max. trek	ULS 1a_0,9_0,9_90	-226	168	-1369	41	279	-12	-1400
Max. pos. torsie	ULS 5a Ah 21	45	-41	-15	61	-3	-6	-15
Max. neg. torsie	ULS 5a Ba 21	-45	-41	-15	-61	-3	-6	-15
Comb. trek+torsie	ULS 1a_0,9_0,9_90	-226	168	-1369	41	279	-12	-1400

Maximale trekbelasting SLS

Stijl	Combinatie	R _x [kN]	R _y [kN]	R _z [kN]	R _η [kN]	R _ξ [kN]	R _{ξ,lok} [kN]	R _{z,lok} [kN]
1	SLS 7	33	33	198	0	-46	-4	202
2	SLS 1a_90	-134	96	-815	27	163	-10	-833
3	SLS 1a_90	134	96	-815	-27	163	-10	-833
4	SLS 1a_0	34	-45	-271	-8	55	-2	-277

Maximale drukbelasting SLS

Stijl	Combinatie	R _x [kN]	R _y [kN]	R _z [kN]	R _η [kN]	R _ξ [kN]	R _{ξ,lok} [kN]	R _{z,lok} [kN]
1	SLS 1a_90	201	162	1217	27	-257	1	1244
2	SLS 1a_0	99	-110	666	8	-148	-6	681
3	SLS 7	-33	-33	198	0	-46	-4	202
4	SLS 1a_90	-201	162	1217	-27	-257	1	1244

Project: RLL-TLB380
Masttype: S+0_c
Mast: 1111

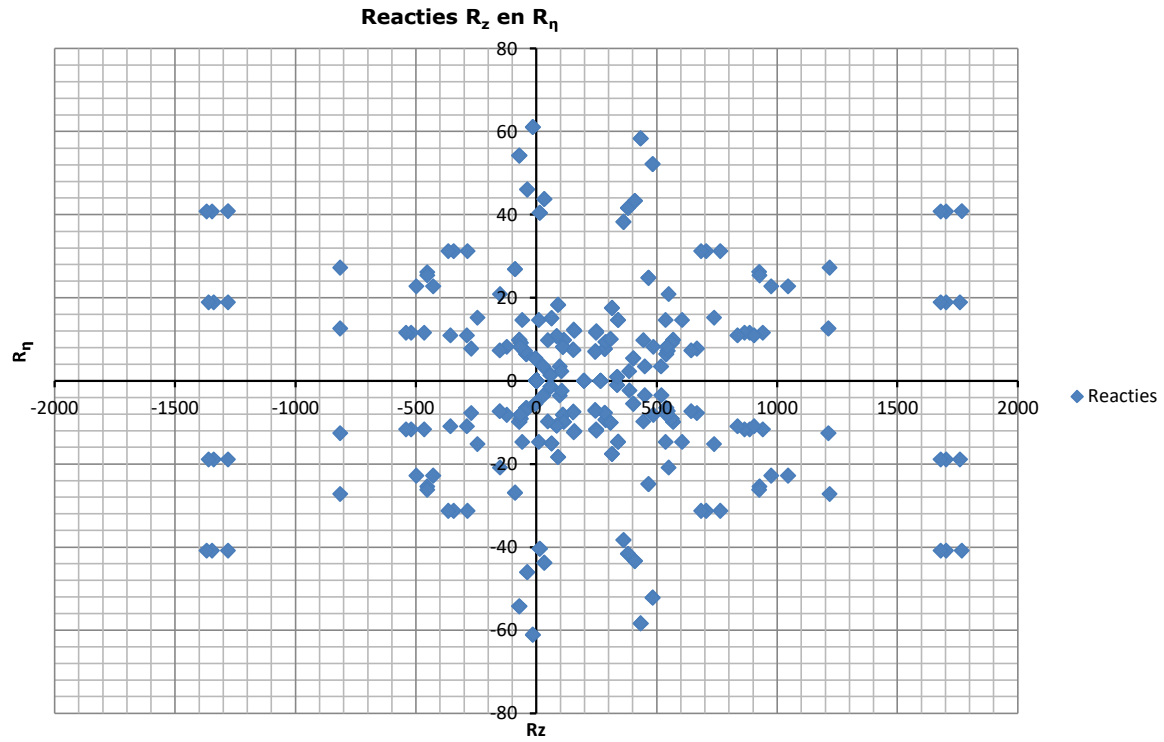

Project: RLL-TLB380
 Tower: S+3_c
 Number: 1104

Auteur: TBR
 Versie: v11.8

Geleiderbelastingen

Algemeen

Benaming S+3_c
 Masttype Steunmast
 Aantal circuits 4
 Configuratie 4-circuit-dubbel verticaal
 Aantal bliksemgeleiders 2

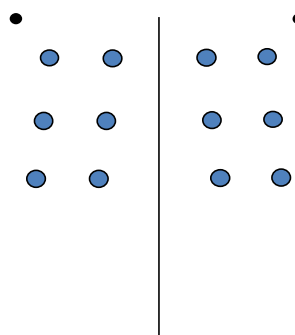

Configuratie geleiders

Uitgangspunten

Norm NEN-EN50341-2-15:2019
 Gevolgklasse initieel CC2
 Betrouwbaarheidsniveau initieel Nieuwbouw
 Referentieperiode initieel 50 jaar
 Referentieperiode na aanpassing CC2
 Betrouwbaarheidsniveau na aanpassing n.v.t.
 Referentieperiode na aanpassing 50 jaar
 Windgebied III
 Windsnelheid (m/s) 24,5 m/s
 Terreincategorie II
 Reductiefactor c_{dir} 1,00
 IJsg gebied fasegeleider B
 IJsg gebied bliksemgeleider A

Geleiders Back

Omschrijving	Spanning	Geleider Back	Bundel Ba	IJsg gebied	Toeslag gewicht	Toeslag diameter	Intrekwaarden P_{back}
Circuit 1	380 kV	AAAC-AL7 620	4	B	3 %	3 %	1800
Circuit 2	380 kV	AAAC-AL7 620	4	B	3 %	3 %	1800
Circuit 3	150 kV	AAAC-AL7 620	2	B	3 %	3 %	1800
Circuit 4	150 kV	AAAC-AL7 620	2	B	3 %	3 %	1800
Bliksemdraad 1		AACSR 241-AL3-39-A20SA	1	A	2 %	2 %	1800
Bliksemdraad 2		OPGW AFL-226/38	1	A	2 %	2 %	1800

Geleiders Ahead

Omschrijving	Spanning	Geleider Ahead	Bundel Ah	IJsg gebied	Toeslag gewicht	Toeslag diameter	Intrekwaarden P_{ahead}
Circuit 1	380 kV	AAAC-AL7 620	4	B	3 %	3 %	1800
Circuit 2	380 kV	AAAC-AL7 620	4	B	3 %	3 %	1800
Circuit 3	150 kV	AAAC-AL7 620	2	B	3 %	3 %	1800
Circuit 4	150 kV	AAAC-AL7 620	2	B	3 %	3 %	1800
Bliksemdraad 1		AACSR 241-AL3-39-A20SA	1	A	2 %	2 %	1800
Bliksemdraad 2		OPGW AFL-226/38	1	A	2 %	2 %	1800

Isolatoren (1)

Omschrijving	Ophanging	Gewicht [kN]	Lengte [m]	Windopp. [m ²]
Circuit 1	V-ketting	4,50	4,50	2,00
Circuit 2	V-ketting	4,50	4,50	2,00
Circuit 3	V-ketting	2,50	4,00	1,00
Circuit 4	V-ketting	2,50	4,00	1,00
Bliksemdraad 1	Vast (Bliksemdraad)	0,10	0,20	0,10
Bliksemdraad 2	Vast (Bliksemdraad)	0,10	0,20	0,10

1. Eigenschappen gelden voor geheel van de isolatorset

Ophanghoogte en positie in mast

Circuits	Aanduiding	Nummer	Ophanghoogte	Aangrippunt	Positie in mast Horizontale afstand
Circuit 1	10	380ct1f1	31,4 m	35,9 m	11,3 m
Circuit 1	11	380ct1f2	40,9 m	45,4 m	14,0 m
Circuit 1	12	380ct1f3	50,9 m	55,4 m	10,3 m
Circuit 2	20	380ct2f1	31,4 m	35,9 m	-11,3 m
Circuit 2	21	380ct2f2	40,9 m	45,4 m	-14,0 m
Circuit 2	22	380ct2f3	50,9 m	55,4 m	-10,3 m
Circuit 3	30	150ct3f1	31,9 m	35,9 m	5,0 m
Circuit 3	31	150ct3f2	41,4 m	45,4 m	7,7 m
Circuit 3	32	150ct3f3	51,4 m	55,4 m	4,0 m
Circuit 4	40	150ct4f1	31,9 m	35,9 m	-5,0 m
Circuit 4	41	150ct4f2	41,4 m	45,4 m	-7,7 m
Circuit 4	42	150ct4f3	51,4 m	55,4 m	-4,0 m
Bliksemdraad 1	1	bl1	56,7 m	56,9 m	16,0 m
Bliksemdraad 2	3	bl2	56,7 m	56,9 m	-16,0 m

Project: RLL-TLB380
 Tower: S+3_c
 Number: 1104

Hoogteaanpassing naastgelegen masten (aanpassing wind- en weight span)

	Back	Ahead	
Verhoging voor windbelasting	6,0 m	6,0 m	(positief: omhoog)
Verlaging voor verticale belasting	-6,0 m	-6,0 m	(negatief: omlaag, grotere weight span)
Verlaging:	Niet in 0,9EG-combinaties		

Hoogteafwijking mastbeeld naastgelegen masten en richtingsverandering t.o.v. Lijnrichting

Circuits	Aanduiding	Nummer	Hoogteverschil		Richtingsverandering	
			Δh_{back}	Δh_{ahead}	Δy_{back}	Δy_{ahead}
Circuit 1	10	380ct1f1	0,0	0,0 m	0,0	0,0 m
Circuit 1	11	380ct1f2	0,0	0,0 m	0,0	0,0 m
Circuit 1	12	380ct1f3	0,0	0,0 m	0,0	0,0 m
Circuit 2	20	380ct2f1	0,0	0,0 m	0,0	0,0 m
Circuit 2	21	380ct2f2	0,0	0,0 m	0,0	0,0 m
Circuit 2	22	380ct2f3	0,0	0,0 m	0,0	0,0 m
Circuit 3	30	150ct3f1	0,0	0,0 m	0,0	0,0 m
Circuit 3	31	150ct3f2	0,0	0,0 m	0,0	0,0 m
Circuit 3	32	150ct3f3	0,0	0,0 m	0,0	0,0 m
Circuit 4	40	150ct4f1	0,0	0,0 m	0,0	0,0 m
Circuit 4	41	150ct4f2	0,0	0,0 m	0,0	0,0 m
Circuit 4	42	150ct4f3	0,0	0,0 m	0,0	0,0 m
Bliksemdraad 1	1	bl1	0,0	0,0 m	0,0	0,0 m
Bliksemdraad 2	3	bl2	0,0	0,0 m	0,0	0,0 m

Lijn- en mastgegevens

	Back	Ahead
Ruling span $\sqrt{(\Sigma L^3/\Sigma L)}$	400,0	400,0 m
Lijnhoek	180 °	
Rotatie mast t.o.v. bissectrice	θ	0 °
Vaklengte	800	800 m
Hoogte onderkant mast t.o.v. maaiveld	0,5 m	
Beschouwde windrichtingen	α_1	0 °
Windrichtingen volgens:	α_2	45 °
<i>Geleiderbelastingen</i>	α_3	90 °
	α_4	135 °
	α_5	- °
	α_6	- °

Windrichtingen gelden t.o.v. hoofdrichting mastconstructie, niet t.o.v. bissectrice.

Windrichtingen en positieve richtingen belastingen

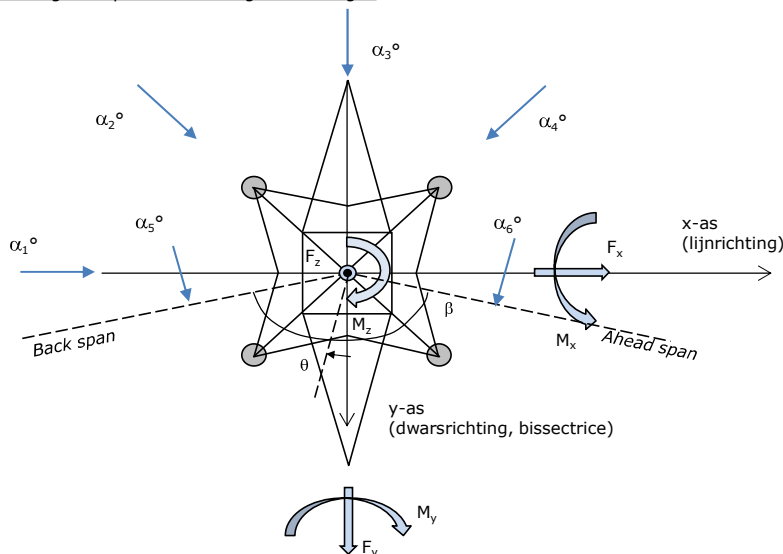

Beschouwd aantal windrichtingen	
1a	4
3	4
4	1
6	1
Overig	1

Project: RLL-TLB380
 Tower: S+3_c
 Number: 1104

Geleiderafval

		SPLS - torsie		SPLS - Enkelzijdige trek		5a - geleiderbreuk	
		Aanw.	Afw.	Aanw.	Afw.	Aanw.	Afw.
Circuit 1	380ct1f1	1	0	1	0	0,8	0
Circuit 1	380ct1f2	1	0	1	0	0,8	0
Circuit 1	380ct1f3	1	0	1	0	0,8	0
Circuit 2	380ct2f1	0	1	1	0	0,8	0
Circuit 2	380ct2f2	0	1	1	0	0,8	0
Circuit 2	380ct2f3	0	1	1	0	0,8	0
Circuit 3	150ct3f1	1	0	1	0	0,8	0
Circuit 3	150ct3f2	1	0	1	0	0,8	0
Circuit 3	150ct3f3	1	0	1	0	0,8	0
Circuit 4	150ct4f1	0	1	1	0	0,8	0
Circuit 4	150ct4f2	0	1	1	0	0,8	0
Circuit 4	150ct4f3	0	1	1	0	0,8	0
Bliksemdraad 1	b1	1	0	1	0	1	0
Bliksemdraad 2	b2	0	1	1	0	1	0

Belastingsituaties SPLS

Beschouwde situaties SPLS: SPLS voor steunmast niet van toepassing

Principe belastingssituaties:

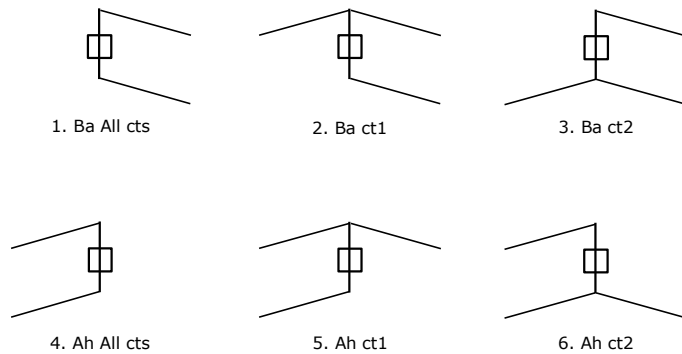

Belastingsituaties 5a. Geleiderbreuk

Beschouwde situaties geleiderbreuk 5a: 1 en 2, alle mogelijke situaties.

Principe belastingssituaties:

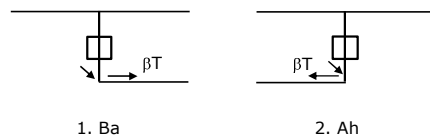

Project: RLL-TLB380
 Tower: S+3_c
 Number: 1104

Belastingsituaties 6. Bouw- en onderhoud

Onder 6a wordt de belasting door aanwezigheid lijnwagen of lijnfiets in combinatie met puntlast op traverse in rekening gebracht. Combinatie 6b bevat geen belastingen in geleider of op traverse. Deze combinatie is toegevoegd om te kunnen combineren met separate controle bordessen etc. De situaties worden in ULS en in iedere SPLS-situatie (in geval van hoekmast) toegepast.

	Fase	Bliksem
Lijnwagen	4,0 kN	2,0 kN
Puntlast op traverse	1,0 kN	1,0 kN

Beschouwde situaties bouw- en onderhoud 6a: 1 t/m 4, alle mogelijke situaties.

Aanwezigheid lijnwagen: Circuit, belasting tegelijk aanwezig in alle geleiders per circuit.

Principe belastingssituaties:

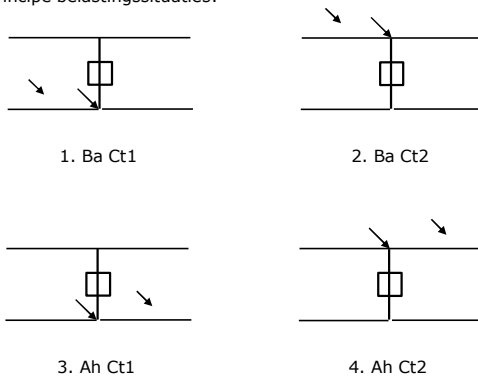

Belastingsituaties 8. Lijndansen als statische belasting

Geleider		
Steunmast fase	0,866 W	1,5 W
Steunmast bliksem	1,5 EDS	1,5 W
Hoekmast fase en bliksem	1,5 EDS	1,5 W

Considered situations galloping 8: 1 and 2, all possible situations

Belasting tegelijk aanwezig in alle geleiders van het circuit.

Principe belastingssituaties:

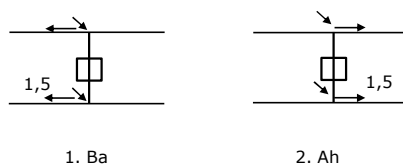

Belastingcombinatie 8. Lijndansen als dynamische belasting

Alleen van toepassing op hoek- en eindmasten
 Belasting bestaat uit EDS-trekbelasting in één van de geleiders aan één zijde van de mast
 Door gebruiker via het belastingsspectrum van tabel 4.11/NL.1 om te zetten naar spanningspectrum

Project: RLL-TLB380
 Tower: S+3_c
 Number: 1104

Mastconstructie

Eigenschappen

Masttype	Steunmast
Mastbenaming	S+3_c
Voetplaat t.o.v. maaiveld	0,5 m
Masthoogte t.o.v. voetplaat	59,7 m
Gewicht mast	458,0 kN

<i>Breedte en helling mast bij fundatie</i>	x-ri.	y-ri.
Pootsprei	10,24	10,24 m
Helling van de randstijl	0,150	0,150 -
Factor spatkracht	1,1	1,1 -

Berekening windbelasting

Dynamische invloed G_T	1,00 (<i>Masthoogte < 60 m</i>)
Windbelasting overhoeks op mastlichaam evenredig met:	$(A1C1\sin^2(\phi)+A2C2\cos^2(\phi))$
Windbelasting overhoeks op traverse evenredig met:	$(A1C1\sin^2(\phi)+A2C2\cos^2(\phi))$
Vergroting wind overhoeks mastlichaam	$(1+0,2\sin^2(2\phi))$
Vergroting wind overhoeks traverse	$(1+0,2\sin^2(2\phi))$
Factor wind evenwijdig t.o.v. haaks op traverse	0,4

Eigenschappen mastsecties langsrichting (vooraanzicht, yz-vlak)

Omschrijving	h [m]	b ₁ [m]	b ₂ [m]	Δh [m]	Δ _x [m]	A ₀ [m ²]	A ₁ [m ²]	χ = A ₁ /A ₀ [-]	C _t
Broekstuk	14,40	10,24	5,92	14,40	0,150	116,38	18,75	0,16	3,11
Eerste tussenstuk	27,10	5,92	4,55	12,70	0,054	66,50	14,15	0,21	2,88
Tweede tussenstuk	35,90	4,55	3,60	8,80	0,054	35,86	10,13	0,28	2,60
Bovenstuk 1	45,40	3,60	2,92	9,50	0,036	30,97	9,99	0,32	2,46
Bovenstuk 2	58,00	2,92	2,01	12,60	0,036	31,06	9,61	0,31	2,50
Topstuk	59,70	2,01		1,70		1,71	0,32	0,18	3,00
Ondertraverse	35,90	12,70		3,00		19,05	4,75	0,25	2,72
Middentraverse	45,40	16,34		3,00		24,51	6,81	0,28	2,62
Boventraverse	55,40	13,70	1,00	2,60		24,66	6,19	0,25	2,72

Eigenschappen mastsecties dwarsrichting (zijaanzicht, xz-vlak)

Omschrijving	h [m]	b ₁ [m]	b ₂ [m]	Δh [m]	Δ _x [m]	A ₀ [m ²]	A ₁ [m ²]	χ = A ₁ /A ₀ [-]	C _t
Broekstuk	14,40	10,24	5,92	14,40	0,150	116,38	18,75	0,16	3,11
Eerste tussenstuk	27,10	5,92	4,55	12,70	0,054	66,50	14,15	0,21	2,88
Tweede tussenstuk	35,90	4,55	3,60	8,80	0,054	35,86	10,13	0,28	2,60
Bovenstuk 1	45,40	3,60	2,92	9,50	0,036	30,97	9,99	0,32	2,46
Bovenstuk 2	58,00	2,92	2,01	12,60	0,036	31,06	9,61	0,31	2,50
Topstuk	59,70	2,01		1,70		1,71	0,32	0,18	3,00
Ondertraverse	35,90	12,70		3,00		19,05	4,75	0,25	2,72
Middentraverse	45,40	16,34		3,00		24,51	6,81	0,28	2,62
Boventraverse	55,40	13,70	1,00	2,60		24,66	6,19	0,25	2,72

NB: oppervlakte traverse dwarsrichting wordt in berekening gereduceerd.

Project: RLL-TLB380
 Tower: S+3_c
 Number: 1104

Windoppervlak feeders telecominstallaties

Onderdeel	A (m ² /m)	Factor	Δh	A ₁
Broekstuk	0,14	0,71	14,4	1,4
Eerste tussenstuk	0,14	0,71	12,7	1,3
Tweede tussenstuk	0,14	0,71	8,8	0,9
Bovenstuk 1	0,14	0,71	9,5	0,9
Bovenstuk 2				

Invoer antennes

Omschrijving	A (m ²)	h (m)	C _r (m)
Antenne top			
Antenne o.t.	4,7	42,2	1,5

Belastingen mastsectie langsrichting (x-richting) per windrichting

Omschrijving	P _w [kN/m ²]	F _{x1} [kN]	F _{x2} [kN]	F _{x3} [kN]	F _{x4} [kN]	h _{ef} [m]	M _{y1} [kNm]	M _{y2} [kNm]	M _{y3} [kNm]	M _{y4} [kNm]
Broekstuk	0,70	40,8	34,6	0,0	-34,6	7,2	293,9	249,4	0,0	-249,4
Eerste tussenstuk	0,89	36,1	30,6	0,0	-30,6	20,8	749,3	635,8	0,0	-635,8
Tweede tussenstuk	1,00	26,4	22,4	0,0	-22,4	31,5	830,7	704,9	0,0	-704,9
Bovenstuk 1	1,08	26,5	22,4	0,0	-22,4	40,7	1075,5	912,6	0,0	-912,6
Bovenstuk 2	1,15	27,5	23,4	0,0	-23,4	51,7	1423,9	1208,2	0,0	-1208,2
Topstuk	1,18	1,1	1,0	0,0	-1,0	58,9	66,0	56,0	0,0	-56,0
Ondertraverse	1,05	27,1	16,1	0,0	-16,1	36,9	1000,5	594,3	0,0	-594,3
Middentraverse	1,11	39,7	23,6	0,0	-23,6	46,4	1840,7	1093,3	0,0	-1093,3
Boventraverse	1,17	39,4	23,4	0,0	-23,4	56,3	2217,0	1316,8	0,0	-1316,8
Totaal		264,6	197,5	0,0	-197,5		9497,5	6771,3	0,0	-6771,3

Belastingen mastsectie dwarsrichting (y-richting) per windrichting

Omschrijving	P _w [kN/m ²]	F _{y1} [kN]	F _{y2} [kN]	F _{y3} [kN]	F _{y4} [kN]	h _{ef} [m]	M _{x1} [kNm]	M _{x2} [kNm]	M _{x3} [kNm]	M _{x4} [kNm]
Broekstuk	0,70	0,0	34,6	40,8	34,6	7,2	0,0	249,4	293,9	249,4
Eerste tussenstuk	0,89	0,0	30,6	36,1	30,6	20,8	0,0	635,8	749,3	635,8
Tweede tussenstuk	1,00	0,0	22,4	26,4	22,4	31,5	0,0	704,9	830,7	704,9
Bovenstuk 1	1,08	0,0	22,4	26,5	22,4	40,7	0,0	912,6	1075,5	912,6
Bovenstuk 2	1,15	0,0	23,4	27,5	23,4	51,7	0,0	1208,2	1423,9	1208,2
Topstuk	1,18	0,0	1,0	1,1	1,0	58,9	0,0	56,0	66,0	56,0
Ondertraverse	1,05	0,0	16,1	10,8	16,1	36,9	0,0	594,3	400,2	594,3
Middentraverse	1,11	0,0	23,6	15,9	23,6	46,4	0,0	1093,3	736,3	1093,3
Boventraverse	1,17	0,0	23,4	15,8	23,4	56,3	0,0	1316,8	886,8	1316,8
Totaal		0,0	197,5	200,9	197,5		0,0	6771,3	6462,6	6771,3

Resulterende belastingen vanuit mastconstructie incl. antenne zonder geleiders niveau fundatie (kar. waarde)

Belasting / windrichting	F _x [kN]	F _y [kN]	F _z [kN]	M _x [kNm]	M _y [kNm]	M _z [kNm]
Permanente belasting	0	0	458	0	0	0
Windrichting 0°	272	0	0	0	9821	0
Windrichting 45°	203	203	0	7000	7000	0
Windrichting 90°	0	209	0	6786	0	0
Windrichting 135°	-203	203	0	7000	-7000	0

Project: RLL-TLB380
 Tower: S+3_c
 Number: 1104

Tussenresultaten geleiderbelastingen

Geleiders back

Circuit	Geleider	Diameter [mm]	A [mm ²]	G [N/m]	E [N/mm ²]	αT [-]
Circuit 1	AAAC-AL7 620	32,4	621,0	17,71	56000	2,30E-05
Circuit 2	AAAC-AL7 620	32,4	621,0	17,71	56000	2,30E-05
Circuit 3	AAAC-AL7 620	32,4	621,0	17,71	56000	2,30E-05
Circuit 4	AAAC-AL7 620	32,4	621,0	17,71	56000	2,30E-05
Bliksemdraad 1	AACSR 241-AL3-39-A20SA	21,8	281,0	9,38	70165	1,97E-05
Bliksemdraad 2	OPGW AFL-226/38	21,7	264,0	9,13	72000	1,98E-05

Geleiders ahead

Circuit	Geleider	Diameter [mm]	A [mm ²]	G [N/m]	E [N/mm ²]	αT [-]
Circuit 1	AAAC-AL7 620	32,4	621,0	17,71	56000	2,30E-05
Circuit 2	AAAC-AL7 620	32,4	621,0	17,71	56000	2,30E-05
Circuit 3	AAAC-AL7 620	32,4	621,0	17,71	56000	2,30E-05
Circuit 4	AAAC-AL7 620	32,4	621,0	17,71	56000	2,30E-05
Bliksemdraad 1	AACSR 241-AL3-39-A20SA	21,8	281,0	9,38	70165	1,97E-05
Bliksemdraad 2	OPGW AFL-226/38	21,7	264,0	9,13	72000	1,98E-05

Verticale belasting back

Circuit	Bundel [-]	Toeslag [%]	$w_{z,G}$ [N/m]	IJsg gebied	Formule	$w_{z,ijs}$ [N/m]	$w_{z,ijs,bundel}$ [N/m]
Circuit 1	4	3	73,0	B	4+0,2d	10,5	41,9
Circuit 2	4	3	73,0	B	4+0,2d	10,5	41,9
Circuit 3	2	3	36,5	B	4+0,2d	10,5	21,0
Circuit 4	2	3	36,5	B	4+0,2d	10,5	21,0
Bliksemdraad 1	1	2	9,6	A	15+0,4d	23,7	23,7
Bliksemdraad 2	1	2	9,3	A	15+0,4d	23,7	23,7

Verticale belasting ahead

Circuit	Bundel [-]	Toeslag [%]	$w_{z,G}$ [N/m]	IJsg gebied	Formule	$w_{z,ijs}$ [N/m]	$w_{z,ijs,bundel}$ [N/m]
Circuit 1	4	3	73,0	B	4+0,2d	10,5	41,9
Circuit 2	4	3	73,0	B	4+0,2d	10,5	41,9
Circuit 3	2	3	36,5	B	4+0,2d	10,5	21,0
Circuit 4	2	3	36,5	B	4+0,2d	10,5	21,0
Bliksemdraad 1	1	2	9,6	A	15+0,4d	23,7	23,7
Bliksemdraad 2	1	2	9,3	A	15+0,4d	23,7	23,7

Isolatoren

Geleider	$G_{isolator}$ [kN]	Aantal	$F_{V,iso}$ [kN]	Lengte [m]	Windopp. [m ²]	Windhoogte [m]	Stuwdruk [kN/m ²]	Vormfactor	$F_{th,iso}$ [kN]
380ct1f1	4,50	1	4,5	4,5	2,0	34,15	1,02	1,2	2,46
380ct1f2	4,50	1	4,5	4,5	2,0	43,65	1,10	1,2	2,63
380ct1f3	4,50	1	4,5	4,5	2,0	53,65	1,16	1,2	2,78
380ct2f1	4,50	1	4,5	4,5	2,0	34,15	1,02	1,2	2,46
380ct2f2	4,50	1	4,5	4,5	2,0	43,65	1,10	1,2	2,63
380ct2f3	4,50	1	4,5	4,5	2,0	53,65	1,16	1,2	2,78
150ct3f1	2,50	1	2,5	4,0	1,0	34,40	1,03	1,2	1,23
150ct3f2	2,50	1	2,5	4,0	1,0	43,90	1,10	1,2	1,32
150ct3f3	2,50	1	2,5	4,0	1,0	53,90	1,16	1,2	1,39
150ct4f1	2,50	1	2,5	4,0	1,0	34,40	1,03	1,2	1,23
150ct4f2	2,50	1	2,5	4,0	1,0	43,90	1,10	1,2	1,32
150ct4f3	2,50	1	2,5	4,0	1,0	53,90	1,16	1,2	1,39
bl1	0,10	1	0,1	0,2	0,1	57,30	1,18	1,2	0,14
bl2	0,10	1	0,1	0,2	0,1	57,30	1,18	1,2	0,14

Project: RLL-TLB380
 Tower: S+3_c
 Number: 1104

Windbelasting back

Geleider	hoogte		G _{c,dwars}	G _{c,trek}	C _c	d _{toeslag}	W _y	W _{y,vak}	D _{ijs,toeslag}	W _{y,ijs}	W _{y,ijs,vak}
	wind	Stuwdruk									
	[m]	[kN/m ²]	[-]	[-]	[-]	[mm]	[N/m]	[N/m]	[mm]	[N/m]	[N/m]
380ct1f1	27,5	0,96	0,57	0,57	1,01	33,37	74,4	74,4	51,8	136,8	136,8
380ct1f2	37,0	1,05	0,59	0,59	0,99	33,37	81,9	81,9	51,8	154,8	154,8
380ct1f3	47,0	1,12	0,61	0,61	0,97	33,37	88,1	88,1	51,8	170,2	170,2
380ct2f1	27,5	0,96	0,57	0,57	1,01	33,37	74,4	74,4	51,8	136,8	136,8
380ct2f2	37,0	1,05	0,59	0,59	0,99	33,37	81,9	81,9	51,8	154,8	154,8
380ct2f3	47,0	1,12	0,61	0,61	0,97	33,37	88,1	88,1	51,8	170,2	170,2
150ct3f1	28,0	0,97	0,57	0,57	1,01	33,37	37,4	37,4	51,8	68,9	68,9
150ct3f2	37,5	1,05	0,59	0,59	0,99	33,37	41,1	41,1	51,8	77,8	77,8
150ct3f3	47,5	1,12	0,61	0,61	0,96	33,37	44,2	44,2	51,8	85,5	85,5
150ct4f1	28,0	0,97	0,57	0,57	1,01	33,37	37,4	37,4	51,8	68,9	68,9
150ct4f2	37,5	1,05	0,59	0,59	0,99	33,37	41,1	41,1	51,8	77,8	77,8
150ct4f3	47,5	1,12	0,61	0,61	0,96	33,37	44,2	44,2	51,8	85,5	85,5
bl1	52,8	1,15	0,62	0,62	1,18	22,24	18,8	18,8	63,1	54,2	54,2
bl2	52,8	1,15	0,62	0,62	1,18	22,13	18,8	18,8	63,0	54,2	54,2

Windbelasting ahead

Geleider	hoogte		G _{c,dwars}	G _{c,trek}	C _c	d _{toeslag}	W _y	W _{y,vak}	D _{ijs,toeslag}	W _{y,ijs}	W _{y,ijs,vak}
	wind	Stuwdruk									
	[m]	[kN/m ²]	[-]	[-]	[-]	[mm]	[N/m]	[N/m]	[mm]	[N/m]	[N/m]
380ct1f1	27,5	0,96	0,57	0,57	1,01	33,37	74,4	74,4	51,8	136,8	136,8
380ct1f2	37,0	1,05	0,59	0,59	0,99	33,37	81,9	81,9	51,8	154,8	154,8
380ct1f3	47,0	1,12	0,61	0,61	0,97	33,37	88,1	88,1	51,8	170,2	170,2
380ct2f1	27,5	0,96	0,57	0,57	1,01	33,37	74,4	74,4	51,8	136,8	136,8
380ct2f2	37,0	1,05	0,59	0,59	0,99	33,37	81,9	81,9	51,8	154,8	154,8
380ct2f3	47,0	1,12	0,61	0,61	0,97	33,37	88,1	88,1	51,8	170,2	170,2
150ct3f1	28,0	0,97	0,57	0,57	1,01	33,37	37,4	37,4	51,8	68,9	68,9
150ct3f2	37,5	1,05	0,59	0,59	0,99	33,37	41,1	41,1	51,8	77,8	77,8
150ct3f3	47,5	1,12	0,61	0,61	0,96	33,37	44,2	44,2	51,8	85,5	85,5
150ct4f1	28,0	0,97	0,57	0,57	1,01	33,37	37,4	37,4	51,8	68,9	68,9
150ct4f2	37,5	1,05	0,59	0,59	0,99	33,37	41,1	41,1	51,8	77,8	77,8
150ct4f3	47,5	1,12	0,61	0,61	0,96	33,37	44,2	44,2	51,8	85,5	85,5
bl1	52,8	1,15	0,62	0,62	1,18	22,24	18,8	18,8	63,1	54,2	54,2
bl2	52,8	1,15	0,62	0,62	1,18	22,13	18,8	18,8	63,0	54,2	54,2

Project: RLL-TLB380
 Masttype: S+3_c
 Mast: 1104

Auteur: TBR
 Versie: v11.8

Geleiderbelastingen

Uitgangspunten
 Betrouwbaarheidsniveau Nieuwbouw CC2
 Referentieperiode 50 jaar

ULS (bezwijksterkte)		NEN-EN50341-2-15:2019						
Belastingsgeval	omschrijving	Temp °C	γ_G		γ_Q			γ_a A_k
			$G_{k,mast}$	$G_{k,geleider}$	Q_{pk}	Q_{wk}	Q_{ik}	
ULS 1a	Wind	10°	1,20	1,20	0,00	1,50	0,00	0,0
ULS 1a_0,9	Wind 0,9Gk alleen mast	10°	0,90	1,20	0,00	1,50	0,00	0,0
ULS 1a_0,9_0,9	Wind 0,9Gk ook geleider	10°	0,90	0,90	0,00	1,50	0,00	0,0
ULS 3	Wind+ijs	-5°	1,20	1,20	0,00	0,45	1,50	0,0
ULS 3_0,9	Wind+ijs 0,9	-5°	0,90	1,20	0,00	0,45	1,50	0,0
ULS 4	Koude+wind	-20°	1,20	1,20	0,00	0,30	0,00	0,0
ULS 4_0,9	Koude+wind 0,9	-20°	0,90	1,20	0,00	0,30	0,00	0,0
ULS 5a	Torsiebelastingen	10°	1,00	1,00	1,00	0,00	0,00	1,0
ULS 5b	Longitudinale belastingen	10°	1,00	1,00	0,00	0,00	0,00	1,0
ULS 6	Bouw en onderhoud	5°	1,20	1,20	1,50	0,30	0,00	0,0
ULS 6_0,9	Bouw en onderhoud	5°	1,20	1,20	0,00	0,30	0,00	0,0
ULS 7	Permanent	10°	1,35	1,35	0,00	0,00	0,00	0,0
ULS 8	Special	10°	1,00	1,00	0,00	0,00	0,00	1,0
SPLS (Bezwijksterkte, enkel voor hoekmasten: afwezigheid geleiders)			γ_G		γ_Q			
			G_k		Q_{pk}	Q_{wk}	Q_{ik}	A_k
SPLS 1a	Wind	10°	1,20	1,20	0,0	0,78	0,00	0,0
SPLS 1a_0,9	Wind 0,9	10°	0,90	1,20	0,0	0,78	0,00	0,0
SPLS 1a_0,9_0,9	Wind 0,9	10°	0,90	0,90	0,0	0,78	0,00	0,0
SPLS 3	Wind+ijs	-5°	1,20	1,20	0,0	0,36	0,34	0,0
SPLS 3_0,9	Wind+ijs 0,9	-5°	0,90	1,20	0,0	0,36	0,34	0,0
SPLS 4	Koude+wind	-20°	1,20	1,20	0,0	0,24	0,00	0,0
SPLS 4_0,9	Koude+wind 0,9	-20°	0,90	1,20	0,0	0,24	0,00	0,0
SPLS 6	Bouw en onderhoud	5°	1,20	1,20	1,2	0,24	0,0	0,0
SPLS 6_0,9	Bouw en onderhoud	5°	1,20	1,20	0,0	0,24	0,0	0,0
SLS (controle van de vervormingen, vermoeiing, EDS)			G_k		Q_{pk}	Q_{wk}	Q_{ik}	A_k
SLS 1a	Wind	10°	1,00	1,00	0,0	1,00	0,0	0,0
SLS 3	Wind+ijs	-5°	1,00	1,00	0,0	0,30	1,00	0,0
SLS 4	Wind	-20°	1,00	1,00	0,0	0,20	0,0	0,0
SLS 6	Bouw en onderhoud	5°	1,00	1,00	0,0	0,20	0,0	0,0
SLS 7	PB (EDS, geen wind)	10°	1,00	1,00	0,0	0,00	0,0	0,0

Aantal windrichtingen 4
 Aantal belastingcombinaties ULS 62
 Aantal belastingcombinaties SPLS 0
 Aantal belastingcombinaties SLS 11
 Aantal knooplasten 1022

Project: RLL-TLB380
 Masttype: S+3_c
 Mast: 1104

Samenvattingstabellen geleiderbelastingen

In de onderstaande vier tabellen is weergegeven:

- De maximale geleiderbelasting in het globale assenstelsel, gesplitst in aandeel van back en ahead span
- De gecombineerde geleiderbelasting (Ba+Ah) in het globale assenstelsel met in het lokale assenstelsel de maximaal optredende trekkracht. Componenten Fx en Fy als absolute waarde
- De alledaagse (EDS) waarden van de gecombineerde geleiderbelastingen (Ba+Ah) met bijbehorende trekkrachten
- Controle op uplift, waar een negatieve waarde duidt op uplift

Maximale waarden voor back en ahead span

Geleider	Fx_ba [kN]	Fx_ah [kN]	Fy_ba [kN]	Fy_ah [kN]	Fz_ba [kN]	Fz_ah [kN]
bl1	-66,4	66,4	5,7	5,7	10,5	10,5
380ct1f1	-258,8	258,8	24,2	24,2	36,7	36,7
380ct1f2	-262,6	262,6	26,6	26,6	36,7	36,7
380ct1f3	-266,2	266,2	28,5	28,5	36,8	36,8
380ct2f1	-258,8	258,8	24,2	24,2	36,7	36,7
380ct2f2	-262,6	262,6	26,6	26,6	36,7	36,7
380ct2f3	-266,2	266,2	28,5	28,5	36,8	36,8
150ct3f1	-129,5	129,5	12,2	12,2	18,8	18,8
150ct3f2	-131,4	131,4	13,3	13,3	18,8	18,8
150ct3f3	-133,2	133,2	14,3	14,3	18,8	18,8
150ct4f1	-129,5	129,5	12,2	12,2	18,8	18,8
150ct4f2	-131,4	131,4	13,3	13,3	18,8	18,8
150ct4f3	-133,2	133,2	14,3	14,3	18,8	18,8
bl2	-65,4	65,4	5,7	5,7	10,4	10,4

Min. Weight span (m)

Weight spar Combinatie1

Geleider	SLS 1a	SLS 4	SLS 7
bl1	454,0	464,9	454,0
380ct1f1	454,0	463,7	454,0
380ct1f2	454,0	463,9	454,0
380ct1f3	454,0	464,1	454,0
380ct2f1	454,0	463,7	454,0
380ct2f2	454,0	463,9	454,0
380ct2f3	454,0	464,1	454,0
150ct3f1	454,0	463,8	454,0
150ct3f2	454,0	464,0	454,0
150ct3f3	454,0	464,1	454,0
150ct4f1	454,0	463,8	454,0
150ct4f2	454,0	464,0	454,0
150ct4f3	454,0	464,1	454,0
bl2	454,0	465,1	454,0

Max. Weight span (m)

Weight spar Combinatie1

Geleider	ULS 1a	ULS 3
bl1	512,2	442,3
380ct1f1	476,2	451,6
380ct1f2	479,9	452,4
380ct1f3	483,0	453,1
380ct2f1	476,2	451,6
380ct2f2	479,9	452,4
380ct2f3	483,0	453,1
150ct3f1	476,4	451,7
150ct3f2	480,1	452,4
150ct3f3	483,2	453,1
150ct4f1	476,4	451,7
150ct4f2	480,1	452,4
150ct4f3	483,2	453,1
bl2	513,8	442,0

Omhullende weight span over alle combinaties (incl. 0,9 combinaties)

Voor alle geleiders

Max. weight span	513,8 m
Min. weight span	251,8 m

Wind / Weight span verhouding

	1,284 -
	0,629 -

Project: RLL-TLB380
 Masttype: S+3_c
 Mast: 1104

Maximale waarden back+ahead span Maximale waarden trekkracht geleider

Geleider	Fx	Fy	Fz	Ft_ba	Ft_ah
	[kN]	[kN]	[kN]	[kN]	[kN]
bl1	25,8	11,5	20,9	-66,4	66,4
380ct1f1	105,1	48,3	73,3	-258,8	258,8
380ct1f2	105,1	53,1	73,5	-262,6	262,6
380ct1f3	105,1	57,1	73,6	-266,2	266,2
380ct2f1	105,1	48,3	73,3	-258,8	258,8
380ct2f2	105,1	53,1	73,5	-262,6	262,6
380ct2f3	105,1	57,1	73,6	-266,2	266,2
150ct3f1	52,5	24,3	37,0	-129,5	129,5
150ct3f2	52,5	26,7	37,0	-131,4	131,4
150ct3f3	52,5	28,6	37,1	-133,2	133,2
150ct4f1	52,5	24,3	37,0	-129,5	129,5
150ct4f2	52,5	26,7	37,0	-131,4	131,4
150ct4f3	52,5	28,6	37,1	-133,2	133,2
bl2	25,1	11,5	20,8	-65,4	65,4

EDS-belastingen geleiders

Geleider	Fx	Fy	Fz	Ft_ba	Ft_ah
	[kN]	[kN]	[kN]	[kN]	[kN]
bl1	0,0	0,0	4,4	-17,2	17,2
380ct1f1	0,0	0,0	37,6	-131,3	131,3
380ct1f2	0,0	0,0	37,6	-131,3	131,3
380ct1f3	0,0	0,0	37,6	-131,3	131,3
380ct2f1	0,0	0,0	37,6	-131,3	131,3
380ct2f2	0,0	0,0	37,6	-131,3	131,3
380ct2f3	0,0	0,0	37,6	-131,3	131,3
150ct3f1	0,0	0,0	19,1	-65,7	65,7
150ct3f2	0,0	0,0	19,1	-65,7	65,7
150ct3f3	0,0	0,0	19,1	-65,7	65,7
150ct4f1	0,0	0,0	19,1	-65,7	65,7
150ct4f2	0,0	0,0	19,1	-65,7	65,7
150ct4f3	0,0	0,0	19,1	-65,7	65,7
bl2	0,0	0,0	4,3	-16,8	16,8

Controle uplift SLS-wind

Combinatie: Geleider	Fz_ba	Fz_ah
	[kN]	[kN]
SLS 4		
bl1	2,3	2,3
380ct1f1	19,2	19,2
380ct1f2	19,2	19,2
380ct1f3	19,2	19,2
380ct2f1	19,2	19,2
380ct2f2	19,2	19,2
380ct2f3	19,2	19,2
150ct3f1	9,7	9,7
150ct3f2	9,7	9,7
150ct3f3	9,7	9,7
150ct4f1	9,7	9,7
150ct4f2	9,7	9,7
150ct4f3	9,7	9,7
bl2	2,2	2,2

Project: RLL-TLB380
 Masttype: S+3_c
 Mast: 1104

ULS-fundatiebelasting combinatie 1 en 3 wind haaks op de lijn of bissectrice en EDS, vanuit geleiders

Combinatie	Combination	F_x [kN]	F_y [kN]	F_z [kN]	M_x [kNm]	M_y [kNm]	M_z [kNm]
ULS 1a_90		0	499	440	23261	0	0
ULS 1a_0,9_90		0	499	309	23260	0	0
ULS 3_90		0	280	705	13169	0	0
ULS 3_0,9_90		0	280	555	13168	0	0
SLS 7		0	0	349	2	0	0

ULS-fundatiebelasting combinatie 1 en 3 wind haaks op de lijn of bissectrice en EDS, totaal geleiders en mast

Combinatie	F_x [kN]	F_y [kN]	F_z [kN]	M_x [kNm]	M_y [kNm]	M_z [kNm]
ULS 1a_90	0	812	990	33439	0	0
ULS 3_90	0	374	1254	16223	0	0
SLS 7	0	0	807	2	0	0

Fundatiebelastingen, selectie belastingcombinaties op basis grootste waarde

Combinatie	F_x [kN]	F_y [kN]	F_z [kN]	M_x [kNm]	M_y [kNm]	M_z [kNm]
ULS 1a_90	0	812	990	33439	0	0
ULS 1a_0	427	0	967	2	15569	0
ULS 5a Ba 11	105	0	804	-230	4770	1471
ULS 1a_45	317	561	974	22473	11092	0

Noot: grootste waarden kunnen in meerdere combinaties voorkomen, een combinatie is weergegeven.

Oplegreacties op fundering per randstijl

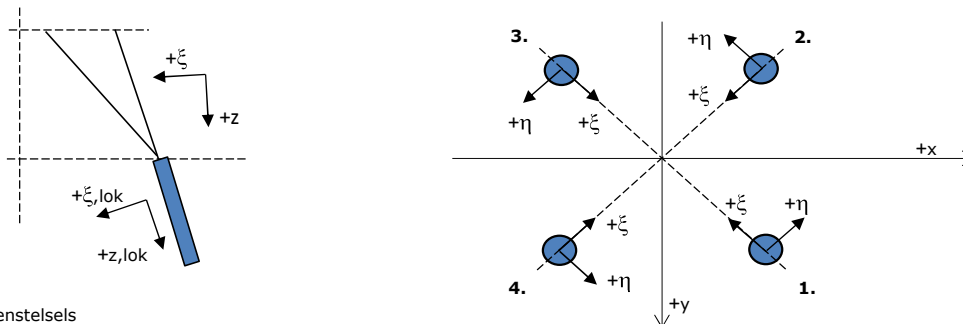

Assenstelsels

Maximale drukbelasting

Stijl	Combinatie	R_x [kN]	R_y [kN]	R_z [kN]	R_η [kN]	R_ξ [kN]	$R_{\xi,lok}$ [kN]	$R_{z,lok}$ [kN]
1	ULS 1a_45	301	270	1882	22	-403	-4	1924
2	ULS 1a_0	146	-165	1002	13	-220	-8	1024
3	ULS 8 Ba	-117	-158	956	-29	-194	9	977
4	ULS 1a_135	-301	270	1882	-22	-403	-4	1924

Maximale trekbelasting

Stijl	Combinatie	R_x [kN]	R_y [kN]	R_z [kN]	R_η [kN]	R_ξ [kN]	$R_{\xi,lok}$ [kN]	$R_{z,lok}$ [kN]
1	ULS 8 Ba	-38	-78	-476	29	82	-19	-486
2	ULS 1a_0,9_0,9_135	-234	203	-1476	22	309	-5	-1509
3	ULS 1a_0,9_0,9_45	234	203	-1476	-22	309	-5	-1509
4	ULS 1a_0,9_0,9_0	79	-98	-595	-13	126	-1	-608

Maximale torsiebelasting (positief)

Stijl	Combinatie	R_x [kN]	R_y [kN]	R_z [kN]	R_η [kN]	R_ξ [kN]	$R_{\xi,lok}$ [kN]	$R_{z,lok}$ [kN]
1	ULS 5a Ah 21	45	-41	-20	61	-3	-7	-21
2	ULS 5a Ba 11	25	-108	445	58	-94	0	455
3	ULS 5a Ba 11	-45	41	-21	61	-2	-7	-21
4	ULS 5a Ah 21	-25	108	445	58	-94	0	455

Maximale torsiebelasting (negatief)

Stijl	Combinatie	R_x [kN]	R_y [kN]	R_z [kN]	R_η [kN]	R_ξ [kN]	$R_{\xi,lok}$ [kN]	$R_{z,lok}$ [kN]
1	ULS 5a Ba 21	25	108	445	-58	-94	0	455
2	ULS 5a Ah 11	45	41	-21	-61	-2	-7	-21
3	ULS 5a Ah 11	-25	-108	445	-58	-94	0	455
4	ULS 5a Ba 21	-45	-41	-20	-61	-3	-7	-21

Project: RLL-TLB380
 Masttype: S+3_c
 Mast: 1104

Combinatie Ftrek+Fhor

Stijl	Combinatie	R _x [kN]	R _y [kN]	R _z [kN]	R _η [kN]	R _ξ [kN]	R _{ξ,lok} [kN]	R _{z,lok} [kN]
1	ULS 8 Ba	-38	-78	-476	29	82	-19	-486
2	ULS 1a_0,9_0,9_90	-243	177	-1474	47	297	-16	-1507
3	ULS 1a_0,9_0,9_90	243	177	-1474	-47	297	-16	-1507
4	ULS 1a_0,9_0,9_0	79	-98	-595	-13	126	-1	-608

Permanente belasting

Stijl	Combinatie	R _x [kN]	R _y [kN]	R _z [kN]	R _η [kN]	R _ξ [kN]	R _{ξ,lok} [kN]	R _{z,lok} [kN]
1	SLS 7	33	33	202	0	-47	-4	206
2	SLS 7	33	-33	202	0	-47	-4	206
3	SLS 7	-33	-33	202	0	-47	-4	206
4	SLS 7	-33	33	202	0	-47	-4	206

Omhullenden ongeacht stijl

Belasting	Combinatie	R _x [kN]	R _y [kN]	R _z [kN]	R _η [kN]	R _ξ [kN]	R _{ξ,lok} [kN]	R _{z,lok} [kN]
Max. druk	ULS 1a_45	301	270	1882	22	-403	-4	1924
Max. trek	ULS 1a_0,9_0,9_45	234	203	-1476	-22	309	-5	-1509
Max. pos. torsie	ULS 5a Ah 21	45	-41	-20	61	-3	-7	-21
Max. neg. torsie	ULS 5a Ba 21	-45	-41	-20	-61	-3	-7	-21
Comb. trek+torsie	ULS 1a_0,9_0,9_90	-243	177	-1474	47	297	-16	-1507

Maximale trekbelasting SLS

Stijl	Combinatie	R _x [kN]	R _y [kN]	R _z [kN]	R _η [kN]	R _ξ [kN]	R _{ξ,lok} [kN]	R _{z,lok} [kN]
1	SLS 7	33	33	202	0	-47	-4	206
2	SLS 1a_135	-140	120	-890	14	184	-5	-909
3	SLS 1a_45	140	120	-890	-14	184	-5	-909
4	SLS 1a_0	38	-50	-305	-9	62	-2	-312

Maximale drukbelasting SLS

Stijl	Combinatie	R _x [kN]	R _y [kN]	R _z [kN]	R _η [kN]	R _ξ [kN]	R _{ξ,lok} [kN]	R _{z,lok} [kN]
1	SLS 1a_45	207	187	1295	14	-278	-4	1324
2	SLS 1a_0	104	-117	708	9	-156	-6	724
3	SLS 7	-33	-33	202	0	-47	-4	206
4	SLS 1a_135	-207	187	1295	-14	-278	-4	1324

Project: RLL-TLB380
Masttype: S+3_c
Mast: 1104

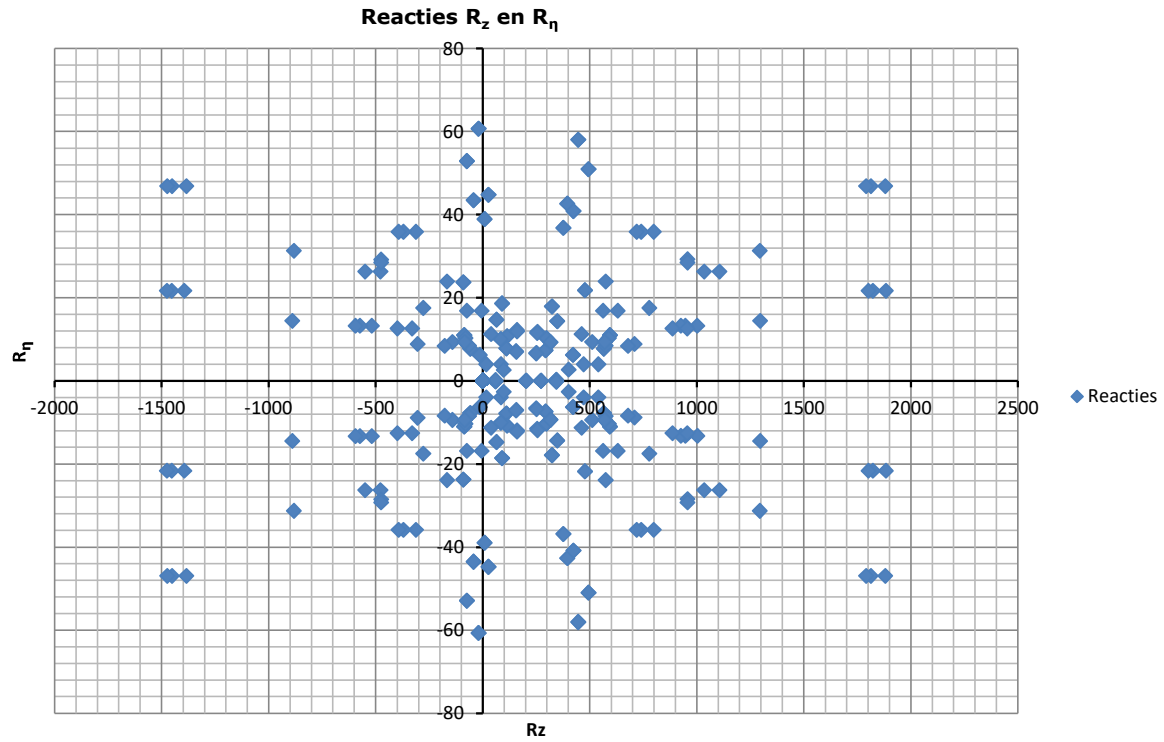

Project: RLL-TLB380
 Tower: S+6_c
 Number: 1101

Auteur: TBR
 Versie: v11.8

Geleiderbelastingen

Algemeen

Benaming S+6_c
 Masttype Steunmast
 Aantal circuits 4
 Configuratie 4-circuit-dubbel verticaal
 Aantal bliksemgeleiders 2

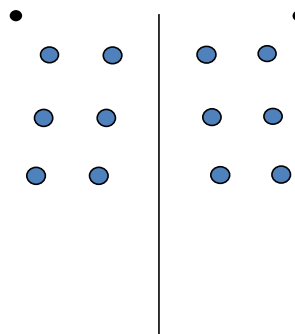

Configuratie geleiders

Uitgangspunten

Norm NEN-EN50341-2-15:2019
 Gevolgklasse initieel CC2
 Betrouwbaarheidsniveau initieel Nieuwbouw
 Referentieperiode initieel 50 jaar
 Referentieperiode na aanpassing 50 jaar
 Betrouwbaarheidsniveau na aanpassing n.v.t.
 Windgebied III
 Windsnelheid (m/s) 24,5 m/s
 Terreincategorie II
 Reductiefactor c_{dir} 1,00
 IJsg gebied fasegeleider B
 IJsg gebied bliksemgeleider A

Geleiders Back

Omschrijving	Spanning	Geleider Back	Bundel Ba	IJsg gebied	Toeslag gewicht	Toeslag diameter	Intrekwaarden P_{back}
Circuit 1	380 kV	AAAC-AL7 620	4	B	3 %	3 %	1800
Circuit 2	380 kV	AAAC-AL7 620	4	B	3 %	3 %	1800
Circuit 3	150 kV	AAAC-AL7 620	2	B	3 %	3 %	1800
Circuit 4	150 kV	AAAC-AL7 620	2	B	3 %	3 %	1800
Bliksemdraad 1		AACSR 241-AL3-39-A20SA	1	A	2 %	2 %	1800
Bliksemdraad 2		OPGW AFL-226/38	1	A	2 %	2 %	1800

Geleiders Ahead

Omschrijving	Spanning	Geleider Ahead	Bundel Ah	IJsg gebied	Toeslag gewicht	Toeslag diameter	Intrekwaarden P_{ahead}
Circuit 1	380 kV	AAAC-AL7 620	4	B	3 %	3 %	1800
Circuit 2	380 kV	AAAC-AL7 620	4	B	3 %	3 %	1800
Circuit 3	150 kV	AAAC-AL7 620	2	B	3 %	3 %	1800
Circuit 4	150 kV	AAAC-AL7 620	2	B	3 %	3 %	1800
Bliksemdraad 1		AACSR 241-AL3-39-A20SA	1	A	2 %	2 %	1800
Bliksemdraad 2		OPGW AFL-226/38	1	A	2 %	2 %	1800

Isolatoren (1)

Omschrijving	Ophanging	Gewicht [kN]	Lengte [m]	Windopp. [m ²]
Circuit 1	V-ketting	4,50	4,50	2,00
Circuit 2	V-ketting	4,50	4,50	2,00
Circuit 3	V-ketting	2,50	4,00	1,00
Circuit 4	V-ketting	2,50	4,00	1,00
Bliksemdraad 1	Vast (Bliksemdraad)	0,10	0,20	0,10
Bliksemdraad 2	Vast (Bliksemdraad)	0,10	0,20	0,10

1. Eigenschappen gelden voor geheel van de isolatorset

Ophanghoogte en positie in mast

Circuits	Aanduiding	Nummer	Ophanghoogte	Aangrippunt	Positie in mast Horizontale afstand
Circuit 1	10	380ct1f1	34,4 m	38,9 m	11,3 m
Circuit 1	11	380ct1f2	43,9 m	48,4 m	14,0 m
Circuit 1	12	380ct1f3	53,9 m	58,4 m	10,3 m
Circuit 2	20	380ct2f1	34,4 m	38,9 m	-11,3 m
Circuit 2	21	380ct2f2	43,9 m	48,4 m	-14,0 m
Circuit 2	22	380ct2f3	53,9 m	58,4 m	-10,3 m
Circuit 3	30	150ct3f1	34,9 m	38,9 m	5,0 m
Circuit 3	31	150ct3f2	44,4 m	48,4 m	7,7 m
Circuit 3	32	150ct3f3	54,4 m	58,4 m	4,0 m
Circuit 4	40	150ct4f1	34,9 m	38,9 m	-5,0 m
Circuit 4	41	150ct4f2	44,4 m	48,4 m	-7,7 m
Circuit 4	42	150ct4f3	54,4 m	58,4 m	-4,0 m
Bliksemdraad 1	1	bl1	59,7 m	59,9 m	16,0 m
Bliksemdraad 2	3	bl2	59,7 m	59,9 m	-16,0 m

Project: RLL-TLB380
 Tower: S+6_c
 Number: 1101

Hoogteaanpassing naastgelegen masten (aanpassing wind- en weight span)

	Back	Ahead	
Verhoging voor windbelasting	6,0 m	6,0 m	(positief: omhoog)
Verlaging voor verticale belasting	-6,0 m	-6,0 m	(negatief: omlaag, grotere weight span)
Verlaging:	Niet in 0,9EG-combinaties		

Hoogteafwijking mastbeeld naastgelegen masten en richtingsverandering t.o.v. Lijnrichting

Circuits	Aanduiding	Nummer	Hoogteverschil		Richtingsverandering	
			Δh_{back}	Δh_{ahead}	Δy_{back}	Δy_{ahead}
Circuit 1	10	380ct1f1	0,0	0,0 m	0,0	0,0 m
Circuit 1	11	380ct1f2	0,0	0,0 m	0,0	0,0 m
Circuit 1	12	380ct1f3	0,0	0,0 m	0,0	0,0 m
Circuit 2	20	380ct2f1	0,0	0,0 m	0,0	0,0 m
Circuit 2	21	380ct2f2	0,0	0,0 m	0,0	0,0 m
Circuit 2	22	380ct2f3	0,0	0,0 m	0,0	0,0 m
Circuit 3	30	150ct3f1	0,0	0,0 m	0,0	0,0 m
Circuit 3	31	150ct3f2	0,0	0,0 m	0,0	0,0 m
Circuit 3	32	150ct3f3	0,0	0,0 m	0,0	0,0 m
Circuit 4	40	150ct4f1	0,0	0,0 m	0,0	0,0 m
Circuit 4	41	150ct4f2	0,0	0,0 m	0,0	0,0 m
Circuit 4	42	150ct4f3	0,0	0,0 m	0,0	0,0 m
Bliksemdraad 1	1	bl1	0,0	0,0 m	0,0	0,0 m
Bliksemdraad 2	3	bl2	0,0	0,0 m	0,0	0,0 m

Lijn- en mastgegevens

	Back	Ahead
Ruling span $\sqrt{(\Sigma L^3/\Sigma L)}$	400,0	400,0 m
Lijnhoek	180 °	
Rotatie mast t.o.v. bissectrice	θ	0 °
Vaklengte	800	800 m
Hoogte onderkant mast t.o.v. maaiveld	0,5 m	
Beschouwde windrichtingen	α_1	0 °
Windrichtingen volgens:	α_2	45 °
<i>Geleiderbelastingen</i>	α_3	90 °
	α_4	135 °
	α_5	- °
	α_6	- °

Windrichtingen gelden t.o.v. hoofdrichting mastconstructie, niet t.o.v. bissectrice.

Windrichtingen en positieve richtingen belastingen

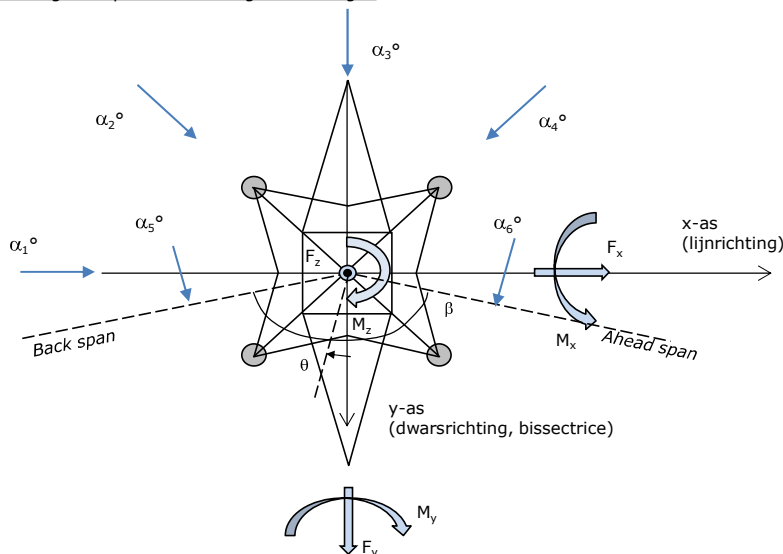

Beschouwd aantal windrichtingen	
1a	4
3	4
4	1
6	1
Overig	1

Project: RLL-TLB380
 Tower: S+6_c
 Number: 1101

Geleiderafval

		SPLS - torsie		SPLS - Enkelzijdige trek		5a - geleiderbreuk	
		Aanw.	Afw.	Aanw.	Afw.	Aanw.	Afw.
Circuit 1	380ct1f1	1	0	1	0	0,8	0
Circuit 1	380ct1f2	1	0	1	0	0,8	0
Circuit 1	380ct1f3	1	0	1	0	0,8	0
Circuit 2	380ct2f1	0	1	1	0	0,8	0
Circuit 2	380ct2f2	0	1	1	0	0,8	0
Circuit 2	380ct2f3	0	1	1	0	0,8	0
Circuit 3	150ct3f1	1	0	1	0	0,8	0
Circuit 3	150ct3f2	1	0	1	0	0,8	0
Circuit 3	150ct3f3	1	0	1	0	0,8	0
Circuit 4	150ct4f1	0	1	1	0	0,8	0
Circuit 4	150ct4f2	0	1	1	0	0,8	0
Circuit 4	150ct4f3	0	1	1	0	0,8	0
Bliksemdraad 1	b1	1	0	1	0	1	0
Bliksemdraad 2	b2	0	1	1	0	1	0

Belastingsituaties SPLS

Beschouwde situaties SPLS: SPLS voor steunmast niet van toepassing

Principe belastingssituaties:

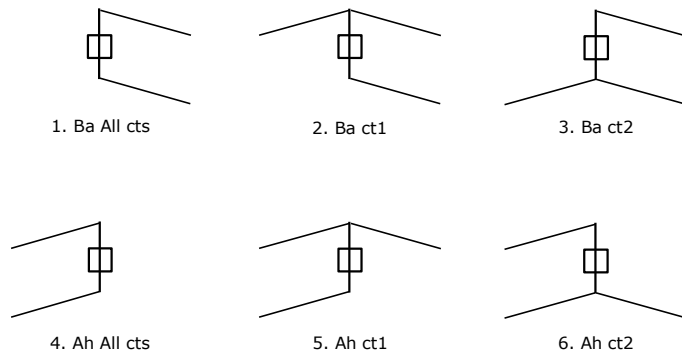

Belastingsituaties 5a. Geleiderbreuk

Beschouwde situaties geleiderbreuk 5a: 1 en 2, alle mogelijke situaties.

Principe belastingssituaties:

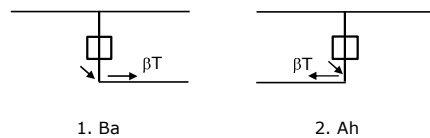

Project: RLL-TLB380
 Tower: S+6_c
 Number: 1101

Belastingsituaties 6. Bouw- en onderhoud

Onder 6a wordt de belasting door aanwezigheid lijnwagen of lijnfiets in combinatie met puntlast op traverse in rekening gebracht. Combinatie 6b bevat geen belastingen in geleider of op traverse. Deze combinatie is toegevoegd om te kunnen combineren met separate controle bordessen etc. De situaties worden in ULS en in iedere SPLS-situatie (in geval van hoekmast) toegepast.

	Fase	Bliksem
Lijnwagen	4,0 kN	2,0 kN
Puntlast op traverse	1,0 kN	1,0 kN

Beschouwde situaties bouw- en onderhoud 6a: 1 t/m 4, alle mogelijke situaties.

Aanwezigheid lijnwagen: Circuit, belasting tegelijk aanwezig in alle geleiders per circuit.

Principe belastingssituaties:

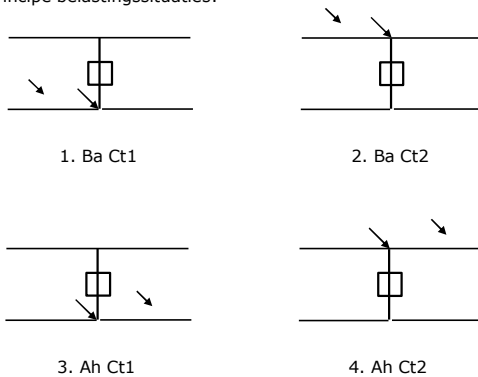

Belastingsituaties 8. Lijndansen als statische belasting

Geleider		
Steunmast fase	0,866 W	1,5 W
Steunmast bliksem	1,5 EDS	1,5 W
Hoekmast fase en bliksem	1,5 EDS	1,5 W

Considered situations galloping 8: 1 and 2, all possible situations

Belasting tegelijk aanwezig in alle geleiders van het circuit.

Principe belastingssituaties:

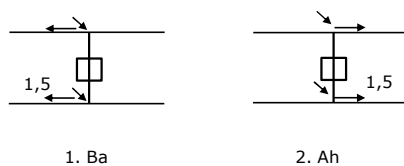

Belastingcombinatie 8. Lijndansen als dynamische belasting

Alleen van toepassing op hoek- en eindmasten

Belasting bestaat uit EDS-trekbelasting in één van de geleiders aan één zijde van de mast

Door gebruiker via het belastingsspectrum van tabel 4.11/NL.1 om te zetten naar spanningspectrum

Project: RLL-TLB380
 Tower: S+6_c
 Number: 1101

Mastconstructie

Eigenschappen

Masttype	Steunmast
Mastbenaming	S+6_c
Voetplaat t.o.v. maaiveld	0,5 m
Masthoogte t.o.v. voetplaat	62,7 m
Gewicht mast	482,0 kN

<i>Breedte en helling mast bij fundatie</i>	x-ri.	y-ri.
Pootsprei	11,14	11,14 m
Helling van de randstijl	0,150	0,150 -
Factor spatkracht	1,1	1,1 -

Berekening windbelasting

Dynamische invloed G_T	1,00 (<i>Masthoogte < 60 m</i>)
Windbelasting overhoeks op mastlichaam evenredig met:	$(A1C1\sin^2(\phi)+A2C2\cos^2(\phi))$
Windbelasting overhoeks op traverse evenredig met:	$(A1C1\sin^2(\phi)+A2C2\cos^2(\phi))$
Vergroting wind overhoeks mastlichaam	$(1+0,2\sin^2(2\phi))$
Vergroting wind overhoeks traverse	$(1+0,2\sin^2(2\phi))$
Factor wind evenwijdig t.o.v. haaks op traverse	0,4

Eigenschappen mastsecties langsrichting (vooraanzicht, yz-vlak)

Omschrijving	h [m]	b_1 [m]	b_2 [m]	Δh [m]	Δ_x [m]	A_0 [m ²]	A_1 [m ²]	$\chi = A_1/A_0$ [-]	C_t
Broekstuk	17,40	11,14	5,92	17,40	0,150	148,46	21,82	0,15	3,17
Eerste tussenstuk	30,10	5,92	4,55	12,70	0,054	66,50	14,15	0,21	2,88
Tweede tussenstuk	38,90	4,55	3,60	8,80	0,054	35,86	10,13	0,28	2,60
Bovenstuk 1	48,40	3,60	2,92	9,50	0,036	30,97	9,99	0,32	2,46
Bovenstuk 2	61,00	2,92	2,01	12,60	0,036	31,06	9,61	0,31	2,50
Topstuk	62,70	2,01		1,70		1,71	0,32	0,18	3,00
Ondertraverse	38,90	12,70		3,00		19,05	4,75	0,25	2,72
Middentraverse	48,40	16,34		3,00		24,51	6,81	0,28	2,62
Boventraverse	58,40	13,70	1,00	2,60		24,66	6,19	0,25	2,72

Eigenschappen mastsecties dwarsrichting (zijaanzicht, xz-vlak)

Omschrijving	h [m]	b_1 [m]	b_2 [m]	Δh [m]	Δ_x [m]	A_0 [m ²]	A_1 [m ²]	$\chi = A_1/A_0$ [-]	C_t
Broekstuk	17,40	11,14	5,92	17,40	0,150	148,46	21,82	0,15	3,17
Eerste tussenstuk	30,10	5,92	4,55	12,70	0,054	66,50	14,15	0,21	2,88
Tweede tussenstuk	38,90	4,55	3,60	8,80	0,054	35,86	10,13	0,28	2,60
Bovenstuk 1	48,40	3,60	2,92	9,50	0,036	30,97	9,99	0,32	2,46
Bovenstuk 2	61,00	2,92	2,01	12,60	0,036	31,06	9,61	0,31	2,50
Topstuk	62,70	2,01		1,70		1,71	0,32	0,18	3,00
Ondertraverse	38,90	12,70		3,00		19,05	4,75	0,25	2,72
Middentraverse	48,40	16,34		3,00		24,51	6,81	0,28	2,62
Boventraverse	58,40	13,70	1,00	2,60		24,66	6,19	0,25	2,72

NB: oppervlakte traverse dwarsrichting wordt in berekening gereduceerd.

Project: RLL-TLB380
 Tower: S+6_c
 Number: 1101

Windoppervlak feeders telecominstallaties

Onderdeel	A (m ² /m)	Factor	Δh	A ₁
Broekstuk	0,14	0,71	17,4	1,7
Eerste tussenstuk	0,14	0,71	12,7	1,3
Tweede tussenstuk	0,14	0,71	8,8	0,9
Bovenstuk 1	0,14	0,71	9,5	0,9
Bovenstuk 2				

Invoer antennes

Omschrijving	A (m ²)	h (m)	C _r (m)
Antenne top			
Antenne o.t.	4,7	45,2	1,5

Belastingen mastsectie langsrichting (x-richting) per windrichting

Omschrijving	P _w [kN/m ²]	F _{x1} [kN]	F _{x2} [kN]	F _{x3} [kN]	F _{x4} [kN]	h _{ef} [m]	M _{y1} [kNm]	M _{y2} [kNm]	M _{y3} [kNm]	M _{y4} [kNm]
Broekstuk	0,70	48,5	41,2	0,0	-41,2	8,7	422,2	358,3	0,0	-358,3
Eerste tussenstuk	0,92	37,6	31,9	0,0	-31,9	23,8	892,8	757,5	0,0	-757,5
Tweede tussenstuk	1,03	27,0	23,0	0,0	-23,0	34,5	933,1	791,8	0,0	-791,8
Bovenstuk 1	1,10	27,0	22,9	0,0	-22,9	43,7	1176,8	998,5	0,0	-998,5
Bovenstuk 2	1,16	27,9	23,7	0,0	-23,7	54,7	1528,7	1297,1	0,0	-1297,1
Topstuk	1,20	1,1	1,0	0,0	-1,0	61,9	70,2	59,6	0,0	-59,6
Ondertraverse	1,07	27,7	16,5	0,0	-16,5	39,9	1105,1	656,4	0,0	-656,4
Middentraverse	1,13	40,3	24,0	0,0	-24,0	49,4	1992,2	1183,3	0,0	-1183,3
Boventraverse	1,19	39,9	23,7	0,0	-23,7	59,3	2366,4	1405,6	0,0	-1405,6
Totaal		277,2	207,7	0,0	-207,7		10487,6	7508,2	0,0	-7508,2

Belastingen mastsectie dwarsrichting (y-richting) per windrichting

Omschrijving	P _w [kN/m ²]	F _{y1} [kN]	F _{y2} [kN]	F _{y3} [kN]	F _{y4} [kN]	h _{ef} [m]	M _{x1} [kNm]	M _{x2} [kNm]	M _{x3} [kNm]	M _{x4} [kNm]
Broekstuk	0,70	0,0	41,2	48,5	41,2	8,7	0,0	358,3	422,2	358,3
Eerste tussenstuk	0,92	0,0	31,9	37,6	31,9	23,8	0,0	757,5	892,8	757,5
Tweede tussenstuk	1,03	0,0	23,0	27,0	23,0	34,5	0,0	791,8	933,1	791,8
Bovenstuk 1	1,10	0,0	22,9	27,0	22,9	43,7	0,0	998,5	1176,8	998,5
Bovenstuk 2	1,16	0,0	23,7	27,9	23,7	54,7	0,0	1297,1	1528,7	1297,1
Topstuk	1,20	0,0	1,0	1,1	1,0	61,9	0,0	59,6	70,2	59,6
Ondertraverse	1,07	0,0	16,5	11,1	16,5	39,9	0,0	656,4	442,0	656,4
Middentraverse	1,13	0,0	24,0	16,1	24,0	49,4	0,0	1183,3	796,9	1183,3
Boventraverse	1,19	0,0	23,7	16,0	23,7	59,3	0,0	1405,6	946,6	1405,6
Totaal		0,0	207,7	212,4	207,7		0,0	7508,2	7209,3	7508,2

Resulterende belastingen vanuit mastconstructie incl. antenne zonder geleiders niveau fundatie (kar. waarde)

Belasting / windrichting	F _x [kN]	F _y [kN]	F _z [kN]	M _x [kNm]	M _y [kNm]	M _z [kNm]
Permanente belasting	0	0	482	0	0	0
Windrichting 0°	285	0	0	0	10840	0
Windrichting 45°	213	213	0	7757	7757	0
Windrichting 90°	0	220	0	7562	0	0
Windrichting 135°	-213	213	0	7757	-7757	0

Project: RLL-TLB380
 Tower: S+6_c
 Number: 1101

Tussenresultaten geleiderbelastingen

Geleiders back

Circuit	Geleider	Diameter [mm]	A [mm ²]	G [N/m]	E [N/mm ²]	αT [-]
Circuit 1	AAAC-AL7 620	32,4	621,0	17,71	56000	2,30E-05
Circuit 2	AAAC-AL7 620	32,4	621,0	17,71	56000	2,30E-05
Circuit 3	AAAC-AL7 620	32,4	621,0	17,71	56000	2,30E-05
Circuit 4	AAAC-AL7 620	32,4	621,0	17,71	56000	2,30E-05
Bliksemdraad 1	AACSR 241-AL3-39-A20SA	21,8	281,0	9,38	70165	1,97E-05
Bliksemdraad 2	OPGW AFL-226/38	21,7	264,0	9,13	72000	1,98E-05

Geleiders ahead

Circuit	Geleider	Diameter [mm]	A [mm ²]	G [N/m]	E [N/mm ²]	αT [-]
Circuit 1	AAAC-AL7 620	32,4	621,0	17,71	56000	2,30E-05
Circuit 2	AAAC-AL7 620	32,4	621,0	17,71	56000	2,30E-05
Circuit 3	AAAC-AL7 620	32,4	621,0	17,71	56000	2,30E-05
Circuit 4	AAAC-AL7 620	32,4	621,0	17,71	56000	2,30E-05
Bliksemdraad 1	AACSR 241-AL3-39-A20SA	21,8	281,0	9,38	70165	1,97E-05
Bliksemdraad 2	OPGW AFL-226/38	21,7	264,0	9,13	72000	1,98E-05

Verticale belasting back

Circuit	Bundel [-]	Toeslag [%]	$w_{z,G}$ [N/m]	IJsg gebied	Formule	$w_{z,ijs}$ [N/m]	$w_{z,ijs,bundel}$ [N/m]
Circuit 1	4	3	73,0		B 4+0,2d	10,5	41,9
Circuit 2	4	3	73,0		B 4+0,2d	10,5	41,9
Circuit 3	2	3	36,5		B 4+0,2d	10,5	21,0
Circuit 4	2	3	36,5		B 4+0,2d	10,5	21,0
Bliksemdraad 1	1	2	9,6		A 15+0,4d	23,7	23,7
Bliksemdraad 2	1	2	9,3		A 15+0,4d	23,7	23,7

Verticale belasting ahead

Circuit	Bundel [-]	Toeslag [%]	$w_{z,G}$ [N/m]	IJsg gebied	Formule	$w_{z,ijs}$ [N/m]	$w_{z,ijs,bundel}$ [N/m]
Circuit 1	4	3	73,0		B 4+0,2d	10,5	41,9
Circuit 2	4	3	73,0		B 4+0,2d	10,5	41,9
Circuit 3	2	3	36,5		B 4+0,2d	10,5	21,0
Circuit 4	2	3	36,5		B 4+0,2d	10,5	21,0
Bliksemdraad 1	1	2	9,6		A 15+0,4d	23,7	23,7
Bliksemdraad 2	1	2	9,3		A 15+0,4d	23,7	23,7

Isolatoren

Geleider	$G_{isolator}$ [kN]	Aantal	$F_{V,iso}$ [kN]	Lengte [m]	Windopp. [m ²]	Windhoogte [m]	Stuwdruk [kN/m ²]	Vormfactor	$F_{th,iso}$ [kN]
380ct1f1	4,50	1	4,5	4,5	2,0	37,15	1,05	1,2	2,52
380ct1f2	4,50	1	4,5	4,5	2,0	46,65	1,12	1,2	2,68
380ct1f3	4,50	1	4,5	4,5	2,0	56,65	1,17	1,2	2,81
380ct2f1	4,50	1	4,5	4,5	2,0	37,15	1,05	1,2	2,52
380ct2f2	4,50	1	4,5	4,5	2,0	46,65	1,12	1,2	2,68
380ct2f3	4,50	1	4,5	4,5	2,0	56,65	1,17	1,2	2,81
150ct3f1	2,50	1	2,5	4,0	1,0	37,40	1,05	1,2	1,26
150ct3f2	2,50	1	2,5	4,0	1,0	46,90	1,12	1,2	1,34
150ct3f3	2,50	1	2,5	4,0	1,0	56,90	1,17	1,2	1,41
150ct4f1	2,50	1	2,5	4,0	1,0	37,40	1,05	1,2	1,26
150ct4f2	2,50	1	2,5	4,0	1,0	46,90	1,12	1,2	1,34
150ct4f3	2,50	1	2,5	4,0	1,0	56,90	1,17	1,2	1,41
bl1	0,10	1	0,1	0,2	0,1	60,30	1,19	1,2	0,14
bl2	0,10	1	0,1	0,2	0,1	60,30	1,19	1,2	0,14

Project: RLL-TLB380
 Tower: S+6_c
 Number: 1101

Windbelasting back

Geleider	hoogte		G _{c_dwars}	G _{c_trek}	C _c	d _{toeslag}	W _y	W _{y,vak}	D _{ijs,toeslag}	W _{y,ijs}	W _{y,ijs,vak}
	wind	Stuwdruk									
	[m]	[kN/m ²]	[-]	[-]	[-]	[mm]	[N/m]	[N/m]	[mm]	[N/m]	[N/m]
380ct1f1	30,5	0,99	0,58	0,58	1,00	33,37	77,0	77,0	51,8	143,0	143,0
380ct1f2	40,0	1,07	0,60	0,60	0,98	33,37	84,0	84,0	51,8	159,7	159,7
380ct1f3	50,0	1,14	0,62	0,62	0,96	33,37	89,8	89,8	51,8	174,4	174,4
380ct2f1	30,5	0,99	0,58	0,58	1,00	33,37	77,0	77,0	51,8	143,0	143,0
380ct2f2	40,0	1,07	0,60	0,60	0,98	33,37	84,0	84,0	51,8	159,7	159,7
380ct2f3	50,0	1,14	0,62	0,62	0,96	33,37	89,8	89,8	51,8	174,4	174,4
150ct3f1	31,0	1,00	0,58	0,58	1,00	33,37	38,7	38,7	51,8	72,0	72,0
150ct3f2	40,5	1,07	0,60	0,60	0,98	33,37	42,1	42,1	51,8	80,3	80,3
150ct3f3	50,5	1,14	0,62	0,62	0,96	33,37	45,0	45,0	51,8	87,5	87,5
150ct4f1	31,0	1,00	0,58	0,58	1,00	33,37	38,7	38,7	51,8	72,0	72,0
150ct4f2	40,5	1,07	0,60	0,60	0,98	33,37	42,1	42,1	51,8	80,3	80,3
150ct4f3	50,5	1,14	0,62	0,62	0,96	33,37	45,0	45,0	51,8	87,5	87,5
bl1	55,8	1,17	0,63	0,63	1,18	22,24	19,2	19,2	63,1	55,4	55,4
bl2	55,8	1,17	0,63	0,63	1,18	22,13	19,1	19,1	63,0	55,3	55,3

Windbelasting ahead

Geleider	hoogte		G _{c_dwars}	G _{c_trek}	C _c	d _{toeslag}	W _y	W _{y,vak}	D _{ijs,toeslag}	W _{y,ijs}	W _{y,ijs,vak}
	wind	Stuwdruk									
	[m]	[kN/m ²]	[-]	[-]	[-]	[mm]	[N/m]	[N/m]	[mm]	[N/m]	[N/m]
380ct1f1	30,5	0,99	0,58	0,58	1,00	33,37	77,0	77,0	51,8	143,0	143,0
380ct1f2	40,0	1,07	0,60	0,60	0,98	33,37	84,0	84,0	51,8	159,7	159,7
380ct1f3	50,0	1,14	0,62	0,62	0,96	33,37	89,8	89,8	51,8	174,4	174,4
380ct2f1	30,5	0,99	0,58	0,58	1,00	33,37	77,0	77,0	51,8	143,0	143,0
380ct2f2	40,0	1,07	0,60	0,60	0,98	33,37	84,0	84,0	51,8	159,7	159,7
380ct2f3	50,0	1,14	0,62	0,62	0,96	33,37	89,8	89,8	51,8	174,4	174,4
150ct3f1	31,0	1,00	0,58	0,58	1,00	33,37	38,7	38,7	51,8	72,0	72,0
150ct3f2	40,5	1,07	0,60	0,60	0,98	33,37	42,1	42,1	51,8	80,3	80,3
150ct3f3	50,5	1,14	0,62	0,62	0,96	33,37	45,0	45,0	51,8	87,5	87,5
150ct4f1	31,0	1,00	0,58	0,58	1,00	33,37	38,7	38,7	51,8	72,0	72,0
150ct4f2	40,5	1,07	0,60	0,60	0,98	33,37	42,1	42,1	51,8	80,3	80,3
150ct4f3	50,5	1,14	0,62	0,62	0,96	33,37	45,0	45,0	51,8	87,5	87,5
bl1	55,8	1,17	0,63	0,63	1,18	22,24	19,2	19,2	63,1	55,4	55,4
bl2	55,8	1,17	0,63	0,63	1,18	22,13	19,1	19,1	63,0	55,3	55,3

Project: RLL-TLB380
 Masttype: S+6_c
 Mast: 1101

Auteur: TBR
 Versie: v11.8

Geleiderbelastingen

Uitgangspunten

Betrouwbaarheidsniveau Nieuwbouw CC2
 Referentieperiode 50 jaar

ULS (bezwijksterkte)		NEN-EN50341-2-15:2019						
Belastingsgeval	omschrijving	Temp °C	γ_G		γ_Q			γ_a A_k
			$G_{k,mast}$	$G_{k,geleider}$	Q_{pk}	Q_{wk}	Q_{ik}	
ULS 1a	Wind	10°	1,20	1,20	0,00	1,50	0,00	0,0
ULS 1a_0,9	Wind 0,9Gk alleen mast	10°	0,90	1,20	0,00	1,50	0,00	0,0
ULS 1a_0,9_0,9	Wind 0,9Gk ook geleider	10°	0,90	0,90	0,00	1,50	0,00	0,0
ULS 3	Wind+ijs	-5°	1,20	1,20	0,00	0,45	1,50	0,0
ULS 3_0,9	Wind+ijs 0,9	-5°	0,90	1,20	0,00	0,45	1,50	0,0
ULS 4	Koude+wind	-20°	1,20	1,20	0,00	0,30	0,00	0,0
ULS 4_0,9	Koude+wind 0,9	-20°	0,90	1,20	0,00	0,30	0,00	0,0
ULS 5a	Torsiebelastingen	10°	1,00	1,00	1,00	0,00	0,00	1,0
ULS 5b	Longitudinale belastingen	10°	1,00	1,00	0,00	0,00	0,00	1,0
ULS 6	Bouw en onderhoud	5°	1,20	1,20	1,50	0,30	0,00	0,0
ULS 6_0,9	Bouw en onderhoud	5°	1,20	1,20	0,00	0,30	0,00	0,0
ULS 7	Permanent	10°	1,35	1,35	0,00	0,00	0,00	0,0
ULS 8	Special	10°	1,00	1,00	0,00	0,00	0,00	1,0
SPLS (Bezwijksterkte, enkel voor hoekmasten: afwezigheid geleiders)			γ_G		γ_Q			
			G_k		Q_{pk}	Q_{wk}	Q_{ik}	A_k
SPLS 1a	Wind	10°	1,20	1,20	0,0	0,78	0,00	0,0
SPLS 1a_0,9	Wind 0,9	10°	0,90	1,20	0,0	0,78	0,00	0,0
SPLS 1a_0,9_0,9	Wind 0,9	10°	0,90	0,90	0,0	0,78	0,00	0,0
SPLS 3	Wind+ijs	-5°	1,20	1,20	0,0	0,36	0,34	0,0
SPLS 3_0,9	Wind+ijs 0,9	-5°	0,90	1,20	0,0	0,36	0,34	0,0
SPLS 4	Koude+wind	-20°	1,20	1,20	0,0	0,24	0,00	0,0
SPLS 4_0,9	Koude+wind 0,9	-20°	0,90	1,20	0,0	0,24	0,00	0,0
SPLS 6	Bouw en onderhoud	5°	1,20	1,20	1,2	0,24	0,0	0,0
SPLS 6_0,9	Bouw en onderhoud	5°	1,20	1,20	0,0	0,24	0,0	0,0
SLS (controle van de vervormingen, vermoeiing, EDS)			G_k		Q_{pk}	Q_{wk}	Q_{ik}	A_k
SLS 1a	Wind	10°	1,00	1,00	0,0	1,00	0,0	0,0
SLS 3	Wind+ijs	-5°	1,00	1,00	0,0	0,30	1,00	0,0
SLS 4	Wind	-20°	1,00	1,00	0,0	0,20	0,0	0,0
SLS 6	Bouw en onderhoud	5°	1,00	1,00	0,0	0,20	0,0	0,0
SLS 7	PB (EDS, geen wind)	10°	1,00	1,00	0,0	0,00	0,0	0,0

Aantal windrichtingen 4
 Aantal belastingcombinaties ULS 62
 Aantal belastingcombinaties SPLS 0
 Aantal belastingcombinaties SLS 11
 Aantal knooplasten 1022

Project: RLL-TLB380
 Masttype: S+6_c
 Mast: 1101

Samenvattingstabellen geleiderbelastingen

In de onderstaande vier tabellen is weergegeven:

- De maximale geleiderbelasting in het globale assenstelsel, gesplitst in aandeel van back en ahead span
- De gecombineerde geleiderbelasting (Ba+Ah) in het globale assenstelsel met in het lokale assenstelsel de maximaal optredende trekkracht. Componenten Fx en Fy als absolute waarde
- De alledaagse (EDS) waarden van de gecombineerde geleiderbelastingen (Ba+Ah) met bijbehorende trekkrachten
- Controle op uplift, waar een negatieve waarde duidt op uplift

Maximale waarden voor back en ahead span

Geleider	Fx_ba [kN]	Fx_ah [kN]	Fy_ba [kN]	Fy_ah [kN]	Fz_ba [kN]	Fz_ah [kN]
bl1	-66,6	66,6	5,9	5,9	10,5	10,5
380ct1f1	-260,1	260,1	25,0	25,0	36,7	36,7
380ct1f2	-263,7	263,7	27,2	27,2	36,7	36,7
380ct1f3	-267,2	267,2	29,0	29,0	36,8	36,8
380ct2f1	-260,1	260,1	25,0	25,0	36,7	36,7
380ct2f2	-263,7	263,7	27,2	27,2	36,7	36,7
380ct2f3	-267,2	267,2	29,0	29,0	36,8	36,8
150ct3f1	-130,1	130,1	12,6	12,6	18,8	18,8
150ct3f2	-132,0	132,0	13,6	13,6	18,8	18,8
150ct3f3	-133,7	133,7	14,6	14,6	18,8	18,8
150ct4f1	-130,1	130,1	12,6	12,6	18,8	18,8
150ct4f2	-132,0	132,0	13,6	13,6	18,8	18,8
150ct4f3	-133,7	133,7	14,6	14,6	18,8	18,8
bl2	-65,6	65,6	5,8	5,8	10,4	10,4

Min. Weight span (m)

Weight spar Combinatie1

Geleider	SLS 1a	SLS 4	SLS 7
bl1	454,0	465,1	454,0
380ct1f1	454,0	463,8	454,0
380ct1f2	454,0	464,0	454,0
380ct1f3	454,0	464,2	454,0
380ct2f1	454,0	463,8	454,0
380ct2f2	454,0	464,0	454,0
380ct2f3	454,0	464,2	454,0
150ct3f1	454,0	463,8	454,0
150ct3f2	454,0	464,0	454,0
150ct3f3	454,0	464,2	454,0
150ct4f1	454,0	463,8	454,0
150ct4f2	454,0	464,0	454,0
150ct4f3	454,0	464,2	454,0
bl2	454,0	465,2	454,0

Max. Weight span (m)

Weight spar Combinatie1

Geleider	ULS 1a	ULS 3
bl1	513,5	442,4
380ct1f1	477,5	451,9
380ct1f2	480,9	452,6
380ct1f3	483,8	453,3
380ct2f1	477,5	451,9
380ct2f2	480,9	452,6
380ct2f3	483,8	453,3
150ct3f1	477,7	451,9
150ct3f2	481,1	452,6
150ct3f3	484,0	453,3
150ct4f1	477,7	451,9
150ct4f2	481,1	452,6
150ct4f3	484,0	453,3
bl2	515,1	442,2

Omhullende weight span over alle combinaties (incl. 0,9 combinaties)

Voor alle geleiders

Max. weight span	515,1 m
Min. weight span	249,9 m

Wind / Weight span verhouding

	1,288 -
	0,625 -

Project: RLL-TLB380
 Masttype: S+6_c
 Mast: 1101

Maximale waarden back+ahead span Maximale waarden trekkracht geleider

Geleider	Maximale waarden back+ahead span			Maximale waarden trekkracht geleider	
	Fx [kN]	Fy [kN]	Fz [kN]	Ft_ba [kN]	Ft_ah [kN]
bl1	25,8	11,7	20,9	-66,6	66,6
380ct1f1	105,1	50,0	73,4	-260,1	260,1
380ct1f2	105,1	54,4	73,5	-263,7	263,7
380ct1f3	105,1	58,1	73,6	-267,2	267,2
380ct2f1	105,1	50,0	73,4	-260,1	260,1
380ct2f2	105,1	54,4	73,5	-263,7	263,7
380ct2f3	105,1	58,1	73,6	-267,2	267,2
150ct3f1	52,5	25,1	37,0	-130,1	130,1
150ct3f2	52,5	27,3	37,0	-132,0	132,0
150ct3f3	52,5	29,1	37,1	-133,7	133,7
150ct4f1	52,5	25,1	37,0	-130,1	130,1
150ct4f2	52,5	27,3	37,0	-132,0	132,0
150ct4f3	52,5	29,1	37,1	-133,7	133,7
bl2	25,1	11,7	20,8	-65,6	65,6

EDS-belastingen geleiders

Geleider	EDS-belastingen geleiders				
	Fx [kN]	Fy [kN]	Fz [kN]	Ft_ba [kN]	Ft_ah [kN]
bl1	0,0	0,0	4,4	-17,2	17,2
380ct1f1	0,0	0,0	37,6	-131,3	131,3
380ct1f2	0,0	0,0	37,6	-131,3	131,3
380ct1f3	0,0	0,0	37,6	-131,3	131,3
380ct2f1	0,0	0,0	37,6	-131,3	131,3
380ct2f2	0,0	0,0	37,6	-131,3	131,3
380ct2f3	0,0	0,0	37,6	-131,3	131,3
150ct3f1	0,0	0,0	19,1	-65,7	65,7
150ct3f2	0,0	0,0	19,1	-65,7	65,7
150ct3f3	0,0	0,0	19,1	-65,7	65,7
150ct4f1	0,0	0,0	19,1	-65,7	65,7
150ct4f2	0,0	0,0	19,1	-65,7	65,7
150ct4f3	0,0	0,0	19,1	-65,7	65,7
bl2	0,0	0,0	4,3	-16,8	16,8

Controle uplift SLS-wind

Combinatie: Geleider	Controle uplift SLS-wind	
	Fz_ba [kN]	Fz_ah [kN]
SLS 4		
bl1	2,3	2,3
380ct1f1	19,2	19,2
380ct1f2	19,2	19,2
380ct1f3	19,2	19,2
380ct2f1	19,2	19,2
380ct2f2	19,2	19,2
380ct2f3	19,2	19,2
150ct3f1	9,7	9,7
150ct3f2	9,7	9,7
150ct3f3	9,7	9,7
150ct4f1	9,7	9,7
150ct4f2	9,7	9,7
150ct4f3	9,7	9,7
bl2	2,2	2,2

Project: RLL-TLB380
 Masttype: S+6_c
 Mast: 1101

ULS-fundatiebelasting combinatie 1 en 3 wind haaks op de lijn of bissectrice en EDS, vanuit geleiders

Combinatie	Combination	F_x [kN]	F_y [kN]	F_z [kN]	M_x [kNm]	M_y [kNm]	M_z [kNm]
ULS 1a_90		0	511	441	25339	0	0
ULS 1a_0,9_90		0	511	309	25339	0	0
ULS 3_90		0	289	705	14431	0	0
ULS 3_0,9_90		0	289	555	14430	0	0
SLS 7		0	0	349	2	0	0

ULS-fundatiebelasting combinatie 1 en 3 wind haaks op de lijn of bissectrice en EDS, totaal geleiders en mast

Combinatie	F_x [kN]	F_y [kN]	F_z [kN]	M_x [kNm]	M_y [kNm]	M_z [kNm]
ULS 1a_90	0	842	1020	36682	0	0
ULS 3_90	0	388	1283	17833	0	0
SLS 7	0	0	831	2	0	0

Fundatiebelastingen, selectie belastingcombinaties op basis grootste waarde

Combinatie	F_x [kN]	F_y [kN]	F_z [kN]	M_x [kNm]	M_y [kNm]	M_z [kNm]
ULS 1a_90	0	842	1020	36682	0	0
ULS 1a_0	446	0	996	2	17168	0
ULS 5a Ba 11	105	0	828	-230	5085	1471
ULS 1a_45	333	583	1004	24677	12278	0

Noot: grootste waarden kunnen in meerdere combinaties voorkomen, een combinatie is weergegeven.

Oplegreacties op fundering per randstijl

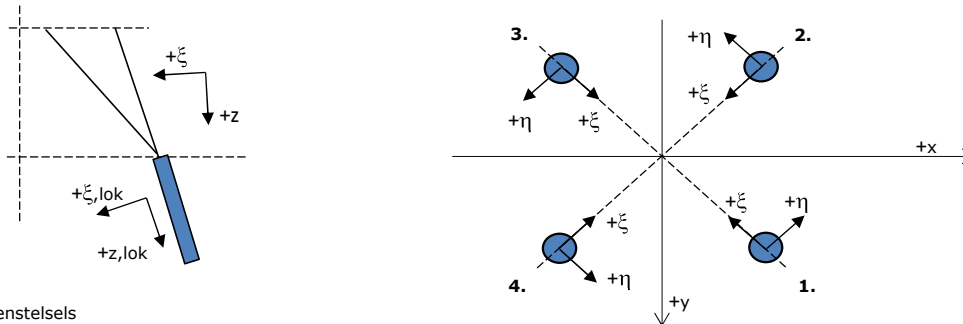

Assenstelsels

Maximale drukbelasting

Stijl	Combinatie	R_x [kN]	R_y [kN]	R_z [kN]	R_η [kN]	R_ξ [kN]	$R_{\xi,lok}$ [kN]	$R_{z,lok}$ [kN]
1	ULS 1a_45	307	278	1909	21	-414	-9	1952
2	ULS 1a_0	153	-168	1019	11	-227	-11	1042
3	ULS 8 Ba	-118	-156	946	-27	-194	7	967
4	ULS 1a_135	-307	278	1909	-21	-414	-9	1952

Maximale trekbelasting

Stijl	Combinatie	R_x [kN]	R_y [kN]	R_z [kN]	R_η [kN]	R_ξ [kN]	$R_{\xi,lok}$ [kN]	$R_{z,lok}$ [kN]
1	ULS 8 Ba	-37	-75	-453	27	79	-17	-464
2	ULS 1a_0,9_0,9_135	-238	209	-1491	21	316	0	-1524
3	ULS 1a_0,9_0,9_45	238	209	-1491	-21	316	0	-1524
4	ULS 1a_0,9_0,9_0	83	-99	-600	-11	129	2	-613

Maximale torsiebelasting (positief)

Stijl	Combinatie	R_x [kN]	R_y [kN]	R_z [kN]	R_η [kN]	R_ξ [kN]	$R_{\xi,lok}$ [kN]	$R_{z,lok}$ [kN]
1	ULS 5a Ah 21	43	-36	-11	56	-4	-7	-11
2	ULS 5a Ba 11	29	-105	446	54	-95	0	456
3	ULS 5a Ba 11	-43	36	-11	56	-4	-7	-11
4	ULS 5a Ah 21	-29	105	446	54	-95	0	456

Maximale torsiebelasting (negatief)

Stijl	Combinatie	R_x [kN]	R_y [kN]	R_z [kN]	R_η [kN]	R_ξ [kN]	$R_{\xi,lok}$ [kN]	$R_{z,lok}$ [kN]
1	ULS 5a Ba 21	29	105	446	-54	-95	0	456
2	ULS 5a Ah 11	43	36	-11	-56	-4	-7	-11
3	ULS 5a Ah 11	-29	-105	446	-54	-95	0	456
4	ULS 5a Ba 21	-43	-36	-11	-56	-4	-7	-11

Project: RLL-TLB380
 Masttype: S+6_c
 Mast: 1101

Combinatie Ftrek+Fhor

Stijl	Combinatie	R _x [kN]	R _y [kN]	R _z [kN]	R _η [kN]	R _ξ [kN]	R _{ξ,lok} [kN]	R _{z,lok} [kN]
1	ULS 8 Ba	-37	-75	-453	27	79	-17	-464
2	ULS 1a_0,9_0,9_90	-245	184	-1483	43	303	-12	-1516
3	ULS 1a_0,9_0,9_90	245	184	-1483	-43	303	-12	-1516
4	ULS 1a_0,9_0,9_0	83	-99	-600	-11	129	2	-613

Permanente belasting

Stijl	Combinatie	R _x [kN]	R _y [kN]	R _z [kN]	R _η [kN]	R _ξ [kN]	R _{ξ,lok} [kN]	R _{z,lok} [kN]
1	SLS 7	34	34	208	0	-48	-4	212
2	SLS 7	34	-34	208	0	-48	-4	212
3	SLS 7	-34	-34	208	0	-48	-4	212
4	SLS 7	-34	34	208	0	-48	-4	212

Omhullenden ongeacht stijl

Belasting	Combinatie	R _x [kN]	R _y [kN]	R _z [kN]	R _η [kN]	R _ξ [kN]	R _{ξ,lok} [kN]	R _{z,lok} [kN]
Max. druk	ULS 1a_45	307	278	1909	21	-414	-9	1952
Max. trek	ULS 1a_0,9_0,9_45	238	209	-1491	-21	316	0	-1524
Max. pos. torsie	ULS 5a Ah 21	43	-36	-11	56	-4	-7	-11
Max. neg. torsie	ULS 5a Ba 21	-43	-36	-11	-56	-4	-7	-11
Comb. trek+torsie	ULS 1a_0,9_0,9_90	-245	184	-1483	43	303	-12	-1516

Maximale trekbelasting SLS

Stijl	Combinatie	R _x [kN]	R _y [kN]	R _z [kN]	R _η [kN]	R _ξ [kN]	R _{ξ,lok} [kN]	R _{z,lok} [kN]
1	SLS 7	34	34	208	0	-48	-4	212
2	SLS 1a_135	-143	123	-897	14	188	-2	-917
3	SLS 1a_45	143	123	-897	-14	188	-2	-917
4	SLS 1a_0	40	-50	-306	-7	64	-1	-313

Maximale drukbelasting SLS

Stijl	Combinatie	R _x [kN]	R _y [kN]	R _z [kN]	R _η [kN]	R _ξ [kN]	R _{ξ,lok} [kN]	R _{z,lok} [kN]
1	SLS 1a_45	212	192	1314	14	-286	-7	1344
2	SLS 1a_0	109	-119	721	7	-161	-8	737
3	SLS 7	-34	-34	208	0	-48	-4	212
4	SLS 1a_135	-212	192	1314	-14	-286	-7	1344

Project: RLL-TLB380
Masttype: S+6_c
Mast: 1101

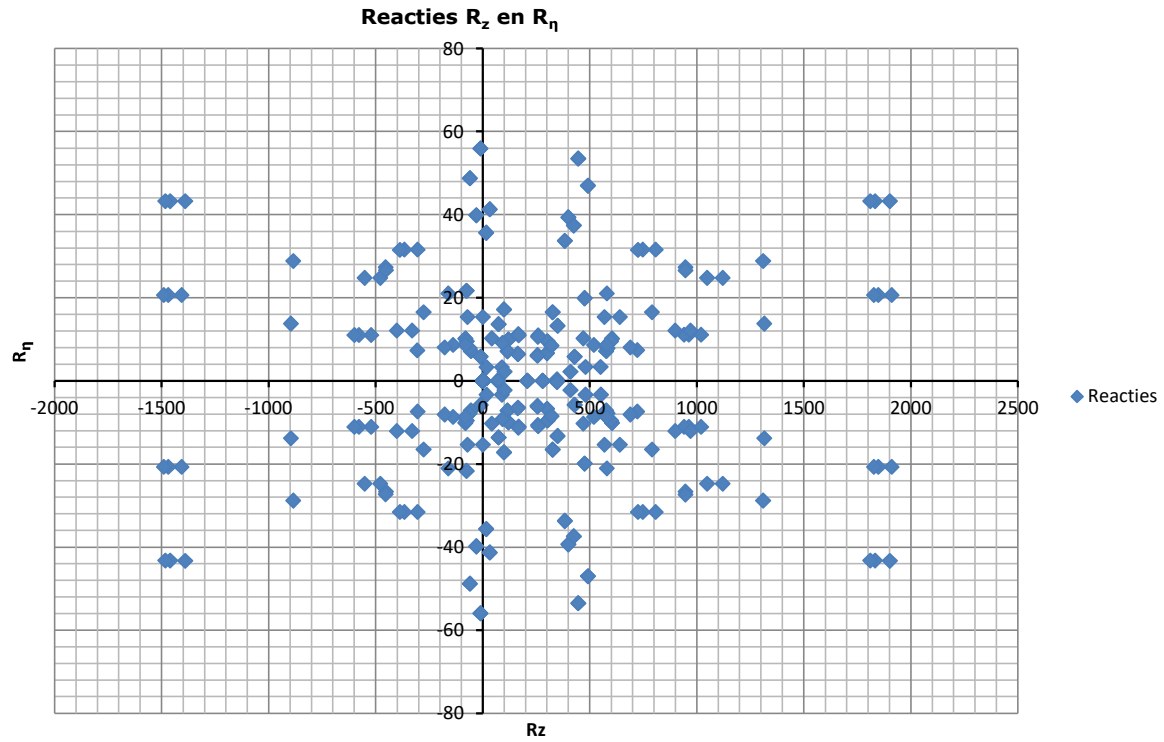

Project: RLL-TLB380
 Tower: S+9_c
 Number: 1073

Auteur: TBR
 Versie: v11.8

Geleiderbelastingen

Algemeen

Benaming S+9_c
 Masttype Steunmast
 Aantal circuits 4
 Configuratie 4-circuit-dubbel verticaal
 Aantal bliksemgeleiders 2

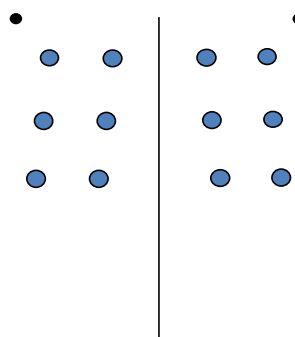

Configuratie geleiders

Uitgangspunten

Norm NEN-EN50341-2-15:2019
 Gevolgklasse initieel CC2
 Betrouwbaarheidsniveau initieel Nieuwbouw
 Referentieperiode initieel 50 jaar
 Referentieperiode na aanpassing CC2
 Betrouwbaarheidsniveau na aanpassing n.v.t.
 Referentieperiode na aanpassing 50 jaar
 Windgebied III
 Windsnelheid (m/s) 24,5 m/s
 Terreincategorie II
 Reductiefactor c_{dir} 1,00
 IJsg gebied fasegeleider B
 IJsg gebied bliksemgeleider A

Geleiders Back

Omschrijving	Spanning	Geleider Back	Bundel Ba	IJsg gebied	Toeslag gewicht	Toeslag diameter	Intrekwaarden P_{back}
Circuit 1	380 kV	AAAC-AL7 620	4	B	3 %	3 %	1800
Circuit 2	380 kV	AAAC-AL7 620	4	B	3 %	3 %	1800
Circuit 3	150 kV	AAAC-AL7 620	2	B	3 %	3 %	1800
Circuit 4	150 kV	AAAC-AL7 620	2	B	3 %	3 %	1800
Bliksemdraad 1		AACSR 241-AL3-39-A20SA	1	A	2 %	2 %	1800
Bliksemdraad 2		OPGW AFL-226/38	1	A	2 %	2 %	1800

Geleiders Ahead

Omschrijving	Spanning	Geleider Ahead	Bundel Ah	IJsg gebied	Toeslag gewicht	Toeslag diameter	Intrekwaarden P_{ahead}
Circuit 1	380 kV	AAAC-AL7 620	4	B	3 %	3 %	1800
Circuit 2	380 kV	AAAC-AL7 620	4	B	3 %	3 %	1800
Circuit 3	150 kV	AAAC-AL7 620	2	B	3 %	3 %	1800
Circuit 4	150 kV	AAAC-AL7 620	2	B	3 %	3 %	1800
Bliksemdraad 1		AACSR 241-AL3-39-A20SA	1	A	2 %	2 %	1800
Bliksemdraad 2		OPGW AFL-226/38	1	A	2 %	2 %	1800

Isolatoren (1)

Omschrijving	Ophanging	Gewicht [kN]	Lengte [m]	Windopp. [m ²]
Circuit 1	V-ketting	4,50	4,50	2,00
Circuit 2	V-ketting	4,50	4,50	2,00
Circuit 3	V-ketting	2,50	4,00	1,00
Circuit 4	V-ketting	2,50	4,00	1,00
Bliksemdraad 1	Vast (Bliksemdraad)	0,10	0,20	0,10
Bliksemdraad 2	Vast (Bliksemdraad)	0,10	0,20	0,10

1. Eigenschappen gelden voor geheel van de isolatorset

Ophanghoogte en positie in mast

Circuits	Aanduiding	Nummer	Ophanghoogte	Aangrippunt	Positie in mast Horizontale afstand
Circuit 1	10	380ct1f1	37,4 m	41,9 m	11,3 m
Circuit 1	11	380ct1f2	46,9 m	51,4 m	14,0 m
Circuit 1	12	380ct1f3	56,9 m	61,4 m	10,3 m
Circuit 2	20	380ct2f1	37,4 m	41,9 m	-11,3 m
Circuit 2	21	380ct2f2	46,9 m	51,4 m	-14,0 m
Circuit 2	22	380ct2f3	56,9 m	61,4 m	-10,3 m
Circuit 3	30	150ct3f1	37,9 m	41,9 m	5,0 m
Circuit 3	31	150ct3f2	47,4 m	51,4 m	7,7 m
Circuit 3	32	150ct3f3	57,4 m	61,4 m	4,0 m
Circuit 4	40	150ct4f1	37,9 m	41,9 m	-5,0 m
Circuit 4	41	150ct4f2	47,4 m	51,4 m	-7,7 m
Circuit 4	42	150ct4f3	57,4 m	61,4 m	-4,0 m
Bliksemdraad 1	1	bl1	62,7 m	62,9 m	16,0 m
Bliksemdraad 2	3	bl2	62,7 m	62,9 m	-16,0 m

Project: RLL-TLB380
 Tower: S+9_c
 Number: 1073

Hoogteaanpassing naastgelegen masten (aanpassing wind- en weight span)

	Back	Ahead	
Verhoging voor windbelasting	3,0 m	3,0 m	(positief: omhoog)
Verlaging voor verticale belasting	-9,0 m	-9,0 m	(negatief: omlaag, grotere weight span)
Verlaging:	Niet in 0,9EG-combinaties		

Hoogteafwijking mastbeeld naastgelegen masten en richtingsverandering t.o.v. Lijnrichting

Circuits	Aanduiding	Nummer	Hoogteverschil		Richtingsverandering	
			Δh_{back}	Δh_{ahead}	Δy_{back}	Δy_{ahead}
Circuit 1	10	380ct1f1	0,0	0,0 m	0,0	0,0 m
Circuit 1	11	380ct1f2	0,0	0,0 m	0,0	0,0 m
Circuit 1	12	380ct1f3	0,0	0,0 m	0,0	0,0 m
Circuit 2	20	380ct2f1	0,0	0,0 m	0,0	0,0 m
Circuit 2	21	380ct2f2	0,0	0,0 m	0,0	0,0 m
Circuit 2	22	380ct2f3	0,0	0,0 m	0,0	0,0 m
Circuit 3	30	150ct3f1	0,0	0,0 m	0,0	0,0 m
Circuit 3	31	150ct3f2	0,0	0,0 m	0,0	0,0 m
Circuit 3	32	150ct3f3	0,0	0,0 m	0,0	0,0 m
Circuit 4	40	150ct4f1	0,0	0,0 m	0,0	0,0 m
Circuit 4	41	150ct4f2	0,0	0,0 m	0,0	0,0 m
Circuit 4	42	150ct4f3	0,0	0,0 m	0,0	0,0 m
Bliksemdraad 1	1	bl1	0,0	0,0 m	0,0	0,0 m
Bliksemdraad 2	3	bl2	0,0	0,0 m	0,0	0,0 m

Lijn- en mastgegevens

	Back	Ahead
Ruling span $\sqrt{(\Sigma L^3/\Sigma L)}$	400,0	400,0 m
Lijnhoek	180 °	
Rotatie mast t.o.v. bissectrice	θ	0 °
Vaklengte	800	800 m
Hoogte onderkant mast t.o.v. maaiveld	0,5 m	
Beschouwde windrichtingen	α_1	0 °
Windrichtingen volgens:	α_2	45 °
<i>Geleiderbelastingen</i>	α_3	90 °
	α_4	135 °
	α_5	- °
	α_6	- °

Windrichtingen gelden t.o.v. hoofdrichting mastconstructie, niet t.o.v. bissectrice.

Windrichtingen en positieve richtingen belastingen

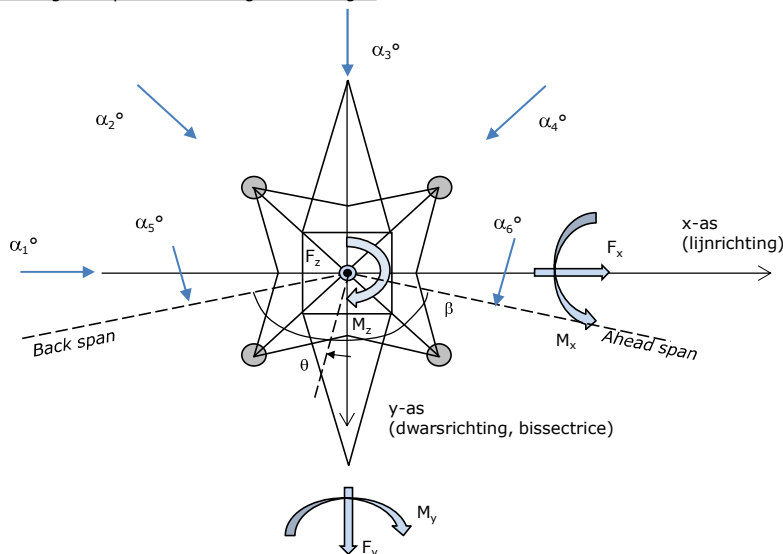

Beschouwd aantal windrichtingen	
1a	4
3	4
4	1
6	1
Overig	1

Project: RLL-TLB380
 Tower: S+9_c
 Number: 1073

Geleiderafval

		SPLS - torsie		SPLS - Enkelzijdige trek		5a - geleiderbreuk	
		Aanw.	Afw.	Aanw.	Afw.	Aanw.	Afw.
Circuit 1	380ct1f1	1	0	1	0	0,8	0
Circuit 1	380ct1f2	1	0	1	0	0,8	0
Circuit 1	380ct1f3	1	0	1	0	0,8	0
Circuit 2	380ct2f1	0	1	1	0	0,8	0
Circuit 2	380ct2f2	0	1	1	0	0,8	0
Circuit 2	380ct2f3	0	1	1	0	0,8	0
Circuit 3	150ct3f1	1	0	1	0	0,8	0
Circuit 3	150ct3f2	1	0	1	0	0,8	0
Circuit 3	150ct3f3	1	0	1	0	0,8	0
Circuit 4	150ct4f1	0	1	1	0	0,8	0
Circuit 4	150ct4f2	0	1	1	0	0,8	0
Circuit 4	150ct4f3	0	1	1	0	0,8	0
Bliksemdraad 1	b1	1	0	1	0	1	0
Bliksemdraad 2	b2	0	1	1	0	1	0

Belastingsituaties SPLS

Beschouwde situaties SPLS: SPLS voor steunmast niet van toepassing

Principe belastingssituaties:

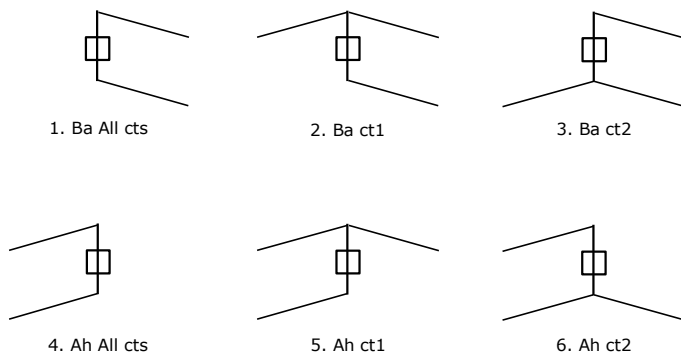

Belastingsituaties 5a. Geleiderbreuk

Beschouwde situaties geleiderbreuk 5a: 1 en 2, alle mogelijke situaties.

Principe belastingssituaties:

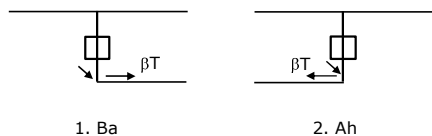

Project: RLL-TLB380
 Tower: S+9_c
 Number: 1073

Belastingsituaties 6. Bouw- en onderhoud

Onder 6a wordt de belasting door aanwezigheid lijnwagen of lijnfiets in combinatie met puntlast op traverse in rekening gebracht. Combinatie 6b bevat geen belastingen in geleider of op traverse. Deze combinatie is toegevoegd om te kunnen combineren met separate controle bordessen etc. De situaties worden in ULS en in iedere SPLS-situatie (in geval van hoekmast) toegepast.

	Fase	Bliksem
Lijnwagen	4,0 kN	2,0 kN
Puntlast op traverse	1,0 kN	1,0 kN

Beschouwde situaties bouw- en onderhoud 6a: 1 t/m 4, alle mogelijke situaties.

Aanwezigheid lijnwagen: Circuit, belasting tegelijk aanwezig in alle geleiders per circuit.

Principe belastingssituaties:

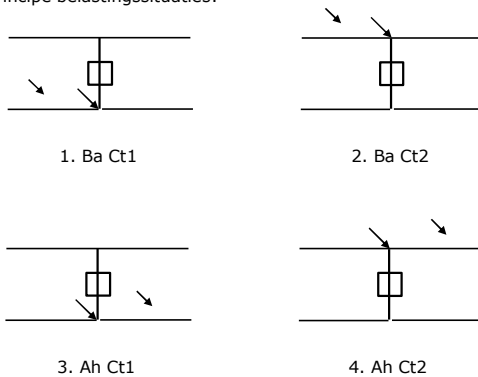

Belastingsituaties 8. Lijndansen als statische belasting

Geleider		
Steunmast fase	0,866 W	1,5 W
Steunmast bliksem	1,5 EDS	1,5 W
Hoekmast fase en bliksem	1,5 EDS	1,5 W

Considered situations galloping 8: 1 and 2, all possible situations

Belasting tegelijk aanwezig in alle geleiders van het circuit.

Principe belastingssituaties:

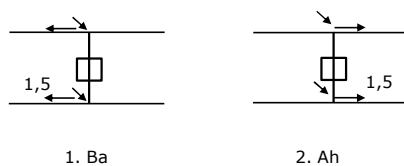

Belastingcombinatie 8. Lijndansen als dynamische belasting

Alleen van toepassing op hoek- en eindmasten
 Belasting bestaat uit EDS-trekbelasting in één van de geleiders aan één zijde van de mast
 Door gebruiker via het belastingsspectrum van tabel 4.11/NL.1 om te zetten naar spanningspectrum

Project: RLL-TLB380
 Tower: S+9_c
 Number: 1073

Mastconstructie

Eigenschappen

Masttype	Steunmast
Mastbenaming	S+9_c
Voetplaat t.o.v. maaiveld	0,5 m
Masthoogte t.o.v. voetplaat	65,7 m
Gewicht mast	512,0 kN

<i>Breedte en helling mast bij fundatie</i>	x-ri.	y-ri.
Pootsprei	12,04	12,04 m
Helling van de randstijl	0,150	0,150 -
Factor spatkracht	1,1	1,1 -

Berekening windbelasting

Dynamische invloed G_T	1,00 (<i>Masthoogte < 60 m</i>)
Windbelasting overhoeks op mastlichaam evenredig met:	$(A1C1\sin^2(\phi)+A2C2\cos^2(\phi))$
Windbelasting overhoeks op traverse evenredig met:	$(A1C1\sin^2(\phi)+A2C2\cos^2(\phi))$
Vergroting wind overhoeks mastlichaam	$(1+0,2\sin^2(2\phi))$
Vergroting wind overhoeks traverse	$(1+0,2\sin^2(2\phi))$
Factor wind evenwijdig t.o.v. haaks op traverse	0,4

Eigenschappen mastsecties langsrichting (vooraanzicht, yz-vlak)

Omschrijving	h [m]	b ₁ [m]	b ₂ [m]	Δh [m]	Δ _x [m]	A ₀ [m ²]	A ₁ [m ²]	χ = A ₁ /A ₀ [-]	C _t
Broekstuk	20,40	12,04	5,92	20,40	0,150	183,23	25,18	0,14	3,22
Eerste tussenstuk	33,10	5,92	4,55	12,70	0,054	66,50	14,15	0,21	2,88
Tweede tussenstuk	41,90	4,55	3,60	8,80	0,054	35,86	10,13	0,28	2,60
Bovenstuk 1	51,40	3,60	2,92	9,50	0,036	30,97	8,66	0,28	2,61
Bovenstuk 2	64,00	2,92	2,01	12,60	0,036	31,06	9,61	0,31	2,50
Topstuk	65,70	2,01		1,70		1,71	0,32	0,18	3,00
Ondertraverse	41,90	12,70		3,00		19,05	4,75	0,25	2,72
Middentraverse	51,40	16,34		3,00		24,51	6,81	0,28	2,62
Boventraverse	61,40	13,70	1,00	2,60		24,66	6,19	0,25	2,72

Eigenschappen mastsecties dwarsrichting (zijaanzicht, xz-vlak)

Omschrijving	h [m]	b ₁ [m]	b ₂ [m]	Δh [m]	Δ _x [m]	A ₀ [m ²]	A ₁ [m ²]	χ = A ₁ /A ₀ [-]	C _t
Broekstuk	20,40	12,04	5,92	20,40	0,150	183,23	25,18	0,14	3,22
Eerste tussenstuk	33,10	5,92	4,55	12,70	0,054	66,50	14,15	0,21	2,88
Tweede tussenstuk	41,90	4,55	3,60	8,80	0,054	35,86	10,13	0,28	2,60
Bovenstuk 1	51,40	3,60	2,92	9,50	0,036	30,97	8,66	0,28	2,61
Bovenstuk 2	64,00	2,92	2,01	12,60	0,036	31,06	9,61	0,31	2,50
Topstuk	65,70	2,01		1,70		1,71	0,32	0,18	3,00
Ondertraverse	41,90	12,70		3,00		19,05	4,75	0,25	2,72
Middentraverse	51,40	16,34		3,00		24,51	6,81	0,28	2,62
Boventraverse	61,40	13,70	1,00	2,60		24,66	6,19	0,25	2,72

NB: oppervlakte traverse dwarsrichting wordt in berekening gereduceerd.

Project: RLL-TLB380
 Tower: S+9_c
 Number: 1073

Windoppervlak feeders telecominstallaties

Onderdeel	A (m ² /m)	Factor	Δh	A ₁
Broekstuk	0,14	0,71	20,4	2,0
Eerste tussenstuk	0,14	0,71	12,7	1,3
Tweede tussenstuk	0,14	0,71	8,8	0,9
Bovenstuk 1				
Bovenstuk 2				

Invoer antennes

Omschrijving	A (m ²)	h (m)	C _r (m)
Antenne top			
Antenne o.t.	4,7	48,2	1,5

Belastingen mastsectie langsrichting (x-richting) per windrichting

Omschrijving	P _w [kN/m ²]	F _{x1} [kN]	F _{x2} [kN]	F _{x3} [kN]	F _{x4} [kN]	h _{ef} [m]	M _{y1} [kNm]	M _{y2} [kNm]	M _{y3} [kNm]	M _{y4} [kNm]
Broekstuk	0,71	57,2	48,5	0,0	-48,5	10,2	583,5	495,1	0,0	-495,1
Eerste tussenstuk	0,96	38,9	33,0	0,0	-33,0	26,8	1041,0	883,3	0,0	-883,3
Tweede tussenstuk	1,05	27,7	23,5	0,0	-23,5	37,5	1037,8	880,6	0,0	-880,6
Bovenstuk 1	1,12	25,3	21,4	0,0	-21,4	46,7	1178,3	999,8	0,0	-999,8
Bovenstuk 2	1,18	28,3	24,0	0,0	-24,0	57,7	1634,8	1387,1	0,0	-1387,1
Topstuk	1,21	1,1	1,0	0,0	-1,0	64,9	74,5	63,3	0,0	-63,3
Ondertraverse	1,09	28,2	16,8	0,0	-16,8	42,9	1211,6	719,6	0,0	-719,6
Middentraverse	1,15	41,0	24,3	0,0	-24,3	52,4	2145,9	1274,6	0,0	-1274,6
Boventraverse	1,20	40,4	24,0	0,0	-24,0	62,3	2517,5	1495,3	0,0	-1495,3
Totaal	288,2	216,6	216,6	0,0	-216,6		11424,8	8198,8	0,0	-8198,8

Belastingen mastsectie dwarsrichting (y-richting) per windrichting

Omschrijving	P _w [kN/m ²]	F _{y1} [kN]	F _{y2} [kN]	F _{y3} [kN]	F _{y4} [kN]	h _{ef} [m]	M _{x1} [kNm]	M _{x2} [kNm]	M _{x3} [kNm]	M _{x4} [kNm]
Broekstuk	0,71	0,0	48,5	57,2	48,5	10,2	0,0	495,1	583,5	495,1
Eerste tussenstuk	0,96	0,0	33,0	38,9	33,0	26,8	0,0	883,3	1041,0	883,3
Tweede tussenstuk	1,05	0,0	23,5	27,7	23,5	37,5	0,0	880,6	1037,8	880,6
Bovenstuk 1	1,12	0,0	21,4	25,3	21,4	46,7	0,0	999,8	1178,3	999,8
Bovenstuk 2	1,18	0,0	24,0	28,3	24,0	57,7	0,0	1387,1	1634,8	1387,1
Topstuk	1,21	0,0	1,0	1,1	1,0	64,9	0,0	63,3	74,5	63,3
Ondertraverse	1,09	0,0	16,8	11,3	16,8	42,9	0,0	719,6	484,6	719,6
Middentraverse	1,15	0,0	24,3	16,4	24,3	52,4	0,0	1274,6	858,4	1274,6
Boventraverse	1,20	0,0	24,0	16,2	24,0	62,3	0,0	1495,3	1007,0	1495,3
Totaal	0,0	0,0	216,6	222,4	216,6		0,0	8198,8	7899,8	8198,8

Resulterende belastingen vanuit mastconstructie incl. antenne zonder geleiders niveau fundatie (kar. waarde)

Belasting / windrichting	F _x [kN]	F _y [kN]	F _z [kN]	M _x [kNm]	M _y [kNm]	M _z [kNm]
Permanente belasting	0	0	512	0	0	0
Windrichting 0°	296	0	0	0	11807	0
Windrichting 45°	222	222	0	8469	8469	0
Windrichting 90°	0	230	0	8282	0	0
Windrichting 135°	-222	222	0	8469	-8469	0

Project: RLL-TLB380
 Tower: S+9_c
 Number: 1073

Tussenresultaten geleiderbelastingen

Geleiders back

Circuit	Geleider	Diameter [mm]	A [mm ²]	G [N/m]	E [N/mm ²]	αT [-]
Circuit 1	AAAC-AL7 620	32,4	621,0	17,71	56000	2,30E-05
Circuit 2	AAAC-AL7 620	32,4	621,0	17,71	56000	2,30E-05
Circuit 3	AAAC-AL7 620	32,4	621,0	17,71	56000	2,30E-05
Circuit 4	AAAC-AL7 620	32,4	621,0	17,71	56000	2,30E-05
Bliksemdraad 1	AACSR 241-AL3-39-A20SA	21,8	281,0	9,38	70165	1,97E-05
Bliksemdraad 2	OPGW AFL-226/38	21,7	264,0	9,13	72000	1,98E-05

Geleiders ahead

Circuit	Geleider	Diameter [mm]	A [mm ²]	G [N/m]	E [N/mm ²]	αT [-]
Circuit 1	AAAC-AL7 620	32,4	621,0	17,71	56000	2,30E-05
Circuit 2	AAAC-AL7 620	32,4	621,0	17,71	56000	2,30E-05
Circuit 3	AAAC-AL7 620	32,4	621,0	17,71	56000	2,30E-05
Circuit 4	AAAC-AL7 620	32,4	621,0	17,71	56000	2,30E-05
Bliksemdraad 1	AACSR 241-AL3-39-A20SA	21,8	281,0	9,38	70165	1,97E-05
Bliksemdraad 2	OPGW AFL-226/38	21,7	264,0	9,13	72000	1,98E-05

Verticale belasting back

Circuit	Bundel [-]	Toeslag [%]	W _{z,G} [N/m]	IJsg gebied	Formule	W _{z,ijs} [N/m]	W _{z,ijs,bundel} [N/m]
Circuit 1	4	3	73,0		B 4+0,2d	10,5	41,9
Circuit 2	4	3	73,0		B 4+0,2d	10,5	41,9
Circuit 3	2	3	36,5		B 4+0,2d	10,5	21,0
Circuit 4	2	3	36,5		B 4+0,2d	10,5	21,0
Bliksemdraad 1	1	2	9,6		A 15+0,4d	23,7	23,7
Bliksemdraad 2	1	2	9,3		A 15+0,4d	23,7	23,7

Verticale belasting ahead

Circuit	Bundel [-]	Toeslag [%]	W _{z,G} [N/m]	IJsg gebied	Formule	W _{z,ijs} [N/m]	W _{z,ijs,bundel} [N/m]
Circuit 1	4	3	73,0		B 4+0,2d	10,5	41,9
Circuit 2	4	3	73,0		B 4+0,2d	10,5	41,9
Circuit 3	2	3	36,5		B 4+0,2d	10,5	21,0
Circuit 4	2	3	36,5		B 4+0,2d	10,5	21,0
Bliksemdraad 1	1	2	9,6		A 15+0,4d	23,7	23,7
Bliksemdraad 2	1	2	9,3		A 15+0,4d	23,7	23,7

Isolatoren

Geleider	G _{isolator} [kN]	Aantal	F _{v,iso} [kN]	Lengte [m]	Windopp. [m ²]	Windhoogte [m]	Stuwdruk [kN/m ²]	Vormfactor	F _{th,iso} [kN]
380ct1f1	4,50	1	4,5	4,5	2,0	40,15	1,07	1,2	2,57
380ct1f2	4,50	1	4,5	4,5	2,0	49,65	1,13	1,2	2,72
380ct1f3	4,50	1	4,5	4,5	2,0	59,65	1,19	1,2	2,85
380ct2f1	4,50	1	4,5	4,5	2,0	40,15	1,07	1,2	2,57
380ct2f2	4,50	1	4,5	4,5	2,0	49,65	1,13	1,2	2,72
380ct2f3	4,50	1	4,5	4,5	2,0	59,65	1,19	1,2	2,85
150ct3f1	2,50	1	2,5	4,0	1,0	40,40	1,07	1,2	1,29
150ct3f2	2,50	1	2,5	4,0	1,0	49,90	1,14	1,2	1,36
150ct3f3	2,50	1	2,5	4,0	1,0	59,90	1,19	1,2	1,43
150ct4f1	2,50	1	2,5	4,0	1,0	40,40	1,07	1,2	1,29
150ct4f2	2,50	1	2,5	4,0	1,0	49,90	1,14	1,2	1,36
150ct4f3	2,50	1	2,5	4,0	1,0	59,90	1,19	1,2	1,43
bl1	0,10	1	0,1	0,2	0,1	63,30	1,21	1,2	0,14
bl2	0,10	1	0,1	0,2	0,1	63,30	1,21	1,2	0,14

Project: RLL-TLB380
 Tower: S+9_c
 Number: 1073

Windbelasting back

Geleider	hoogte		Stuwdruk [kN/m ²]	G _{c_dwars} [-]	G _{c_trek} [-]	C _c [-]	d _{toeslag} [mm]	W _y [N/m]	W _{y,vak} [N/m]	D _{ijs,toeslag} [mm]	W _{y,ijs} [N/m]	W _{y,ijs,vak} [N/m]
	wind [m]	hoogte										
380ct1f1	32,0		1,01	0,58	0,58	1,00	33,37	78,2	78,2	51,8	145,8	145,8
380ct1f2	41,5		1,08	0,60	0,60	0,98	33,37	84,9	84,9	51,8	162,1	162,1
380ct1f3	51,5		1,14	0,62	0,62	0,96	33,37	90,5	90,5	51,8	176,4	176,4
380ct2f1	32,0		1,01	0,58	0,58	1,00	33,37	78,2	78,2	51,8	145,8	145,8
380ct2f2	41,5		1,08	0,60	0,60	0,98	33,37	84,9	84,9	51,8	162,1	162,1
380ct2f3	51,5		1,14	0,62	0,62	0,96	33,37	90,5	90,5	51,8	176,4	176,4
150ct3f1	32,5		1,01	0,58	0,58	1,00	33,37	39,3	39,3	51,8	73,4	73,4
150ct3f2	42,0		1,08	0,60	0,60	0,98	33,37	42,6	42,6	51,8	81,4	81,4
150ct3f3	52,0		1,15	0,62	0,62	0,96	33,37	45,4	45,4	51,8	88,5	88,5
150ct4f1	32,5		1,01	0,58	0,58	1,00	33,37	39,3	39,3	51,8	73,4	73,4
150ct4f2	42,0		1,08	0,60	0,60	0,98	33,37	42,6	42,6	51,8	81,4	81,4
150ct4f3	52,0		1,15	0,62	0,62	0,96	33,37	45,4	45,4	51,8	88,5	88,5
bl1	57,3		1,18	0,63	0,63	1,18	22,24	19,3	19,3	63,1	55,9	55,9
bl2	57,3		1,18	0,63	0,63	1,18	22,13	19,3	19,3	63,0	55,9	55,9

Windbelasting ahead

Geleider	hoogte		Stuwdruk [kN/m ²]	G _{c_dwars} [-]	G _{c_trek} [-]	C _c [-]	d _{toeslag} [mm]	W _y [N/m]	W _{y,vak} [N/m]	D _{ijs,toeslag} [mm]	W _{y,ijs} [N/m]	W _{y,ijs,vak} [N/m]
	wind [m]	hoogte										
380ct1f1	32,0		1,01	0,58	0,58	1,00	33,37	78,2	78,2	51,8	145,8	145,8
380ct1f2	41,5		1,08	0,60	0,60	0,98	33,37	84,9	84,9	51,8	162,1	162,1
380ct1f3	51,5		1,14	0,62	0,62	0,96	33,37	90,5	90,5	51,8	176,4	176,4
380ct2f1	32,0		1,01	0,58	0,58	1,00	33,37	78,2	78,2	51,8	145,8	145,8
380ct2f2	41,5		1,08	0,60	0,60	0,98	33,37	84,9	84,9	51,8	162,1	162,1
380ct2f3	51,5		1,14	0,62	0,62	0,96	33,37	90,5	90,5	51,8	176,4	176,4
150ct3f1	32,5		1,01	0,58	0,58	1,00	33,37	39,3	39,3	51,8	73,4	73,4
150ct3f2	42,0		1,08	0,60	0,60	0,98	33,37	42,6	42,6	51,8	81,4	81,4
150ct3f3	52,0		1,15	0,62	0,62	0,96	33,37	45,4	45,4	51,8	88,5	88,5
150ct4f1	32,5		1,01	0,58	0,58	1,00	33,37	39,3	39,3	51,8	73,4	73,4
150ct4f2	42,0		1,08	0,60	0,60	0,98	33,37	42,6	42,6	51,8	81,4	81,4
150ct4f3	52,0		1,15	0,62	0,62	0,96	33,37	45,4	45,4	51,8	88,5	88,5
bl1	57,3		1,18	0,63	0,63	1,18	22,24	19,3	19,3	63,1	55,9	55,9
bl2	57,3		1,18	0,63	0,63	1,18	22,13	19,3	19,3	63,0	55,9	55,9

Project: RLL-TLB380
 Masttype: S+9_c
 Mast: 1073

Auteur: TBR
 Versie: v11.8

Geleiderbelastingen

Uitgangspunten

Betrouwbaarheidsniveau Nieuwbouw CC2
 Referentieperiode 50 jaar

ULS (bezwijksterkte)		NEN-EN50341-2-15:2019						
Belastingsgeval	omschrijving	Temp °C	γ_G		γ_Q			γ_a A_k
			$G_{k,mast}$	$G_{k,geleider}$	Q_{pk}	Q_{wk}	Q_{ik}	
ULS 1a	Wind	10°	1,20	1,20	0,00	1,50	0,00	0,0
ULS 1a_0,9	Wind 0,9Gk alleen mast	10°	0,90	1,20	0,00	1,50	0,00	0,0
ULS 1a_0,9_0,9	Wind 0,9Gk ook geleider	10°	0,90	0,90	0,00	1,50	0,00	0,0
ULS 3	Wind+ijs	-5°	1,20	1,20	0,00	0,45	1,50	0,0
ULS 3_0,9	Wind+ijs 0,9	-5°	0,90	1,20	0,00	0,45	1,50	0,0
ULS 4	Koude+wind	-20°	1,20	1,20	0,00	0,30	0,00	0,0
ULS 4_0,9	Koude+wind 0,9	-20°	0,90	1,20	0,00	0,30	0,00	0,0
ULS 5a	Torsiebelastingen	10°	1,00	1,00	1,00	0,00	0,00	1,0
ULS 5b	Longitudinale belastingen	10°	1,00	1,00	0,00	0,00	0,00	1,0
ULS 6	Bouw en onderhoud	5°	1,20	1,20	1,50	0,30	0,00	0,0
ULS 6_0,9	Bouw en onderhoud	5°	1,20	1,20	0,00	0,30	0,00	0,0
ULS 7	Permanent	10°	1,35	1,35	0,00	0,00	0,00	0,0
ULS 8	Special	10°	1,00	1,00	0,00	0,00	0,00	1,0
SPLS (Bezwijksterkte, enkel voor hoekmasten: afwezigheid geleiders)			γ_G		γ_Q			
			G_k		Q_{pk}	Q_{wk}	Q_{ik}	A_k
SPLS 1a	Wind	10°	1,20	1,20	0,0	0,78	0,00	0,0
SPLS 1a_0,9	Wind 0,9	10°	0,90	1,20	0,0	0,78	0,00	0,0
SPLS 1a_0,9_0,9	Wind 0,9	10°	0,90	0,90	0,0	0,78	0,00	0,0
SPLS 3	Wind+ijs	-5°	1,20	1,20	0,0	0,36	0,34	0,0
SPLS 3_0,9	Wind+ijs 0,9	-5°	0,90	1,20	0,0	0,36	0,34	0,0
SPLS 4	Koude+wind	-20°	1,20	1,20	0,0	0,24	0,00	0,0
SPLS 4_0,9	Koude+wind 0,9	-20°	0,90	1,20	0,0	0,24	0,00	0,0
SPLS 6	Bouw en onderhoud	5°	1,20	1,20	1,2	0,24	0,0	0,0
SPLS 6_0,9	Bouw en onderhoud	5°	1,20	1,20	0,0	0,24	0,0	0,0
SLS (controle van de vervormingen, vermoeiing, EDS)			G_k		Q_{pk}	Q_{wk}	Q_{ik}	A_k
SLS 1a	Wind	10°	1,00	1,00	0,0	1,00	0,0	0,0
SLS 3	Wind+ijs	-5°	1,00	1,00	0,0	0,30	1,00	0,0
SLS 4	Wind	-20°	1,00	1,00	0,0	0,20	0,0	0,0
SLS 6	Bouw en onderhoud	5°	1,00	1,00	0,0	0,20	0,0	0,0
SLS 7	PB (EDS, geen wind)	10°	1,00	1,00	0,0	0,00	0,0	0,0

Aantal windrichtingen 4
 Aantal belastingcombinaties ULS 62
 Aantal belastingcombinaties SPLS 0
 Aantal belastingcombinaties SLS 11
 Aantal knooplasten 1022

Project: RLL-TLB380
 Masttype: S+9_c
 Mast: 1073

Samenvattingstabellen geleiderbelastingen

In de onderstaande vier tabellen is weergegeven:

- De maximale geleiderbelasting in het globale assenstelsel, gesplitst in aandeel van back en ahead span
- De gecombineerde geleiderbelasting (Ba+Ah) in het globale assenstelsel met in het lokale assenstelsel de maximaal optredende trekkracht. Componenten Fx en Fy als absolute waarde
- De alledaagse (EDS) waarden van de gecombineerde geleiderbelastingen (Ba+Ah) met bijbehorende trekkrachten
- Controle op uplift, waar een negatieve waarde duidt op uplift

Maximale waarden voor back en ahead span

Geleider	Fx_ba [kN]	Fx_ah [kN]	Fy_ba [kN]	Fy_ah [kN]	Fz_ba [kN]	Fz_ah [kN]
bl1	-66,7	66,7	5,9	5,9	11,0	11,0
380ct1f1	-260,7	260,7	25,4	25,4	38,7	38,7
380ct1f2	-264,3	264,3	27,5	27,5	38,7	38,7
380ct1f3	-267,6	267,6	29,3	29,3	38,8	38,8
380ct2f1	-260,7	260,7	25,4	25,4	38,7	38,7
380ct2f2	-264,3	264,3	27,5	27,5	38,7	38,7
380ct2f3	-267,6	267,6	29,3	29,3	38,8	38,8
150ct3f1	-130,4	130,4	12,8	12,8	19,7	19,7
150ct3f2	-132,2	132,2	13,8	13,8	19,7	19,7
150ct3f3	-133,9	133,9	14,7	14,7	19,7	19,7
150ct4f1	-130,4	130,4	12,8	12,8	19,7	19,7
150ct4f2	-132,2	132,2	13,8	13,8	19,7	19,7
150ct4f3	-133,9	133,9	14,7	14,7	19,7	19,7
bl2	-65,7	65,7	5,9	5,9	10,9	10,9

Min. Weight span (m)

Weight spar Combinatie1

Geleider	SLS 1a	SLS 4	SLS 7
bl1	481,0	497,7	481,0
380ct1f1	481,0	495,8	481,0
380ct1f2	481,0	496,0	481,0
380ct1f3	481,0	496,3	481,0
380ct2f1	481,0	495,8	481,0
380ct2f2	481,0	496,0	481,0
380ct2f3	481,0	496,3	481,0
150ct3f1	481,0	495,8	481,0
150ct3f2	481,0	496,1	481,0
150ct3f3	481,0	496,3	481,0
150ct4f1	481,0	495,8	481,0
150ct4f2	481,0	496,1	481,0
150ct4f3	481,0	496,3	481,0
bl2	481,0	498,0	481,0

Max. Weight span (m)

Weight spar Combinatie1

Geleider	ULS 1a	ULS 3
bl1	571,2	463,8
380ct1f1	517,1	478,0
380ct1f2	522,1	479,0
380ct1f3	526,3	480,1
380ct2f1	517,1	478,0
380ct2f2	522,1	479,0
380ct2f3	526,3	480,1
150ct3f1	517,4	478,0
150ct3f2	522,3	479,1
150ct3f3	526,5	480,1
150ct4f1	517,4	478,0
150ct4f2	522,3	479,1
150ct4f3	526,5	480,1
bl2	573,7	463,4

Omhullende weight span over alle combinaties (incl. 0,9 combinaties)

Voor alle geleiders

Max. weight span	573,7 m
Min. weight span	324,5 m

Wind / Weight span verhouding

	1,434 -
	0,811 -

Project: RLL-TLB380
 Masttype: S+9_c
 Mast: 1073

Maximale waarden back+ahead span Maximale waarden trekkracht geleider

Geleider	Maximale waarden back+ahead span			Maximale waarden trekkracht geleider	
	Fx [kN]	Fy [kN]	Fz [kN]	Ft_ba [kN]	Ft_ah [kN]
bl1	25,8	11,8	21,9	-66,7	66,7
380ct1f1	105,1	50,8	77,3	-260,7	260,7
380ct1f2	105,1	55,0	77,5	-264,3	264,3
380ct1f3	105,1	58,6	77,6	-267,6	267,6
380ct2f1	105,1	50,8	77,3	-260,7	260,7
380ct2f2	105,1	55,0	77,5	-264,3	264,3
380ct2f3	105,1	58,6	77,6	-267,6	267,6
150ct3f1	52,5	25,5	39,0	-130,4	130,4
150ct3f2	52,5	27,6	39,0	-132,2	132,2
150ct3f3	52,5	29,4	39,1	-133,9	133,9
150ct4f1	52,5	25,5	39,0	-130,4	130,4
150ct4f2	52,5	27,6	39,0	-132,2	132,2
150ct4f3	52,5	29,4	39,1	-133,9	133,9
bl2	25,1	11,8	21,8	-65,7	65,7

EDS-belastingen geleiders

Geleider	EDS-belastingen geleiders				
	Fx [kN]	Fy [kN]	Fz [kN]	Ft_ba [kN]	Ft_ah [kN]
bl1	0,0	0,0	4,7	-17,2	17,2
380ct1f1	0,0	0,0	39,6	-131,3	131,3
380ct1f2	0,0	0,0	39,6	-131,3	131,3
380ct1f3	0,0	0,0	39,6	-131,3	131,3
380ct2f1	0,0	0,0	39,6	-131,3	131,3
380ct2f2	0,0	0,0	39,6	-131,3	131,3
380ct2f3	0,0	0,0	39,6	-131,3	131,3
150ct3f1	0,0	0,0	20,0	-65,7	65,7
150ct3f2	0,0	0,0	20,0	-65,7	65,7
150ct3f3	0,0	0,0	20,0	-65,7	65,7
150ct4f1	0,0	0,0	20,0	-65,7	65,7
150ct4f2	0,0	0,0	20,0	-65,7	65,7
150ct4f3	0,0	0,0	20,0	-65,7	65,7
bl2	0,0	0,0	4,6	-16,8	16,8

Controle uplift SLS-wind

Combinatie: Geleider	Controle uplift SLS-wind	
	Fz_ba [kN]	Fz_ah [kN]
SLS 4		
bl1	2,4	2,4
380ct1f1	20,3	20,3
380ct1f2	20,3	20,3
380ct1f3	20,4	20,4
380ct2f1	20,3	20,3
380ct2f2	20,3	20,3
380ct2f3	20,4	20,4
150ct3f1	10,3	10,3
150ct3f2	10,3	10,3
150ct3f3	10,3	10,3
150ct4f1	10,3	10,3
150ct4f2	10,3	10,3
150ct4f3	10,3	10,3
bl2	2,4	2,4

Project: RLL-TLB380
 Masttype: S+9_c
 Mast: 1073

ULS-fundatiebelasting combinatie 1 en 3 wind haaks op de lijn of bissectrice en EDS, vanuit geleiders

Combinatie	Combination	F_x [kN]	F_y [kN]	F_z [kN]	M_x [kNm]	M_y [kNm]	M_z [kNm]
ULS 1a_90		0	517	475	27182	0	0
ULS 1a_0,9_90		0	517	342	27181	0	0
ULS 3_90		0	293	743	15516	0	0
ULS 3_0,9_90		0	293	592	15515	0	0
SLS 7		0	0	367	2	0	0

ULS-fundatiebelasting combinatie 1 en 3 wind haaks op de lijn of bissectrice en EDS, totaal geleiders en mast

Combinatie	F_x [kN]	F_y [kN]	F_z [kN]	M_x [kNm]	M_y [kNm]	M_z [kNm]
ULS 1a_90	0	863	1089	39605	0	0
ULS 3_90	0	397	1357	19243	0	0
SLS 7	0	0	879	2	0	0

Fundatiebelastingen, selectie belastingcombinaties op basis grootste waarde

Combinatie	F_x [kN]	F_y [kN]	F_z [kN]	M_x [kNm]	M_y [kNm]	M_z [kNm]
ULS 1a_90	0	863	1089	39605	0	0
ULS 1a_0	463	0	1053	2	18689	0
ULS 5a Ba 11	105	0	876	-244	5401	1471
ULS 1a_45	347	600	1065	26695	13396	0

Noot: grootste waarden kunnen in meerdere combinaties voorkomen, een combinatie is weergegeven.

Oplegreacties op fundering per randstijl

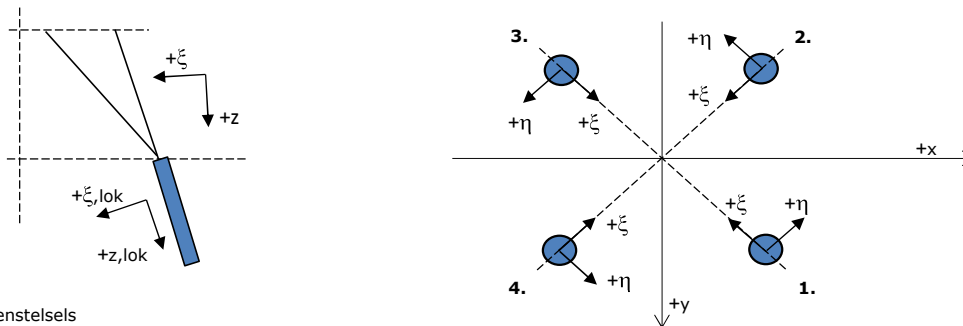

Assenstelsels

Maximale drukbelasting

Stijl	Combinatie	R_x [kN]	R_y [kN]	R_z [kN]	R_η [kN]	R_ξ [kN]	$R_{\xi,lok}$ [kN]	$R_{z,lok}$ [kN]
1	ULS 1a_45	313	286	1931	20	-424	-14	1974
2	ULS 1a_0	159	-171	1039	9	-234	-13	1062
3	ULS 8 Ba	-124	-162	979	-27	-202	6	1001
4	ULS 1a_135	-313	286	1931	-20	-424	-14	1974

Maximale trekbelasting

Stijl	Combinatie	R_x [kN]	R_y [kN]	R_z [kN]	R_η [kN]	R_ξ [kN]	$R_{\xi,lok}$ [kN]	$R_{z,lok}$ [kN]
1	ULS 8 Ba	-38	-75	-458	26	80	-17	-468
2	ULS 1a_0,9_0,9_135	-240	212	-1485	20	320	5	-1518
3	ULS 1a_0,9_0,9_45	240	212	-1485	-20	320	5	-1518
4	ULS 1a_0,9_0,9_0	86	-98	-595	-9	130	4	-608

Maximale torsiebelasting (positief)

Stijl	Combinatie	R_x [kN]	R_y [kN]	R_z [kN]	R_η [kN]	R_ξ [kN]	$R_{\xi,lok}$ [kN]	$R_{z,lok}$ [kN]
1	ULS 5a Ah 21	42	-31	5	52	-8	-6	5
2	ULS 5a Ba 11	34	-104	453	50	-97	-1	463
3	ULS 5a Ba 11	-42	31	5	52	-8	-7	5
4	ULS 5a Ah 21	-34	104	453	50	-97	-1	464

Maximale torsiebelasting (negatief)

Stijl	Combinatie	R_x [kN]	R_y [kN]	R_z [kN]	R_η [kN]	R_ξ [kN]	$R_{\xi,lok}$ [kN]	$R_{z,lok}$ [kN]
1	ULS 5a Ba 21	34	104	453	-50	-97	-1	464
2	ULS 5a Ah 11	42	31	5	-52	-8	-7	5
3	ULS 5a Ah 11	-34	-104	453	-50	-97	-1	463
4	ULS 5a Ba 21	-42	-31	5	-52	-8	-6	5

Project: RLL-TLB380
 Masttype: S+9_c
 Mast: 1073

Combinatie Ftrek+Fhor

Stijl	Combinatie	R _x [kN]	R _y [kN]	R _z [kN]	R _η [kN]	R _ξ [kN]	R _{ξ,lok} [kN]	R _{z,lok} [kN]
1	ULS 8 Ba	-38	-75	-458	26	80	-17	-468
2	ULS 1a_0,9_0,9_90	-242	186	-1467	39	303	-8	-1499
3	ULS 1a_0,9_0,9_90	242	186	-1467	-39	303	-8	-1499
4	ULS 1a_0,9_0,9_0	86	-98	-595	-9	130	4	-608

Permanente belasting

Stijl	Combinatie	R _x [kN]	R _y [kN]	R _z [kN]	R _η [kN]	R _ξ [kN]	R _{ξ,lok} [kN]	R _{z,lok} [kN]
1	SLS 7	36	36	220	0	-51	-5	225
2	SLS 7	36	-36	220	0	-51	-5	225
3	SLS 7	-36	-36	220	0	-51	-5	225
4	SLS 7	-36	36	220	0	-51	-5	225

Omhullenden ongeacht stijl

Belasting	Combinatie	R _x [kN]	R _y [kN]	R _z [kN]	R _η [kN]	R _ξ [kN]	R _{ξ,lok} [kN]	R _{z,lok} [kN]
Max. druk	ULS 1a_45	313	286	1931	20	-424	-14	1974
Max. trek	ULS 1a_0,9_0,9_45	240	212	-1485	-20	320	5	-1518
Max. pos. torsie	ULS 5a Ah 21	42	-31	5	52	-8	-6	5
Max. neg. torsie	ULS 5a Ba 21	-42	-31	5	-52	-8	-6	5
Comb. trek+torsie	ULS 1a_0,9_0,9_90	-242	186	-1467	39	303	-8	-1499

Maximale trekbelasting SLS

Stijl	Combinatie	R _x [kN]	R _y [kN]	R _z [kN]	R _η [kN]	R _ξ [kN]	R _{ξ,lok} [kN]	R _{z,lok} [kN]
1	SLS 7	36	36	220	0	-51	-5	225
2	SLS 1a_135	-143	125	-888	13	189	1	-908
3	SLS 1a_45	143	125	-888	-13	189	1	-908
4	SLS 1a_0	41	-49	-297	-6	64	1	-304

Maximale drukbelasting SLS

Stijl	Combinatie	R _x [kN]	R _y [kN]	R _z [kN]	R _η [kN]	R _ξ [kN]	R _{ξ,lok} [kN]	R _{z,lok} [kN]
1	SLS 1a_45	216	198	1331	13	-293	-10	1361
2	SLS 1a_0	113	-122	737	6	-166	-10	753
3	SLS 7	-36	-36	220	0	-51	-5	225
4	SLS 1a_135	-216	198	1331	-13	-293	-10	1361

Project: RLL-TLB380
Masttype: S+9_c
Mast: 1073

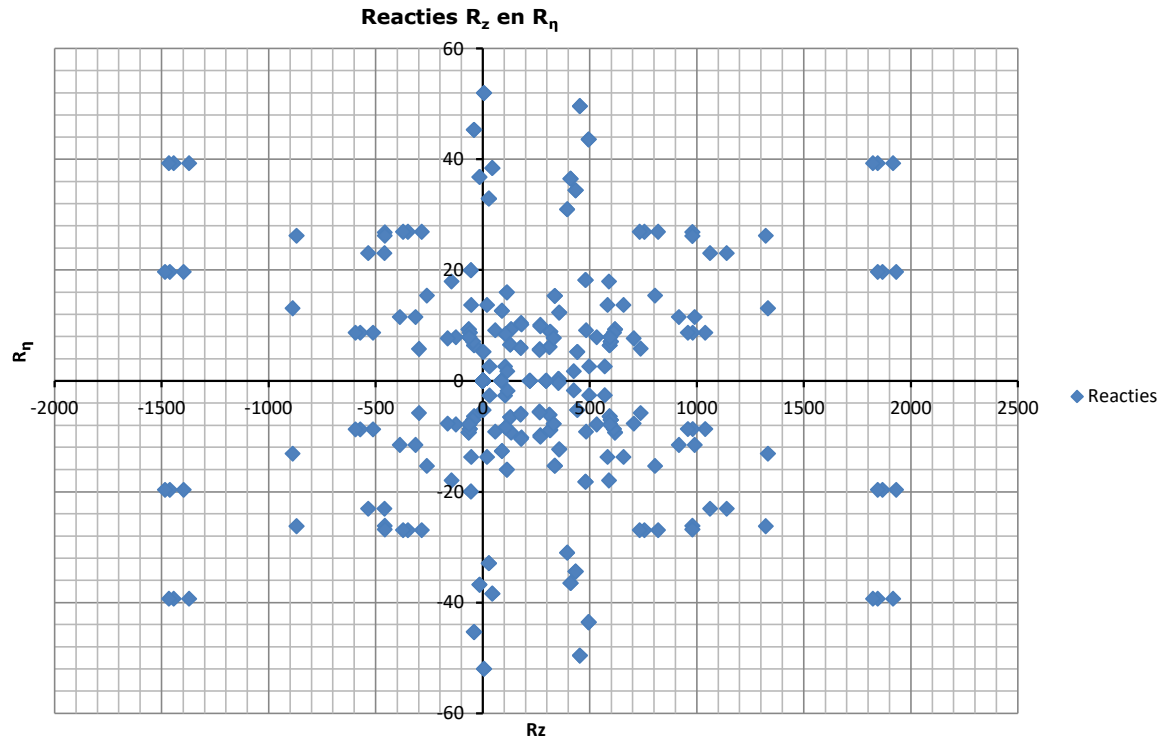

Project: RLL-TLB380
 Tower: S+12_c
 Number: 1077

Auteur: TBR
 Versie: v11.8

Geleiderbelastingen

Algemeen

Benaming S+12_c
 Masttype Steunmast
 Aantal circuits 4
 Configuratie 4-circuit-dubbel verticaal
 Aantal bliksemgeleiders 2

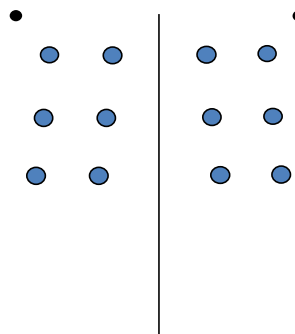

Configuratie geleiders

Uitgangspunten

Norm NEN-EN50341-2-15:2019
 Gevolgklasse initieel CC2
 Betrouwbaarheidsniveau initieel Nieuwbouw
 Referentieperiode initieel 50 jaar
 Referentieperiode na aanpassing CC2
 Betrouwbaarheidsniveau na aanpassing n.v.t.
 Referentieperiode na aanpassing 50 jaar
 Windgebied III
 Windsnelheid (m/s) 24,5 m/s
 Terreincategorie II
 Reductiefactor c_{dir} 1,00
 IJsg gebied fasegeleider B
 IJsg gebied bliksemgeleider A

Geleiders Back

Omschrijving	Spanning	Geleider Back	Bundel Ba	IJsg gebied	Toeslag gewicht	Toeslag diameter	Intrekwaarden P_{back}
Circuit 1	380 kV	AAAC-AL7 620	4	B	3 %	3 %	1800
Circuit 2	380 kV	AAAC-AL7 620	4	B	3 %	3 %	1800
Circuit 3	150 kV	AAAC-AL7 620	2	B	3 %	3 %	1800
Circuit 4	150 kV	AAAC-AL7 620	2	B	3 %	3 %	1800
Bliksemdraad 1		AACSR 241-AL3-39-A20SA	1	A	2 %	2 %	1800
Bliksemdraad 2		OPGW AFL-226/38	1	A	2 %	2 %	1800

Geleiders Ahead

Omschrijving	Spanning	Geleider Ahead	Bundel Ah	IJsg gebied	Toeslag gewicht	Toeslag diameter	Intrekwaarden P_{ahead}
Circuit 1	380 kV	AAAC-AL7 620	4	B	3 %	3 %	1800
Circuit 2	380 kV	AAAC-AL7 620	4	B	3 %	3 %	1800
Circuit 3	150 kV	AAAC-AL7 620	2	B	3 %	3 %	1800
Circuit 4	150 kV	AAAC-AL7 620	2	B	3 %	3 %	1800
Bliksemdraad 1		AACSR 241-AL3-39-A20SA	1	A	2 %	2 %	1800
Bliksemdraad 2		OPGW AFL-226/38	1	A	2 %	2 %	1800

Isolatoren (1)

Omschrijving	Ophanging	Gewicht [kN]	Lengte [m]	Windopp. [m ²]
Circuit 1	V-ketting	4,50	4,50	2,00
Circuit 2	V-ketting	4,50	4,50	2,00
Circuit 3	V-ketting	2,50	4,00	1,40
Circuit 4	V-ketting	2,50	4,00	1,40
Bliksemdraad 1	Vast (Bliksemdraad)	0,10	0,20	0,10
Bliksemdraad 2	Vast (Bliksemdraad)	0,10	0,20	0,10

1. Eigenschappen gelden voor geheel van de isolatorset

Ophanghoogte en positie in mast

Circuits	Aanduiding	Nummer	Ophanghoogte	Aangrippunt	Positie in mast Horizontale afstand
Circuit 1	10	380ct1f1	40,4 m	44,9 m	11,0 m
Circuit 1	11	380ct1f2	49,9 m	54,4 m	14,0 m
Circuit 1	12	380ct1f3	59,9 m	64,4 m	10,6 m
Circuit 2	20	380ct2f1	40,4 m	44,9 m	-11,0 m
Circuit 2	21	380ct2f2	49,9 m	54,4 m	-14,0 m
Circuit 2	22	380ct2f3	59,9 m	64,4 m	-10,6 m
Circuit 3	30	150ct3f1	40,9 m	44,9 m	4,7 m
Circuit 3	31	150ct3f2	50,4 m	54,4 m	7,6 m
Circuit 3	32	150ct3f3	60,4 m	64,4 m	4,3 m
Circuit 4	40	150ct4f1	40,9 m	44,9 m	-4,7 m
Circuit 4	41	150ct4f2	50,4 m	54,4 m	-7,6 m
Circuit 4	42	150ct4f3	60,4 m	64,4 m	-4,3 m
Bliksemdraad 1	1	bl1	65,7 m	65,9 m	16,0 m
Bliksemdraad 2	3	bl2	65,7 m	65,9 m	-16,0 m

Project: RLL-TLB380
 Tower: S+12_c
 Number: 1077

Hoogteaanpassing naastgelegen masten (aanpassing wind- en weight span)

	Back	Ahead	
Verhoging voor windbelasting	0,0 m	0,0 m	(positief: omhoog)
Verlaging voor verticale belasting	-12,0 m	-12,0 m	(negatief: omlaag, grotere weight span)
Verlaging:	Niet in 0,9EG-combinaties		

Hoogteafwijking mastbeeld naastgelegen masten en richtingsverandering t.o.v. Lijnrichting

Circuits	Aanduiding	Nummer	Hoogteverschil		Richtingsverandering	
			Δh_{back}	Δh_{ahead}	Δy_{back}	Δy_{ahead}
Circuit 1	10	380ct1f1	0,0	0,0 m	0,0	0,0 m
Circuit 1	11	380ct1f2	0,0	0,0 m	0,0	0,0 m
Circuit 1	12	380ct1f3	0,0	0,0 m	0,0	0,0 m
Circuit 2	20	380ct2f1	0,0	0,0 m	0,0	0,0 m
Circuit 2	21	380ct2f2	0,0	0,0 m	0,0	0,0 m
Circuit 2	22	380ct2f3	0,0	0,0 m	0,0	0,0 m
Circuit 3	30	150ct3f1	0,0	0,0 m	0,0	0,0 m
Circuit 3	31	150ct3f2	0,0	0,0 m	0,0	0,0 m
Circuit 3	32	150ct3f3	0,0	0,0 m	0,0	0,0 m
Circuit 4	40	150ct4f1	0,0	0,0 m	0,0	0,0 m
Circuit 4	41	150ct4f2	0,0	0,0 m	0,0	0,0 m
Circuit 4	42	150ct4f3	0,0	0,0 m	0,0	0,0 m
Bliksemdraad 1	1	bl1	0,0	0,0 m	0,0	0,0 m
Bliksemdraad 2	3	bl2	0,0	0,0 m	0,0	0,0 m

Lijn- en mastgegevens

	Back	Ahead
Ruling span $\sqrt{(\Sigma L^3/\Sigma L)}$	400,0	400,0 m
Lijnhoek	180 °	
Rotatie mast t.o.v. bissectrice	θ	0 °
Vaklengte	800	800 m
Hoogte onderkant mast t.o.v. maaiveld	0,5 m	
Beschouwde windrichtingen	α_1	0 °
Windrichtingen volgens:	α_2	45 °
<i>Geleiderbelastingen</i>	α_3	90 °
	α_4	135 °
	α_5	- °
	α_6	- °

Windrichtingen gelden t.o.v. hoofdrichting mastconstructie, niet t.o.v. bissectrice.

Windrichtingen en positieve richtingen belastingen

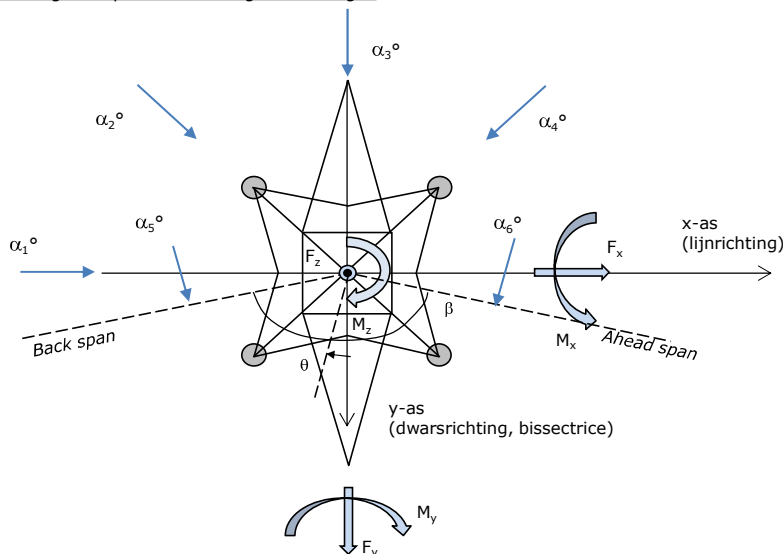

Beschouwd aantal windrichtingen	
1a	4
3	4
4	1
6	1
Overig	1

Project: RLL-TLB380
 Tower: S+12_c
 Number: 1077

Geleiderafval

		SPLS - torsie		SPLS - Enkelzijdige trek		5a - geleiderbreuk	
		Aanw.	Afw.	Aanw.	Afw.	Aanw.	Afw.
Circuit 1	380ct1f1	1	0	1	0	0,8	0
Circuit 1	380ct1f2	1	0	1	0	0,8	0
Circuit 1	380ct1f3	1	0	1	0	0,8	0
Circuit 2	380ct2f1	0	1	1	0	0,8	0
Circuit 2	380ct2f2	0	1	1	0	0,8	0
Circuit 2	380ct2f3	0	1	1	0	0,8	0
Circuit 3	150ct3f1	1	0	1	0	0,8	0
Circuit 3	150ct3f2	1	0	1	0	0,8	0
Circuit 3	150ct3f3	1	0	1	0	0,8	0
Circuit 4	150ct4f1	0	1	1	0	0,8	0
Circuit 4	150ct4f2	0	1	1	0	0,8	0
Circuit 4	150ct4f3	0	1	1	0	0,8	0
Bliksemdraad 1	b1	1	0	1	0	1	0
Bliksemdraad 2	b2	0	1	1	0	1	0

Belastingsituaties SPLS

Beschouwde situaties SPLS: SPLS voor steunmast niet van toepassing

Principe belastingssituaties:

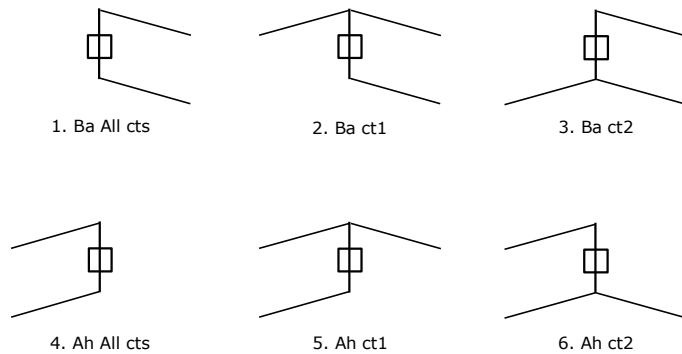

Belastingsituaties 5a. Geleiderbreuk

Beschouwde situaties geleiderbreuk 5a: 1 en 2, alle mogelijke situaties.

Principe belastingssituaties:

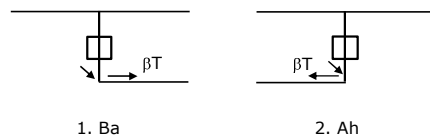

Project: RLL-TLB380
 Tower: S+12_c
 Number: 1077

Belastingsituaties 6. Bouw- en onderhoud

Onder 6a wordt de belasting door aanwezigheid lijnwagen of lijnfiets in combinatie met puntlast op traverse in rekening gebracht. Combinatie 6b bevat geen belastingen in geleider of op traverse. Deze combinatie is toegevoegd om te kunnen combineren met separate controle bordessen etc. De situaties worden in ULS en in iedere SPLS-situatie (in geval van hoekmast) toegepast.

	Fase	Bliksem
Lijnwagen	4,0 kN	2,0 kN
Puntlast op traverse	1,0 kN	1,0 kN

Beschouwde situaties bouw- en onderhoud 6a: 1 t/m 4, alle mogelijke situaties.

Aanwezigheid lijnwagen: Circuit, belasting tegelijk aanwezig in alle geleiders per circuit.

Principe belastingssituaties:

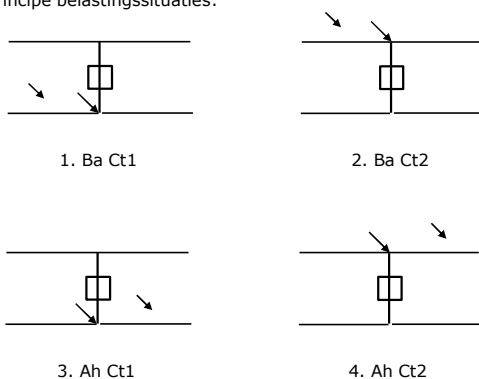

Belastingsituaties 8. Lijndansen als statische belasting

Geleider		
Steunmast fase	0,866 W	1,5 W
Steunmast bliksem	1,5 EDS	1,5 W
Hoekmast fase en bliksem	1,5 EDS	1,5 W

Considered situations galloping 8: 1 and 2, all possible situations

Belasting tegelijk aanwezig in alle geleiders van het circuit.

Principe belastingssituaties:

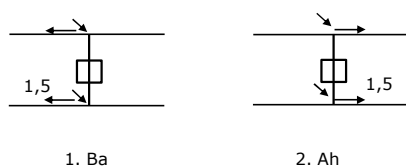

Belastingcombinatie 8. Lijndansen als dynamische belasting

Alleen van toepassing op hoek- en eindmasten

Belasting bestaat uit EDS-trekbelasting in één van de geleiders aan één zijde van de mast

Door gebruiker via het belastingsspectrum van tabel 4.11/NL.1 om te zetten naar spanningspectrum

Project: RLL-TLB380
 Tower: S+12_c
 Number: 1077

Mastconstructie

Eigenschappen

Masttype	Steunmast	
Mastbenaming	S+12_c	
Voetplaat t.o.v. maaiveld	0,5 m	
Masthoogte t.o.v. voetplaat	68,7 m	
Gewicht mast	581,0 kN	
<i>Breedte en helling mast bij fundatie</i>	x-ri.	y-ri.
Pootsprei	12,94	12,94 m
Helling van de randstijl	0,150	0,150 -
Factor spatkracht	1,1	1,1 -

Berekening windbelasting

Dynamische invloed G_T	1,00 (<i>Masthoogte < 60 m</i>)
Windbelasting overhoeks op mastlichaam evenredig met:	$(A1C1\sin^2(\phi)+A2C2\cos^2(\phi))$
Windbelasting overhoeks op traverse evenredig met:	$(A1C1\sin^2(\phi)+A2C2\cos^2(\phi))$
Vergroting wind overhoeks mastlichaam	$(1+0,2\sin^2(2\phi))$
Vergroting wind overhoeks traverse	$(1+0,2\sin^2(2\phi))$
Factor wind evenwijdig t.o.v. haaks op traverse	0,4

Eigenschappen mastsecties langsrichting (vooraanzicht, yz-vlak)

Omschrijving	h [m]	b ₁ [m]	b ₂ [m]	Δh [m]	Δ _x [m]	A ₀ [m ²]	A ₁ [m ²]	χ = A ₁ /A ₀ [-]	C _t
Broekstuk	23,40	12,94	5,92	23,40	0,150	220,71	32,90	0,15	3,16
Eerste tussenstuk	36,10	5,92	4,55	12,70	0,054	66,50	14,15	0,21	2,88
Tweede tussenstuk	44,90	4,55	3,60	8,80	0,054	35,86	10,13	0,28	2,60
Bovenstuk 1	54,40	3,60	2,92	9,50	0,036	30,97	8,66	0,28	2,61
Bovenstuk 2	67,00	2,92	2,01	12,60	0,036	31,06	9,61	0,31	2,50
Topstuk	68,70	2,01		1,70		1,71	0,32	0,18	3,00
Ondertraverse	44,90	12,70		3,00		19,05	4,75	0,25	2,72
Middentraverse	54,40	16,34		3,00		24,51	6,81	0,28	2,62
Boventraverse	64,40	13,70	1,00	2,60		24,66	6,19	0,25	2,72

Eigenschappen mastsecties dwarsrichting (zijaanzicht, xz-vlak)

Omschrijving	h [m]	b ₁ [m]	b ₂ [m]	Δh [m]	Δ _x [m]	A ₀ [m ²]	A ₁ [m ²]	χ = A ₁ /A ₀ [-]	C _t
Broekstuk	23,40	12,94	5,92	23,40	0,150	220,71	32,90	0,15	3,16
Eerste tussenstuk	36,10	5,92	4,55	12,70	0,054	66,50	14,15	0,21	2,88
Tweede tussenstuk	44,90	4,55	3,60	8,80	0,054	35,86	10,13	0,28	2,60
Bovenstuk 1	54,40	3,60	2,92	9,50	0,036	30,97	8,66	0,28	2,61
Bovenstuk 2	67,00	2,92	2,01	12,60	0,036	31,06	9,61	0,31	2,50
Topstuk	68,70	2,01		1,70		1,71	0,32	0,18	3,00
Ondertraverse	44,90	12,70		3,00		19,05	4,75	0,25	2,72
Middentraverse	54,40	16,34		3,00		24,51	6,81	0,28	2,62
Boventraverse	64,40	13,70	1,00	2,60		24,66	6,19	0,25	2,72

NB: oppervlakte traverse dwarsrichting wordt in berekening gereduceerd.

Project: RLL-TLB380
 Tower: S+12_c
 Number: 1077

Windoppervlak feeders telecominstallaties

Onderdeel	A (m ² /m)	Factor	Δh	A ₁
Broekstuk	0,14	0,71	23,4	2,3
Eerste tussenstuk	0,14	0,71	12,7	1,3
Tweede tussenstuk	0,14	0,71	8,8	0,9
Bovenstuk 1				
Bovenstuk 2				

Invoer antennes

Omschrijving	A (m ²)	h (m)	C _r (m)
Antenne top			
Antenne o.t.	4,7	51,2	1,5

Belastingen mastsectie langsrichting (x-richting) per windrichting

Omschrijving	P _w [kN/m ²]	F _{x1} [kN]	F _{x2} [kN]	F _{x3} [kN]	F _{x4} [kN]	h _{ef} [m]	M _{y1} [kNm]	M _{y2} [kNm]	M _{y3} [kNm]	M _{y4} [kNm]
Broekstuk	0,74	77,0	65,3	0,0	-65,3	11,7	900,5	764,1	0,0	-764,1
Eerste tussenstuk	0,99	40,1	34,0	0,0	-34,0	29,8	1193,4	1012,7	0,0	-1012,7
Tweede tussenstuk	1,07	28,3	24,0	0,0	-24,0	40,5	1144,4	971,1	0,0	-971,1
Bovenstuk 1	1,14	25,7	21,8	0,0	-21,8	49,7	1274,5	1081,4	0,0	-1081,4
Bovenstuk 2	1,19	28,7	24,4	0,0	-24,4	60,7	1742,1	1478,2	0,0	-1478,2
Topstuk	1,23	1,2	1,0	0,0	-1,0	67,9	78,9	66,9	0,0	-66,9
Ondertraverse	1,11	28,8	17,1	0,0	-17,1	45,9	1319,8	783,9	0,0	-783,9
Middentraverse	1,17	41,5	24,7	0,0	-24,7	55,4	2301,6	1367,1	0,0	-1367,1
Boventraverse	1,22	40,9	24,3	0,0	-24,3	65,3	2670,3	1586,1	0,0	-1586,1
Totaal		312,1	236,5	0,0	-236,5		12625,4	9111,5	0,0	-9111,5

Belastingen mastsectie dwarsrichting (y-richting) per windrichting

Omschrijving	P _w [kN/m ²]	F _{y1} [kN]	F _{y2} [kN]	F _{y3} [kN]	F _{y4} [kN]	h _{ef} [m]	M _{x1} [kNm]	M _{x2} [kNm]	M _{x3} [kNm]	M _{x4} [kNm]
Broekstuk	0,74	0,0	65,3	77,0	65,3	11,7	0,0	764,1	900,5	764,1
Eerste tussenstuk	0,99	0,0	34,0	40,1	34,0	29,8	0,0	1012,7	1193,4	1012,7
Tweede tussenstuk	1,07	0,0	24,0	28,3	24,0	40,5	0,0	971,1	1144,4	971,1
Bovenstuk 1	1,14	0,0	21,8	25,7	21,8	49,7	0,0	1081,4	1274,5	1081,4
Bovenstuk 2	1,19	0,0	24,4	28,7	24,4	60,7	0,0	1478,2	1742,1	1478,2
Topstuk	1,23	0,0	1,0	1,2	1,0	67,9	0,0	66,9	78,9	66,9
Ondertraverse	1,11	0,0	17,1	11,5	17,1	45,9	0,0	783,9	527,9	783,9
Middentraverse	1,17	0,0	24,7	16,6	24,7	55,4	0,0	1367,1	920,6	1367,1
Boventraverse	1,22	0,0	24,3	16,4	24,3	65,3	0,0	1586,1	1068,1	1586,1
Totaal		0,0	236,5	245,4	236,5		0,0	9111,5	8850,5	9111,5

Resulterende belastingen vanuit mastconstructie incl. antenne zonder geleiders niveau fundatie (kar. waarde)

Belasting / windrichting	F _x [kN]	F _y [kN]	F _z [kN]	M _x [kNm]	M _y [kNm]	M _z [kNm]
Permanente belasting	0	0	581	0	0	0
Windrichting 0°	320	0	0	0	13038	0
Windrichting 45°	242	242	0	9403	9403	0
Windrichting 90°	0	253	0	9263	0	0
Windrichting 135°	-242	242	0	9403	-9403	0

Project: RLL-TLB380
 Tower: S+12_c
 Number: 1077

Tussenresultaten geleiderbelastingen

Geleiders back

Circuit	Geleider	Diameter [mm]	A [mm ²]	G [N/m]	E [N/mm ²]	αT [-]
Circuit 1	AAAC-AL7 620	32,4	621,0	17,71	56000	2,30E-05
Circuit 2	AAAC-AL7 620	32,4	621,0	17,71	56000	2,30E-05
Circuit 3	AAAC-AL7 620	32,4	621,0	17,71	56000	2,30E-05
Circuit 4	AAAC-AL7 620	32,4	621,0	17,71	56000	2,30E-05
Bliksemdraad 1	AACSR 241-AL3-39-A20SA	21,8	281,0	9,38	70165	1,97E-05
Bliksemdraad 2	OPGW AFL-226/38	21,7	264,0	9,13	72000	1,98E-05

Geleiders ahead

Circuit	Geleider	Diameter [mm]	A [mm ²]	G [N/m]	E [N/mm ²]	αT [-]
Circuit 1	AAAC-AL7 620	32,4	621,0	17,71	56000	2,30E-05
Circuit 2	AAAC-AL7 620	32,4	621,0	17,71	56000	2,30E-05
Circuit 3	AAAC-AL7 620	32,4	621,0	17,71	56000	2,30E-05
Circuit 4	AAAC-AL7 620	32,4	621,0	17,71	56000	2,30E-05
Bliksemdraad 1	AACSR 241-AL3-39-A20SA	21,8	281,0	9,38	70165	1,97E-05
Bliksemdraad 2	OPGW AFL-226/38	21,7	264,0	9,13	72000	1,98E-05

Verticale belasting back

Circuit	Bundel [-]	Toeslag [%]	$w_{z,G}$ [N/m]	IJsg gebied	Formule	$w_{z,ijs}$ [N/m]	$w_{z,ijs,bundel}$ [N/m]
Circuit 1	4	3	73,0	B	4+0,2d	10,5	41,9
Circuit 2	4	3	73,0	B	4+0,2d	10,5	41,9
Circuit 3	2	3	36,5	B	4+0,2d	10,5	21,0
Circuit 4	2	3	36,5	B	4+0,2d	10,5	21,0
Bliksemdraad 1	1	2	9,6	A	15+0,4d	23,7	23,7
Bliksemdraad 2	1	2	9,3	A	15+0,4d	23,7	23,7

Verticale belasting ahead

Circuit	Bundel [-]	Toeslag [%]	$w_{z,G}$ [N/m]	IJsg gebied	Formule	$w_{z,ijs}$ [N/m]	$w_{z,ijs,bundel}$ [N/m]
Circuit 1	4	3	73,0	B	4+0,2d	10,5	41,9
Circuit 2	4	3	73,0	B	4+0,2d	10,5	41,9
Circuit 3	2	3	36,5	B	4+0,2d	10,5	21,0
Circuit 4	2	3	36,5	B	4+0,2d	10,5	21,0
Bliksemdraad 1	1	2	9,6	A	15+0,4d	23,7	23,7
Bliksemdraad 2	1	2	9,3	A	15+0,4d	23,7	23,7

Isolatoren

Geleider	$G_{isolator}$ [kN]	Aantal	$F_{V,iso}$ [kN]	Lengte [m]	Windopp. [m ²]	Windhoogte [m]	Stuwdruk [kN/m ²]	Vormfactor	$F_{th,iso}$ [kN]
380ct1f1	4,50	1	4,5	4,5	2,0	43,15	1,09	1,2	2,62
380ct1f2	4,50	1	4,5	4,5	2,0	52,65	1,15	1,2	2,76
380ct1f3	4,50	1	4,5	4,5	2,0	62,65	1,20	1,2	2,89
380ct2f1	4,50	1	4,5	4,5	2,0	43,15	1,09	1,2	2,62
380ct2f2	4,50	1	4,5	4,5	2,0	52,65	1,15	1,2	2,76
380ct2f3	4,50	1	4,5	4,5	2,0	62,65	1,20	1,2	2,89
150ct3f1	2,50	1	2,5	4,0	1,4	43,40	1,09	1,2	1,84
150ct3f2	2,50	1	2,5	4,0	1,4	52,90	1,15	1,2	1,94
150ct3f3	2,50	1	2,5	4,0	1,4	62,90	1,20	1,2	2,02
150ct4f1	2,50	1	2,5	4,0	1,4	43,40	1,09	1,2	1,84
150ct4f2	2,50	1	2,5	4,0	1,4	52,90	1,15	1,2	1,94
150ct4f3	2,50	1	2,5	4,0	1,4	62,90	1,20	1,2	2,02
bl1	0,10	1	0,1	0,2	0,1	66,30	1,22	1,2	0,15
bl2	0,10	1	0,1	0,2	0,1	66,30	1,22	1,2	0,15

Project: RLL-TLB380
 Tower: S+12_c
 Number: 1077

Windbelasting back

Geleider	hoogte		Stuwdruk [kN/m ²]	G _{c_dwars} [-]	G _{c_trek} [-]	C _c [-]	d _{toeslag} [mm]	W _y [N/m]	W _{y,vak} [N/m]	D _{ijs,toeslag} [mm]	W _{y,ijs} [N/m]	W _{y,ijs,vak} [N/m]
	wind [m]	hoogte										
380ct1f1	33,5		1,02	0,59	0,59	1,00	33,37	79,4	79,4	51,8	148,6	148,6
380ct1f2	43,0		1,09	0,61	0,61	0,97	33,37	85,8	85,8	51,8	164,4	164,4
380ct1f3	53,0		1,15	0,62	0,62	0,95	33,37	91,3	91,3	51,8	178,3	178,3
380ct2f1	33,5		1,02	0,59	0,59	1,00	33,37	79,4	79,4	51,8	148,6	148,6
380ct2f2	43,0		1,09	0,61	0,61	0,97	33,37	85,8	85,8	51,8	164,4	164,4
380ct2f3	53,0		1,15	0,62	0,62	0,95	33,37	91,3	91,3	51,8	178,3	178,3
150ct3f1	34,0		1,02	0,59	0,59	0,99	33,37	39,9	39,9	51,8	74,8	74,8
150ct3f2	43,5		1,09	0,61	0,61	0,97	33,37	43,1	43,1	51,8	82,6	82,6
150ct3f3	53,5		1,16	0,62	0,62	0,95	33,37	45,8	45,8	51,8	89,5	89,5
150ct4f1	34,0		1,02	0,59	0,59	0,99	33,37	39,9	39,9	51,8	74,8	74,8
150ct4f2	43,5		1,09	0,61	0,61	0,97	33,37	43,1	43,1	51,8	82,6	82,6
150ct4f3	53,5		1,16	0,62	0,62	0,95	33,37	45,8	45,8	51,8	89,5	89,5
bl1	58,8		1,18	0,63	0,63	1,18	22,24	19,5	19,5	63,1	56,5	56,5
bl2	58,8		1,18	0,63	0,63	1,18	22,13	19,4	19,4	63,0	56,4	56,4

Windbelasting ahead

Geleider	hoogte		Stuwdruk [kN/m ²]	G _{c_dwars} [-]	G _{c_trek} [-]	C _c [-]	d _{toeslag} [mm]	W _y [N/m]	W _{y,vak} [N/m]	D _{ijs,toeslag} [mm]	W _{y,ijs} [N/m]	W _{y,ijs,vak} [N/m]
	wind [m]	hoogte										
380ct1f1	33,5		1,02	0,59	0,59	1,00	33,37	79,4	79,4	51,8	148,6	148,6
380ct1f2	43,0		1,09	0,61	0,61	0,97	33,37	85,8	85,8	51,8	164,4	164,4
380ct1f3	53,0		1,15	0,62	0,62	0,95	33,37	91,3	91,3	51,8	178,3	178,3
380ct2f1	33,5		1,02	0,59	0,59	1,00	33,37	79,4	79,4	51,8	148,6	148,6
380ct2f2	43,0		1,09	0,61	0,61	0,97	33,37	85,8	85,8	51,8	164,4	164,4
380ct2f3	53,0		1,15	0,62	0,62	0,95	33,37	91,3	91,3	51,8	178,3	178,3
150ct3f1	34,0		1,02	0,59	0,59	0,99	33,37	39,9	39,9	51,8	74,8	74,8
150ct3f2	43,5		1,09	0,61	0,61	0,97	33,37	43,1	43,1	51,8	82,6	82,6
150ct3f3	53,5		1,16	0,62	0,62	0,95	33,37	45,8	45,8	51,8	89,5	89,5
150ct4f1	34,0		1,02	0,59	0,59	0,99	33,37	39,9	39,9	51,8	74,8	74,8
150ct4f2	43,5		1,09	0,61	0,61	0,97	33,37	43,1	43,1	51,8	82,6	82,6
150ct4f3	53,5		1,16	0,62	0,62	0,95	33,37	45,8	45,8	51,8	89,5	89,5
bl1	58,8		1,18	0,63	0,63	1,18	22,24	19,5	19,5	63,1	56,5	56,5
bl2	58,8		1,18	0,63	0,63	1,18	22,13	19,4	19,4	63,0	56,4	56,4

Project: RLL-TLB380
 Masttype: S+12_c
 Mast: 1077

Auteur: TBR
 Versie: v11.8

Geleiderbelastingen

Uitgangspunten

Betrouwbaarheidsniveau Nieuwbouw CC2
 Referentieperiode 50 jaar

ULS (bezwijksterkte)		NEN-EN50341-2-15:2019						
Belastingsgeval	omschrijving	Temp °C	γ_G		γ_Q			γ_a A_k
			$G_{k,mast}$	$G_{k,geleider}$	Q_{pk}	Q_{wk}	Q_{ik}	
ULS 1a	Wind	10°	1,20	1,20	0,00	1,50	0,00	0,0
ULS 1a_0,9	Wind 0,9Gk alleen mast	10°	0,90	1,20	0,00	1,50	0,00	0,0
ULS 1a_0,9_0,9	Wind 0,9Gk ook geleider	10°	0,90	0,90	0,00	1,50	0,00	0,0
ULS 3	Wind+ijs	-5°	1,20	1,20	0,00	0,45	1,50	0,0
ULS 3_0,9	Wind+ijs 0,9	-5°	0,90	1,20	0,00	0,45	1,50	0,0
ULS 4	Koude+wind	-20°	1,20	1,20	0,00	0,30	0,00	0,0
ULS 4_0,9	Koude+wind 0,9	-20°	0,90	1,20	0,00	0,30	0,00	0,0
ULS 5a	Torsiebelastingen	10°	1,00	1,00	1,00	0,00	0,00	1,0
ULS 5b	Longitudinale belastingen	10°	1,00	1,00	0,00	0,00	0,00	1,0
ULS 6	Bouw en onderhoud	5°	1,20	1,20	1,50	0,30	0,00	0,0
ULS 6_0,9	Bouw en onderhoud	5°	1,20	1,20	0,00	0,30	0,00	0,0
ULS 7	Permanent	10°	1,35	1,35	0,00	0,00	0,00	0,0
ULS 8	Special	10°	1,00	1,00	0,00	0,00	0,00	1,0
SPLS (Bezwijksterkte, enkel voor hoekmasten: afwezigheid geleiders)				γ_G	γ_Q			
			G_k	G_k	Q_{pk}	Q_{wk}	Q_{ik}	A_k
SPLS 1a	Wind	10°	1,20	1,20	0,0	0,78	0,00	0,0
SPLS 1a_0,9	Wind 0,9	10°	0,90	1,20	0,0	0,78	0,00	0,0
SPLS 1a_0,9_0,9	Wind 0,9	10°	0,90	0,90	0,0	0,78	0,00	0,0
SPLS 3	Wind+ijs	-5°	1,20	1,20	0,0	0,36	0,34	0,0
SPLS 3_0,9	Wind+ijs 0,9	-5°	0,90	1,20	0,0	0,36	0,34	0,0
SPLS 4	Koude+wind	-20°	1,20	1,20	0,0	0,24	0,00	0,0
SPLS 4_0,9	Koude+wind 0,9	-20°	0,90	1,20	0,0	0,24	0,00	0,0
SPLS 6	Bouw en onderhoud	5°	1,20	1,20	1,2	0,24	0,0	0,0
SPLS 6_0,9	Bouw en onderhoud	5°	1,20	1,20	0,0	0,24	0,0	0,0
SLS (controle van de vervormingen, vermoeiing, EDS)			γ_G		Q_{pk}	Q_{wk}	Q_{ik}	A_k
			G_k	G_k				
SLS 1a	Wind	10°	1,00	1,00	0,0	1,00	0,0	0,0
SLS 3	Wind+ijs	-5°	1,00	1,00	0,0	0,30	1,00	0,0
SLS 4	Wind	-20°	1,00	1,00	0,0	0,20	0,0	0,0
SLS 6	Bouw en onderhoud	5°	1,00	1,00	0,0	0,20	0,0	0,0
SLS 7	PB (EDS, geen wind)	10°	1,00	1,00	0,0	0,00	0,0	0,0

Aantal windrichtingen 4
 Aantal belastingcombinaties ULS 62
 Aantal belastingcombinaties SPLS 0
 Aantal belastingcombinaties SLS 11
 Aantal knooplasten 1022

Project: RLL-TLB380
 Masttype: S+12_c
 Mast: 1077

Samenvattingstabellen geleiderbelastingen

In de onderstaande vier tabellen is weergegeven:

- De maximale geleiderbelasting in het globale assenstelsel, gesplitst in aandeel van back en ahead span
- De gecombineerde geleiderbelasting (Ba+Ah) in het globale assenstelsel met in het lokale assenstelsel de maximaal optredende trekkracht. Componenten Fx en Fy als absolute waarde
- De alledaagse (EDS) waarden van de gecombineerde geleiderbelastingen (Ba+Ah) met bijbehorende trekkrachten
- Controle op uplift, waar een negatieve waarde duidt op uplift

Maximale waarden voor back en ahead span

Geleider	Fx_ba [kN]	Fx_ah [kN]	Fy_ba [kN]	Fy_ah [kN]	Fz_ba [kN]	Fz_ah [kN]
bl1	-66,8	66,8	6,0	6,0	11,5	11,5
380ct1f1	-261,3	261,3	25,8	25,8	40,6	40,6
380ct1f2	-264,8	264,8	27,8	27,8	40,7	40,7
380ct1f3	-268,1	268,1	29,6	29,6	40,8	40,8
380ct2f1	-261,3	261,3	25,8	25,8	40,6	40,6
380ct2f2	-264,8	264,8	27,8	27,8	40,7	40,7
380ct2f3	-268,1	268,1	29,6	29,6	40,8	40,8
150ct3f1	-130,7	130,7	13,3	13,3	20,5	20,5
150ct3f2	-132,5	132,5	14,4	14,4	20,5	20,5
150ct3f3	-134,1	134,1	15,2	15,2	20,6	20,6
150ct4f1	-130,7	130,7	13,3	13,3	20,5	20,5
150ct4f2	-132,5	132,5	14,4	14,4	20,5	20,5
150ct4f3	-134,1	134,1	15,2	15,2	20,6	20,6
bl2	-65,8	65,8	5,9	5,9	11,4	11,4

Min. Weight span (m)

Weight spar Combinatie1

Geleider	SLS 1a	SLS 4	SLS 7
bl1	508,0	530,3	508,0
380ct1f1	508,0	527,7	508,0
380ct1f2	508,0	528,1	508,0
380ct1f3	508,0	528,4	508,0
380ct2f1	508,0	527,7	508,0
380ct2f2	508,0	528,1	508,0
380ct2f3	508,0	528,4	508,0
150ct3f1	508,0	527,8	508,0
150ct3f2	508,0	528,1	508,0
150ct3f3	508,0	528,4	508,0
150ct4f1	508,0	527,8	508,0
150ct4f2	508,0	528,1	508,0
150ct4f3	508,0	528,4	508,0
bl2	508,0	530,7	508,0

Max. Weight span (m)

Weight spar Combinatie1

Geleider	ULS 1a	ULS 3
bl1	629,6	485,1
380ct1f1	557,3	504,2
380ct1f2	563,7	505,6
380ct1f3	569,2	506,9
380ct2f1	557,3	504,2
380ct2f2	563,7	505,6
380ct2f3	569,2	506,9
150ct3f1	557,7	504,3
150ct3f2	564,0	505,7
150ct3f3	569,5	507,0
150ct4f1	557,7	504,3
150ct4f2	564,0	505,7
150ct4f3	569,5	507,0
bl2	632,9	484,6

Omhullende weight span over alle combinaties (incl. 0,9 combinaties)

Voor alle geleiders

Max. weight span	632,9 m
Min. weight span	400,0 m

Wind / Weight span verhouding

	1,582 -
	1,000 -

Project: RLL-TLB380
 Masttype: S+12_c
 Mast: 1077

Maximale waarden back+ahead span Maximale waarden trekkracht geleider

Geleider	Fx	Fy	Fz	Ft_ba	Ft_ah
	[kN]	[kN]	[kN]	[kN]	[kN]
bl1	25,8	11,9	22,9	-66,8	66,8
380ct1f1	105,1	51,6	81,3	-261,3	261,3
380ct1f2	105,1	55,6	81,5	-264,8	264,8
380ct1f3	105,1	59,1	81,7	-268,1	268,1
380ct2f1	105,1	51,6	81,3	-261,3	261,3
380ct2f2	105,1	55,6	81,5	-264,8	264,8
380ct2f3	105,1	59,1	81,7	-268,1	268,1
150ct3f1	52,5	26,7	40,9	-130,7	130,7
150ct3f2	52,5	28,7	41,0	-132,5	132,5
150ct3f3	52,5	30,5	41,1	-134,1	134,1
150ct4f1	52,5	26,7	40,9	-130,7	130,7
150ct4f2	52,5	28,7	41,0	-132,5	132,5
150ct4f3	52,5	30,5	41,1	-134,1	134,1
bl2	25,1	11,9	22,7	-65,8	65,8

EDS-belastingen geleiders

Geleider	Fx	Fy	Fz	Ft_ba	Ft_ah
	[kN]	[kN]	[kN]	[kN]	[kN]
bl1	0,0	0,0	5,0	-17,2	17,2
380ct1f1	0,0	0,0	41,6	-131,3	131,3
380ct1f2	0,0	0,0	41,6	-131,3	131,3
380ct1f3	0,0	0,0	41,6	-131,3	131,3
380ct2f1	0,0	0,0	41,6	-131,3	131,3
380ct2f2	0,0	0,0	41,6	-131,3	131,3
380ct2f3	0,0	0,0	41,6	-131,3	131,3
150ct3f1	0,0	0,0	21,0	-65,7	65,7
150ct3f2	0,0	0,0	21,0	-65,7	65,7
150ct3f3	0,0	0,0	21,0	-65,7	65,7
150ct4f1	0,0	0,0	21,0	-65,7	65,7
150ct4f2	0,0	0,0	21,0	-65,7	65,7
150ct4f3	0,0	0,0	21,0	-65,7	65,7
bl2	0,0	0,0	4,8	-16,8	16,8

Controle uplift SLS-wind

Combinatie: Geleider	Fz_ba	Fz_ah
	[kN]	[kN]
SLS 4		
bl1	2,6	2,6
380ct1f1	21,5	21,5
380ct1f2	21,5	21,5
380ct1f3	21,5	21,5
380ct2f1	21,5	21,5
380ct2f2	21,5	21,5
380ct2f3	21,5	21,5
150ct3f1	10,9	10,9
150ct3f2	10,9	10,9
150ct3f3	10,9	10,9
150ct4f1	10,9	10,9
150ct4f2	10,9	10,9
150ct4f3	10,9	10,9
bl2	2,5	2,5

Project: RLL-TLB380
 Masttype: S+12_c
 Mast: 1077

ULS-fundatiebelasting combinatie 1 en 3 wind haaks op de lijn of bissectrice en EDS, vanuit geleiders

Combinatie	Combination	F_x [kN]	F_y [kN]	F_z [kN]	M_x [kNm]	M_y [kNm]	M_z [kNm]
ULS 1a_90		0	528	509	29322	0	0
ULS 1a_0,9_90		0	528	375	29321	0	0
ULS 3_90		0	299	781	16703	0	0
ULS 3_0,9_90		0	299	630	16702	0	0
SLS 7		0	0	385	2	0	0

ULS-fundatiebelasting combinatie 1 en 3 wind haaks op de lijn of bissectrice en EDS, totaal geleiders en mast

Combinatie	F_x [kN]	F_y [kN]	F_z [kN]	M_x [kNm]	M_y [kNm]	M_z [kNm]
ULS 1a_90	0	908	1206	43216	0	0
ULS 3_90	0	413	1478	20871	0	0
SLS 7	0	0	966	2	0	0

Fundatiebelastingen, selectie belastingcombinaties op basis grootste waarde

Combinatie	F_x [kN]	F_y [kN]	F_z [kN]	M_x [kNm]	M_y [kNm]	M_z [kNm]
ULS 1a_90	0	908	1206	43216	0	0
ULS 1a_0	502	0	1157	2	20744	0
ULS 5a Ba 11	105	0	962	-257	5716	1471
ULS 1a_45	379	636	1173	29253	14944	0

Noot: grootste waarden kunnen in meerdere combinaties voorkomen, een combinatie is weergegeven.

Oplegreacties op fundering per randstijl

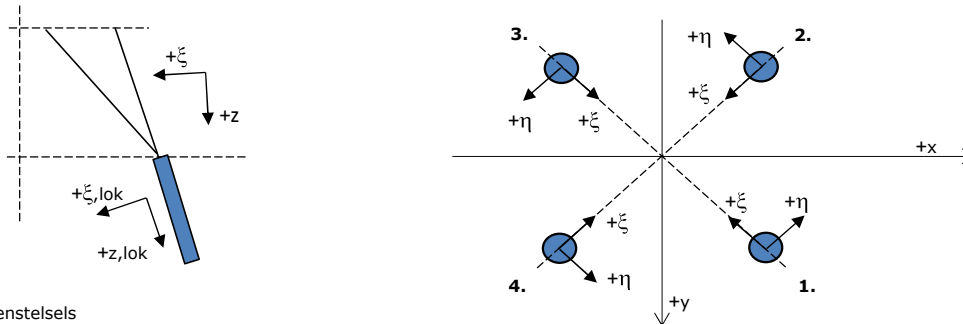

Assenstelsels

Maximale drukbelasting

Stijl	Combinatie	R_x [kN]	R_y [kN]	R_z [kN]	R_η [kN]	R_ξ [kN]	$R_{\xi,lok}$ [kN]	$R_{z,lok}$ [kN]
1	ULS 1a_45	329	303	2001	19	-447	-23	2045
2	ULS 1a_0	173	-180	1090	5	-250	-18	1115
3	ULS 8 Ba	-132	-169	1023	-26	-213	4	1046
4	ULS 1a_135	-329	303	2001	-19	-447	-23	2045

Maximale trekbelasting

Stijl	Combinatie	R_x [kN]	R_y [kN]	R_z [kN]	R_η [kN]	R_ξ [kN]	$R_{\xi,lok}$ [kN]	$R_{z,lok}$ [kN]
1	ULS 8 Ba	-38	-75	-454	26	80	-16	-464
2	ULS 1a_0,9_0,9_135	-248	221	-1506	19	332	12	-1540
3	ULS 1a_0,9_0,9_45	248	221	-1506	-19	332	12	-1540
4	ULS 1a_0,9_0,9_0	92	-99	-600	-5	135	8	-614

Maximale torsiebelasting (positief)

Stijl	Combinatie	R_x [kN]	R_y [kN]	R_z [kN]	R_η [kN]	R_ξ [kN]	$R_{\xi,lok}$ [kN]	$R_{z,lok}$ [kN]
1	ULS 5a Ah 21	43	-25	30	49	-13	-7	30
2	ULS 5a Ba 11	39	-105	471	46	-102	-2	482
3	ULS 5a Ba 11	-43	25	30	49	-13	-7	30
4	ULS 5a Ah 21	-39	105	471	46	-102	-2	482

Maximale torsiebelasting (negatief)

Stijl	Combinatie	R_x [kN]	R_y [kN]	R_z [kN]	R_η [kN]	R_ξ [kN]	$R_{\xi,lok}$ [kN]	$R_{z,lok}$ [kN]
1	ULS 5a Ba 21	39	105	471	-46	-102	-2	482
2	ULS 5a Ah 11	43	25	30	-49	-13	-7	30
3	ULS 5a Ah 11	-39	-105	471	-46	-102	-2	482
4	ULS 5a Ba 21	-43	-25	30	-49	-13	-7	30

Project: RLL-TLB380
 Masttype: S+12_c
 Mast: 1077

Combinatie Ftrek+Fhor

Stijl	Combinatie	R _x [kN]	R _y [kN]	R _z [kN]	R _η [kN]	R _ξ [kN]	R _{ξ,lok} [kN]	R _{z,lok} [kN]
1	ULS 8 Ba	-38	-75	-454	26	80	-16	-464
2	ULS 1a_0,9_0,9_90	-242	194	-1469	34	308	-3	-1501
3	ULS 1a_0,9_0,9_90	242	194	-1469	-34	308	-3	-1501
4	ULS 1a_0,9_0,9_0	92	-99	-600	-5	135	8	-614

Permanente belasting

Stijl	Combinatie	R _x [kN]	R _y [kN]	R _z [kN]	R _η [kN]	R _ξ [kN]	R _{ξ,lok} [kN]	R _{z,lok} [kN]
1	SLS 7	40	40	242	0	-56	-5	247
2	SLS 7	40	-40	242	0	-56	-5	247
3	SLS 7	-40	-40	242	0	-56	-5	247
4	SLS 7	-40	40	242	0	-56	-5	247

Omhullenden ongeacht stijl

Belasting	Combinatie	R _x [kN]	R _y [kN]	R _z [kN]	R _η [kN]	R _ξ [kN]	R _{ξ,lok} [kN]	R _{z,lok} [kN]
Max. druk	ULS 1a_45	329	303	2001	19	-447	-23	2045
Max. trek	ULS 1a_0,9_0,9_45	248	221	-1506	-19	332	12	-1540
Max. pos. torsie	ULS 5a Ah 21	43	-25	30	49	-13	-7	30
Max. neg. torsie	ULS 5a Ba 21	-43	-25	30	-49	-13	-7	30
Comb. trek+torsie	ULS 1a_0,9_0,9_90	-242	194	-1469	34	308	-3	-1501

Maximale trekbelasting SLS

Stijl	Combinatie	R _x [kN]	R _y [kN]	R _z [kN]	R _η [kN]	R _ξ [kN]	R _{ξ,lok} [kN]	R _{z,lok} [kN]
1	SLS 7	40	40	242	0	-56	-5	247
2	SLS 1a_135	-147	129	-894	13	195	6	-914
3	SLS 1a_45	147	129	-894	-13	195	6	-914
4	SLS 1a_0	44	-48	-293	-3	65	3	-299

Maximale drukbelasting SLS

Stijl	Combinatie	R _x [kN]	R _y [kN]	R _z [kN]	R _η [kN]	R _ξ [kN]	R _{ξ,lok} [kN]	R _{z,lok} [kN]
1	SLS 1a_45	228	210	1382	13	-309	-16	1413
2	SLS 1a_0	123	-128	776	3	-178	-13	793
3	SLS 7	-40	-40	242	0	-56	-5	247
4	SLS 1a_135	-228	210	1382	-13	-309	-16	1413

Project: RLL-TLB380
Masttype: S+12_c
Mast: 1077

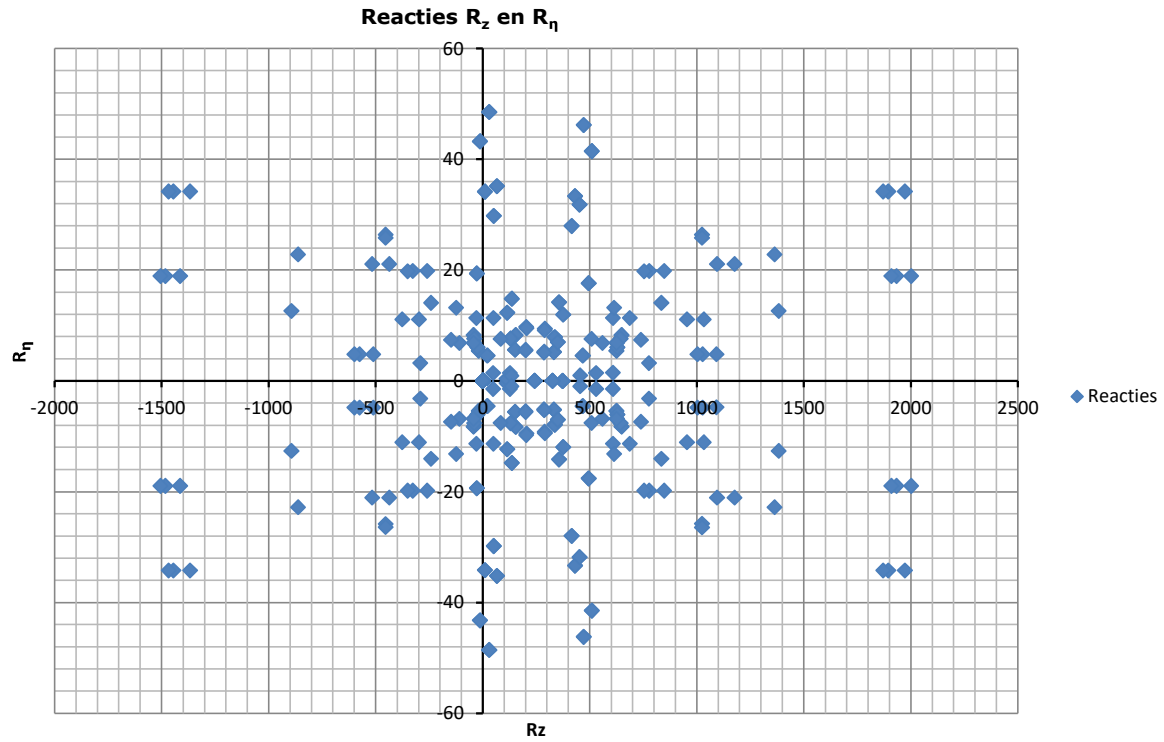

Project: RLL-TLB380
 Tower: S+12_c - bouwfase
 Number: 1077

Auteur: TBR
 Versie: v11.8

Geleiderbelastingen

Algemeen

Benaming S+12_c - bouwfase
 Masttype Steunmast
 Aantal circuits 2
 Configuratie 2-circuit-verticaal
 Aantal bliksemgeleiders 1

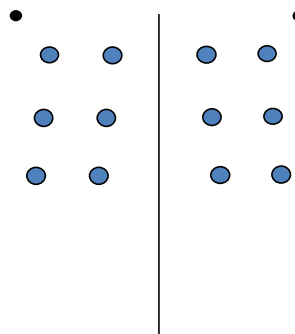

Configuratie geleiders

Uitgangspunten

Norm NEN-EN50341-2-15:2019
 Gevolgklasse initieel CC2
 Betrouwbaarheidsniveau initieel Nieuwbouw
 Referentieperiode initieel 15 jaar
 Referentieperiode na aanpassing CC2
 Betrouwbaarheidsniveau na aanpassing n.v.t.
 Betrouwbaarheidsniveau na aanpassing 50 jaar
 Windgebied III
 Windsnelheid (m/s) 24,5 m/s
 Terreincategorie II
 Reductiefactor c_{dir} 1,00
 IJsg gebied fasegeleider B
 IJsg gebied bliksemgeleider A

Geleiders Back

Omschrijving	Spanning	Geleider Back	Bundel Ba	IJsg gebied	Toeslag gewicht	Toeslag diameter	Intrekwaarden P_{back}
Circuit 1	380 kV	AAAC-AL7 620	4	B	3 %	3 %	1800
Circuit 2	150 kV	AAAC-AL7 620	2	B	3 %	3 %	1800
Bliksemdraad 1		AACSR 241-AL3-39-A20SA	1	A	2 %	2 %	1800

Geleiders Ahead

Omschrijving	Spanning	Geleider Ahead	Bundel Ah	IJsg gebied	Toeslag gewicht	Toeslag diameter	Intrekwaarden P_{ahead}
Circuit 1	380 kV	AAAC-AL7 620	4	B	3 %	3 %	1800
Circuit 2	150 kV	AAAC-AL7 620	2	B	3 %	3 %	1800
Bliksemdraad 1		AACSR 241-AL3-39-A20SA	1	A	2 %	2 %	1800

Isolatoren (1)

Omschrijving	Ophanging	Gewicht [kN]	Lengte [m]	Windopp. [m ²]
Circuit 1	V-ketting	4,50	4,50	2,00
Circuit 2	V-ketting	2,50	4,00	1,40
Bliksemdraad 1	Vast (Bliksemdraad)	0,10	0,20	0,10

1. Eigenschappen gelden voor geheel van de isolatorset

Ophanghoogte en positie in mast

Circuits	Aanduiding	Nummer	Ophanghoogte	Aangrippunt	Positie in mast Horizontale afstand
Circuit 1	10	380ct1f1	40,4 m	44,9 m	11,0 m
Circuit 1	11	380ct1f2	49,9 m	54,4 m	14,0 m
Circuit 1	12	380ct1f3	59,9 m	64,4 m	10,6 m
Circuit 2	20	150ct2f1	40,9 m	44,9 m	4,7 m
Circuit 2	21	150ct2f2	50,4 m	54,4 m	7,6 m
Circuit 2	22	150ct2f3	60,4 m	64,4 m	4,3 m
Bliksemdraad 1	1	bl1	65,7 m	65,9 m	-16,0 m

Project: RLL-TLB380
 Tower: S+12_c - bouwfase
 Number: 1077

Hoogteaanpassing naastgelegen masten (aanpassing wind- en weight span)

	Back	Ahead	
Verhoging voor windbelasting	0,0 m	0,0 m	(positief: omhoog)
Verlaging voor verticale belasting	-12,0 m	-12,0 m	(negatief: omlaag, grotere weight span)
Verlaging:	Niet in 0,9EG-combinaties		

Hoogteafwijking mastbeeld naastgelegen masten en richtingsverandering t.o.v. Lijnrichting

Circuits	Aanduiding	Nummer	Hoogteverschil		Richtingsverandering	
			Δh_{back}	Δh_{ahead}	Δy_{back}	Δy_{ahead}
Circuit 1	10	380ct1f1	0,0	0,0 m	0,0	0,0 m
Circuit 1	11	380ct1f2	0,0	0,0 m	0,0	0,0 m
Circuit 1	12	380ct1f3	0,0	0,0 m	0,0	0,0 m
Circuit 2	20	150ct2f1	0,0	0,0 m	0,0	0,0 m
Circuit 2	21	150ct2f2	0,0	0,0 m	0,0	0,0 m
Circuit 2	22	150ct2f3	0,0	0,0 m	0,0	0,0 m
Bliksemendraad 1	1	bl1	0,0	0,0 m	0,0	0,0 m

Lijn- en mastgegevens

	Back	Ahead
Ruling span $\sqrt{(\Sigma L^3/\Sigma L)}$	400,0	400,0 m
Lijnhoek	β	180 °
Rotatie mast t.o.v. bissectrice	θ	0 °
Vaklengte	800	800 m
Hoogte onderkant mast t.o.v. maaiveld	0,5 m	
Beschouwde windrichtingen	α_1	0 °
Windrichtingen volgens:	α_2	45 °
<i>Geleiderbelastingen</i>	α_3	90 °
	α_4	135 °
	α_5	225 °
	α_6	270 °

Windrichtingen gelden t.o.v. hoofdrichting mastconstructie, niet t.o.v. bissectrice.

Windrichtingen en positieve richtingen belastingen

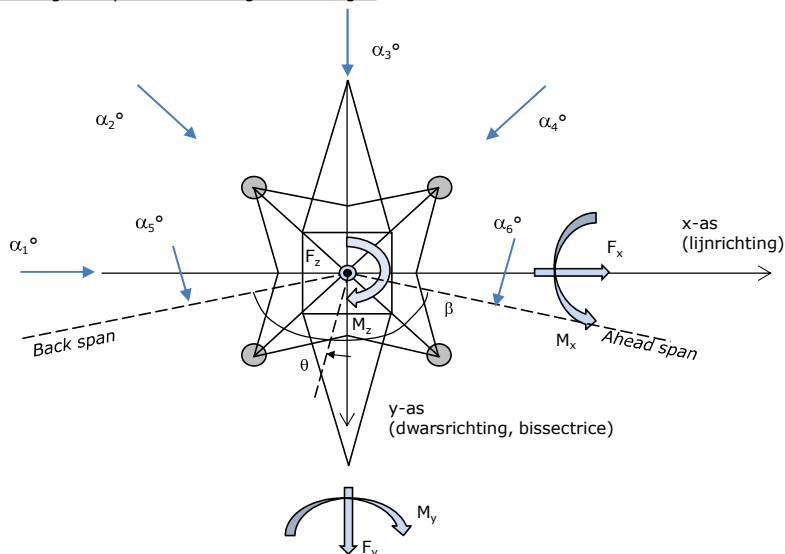

Beschouwd aantal windrichtingen	
1a	6
3	6
4	1
6	1
Overig	1

Project: RLL-TLB380
 Tower: S+12_c - bouwfase
 Number: 1077

Geleiderafval

		SPLS - torsie		SPLS - Enkelzijdige trek		5a - geleiderbreuk	
		Aanw.	Afw.	Aanw.	Afw.	Aanw.	Afw.
Circuit 1	380ct1f1	1	0	1	0	0,8	0
Circuit 1	380ct1f2	1	0	1	0	0,8	0
Circuit 1	380ct1f3	1	0	1	0	0,8	0
Circuit 2	150ct2f1	0	1	1	0	0,8	0
Circuit 2	150ct2f2	0	1	1	0	0,8	0
Circuit 2	150ct2f3	0	1	1	0	0,8	0
Bliksemdraad 1	bl1	1	0	1	0	1	0

Belastingsituaties SPLS

Beschouwde situaties SPLS: SPLS voor steunmast niet van toepassing

Principe belastingssituaties:

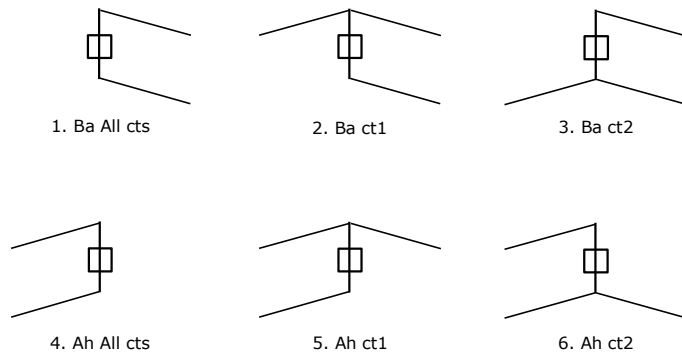

Belastingsituaties 5a. Geleiderbreuk

Beschouwde situaties geleiderbreuk 5a: 1 en 2, alle mogelijke situaties.

Principe belastingssituaties:

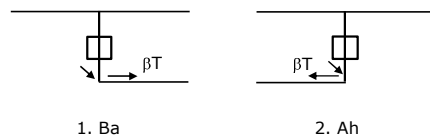

Project: RLL-TLB380
 Tower: S+12_c - bouwfase
 Number: 1077

Belastingsituaties 6. Bouw- en onderhoud

Onder 6a wordt de belasting door aanwezigheid lijnwagen of lijnfiets in combinatie met puntlast op traverse in rekening gebracht. Combinatie 6b bevat geen belastingen in geleider of op traverse. Deze combinatie is toegevoegd om te kunnen combineren met separate controle bordessen etc. De situaties worden in ULS en in iedere SPLS-situatie (in geval van hoekmast) toegepast.

	Fase	Bliksem
Lijnwagen	4,0 kN	2,0 kN
Puntlast op traverse	1,0 kN	1,0 kN

Beschouwde situaties bouw- en onderhoud 6a: 1 t/m 4, alle mogelijke situaties.

Aanwezigheid lijnwagen: Circuit, belasting tegelijk aanwezig in alle geleiders per circuit.

Principe belastingssituaties:

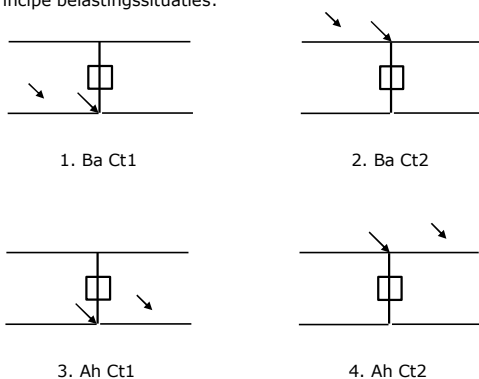

Belastingsituaties 8. Lijndansen als statische belasting

Geleider		
Steunmast fase	0,866 W	1,5 W
Steunmast bliksem	1,5 EDS	1,5 W
Hoekmast fase en bliksem	1,5 EDS	1,5 W

Considered situations galloping 8: 1 and 2, all possible situations

Belasting tegelijk aanwezig in alle geleiders van het circuit.

Principe belastingssituaties:

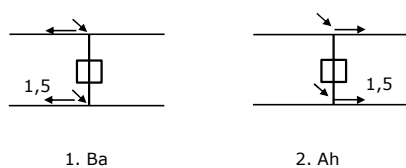

Belastingcombinatie 8. Lijndansen als dynamische belasting

Alleen van toepassing op hoek- en eindmasten

Belasting bestaat uit EDS-trekbelasting in één van de geleiders aan één zijde van de mast

Door gebruiker via het belastingsspectrum van tabel 4.11/NL.1 om te zetten naar spanningspectrum

Project: RLL-TLB380
 Tower: S+12_c - bouwfase
 Number: 1077

Mastconstructie

Eigenschappen

Masttype	Steunmast
Mastbenaming	S+12_c - bouwfase
Voetplaat t.o.v. maaiveld	0,5 m
Masthoogte t.o.v. voetplaat	68,7 m
Gewicht mast	581,0 kN

<i>Breedte en helling mast bij fundatie</i>	x-ri.	y-ri.
Pootsprei	12,94	12,94 m
Helling van de randstijl	0,150	0,150 -
Factor spatkracht	1,1	1,1 -

Berekening windbelasting

Dynamische invloed G_T	1,00 (<i>Masthoogte < 60 m</i>)
Windbelasting overhoeks op mastlichaam evenredig met:	$(A1C1\sin^2(\phi)+A2C2\cos^2(\phi))$
Windbelasting overhoeks op traverse evenredig met:	$(A1C1\sin^2(\phi)+A2C2\cos^2(\phi))$
Vergroting wind overhoeks mastlichaam	$(1+0,2\sin^2(2\phi))$
Vergroting wind overhoeks traverse	$(1+0,2\sin^2(2\phi))$
Factor wind evenwijdig t.o.v. haaks op traverse	0,4

Eigenschappen mastsecties langsrichting (vooraanzicht, yz-vlak)

Omschrijving	h [m]	b ₁ [m]	b ₂ [m]	Δh [m]	Δ _x [m]	A ₀ [m ²]	A ₁ [m ²]	χ = A ₁ /A ₀ [-]	C _t
Broekstuk	23,40	12,94	5,92	23,40	0,150	220,71	32,90	0,15	3,16
Eerste tussenstuk	36,10	5,92	3,90	12,70	0,079	62,40	14,15	0,23	2,82
Tweede tussenstuk	44,90	3,90	3,60	8,80	0,017	33,02	10,13	0,31	2,51
Bovenstuk 1	54,40	3,60	2,92	9,50	0,036	30,97	9,99	0,32	2,46
Bovenstuk 2	67,00	2,92	2,01	12,60	0,036	31,06	9,61	0,31	2,50
Topstuk	68,70	2,01		1,70		1,71	0,32	0,18	3,00
Ondertraverse	44,90	12,70		3,00		19,05	4,75	0,25	2,72
Middentraverse	54,40	16,34		3,00		24,51	6,81	0,28	2,62
Boventraverse	64,40	13,70	1,00	2,60		24,66	6,19	0,25	2,72

Eigenschappen mastsecties dwarsrichting (zijaanzicht, xz-vlak)

Omschrijving	h [m]	b ₁ [m]	b ₂ [m]	Δh [m]	Δ _x [m]	A ₀ [m ²]	A ₁ [m ²]	χ = A ₁ /A ₀ [-]	C _t
Broekstuk	23,40	12,94	5,92	23,40	0,150	220,71	32,90	0,15	3,16
Eerste tussenstuk	36,10	5,92	3,90	12,70	0,079	62,40	14,15	0,23	2,82
Tweede tussenstuk	44,90	3,90	3,60	8,80	0,017	33,02	10,13	0,31	2,51
Bovenstuk 1	54,40	3,60	2,92	9,50	0,036	30,97	9,99	0,32	2,46
Bovenstuk 2	67,00	2,92	2,01	12,60	0,036	31,06	9,61	0,31	2,50
Topstuk	68,70	2,01		1,70		1,71	0,32	0,18	3,00
Ondertraverse	44,90	12,70		3,00		19,05	4,75	0,25	2,72
Middentraverse	54,40	16,34		3,00		24,51	6,81	0,28	2,62
Boventraverse	64,40	13,70	1,00	2,60		24,66	6,19	0,25	2,72

NB: oppervlakte traverse dwarsrichting wordt in berekening gereduceerd.

Project: RLL-TLB380
 Tower: S+12_c - bouwfase
 Number: 1077

Windoppervlak feeders telecominstallaties

Onderdeel	A (m ² /m)	Factor	Δh	A ₁
Broekstuk	0,14	0,71	23,4	2,3
Eerste tussenstuk	0,14	0,71	12,7	1,3
Tweede tussenstuk	0,14	0,71	8,8	0,9
Bovenstuk 1	0,14	0,71	9,5	0,9
Bovenstuk 2				

Invoer antennes

Omschrijving	A (m ²)	h (m)	C _r (m)
Antenne top			
Antenne o.t.	4,7	51,2	1,5

Belastingen mastsectie langsrichting (x-richting) per windrichting

Omschrijving	P _w [kN/m ²]	F _{x1} [kN]	F _{x2} [kN]	F _{x3} [kN]	F _{x4} [kN]	h _{ef} [m]	M _{y1} [kNm]	M _{y2} [kNm]	M _{y3} [kNm]	M _{y4} [kNm]
Broekstuk	0,74	77,0	65,3	0,0	-65,3	11,7	900,5	764,1	0,0	-764,1
Eerste tussenstuk	0,99	39,3	33,3	0,0	-33,3	29,8	1169,1	992,0	0,0	-992,0
Tweede tussenstuk	1,07	27,3	23,2	0,0	-23,2	40,5	1105,8	938,3	0,0	-938,3
Bovenstuk 1	1,14	27,9	23,7	0,0	-23,7	49,7	1384,2	1174,6	0,0	-1174,6
Bovenstuk 2	1,19	28,7	24,4	0,0	-24,4	60,7	1742,1	1478,2	0,0	-1478,2
Topstuk	1,23	1,2	1,0	0,0	-1,0	67,9	78,9	66,9	0,0	-66,9
Ondertraverse	1,11	28,8	17,1	0,0	-17,1	45,9	1319,8	783,9	0,0	-783,9
Middentraverse	1,17	41,5	24,7	0,0	-24,7	55,4	2301,6	1367,1	0,0	-1367,1
Boventraverse	1,22	40,9	24,3	0,0	-24,3	65,3	2670,3	1586,1	0,0	-1586,1
Totaal		312,5	236,9	0,0	-236,9		12672,2	9151,1	0,0	-9151,1

Belastingen mastsectie dwarsrichting (y-richting) per windrichting

Omschrijving	P _w [kN/m ²]	F _{y1} [kN]	F _{y2} [kN]	F _{y3} [kN]	F _{y4} [kN]	h _{ef} [m]	M _{x1} [kNm]	M _{x2} [kNm]	M _{x3} [kNm]	M _{x4} [kNm]
Broekstuk	0,74	0,0	65,3	77,0	65,3	11,7	0,0	764,1	900,5	764,1
Eerste tussenstuk	0,99	0,0	33,3	39,3	33,3	29,8	0,0	992,0	1169,1	992,0
Tweede tussenstuk	1,07	0,0	23,2	27,3	23,2	40,5	0,0	938,3	1105,8	938,3
Bovenstuk 1	1,14	0,0	23,7	27,9	23,7	49,7	0,0	1174,6	1384,2	1174,6
Bovenstuk 2	1,19	0,0	24,4	28,7	24,4	60,7	0,0	1478,2	1742,1	1478,2
Topstuk	1,23	0,0	1,0	1,2	1,0	67,9	0,0	66,9	78,9	66,9
Ondertraverse	1,11	0,0	17,1	11,5	17,1	45,9	0,0	783,9	527,9	783,9
Middentraverse	1,17	0,0	24,7	16,6	24,7	55,4	0,0	1367,1	920,6	1367,1
Boventraverse	1,22	0,0	24,3	16,4	24,3	65,3	0,0	1586,1	1068,1	1586,1
Totaal		0,0	236,9	245,8	236,9		0,0	9151,1	8897,2	9151,1

Resulterende belastingen vanuit mastconstructie incl. antenne zonder geleiders niveau fundatie (kar. waarde)

Belasting / windrichting	F _x [kN]	F _y [kN]	F _z [kN]	M _x [kNm]	M _y [kNm]	M _z [kNm]
Permanente belasting	0	0	581	0	0	0
Windrichting 0°	321	0	0	0	13085	0
Windrichting 45°	243	243	0	9443	9443	0
Windrichting 90°	0	254	0	9310	0	0
Windrichting 135°	-243	243	0	9443	-9443	0

Project: RLL-TLB380
 Tower: S+12_c - bouwfase
 Number: 1077

Tussenresultaten geleiderbelastingen

Geleiders back

Circuit	Geleider	Diameter [mm]	A [mm ²]	G [N/m]	E [N/mm ²]	αT [-]
Circuit 1	AAAC-AL7 620	32,4	621,0	17,71	56000	2,30E-05
Circuit 2	AAAC-AL7 620	32,4	621,0	17,71	56000	2,30E-05
Bliksemdraad 1	AACSR 241-AL3-39-A20SA	21,8	281,0	9,38	70165	1,97E-05

Geleiders ahead

Circuit	Geleider	Diameter [mm]	A [mm ²]	G [N/m]	E [N/mm ²]	αT [-]
Circuit 1	AAAC-AL7 620	32,4	621,0	17,71	56000	2,30E-05
Circuit 2	AAAC-AL7 620	32,4	621,0	17,71	56000	2,30E-05
Bliksemdraad 1	AACSR 241-AL3-39-A20SA	21,8	281,0	9,38	70165	1,97E-05

Verticale belasting back

Circuit	Bundel [-]	Toeslag [%]	$w_{z,G}$ [N/m]	IJsg gebied	Formule	$w_{z,ijs}$ [N/m]	$w_{z,ijs,bundel}$ [N/m]
Circuit 1	4	3	73,0	B	4+0,2d	10,5	41,9
Circuit 2	2	3	36,5	B	4+0,2d	10,5	21,0
Bliksemdraad 1	1	2	9,6	A	15+0,4d	23,7	23,7

Verticale belasting ahead

Circuit	Bundel [-]	Toeslag [%]	$w_{z,G}$ [N/m]	IJsg gebied	Formule	$w_{z,ijs}$ [N/m]	$w_{z,ijs,bundel}$ [N/m]
Circuit 1	4	3	73,0	B	4+0,2d	10,5	41,9
Circuit 2	2	3	36,5	B	4+0,2d	10,5	21,0
Bliksemdraad 1	1	2	9,6	A	15+0,4d	23,7	23,7

Isolatoren

Geleider	$G_{isolator}$ [kN]	Aantal	$F_{v,iso}$ [kN]	Lengte [m]	Windopp. [m ²]	Windhoogte [m]	Stuwdruk [kN/m ²]	Vormfactor	$F_{th,iso}$ [kN]
380ct1f1	4,50	1	4,5	4,5	2,0	43,15	1,09	1,2	2,62
380ct1f2	4,50	1	4,5	4,5	2,0	52,65	1,15	1,2	2,76
380ct1f3	4,50	1	4,5	4,5	2,0	62,65	1,20	1,2	2,89
150ct2f1	2,50	1	2,5	4,0	1,4	43,40	1,09	1,2	1,84
150ct2f2	2,50	1	2,5	4,0	1,4	52,90	1,15	1,2	1,94
150ct2f3	2,50	1	2,5	4,0	1,4	62,90	1,20	1,2	2,02
bl1	0,10	1	0,1	0,2	0,1	66,30	1,22	1,2	0,15

Project: RLL-TLB380
 Tower: S+12_c - bouwfase
 Number: 1077

Windbelasting back

Geleider	hoogte		G _{c_dwars}	G _{c_trek}	C _c	d _{toeslag}	W _y	W _{y,vak}	D _{ijs,toeslag}	W _{y,ijs}	W _{y,ijs,vak}
	wind	Stuwdruk									
	[m]	[kN/m ²]	[-]	[-]	[-]	[mm]	[N/m]	[N/m]	[mm]	[N/m]	[N/m]
380ct1f1	33,5	1,02	0,59	0,59	1,00	33,37	79,4	79,4	51,8	148,6	148,6
380ct1f2	43,0	1,09	0,61	0,61	0,97	33,37	85,8	85,8	51,8	164,4	164,4
380ct1f3	53,0	1,15	0,62	0,62	0,95	33,37	91,3	91,3	51,8	178,3	178,3
150ct2f1	34,0	1,02	0,59	0,59	0,99	33,37	39,9	39,9	51,8	74,8	74,8
150ct2f2	43,5	1,09	0,61	0,61	0,97	33,37	43,1	43,1	51,8	82,6	82,6
150ct2f3	53,5	1,16	0,62	0,62	0,95	33,37	45,8	45,8	51,8	89,5	89,5
bl1	58,8	1,18	0,63	0,63	1,18	22,24	19,5	19,5	63,1	56,5	56,5

Windbelasting ahead

Geleider	hoogte		G _{c_dwars}	G _{c_trek}	C _c	d _{toeslag}	W _y	W _{y,vak}	D _{ijs,toeslag}	W _{y,ijs}	W _{y,ijs,vak}
	wind	Stuwdruk									
	[m]	[kN/m ²]	[-]	[-]	[-]	[mm]	[N/m]	[N/m]	[mm]	[N/m]	[N/m]
380ct1f1	33,5	1,02	0,59	0,59	1,00	33,37	79,4	79,4	51,8	148,6	148,6
380ct1f2	43,0	1,09	0,61	0,61	0,97	33,37	85,8	85,8	51,8	164,4	164,4
380ct1f3	53,0	1,15	0,62	0,62	0,95	33,37	91,3	91,3	51,8	178,3	178,3
150ct2f1	34,0	1,02	0,59	0,59	0,99	33,37	39,9	39,9	51,8	74,8	74,8
150ct2f2	43,5	1,09	0,61	0,61	0,97	33,37	43,1	43,1	51,8	82,6	82,6
150ct2f3	53,5	1,16	0,62	0,62	0,95	33,37	45,8	45,8	51,8	89,5	89,5
bl1	58,8	1,18	0,63	0,63	1,18	22,24	19,5	19,5	63,1	56,5	56,5

Project: RLL-TLB380
 Masttype: S+12_c - bouwfase
 Mast: 1077

Auteur: TBR
 Versie: v11.8

Geleiderbelastingen

Uitgangspunten

Betrouwbaarheidsniveau Nieuwbouw CC2
 Referentieperiode 15 jaar

ULS (bezwijksterkte)		NEN-EN50341-2-15:2019						
Belastingsgeval	omschrijving	Temp °C	γ_G		γ_Q			γ_a A_k
			$G_{k,mast}$	$G_{k,geleider}$	Q_{pk}	Q_{wk}	Q_{ik}	
ULS 1a	Wind	10°	1,20	1,20	0,00	1,25	0,00	0,0
ULS 1a_0,9	Wind 0,9Gk alleen mast	10°	0,90	1,20	0,00	1,25	0,00	0,0
ULS 1a_0,9_0,9	Wind 0,9Gk ook geleider	10°	0,90	0,90	0,00	1,25	0,00	0,0
ULS 3	Wind+ijs	-5°	1,20	1,20	0,00	0,38	1,07	0,0
ULS 3_0,9	Wind+ijs 0,9	-5°	0,90	1,20	0,00	0,38	1,07	0,0
ULS 4	Koude+wind	-20°	1,20	1,20	0,00	0,25	0,00	0,0
ULS 4_0,9	Koude+wind 0,9	-20°	0,90	1,20	0,00	0,25	0,00	0,0
ULS 5a	Torsiebelastingen	10°	1,00	1,00	1,00	0,00	0,00	1,0
ULS 5b	Longitudinale belastingen	10°	1,00	1,00	0,00	0,00	0,00	1,0
ULS 6	Bouw en onderhoud	5°	1,20	1,20	1,50	0,25	0,00	0,0
ULS 6_0,9	Bouw en onderhoud	5°	1,20	1,20	0,00	0,25	0,00	0,0
ULS 7	Permanent	10°	1,35	1,35	0,00	0,00	0,00	0,0
ULS 8	Special	10°	1,00	1,00	0,00	0,00	0,00	1,0
SPLS (Bezwijksterkte, enkel voor hoekmasten: afwezigheid geleiders)			γ_G		γ_Q			
			G_k		Q_{pk}	Q_{wk}	Q_{ik}	A_k
SPLS 1a	Wind	10°	1,20	1,20	0,0	0,78	0,00	0,0
SPLS 1a_0,9	Wind 0,9	10°	0,90	1,20	0,0	0,78	0,00	0,0
SPLS 1a_0,9_0,9	Wind 0,9	10°	0,90	0,90	0,0	0,78	0,00	0,0
SPLS 3	Wind+ijs	-5°	1,20	1,20	0,0	0,36	0,34	0,0
SPLS 3_0,9	Wind+ijs 0,9	-5°	0,90	1,20	0,0	0,36	0,34	0,0
SPLS 4	Koude+wind	-20°	1,20	1,20	0,0	0,24	0,00	0,0
SPLS 4_0,9	Koude+wind 0,9	-20°	0,90	1,20	0,0	0,24	0,00	0,0
SPLS 6	Bouw en onderhoud	5°	1,20	1,20	1,2	0,24	0,0	0,0
SPLS 6_0,9	Bouw en onderhoud	5°	1,20	1,20	0,0	0,24	0,0	0,0
SLS (controle van de vervormingen, vermoeiing, EDS)			G_k		Q_{pk}	Q_{wk}	Q_{ik}	A_k
SLS 1a	Wind	10°	1,00	1,00	0,0	0,87	0,0	0,0
SLS 3	Wind+ijs	-5°	1,00	1,00	0,0	0,26	0,71	0,0
SLS 4	Wind	-20°	1,00	1,00	0,0	0,17	0,0	0,0
SLS 6	Bouw en onderhoud	5°	1,00	1,00	0,0	0,17	0,0	0,0
SLS 7	PB (EDS, geen wind)	10°	1,00	1,00	0,0	0,00	0,0	0,0

Aantal windrichtingen 6
 Aantal belastingcombinaties ULS 54
 Aantal belastingcombinaties SPLS 0
 Aantal belastingcombinaties SLS 15
 Aantal knooplasten 483

Project: RLL-TLB380
 Masttype: S+12_c - bouwfase
 Mast: 1077

Samenvattingstabellen geleiderbelastingen

In de onderstaande vier tabellen is weergegeven:

- De maximale geleiderbelasting in het globale assenstelsel, gesplitst in aandeel van back en ahead span
- De gecombineerde geleiderbelasting (Ba+Ah) in het globale assenstelsel met in het lokale assenstelsel de maximaal optredende trekkracht. Componenten Fx en Fy als absolute waarde
- De alledaagse (EDS) waarden van de gecombineerde geleiderbelastingen (Ba+Ah) met bijbehorende trekkrachten
- Controle op uplift, waar een negatieve waarde duidt op uplift

Maximale waarden voor back en ahead span

Geleider	Fx_ba [kN]	Fx_ah [kN]	Fy_ba [kN]	Fy_ah [kN]	Fz_ba [kN]	Fz_ah [kN]
bl1	-54,5	54,5	5,0	5,0	8,6	8,6
380ct1f1	-236,3	236,3	21,5	21,5	36,3	36,3
380ct1f2	-239,2	239,2	23,2	23,2	36,4	36,4
380ct1f3	-242,0	242,0	24,7	24,7	36,5	36,5
150ct2f1	-118,2	118,2	11,1	11,1	20,5	20,5
150ct2f2	-119,7	119,7	12,0	12,0	20,5	20,5
150ct2f3	-121,1	121,1	12,7	12,7	20,5	20,5

Min. Weight span (m)

Weight spar Combinatie1

Geleider	SLS 1a	SLS 4	SLS 7
bl1	508,0	528,6	508,0
380ct1f1	508,0	527,2	508,0
380ct1f2	508,0	527,5	508,0
380ct1f3	508,0	527,7	508,0
150ct2f1	508,0	527,2	508,0
150ct2f2	508,0	527,5	508,0
150ct2f3	508,0	527,7	508,0

Max. Weight span (m)

Weight spar Combinatie1

Geleider	ULS 1a	ULS 3
bl1	604,6	495,3
380ct1f1	544,6	507,0
380ct1f2	549,8	508,4
380ct1f3	554,2	509,6
150ct2f1	544,9	507,1
150ct2f2	550,0	508,4
150ct2f3	554,4	509,7

Omhullende weight span over alle combinaties (incl. 0,9 combinaties)

Voor alle geleiders

Max. weight span	604,6 m
Min. weight span	400,0 m

Wind / Weight span verhouding

1,512 -
1,000 -

Project: RLL-TLB380
 Masttype: S+12_c - bouwfase
 Mast: 1077

Maximale waarden back+ahead span Maximale waarden trekkracht geleider

Geleider	Fx	Fy	Fz	Ft_ba	Ft_ah
	[kN]	[kN]	[kN]	[kN]	[kN]
bl1	25,8	10,0	17,1	-54,5	54,5
380ct1f1	105,1	43,1	72,6	-236,3	236,3
380ct1f2	105,1	46,5	72,7	-239,2	239,2
380ct1f3	105,1	49,4	72,9	-242,0	242,0
150ct2f1	52,5	22,3	36,6	-118,2	118,2
150ct2f2	52,5	24,0	36,7	-119,7	119,7
150ct2f3	52,5	25,5	36,8	-121,1	121,1

EDS-belastingen geleiders

Geleider	Fx	Fy	Fz	Ft_ba	Ft_ah
	[kN]	[kN]	[kN]	[kN]	[kN]
bl1	0,0	0,0	5,0	-17,2	17,2
380ct1f1	0,0	0,0	41,6	-131,3	131,3
380ct1f2	0,0	0,0	41,6	-131,3	131,3
380ct1f3	0,0	0,0	41,6	-131,3	131,3
150ct2f1	0,0	0,0	21,0	-65,7	65,7
150ct2f2	0,0	0,0	21,0	-65,7	65,7
150ct2f3	0,0	0,0	21,0	-65,7	65,7

Controle uplift SLS-wind

Combinatie: Geleider	Fz_ba	Fz_ah
	[kN]	[kN]
SLS 4 bl1	2,6	2,6
380ct1f1	21,5	21,5
380ct1f2	21,5	21,5
380ct1f3	21,5	21,5
150ct2f1	10,9	10,9
150ct2f2	10,9	10,9
150ct2f3	10,9	10,9

Project: RLL-TLB380
 Masttype: S+12_c - bouwfase
 Mast: 1077

ULS-fundatiebelasting combinatie 1 en 3 wind haaks op de lijn of bissectrice en EDS, vanuit geleiders

Combinatie	Combination	F_x [kN]	F_y [kN]	F_z [kN]	M_x [kNm]	M_y [kNm]	M_z [kNm]
ULS 1a_90		0	221	249	14489	0	0
ULS 1a_0,9_0		9	0	188	1704	496	79
ULS 1a_0,9_0,9_90		0	221	141	13525	0	0
ULS 3_0		3	0	340	2885	149	24
SLS 7		0	0	193	1750	0	0

ULS-fundatiebelasting combinatie 1 en 3 wind haaks op de lijn of bissectrice en EDS, totaal geleiders en mast

Combinatie	F_x [kN]	F_y [kN]	F_z [kN]	M_x [kNm]	M_y [kNm]	M_z [kNm]
ULS 1a_90	0	539	946	26154	0	0
ULS 1a_0,9_0,9_90	0	539	664	25191	0	0
SLS 7	0	0	774	1750	0	0

Fundatiebelastingen, selectie belastingcombinaties op basis grootste waarde

Combinatie	F_x [kN]	F_y [kN]	F_z [kN]	M_x [kNm]	M_y [kNm]	M_z [kNm]
ULS 1a_90	0	539	946	26154	0	0
ULS 1a_0,9_0,9_0	411	0	664	1278	16892	79
ULS 5a Ba 11	105	0	762	1526	5716	1471
ULS 1a_45	310	418	933	20292	12183	56

Noot: grootste waarden kunnen in meerdere combinaties voorkomen, een combinatie is weergegeven.

Oplegreacties op fundering per randstijl

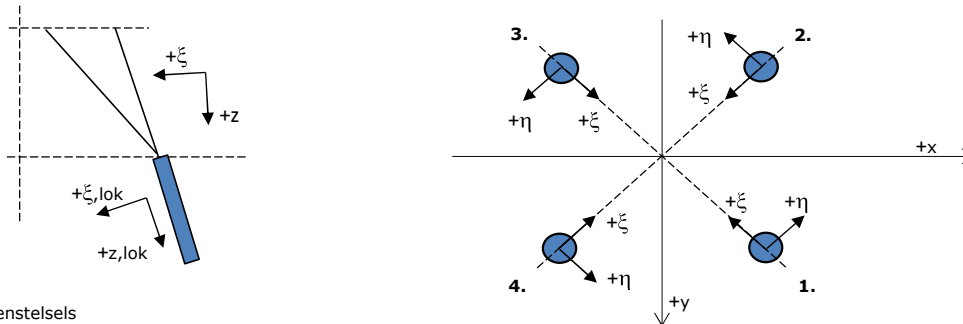

Assenstelsels

Maximale drukbelasting

Stijl	Combinatie	R_x [kN]	R_y [kN]	R_z [kN]	R_η [kN]	R_ξ [kN]	$R_{\xi,lok}$ [kN]	$R_{z,lok}$ [kN]
1	ULS 1a_45	246	220	1488	19	-330	-14	1521
2	ULS 1a_270	177	-174	1074	-2	-248	-20	1098
3	ULS 1a_225	-217	-222	1323	-3	-310	-30	1353
4	ULS 1a_135	-246	220	1488	-19	-330	-14	1521

Maximale trekbelasting

Stijl	Combinatie	R_x [kN]	R_y [kN]	R_z [kN]	R_η [kN]	R_ξ [kN]	$R_{\xi,lok}$ [kN]	$R_{z,lok}$ [kN]
1	ULS 1a_0,9_0,9_225	-159	-154	-957	-4	221	18	-978
2	ULS 1a_0,9_135	-174	154	-1060	14	232	7	-1084
3	ULS 1a_0,9_45	174	154	-1060	-14	232	7	-1084
4	ULS 1a_0,9_0,9_270	117	-107	-709	7	159	8	-724

Maximale torsiebelasting (positief)

Stijl	Combinatie	R_x [kN]	R_y [kN]	R_z [kN]	R_η [kN]	R_ξ [kN]	$R_{\xi,lok}$ [kN]	$R_{z,lok}$ [kN]
1	ULS 5a Ba 11	96	39	470	40	-96	4	481
2	ULS 5a Ba 11	20	-96	352	54	-82	-7	360
3	ULS 5a Ba 11	-24	33	-89	40	7	-12	-91
4	ULS 5a Ba 11	14	23	29	26	-7	-1	29

Maximale torsiebelasting (negatief)

Stijl	Combinatie	R_x [kN]	R_y [kN]	R_z [kN]	R_η [kN]	R_ξ [kN]	$R_{\xi,lok}$ [kN]	$R_{z,lok}$ [kN]
1	ULS 5a Ah 11	-14	23	29	-26	-7	-1	29
2	ULS 5a Ah 11	24	33	-89	-40	7	-12	-91
3	ULS 5a Ah 11	-20	-96	352	-54	-82	-7	360
4	ULS 5a Ah 11	-96	39	470	-40	-96	4	481

Project: RLL-TLB380
 Masttype: S+12_c - bouwfase
 Mast: 1077

Combinatie Ftrek+Fhor

Stijl	Combinatie	R _x [kN]	R _y [kN]	R _z [kN]	R _η [kN]	R _ξ [kN]	R _{ξ,lok} [kN]	R _{z,lok} [kN]
1	ULS 1a_0,9_0,9_225	-159	-154	-957	-4	221	18	-978
2	ULS 1a_0,9_135	-174	154	-1060	14	232	7	-1084
3	ULS 1a_0,9_45	174	154	-1060	-14	232	7	-1084
4	ULS 1a_0,9_0,9_270	117	-107	-709	7	159	8	-724

Permanente belasting

Stijl	Combinatie	R _x [kN]	R _y [kN]	R _z [kN]	R _η [kN]	R _ξ [kN]	R _{ξ,lok} [kN]	R _{z,lok} [kN]
1	SLS 7	43	32	261	8	-53	2	267
2	SLS 7	21	-32	126	8	-37	-11	129
3	SLS 7	-21	-32	126	-8	-37	-11	129
4	SLS 7	-43	32	261	-8	-53	2	267

Omhullenden ongeacht stijl

Belasting	Combinatie	R _x [kN]	R _y [kN]	R _z [kN]	R _η [kN]	R _ξ [kN]	R _{ξ,lok} [kN]	R _{z,lok} [kN]
Max. druk	ULS 1a_45	246	220	1488	19	-330	-14	1521
Max. trek	ULS 1a_0,9_45	174	154	-1060	-14	232	7	-1084
Max. pos. torsie	ULS 5a Ba 11	20	-96	352	54	-82	-7	360
Max. neg. torsie	ULS 5a Ah 11	-20	-96	352	-54	-82	-7	360
Comb. trek+torsie	ULS 1a_0,9_45	174	154	-1060	-14	232	7	-1084

Maximale trekbelasting SLS

Stijl	Combinatie	R _x [kN]	R _y [kN]	R _z [kN]	R _η [kN]	R _ξ [kN]	R _{ξ,lok} [kN]	R _{z,lok} [kN]
1	SLS 7	43	32	261	8	-53	2	267
2	SLS 1a_135	-112	95	-685	12	146	1	-700
3	SLS 1a_45	112	95	-685	-12	146	1	-700
4	SLS 1a_0	29	-41	-190	-9	50	9	-194

Maximale drukbelasting SLS

Stijl	Combinatie	R _x [kN]	R _y [kN]	R _z [kN]	R _η [kN]	R _ξ [kN]	R _{ξ,lok} [kN]	R _{z,lok} [kN]
1	SLS 1a_45	178	157	1073	15	-237	-9	1097
2	SLS 1a_0	91	-107	577	12	-140	-18	590
3	SLS 7	-21	-32	126	-8	-37	-11	129
4	SLS 1a_135	-178	157	1073	-15	-237	-9	1097

Project: RLL-TLB380
Masttype: S+12_c - bouwfase
Mast: 1077

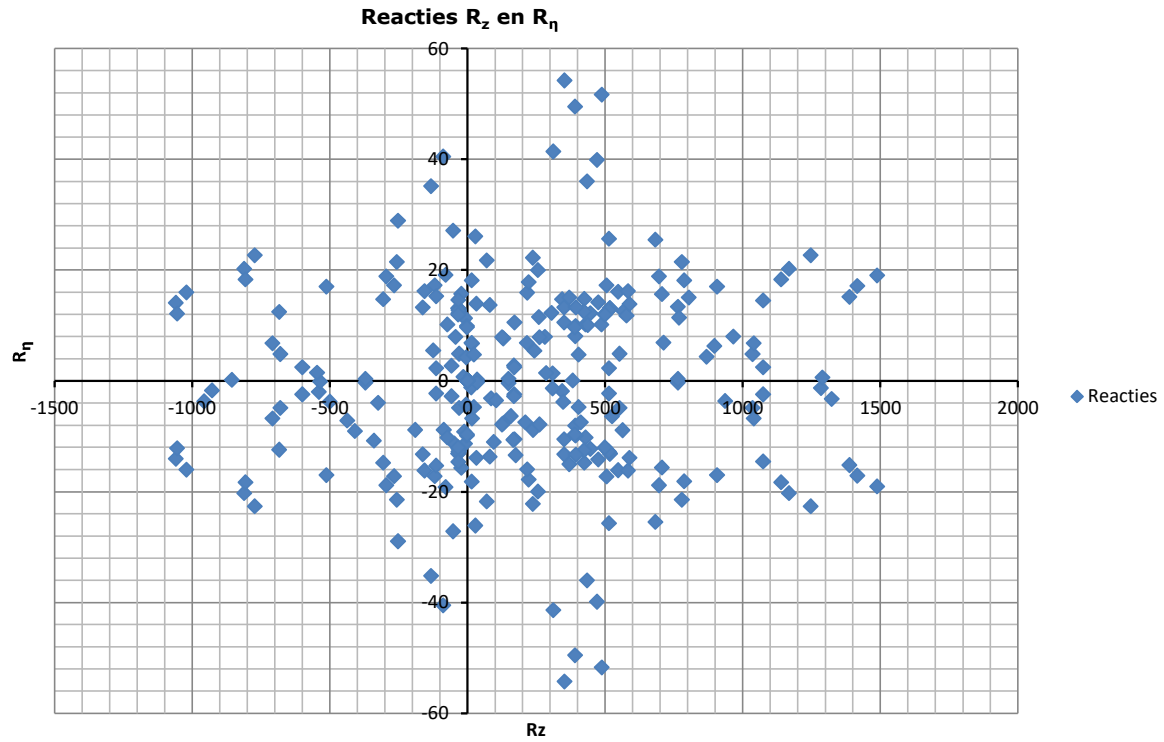

Hoisting load

Date: 2021-02-22
 Author: TBR
 Version: 1.1

RLL-TLB
 S+0_c

Uitvoer geleiderbelastingen

Belastingcombi	nummer	Fxtotaal	Fytotaal	Fzttotaal	Ftrekahead	Ftrekback
ULS 6b_90	10	0.0	10.3	50.0	159.9	-159.9
	11	0.0	11.1	50.1	160.6	-160.6
	12	0.0	11.8	50.1	161.3	-161.3
	20	0.0	10.3	50.0	159.9	-159.9
	21	0.0	11.1	50.1	160.6	-160.6
	22	0.0	11.8	50.1	161.3	-161.3
	30	0.0	5.3	25.3	80.0	-80.0
	31	0.0	5.7	25.3	80.3	-80.3
	32	0.0	6.1	25.4	80.6	-80.6
	40	0.0	5.3	25.3	80.0	-80.0
	41	0.0	5.7	25.3	80.3	-80.3
	42	0.0	6.1	25.4	80.6	-80.6
	1	0.0	2.4	6.0	22.3	-22.3
	3	0.0	2.4	5.9	21.8	-21.8

Extra belastingfactor voor hijsen: $\gamma_{f,dyn} = 1.2$ kN
 Extra belasting voor hijsmiddelen: $F_{kar} = 1$ kN
 Rekenwaarde: $F_{Ed} = 1.2$ kN

Invoer in PLS-TOWER

Load Case	Joint Label	Vertical Load (N)	Transverse Load (N)	Longitudinal Load (N)	Load Comment
Hoisting load	4P_84SF0.50S	10315	61459	0	
Hoisting load	4P_84SF0.50X	11128	61511	0	
Hoisting load	7P_51SF0.50S	11822	61559	0	
Hoisting load	7P_51SF0.50X	10315	61459	0	
Hoisting load	10P_27SF0.50S	11128	61511	0	
Hoisting load	10P_27SF0.50X	11822	61559	0	
Hoisting load	0i0.52E33S	5338	31811	0	
Hoisting load	0i0.52E33X	5749	31837	0	
Hoisting load	0i0.51E42S	6100	31860	0	
Hoisting load	0i0.51E42X	5338	31811	0	
Hoisting load	1i0.51E52S	5749	31837	0	
Hoisting load	1i0.51E52X	6100	31860	0	

Insulator failure case

Date: 2021-02-22
 Author: TBR
 Version: 1.1

RLL-TLB
 S+0_c

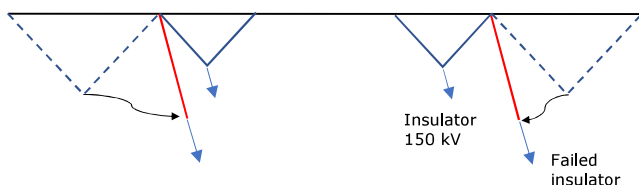

Uitvoer geleiderbelastingen

Belastingcombi	nummer	Fxtotaal	Fytotaal	Fztotaal	Ftrekahead	Ftrekback
SLS 1a_90	10	0.0	34.4	44.5	179.6	-179.6
	11	0.0	37.1	44.8	185.8	-185.8
	12	0.0	39.4	45.2	191.3	-191.3
	20	0.0	34.4	44.5	179.6	-179.6
	21	0.0	37.1	44.8	185.8	-185.8
	22	0.0	39.4	45.2	191.3	-191.3
	30	0.0	17.8	22.5	90.0	-90.0
	31	0.0	19.2	22.7	93.1	-93.1
	32	0.0	20.3	22.8	95.8	-95.8
	40	0.0	17.8	22.5	90.0	-90.0
	41	0.0	19.2	22.7	93.1	-93.1
	42	0.0	20.3	22.8	95.8	-95.8
	1	0.0	7.9	5.9	33.1	-33.1
	3	0.0	7.9	5.8	32.7	-32.7
SLS 3_90	10	0.0	18.6	63.1	210.6	-210.6
	11	0.0	20.6	63.2	212.9	-212.9
	12	0.0	22.3	63.4	215.1	-215.1
	20	0.0	18.6	63.1	210.6	-210.6
	21	0.0	20.6	63.2	212.9	-212.9
	22	0.0	22.3	63.4	215.1	-215.1
	30	0.0	9.5	31.8	105.4	-105.4
	31	0.0	10.5	31.9	106.5	-106.5
	32	0.0	11.3	31.9	107.6	-107.6
	40	0.0	9.5	31.8	105.4	-105.4
	41	0.0	10.5	31.9	106.5	-106.5
	42	0.0	11.3	31.9	107.6	-107.6
	1	0.0	6.8	16.5	51.5	-51.5
	3	0.0	6.8	16.3	50.8	-50.8



APPENDIX B

Resultaten PLS-TOWER

Deze Appendix bevat de resultaten uit PLS-TOWER voor de verschillende masttypen. De samenstelling van de bovenstukken zijn voor alle masttypen gelijk. De resultaten van het bovenstuk zijn dan ook alleen opgenomen van het maatgevende masttype S+12/c. De resultaten van het onderstuk zijn voor alle masten opgenomen.

Resultaten opgenomen voor:

- Masttype S-3/c
- Masttype S+0/c
- Masttype S+3/c
- Masttype S+6/c
- Masttype S+9/c
- Masttype S+12/c

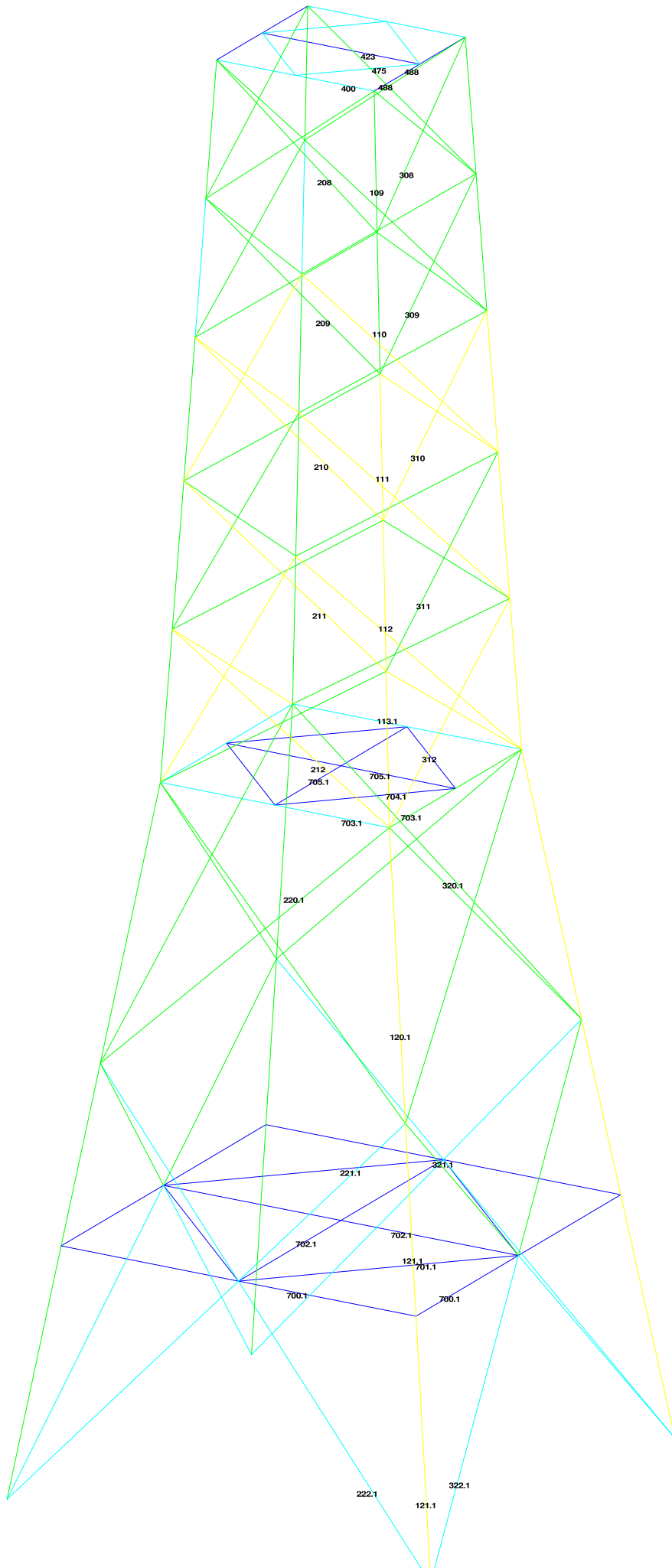

1 (m)



Assessment of angle groups - Tower footage

Date: 5/4/2021
 Author: TBR
 Version: 1.0

RLI-TLB
 S-3_c

Group Label	Description	Type	Profile	Steel Quail Bolts	#shyplant01	e2	p1	RLX	RLY	RLZ	Stiffness	Compression	Load Case (Compression)	Buckling	Shear (Comp.)	U.C. (Comp.)	Tension	Load Case (Tension)	Net Section ear	(Tens) Jting (Tens)	U.C. (Tens)			
109	Main leg	EA	180x180x16	S355	6N24-8.8T	2	55	40	80	80	43	-1046.1	US 18_0_9_0_9_90	1724.9	1626.6	1693.4	0.64	800.1	US 18_0_9_0_9_90	1661.0	1592.1	0.50		
110	Main leg	EA	180x180x16	S355	6N24-8.8T	2	55	40	80	80	43	-1356.8	US 18_0_9_0_9_90	1719.5	2168.8	2257.9	0.79	1105.0	US 18_0_9_0_9_90	1661.0	2168.8	0.57		
111	Main leg	EA	180x180x16	S355	6N24-8.8T	2	55	40	80	80	44	-1529.8	US 18_135	1923.2	0.0	0.0	0.80	1250.7	US 18_0_9_0_9_90	2197.5	0.0	0.0	0.67	
208	Diag front face	EA	100x100x10	S355	2N24-8.8T	1	55	40	80	0.52	0.52	127	-161.4	US 18_90	230.8	271.1	352.8	0.70	137.5	US 18_90	305.3	271.1	0.51	
209	Diag front face	EA	100x100x10	S355	2N24-8.8T	1	55	40	80	0.52	0.52	143	-138.4	US 18_90	162.7	271.1	352.8	0.70	137.5	US 18_90	305.3	271.1	0.51	
210	Diag front face	EA	100x100x10	S355	2N24-8.8T	1	55	40	80	0.52	0.52	143	-138.4	US 18_90	162.7	271.1	352.8	0.70	137.5	US 18_90	305.3	271.1	0.51	
211	Diag front face	EA	100x100x10	S355	2N24-8.8T	1	55	40	80	0.52	0.52	150	-114.3	US 18_90	149.6	271.1	352.8	0.76	124.0	US 18_90	246.8	271.1	0.48	
212	Diag front face	EA	100x100x10	S355	2N24-8.8T	1	55	40	80	0.52	0.52	159	-117.9	US 18_90	138.0	271.1	352.8	0.76	124.0	US 18_90	246.8	271.1	0.50	
308	Diag side face	EA	100x100x10	S355	2N24-8.8T	1	55	40	80	0.52	0.52	127	-146.8	US 58 Ah 11	230.8	271.1	352.8	0.64	145.6	US 58 Ah 11	305.3	271.1	0.54	
309	Diag side face	EA	100x100x10	S355	2N24-8.8T	1	55	40	80	0.52	0.52	143	-138.4	US 58 Ah 11	162.7	271.1	352.8	0.64	145.6	US 58 Ah 11	305.3	271.1	0.54	
310	Diag side face	EA	100x100x10	S355	2N24-8.8T	1	55	40	80	0.52	0.52	141	-123.3	US 58 Ah 11	162.7	271.1	352.8	0.76	113.5	US 58 Ah 11	246.8	271.1	0.48	
311	Diag side face	EA	100x100x10	S355	2N24-8.8T	1	55	40	80	0.52	0.52	159	-108.3	US 58 Ah 11	149.6	271.1	352.8	0.72	113.5	US 58 Ah 11	246.8	271.1	0.46	
702.1	Diag side face	EA	100x100x8	S355	2N24-8.8T	1	55	40	80	0.52	0.52	159	-105.7	US 58 Ah 11	138.0	271.1	352.8	0.72	98.0	US 58 Ah 11	246.8	271.1	0.40	
703.1	Diag side face	EA	110x110x10	S355	2N24-8.8T	1	45	35	70	2.00	1.00	155	-132.5	US 18_90	195.0	271.1	352.8	0.72	95.8	US 18_0_9_0_9_90	307.1	271.1	0.43	
704.1	Diag side face	EA	110x110x10	S355	2N24-8.8T	1	45	35	70	2.00	1.00	155	-132.5	US 18_90	195.0	271.1	352.8	0.72	95.8	US 18_0_9_0_9_90	307.1	271.1	0.43	
705.1	Diag side face	EA	60x60x6 (net con)	S355	1N20-8.8T	1	45	35	70	0.50	0.50	224	-4.1	US 18_90	66.5	94.1	80.2	0.00	0.0	0.0	112.9	94.1	80.2	0.00
120.1	Main leg	EA	180x180x18	S355	10N24-8.8T	2	55	40	80	0.39	0.29	49	-1694.5	US 18_45	1866.2	2711.0	3176.2	0.91	1381.0	US 18_0_9_0_9_90	1853.6	2711.0	2955.2	0.75
121.1	Main leg	EA	200x200x18	S355	10N24-8.8T	2	55	40	80	0.50	0.50	49	-1692.9	US 18_45	2075.3	2711.0	3176.2	0.79	1296.0	US 18_0_9_0_9_90	2107.6	2711.0	2955.2	0.61
122.1	Diag front face	EA	100x100x10	S355	2N24-8.8T	1	55	40	80	0.50	0.50	170	-90.3	US 58 Bn 21	148.4	271.1	352.8	0.47	67.9	US 58 Bn 21	305.3	271.1	0.26	
221.1	Diag front face	EA	100x100x10	S355	2N24-8.8T	1	55	40	80	1.00	0.50	170	-72.9	US 58 Bn 21	148.4	271.1	352.8	0.47	67.9	US 58 Bn 21	305.3	271.1	0.26	
320.1	Diag side face	EA	130x130x12	S355	2N24-8.8T	1	55	40	80	1.00	0.33	181	-212.8	US 58 Bn 21	212.8	271.1	423.4	0.34	64.7	US 58 Bn 21	494.4	271.1	0.24	
320.1	Diag side face	EA	100x100x10	S355	2N24-8.8T	1	55	50	80	0.58	0.29	161	-97.3	US 58 Bn 21	159.4	271.1	352.8	0.61	96.1	US 58 Bn 21	305.3	271.1	0.35	
321.1	Diag side face	EA	100x100x10	S355	2N24-8.8T	1	55	40	80	1.00	0.50	170	-77.9	US 58 Bn 11	148.4	271.1	352.8	0.53	75.5	US 58 Bn 21	305.3	271.1	0.28	
700.1	Diag side face	EA	80x80x8	S355	1N20-8.8T	1	45	35	80	1.00	1.00	230	-4.7	US 18_0_9_0_9_45	64.0	94.1	117.6	0.15	3.5	US 18_0_9_0_9_45	150.5	94.1	106.9	0.04
701.1	Diag side face	EA	80x80x8	S355	1N20-8.8T	1	45	35	80	1.00	1.00	230	-4.7	US 18_0_9_0_9_45	64.0	94.1	117.6	0.15	3.5	US 18_0_9_0_9_45	150.5	94.1	106.9	0.04
702.1	Diag side face	EA	90x90x8 (net con)	S355	1N16-8.8T	1	35	40	80	0.50	0.50	230	-0.6	US 18_90	127.9	60.3	94.1	0.01	0.0	0.0	194.4	60.3	81.3	0.00
1131.1	Main leg	EA	180x180x18	S355	10N24-8.8T	2	55	40	80	0.52	0.52	47	-1611.8	US 18_45	1884.0	2711.0	3175.2	0.88	1344.8	US 18_0_9_0_9_90	1855.6	2711.0	2985.2	0.73

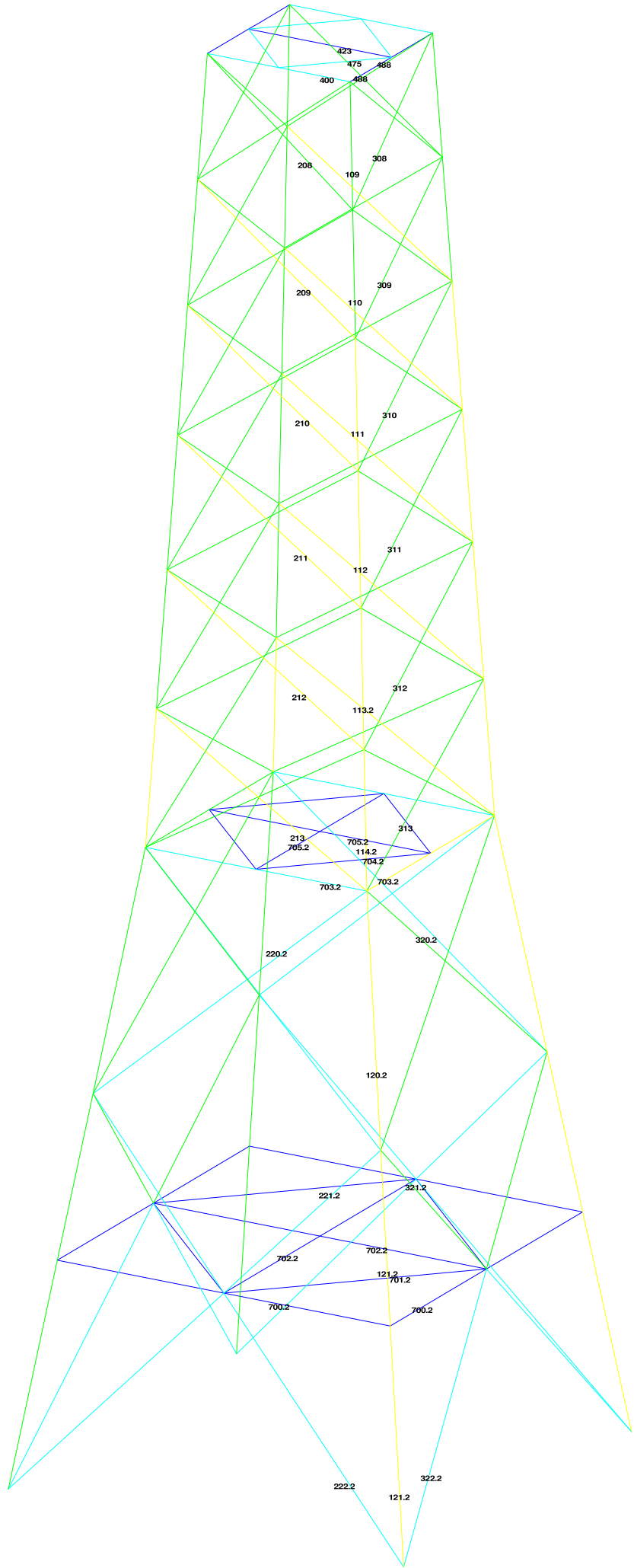

1 (m)



Assessment of angle groups - Tower footage

Date 5/4/2021
Author TBR
Version 1.0

RLT-TLB
S+0_C

Table with columns: Group Label, Description, Type, Profile, Steel Quail Bolts, #shp/plant/c1, e2, p1, RLK, RLY, R LZ, Stiffness, Compression, Load Case (Compression), Buckling Shear (Comp), U.C. (Comp), Tension, Load Case (Tension), Net Section ear (Tens), U.C. (Tens). Rows include various structural members like Main leg, Diagonal brace, and Diagonal brace.

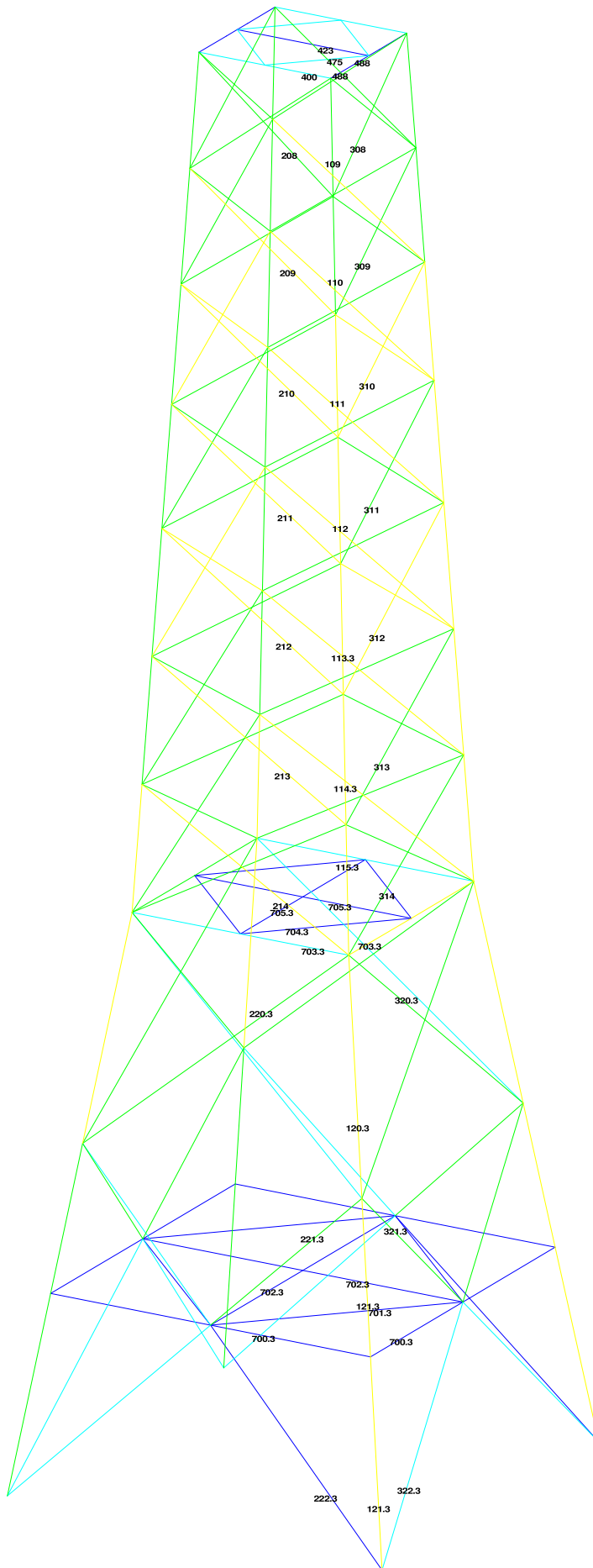

1 (m)



Assessment of angle groups - Lower structure

Date 5/4/2021
Author TBR
Version 1.0

RL-TLB
S+3_C

Table with columns: Group Label, Description, Type, Profile, Stead Qual Bolts, #h,pl e1, e2, p1, RLX, RLY, RLZ, Slenderness, Compression, Load Case (Compression), Buckling Shear (Comp) ailing (Comp), U.C. (Comp), Tension, Load Case (Tension), Net Section ear (Tens) Jntng (Tens), U.C. (Tens). Rows include structural details like Main leg, Diagonal brace, and Diagonal brace breakstut.

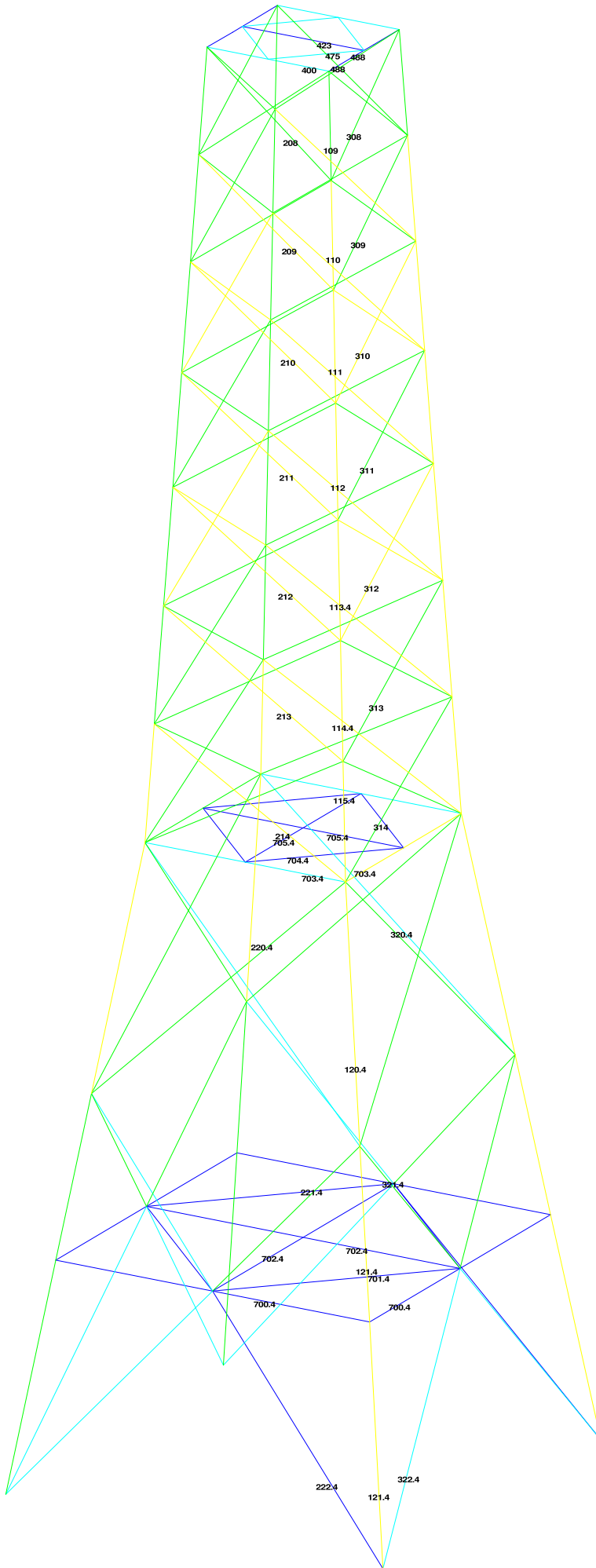

1 (m)



Assessment of angle groups - Lower structure

Date 5/4/2021
Author TBR
Version 1.0

RLT-TLB
S+6_c

Table with columns: Group Label, Description, Type, Profile, Steel Qual, Bolts, #shiplt, e2, p1, RLK, RLY, R LZ, Stiffness, Compression, Load Case (Compression), Buckling Shear (Comp), U.C. (Comp), Tension, Load Case (Tension), Net Section Area (Tens), Infilng (Tens), U.C. (Tens). Rows include structural details like Main leg, Diagonal brace, and various load cases.

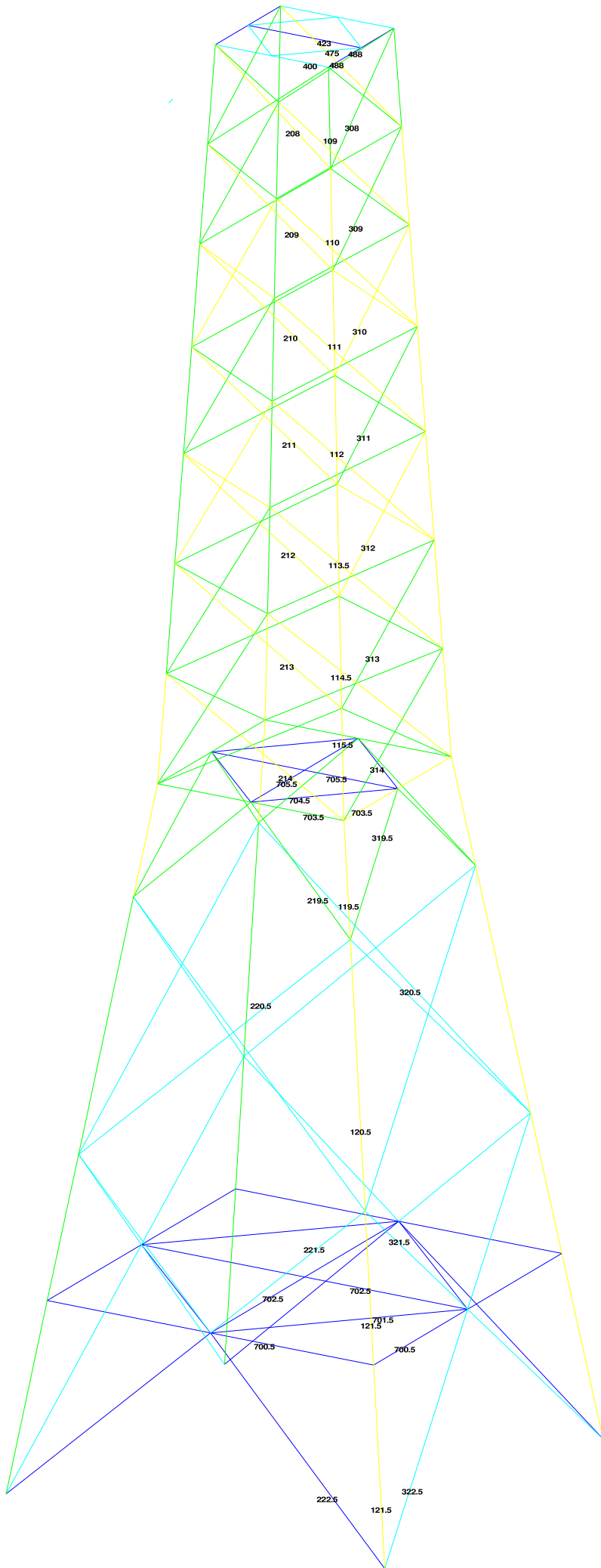

1 (m)



Assessment of angle groups - Lower structure

Date 5/4/2021
Author TBR
Version 1.0

RLT-TLB
S+9_c

Table with columns: Group Label, Description, Type, Profile, Steel Qual, Bolts, e1, e2, d1, RLK, RLY, R LZ, Slenderness, Compression, Load Case (Compression), Buckling, Shear, (Comp) arning, (Comp) U.C., (Comp) U.C., Tension, Load Case (Tension), Net Section Area, (Tens) arning, (Tens) U.C., (Tens) U.C.

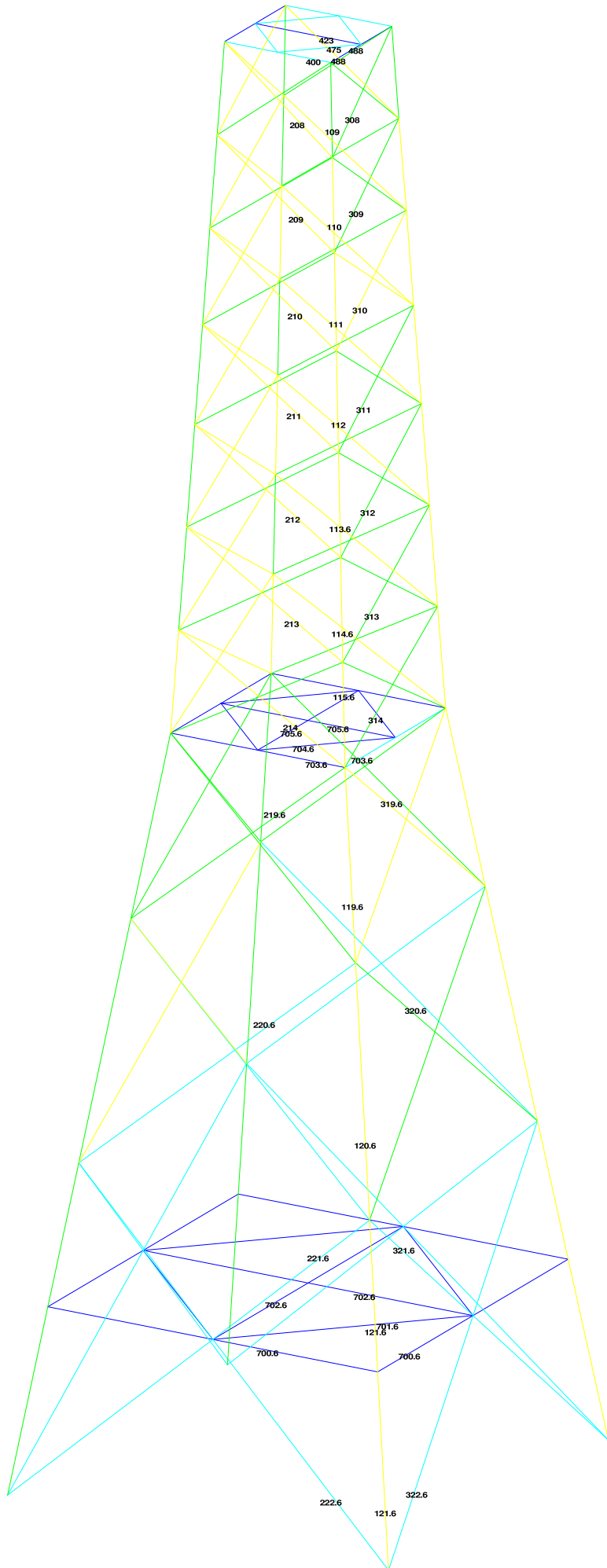

1 (m)

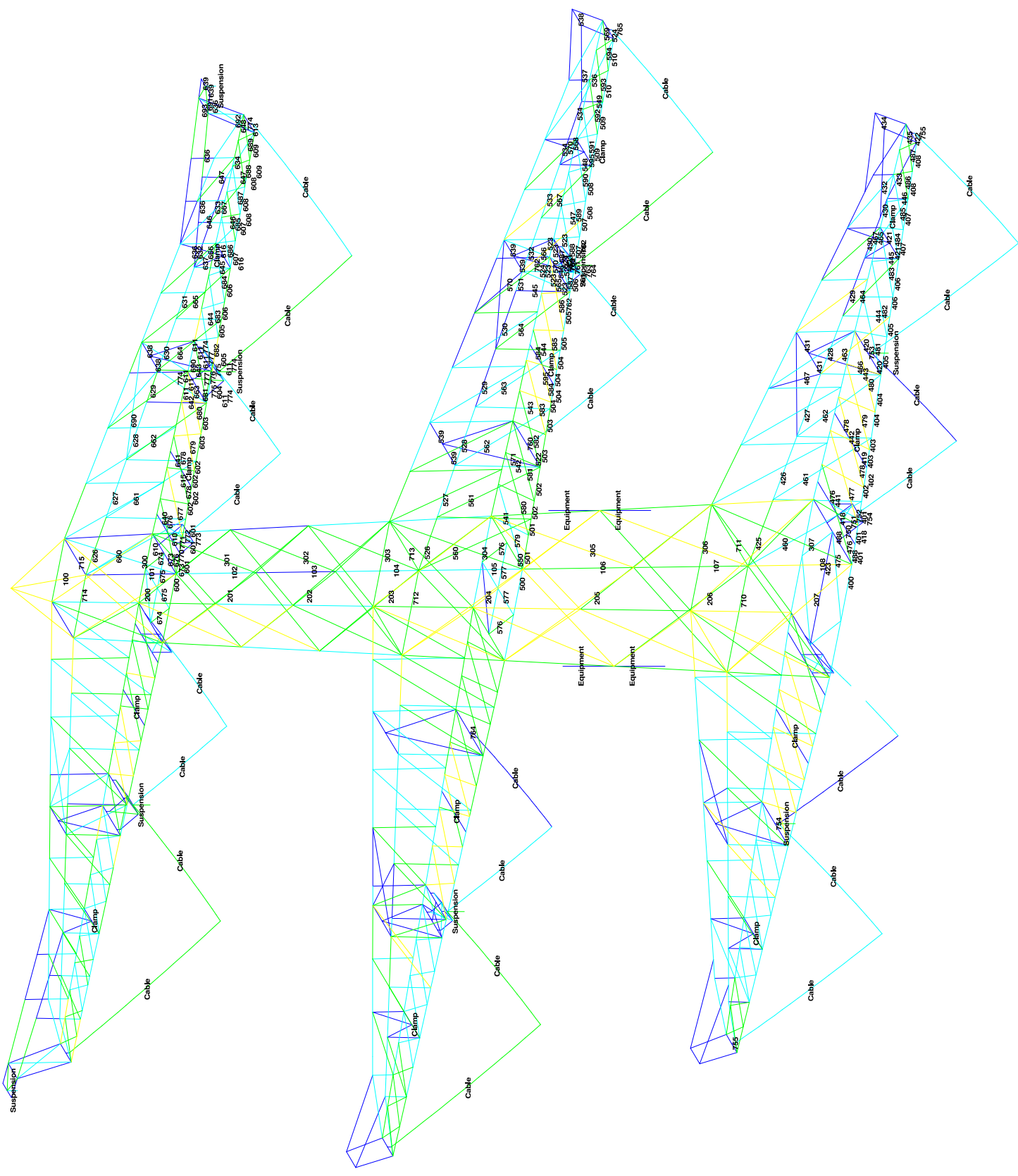



Assessment of angle groups - Lower structure

Date 5/4/2021
Author TBR
Version 1.0

RLL-TLB
S+12_c(full_summary)

Table with columns: Group Label, Description, Type, S1, S2, S3, S4, S5, S6, S7, S8, S9, S10, S11, S12, S13, S14, S15, S16, S17, S18, S19, S20, S21, S22, S23, S24, S25, S26, S27, S28, S29, S30, S31, S32, S33, S34, S35, S36, S37, S38, S39, S40, S41, S42, S43, S44, S45, S46, S47, S48, S49, S50, S51, S52, S53, S54, S55, S56, S57, S58, S59, S60, S61, S62, S63, S64, S65, S66, S67, S68, S69, S70, S71, S72, S73, S74, S75, S76, S77, S78, S79, S80, S81, S82, S83, S84, S85, S86, S87, S88, S89, S90, S91, S92, S93, S94. Rows contain detailed structural analysis data for various components like beam mid ca, lower chord mid ca, and upper chord mid ca.

APPENDIX C

Knikverkorters

Niet in PLS-TOWER gemodelleerde elementen in de constructie worden aanvullend getoetst. Hieronder vallen de knikverkorters van de randstijl en profielen onderdeel van stabiliteitsverbanden. De staven worden getoetst op:

- voldoende trek- of druksterkte als steungevend profiel voor randstijl, 1% van de knikcapaciteit van de randstijl;
- slankheid;
- klimbelasting

Voor de beloopbaarheid zijn staven in de traverse aanwezig. Deze zijn niet constructief (voorzien van slobgaten) en worden enkel getoetst op de klimbelasting van 1,0 kN. Zie hoofdstuk 4.2.5 en 5.7.2. van het uitgangspuntenrapport.

De knikverkorters van het tussenstuk en bovenstuk zijn voor alle masttypen in de groep van combi-steunmasten gelijk. Om deze reden worden alléén voor masttype S+12/c de knikverkorters van het bovenstuk en het onderstuk en de stapstaven in de traverse getoetst. Voor de overige masttypen worden alleen de knikverkorters van het onderstuk getoetst.

Profielen uit horizontaalverbanden van het onderstuk zijn in PLS-TOWER aanwezig maar worden in deze Appendix aanvullend getoetst op buiging. Profielafmeting en boutverbinding uit PLS-TOWER is leidend.

Overzicht knikverkorters - S-3/c

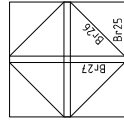
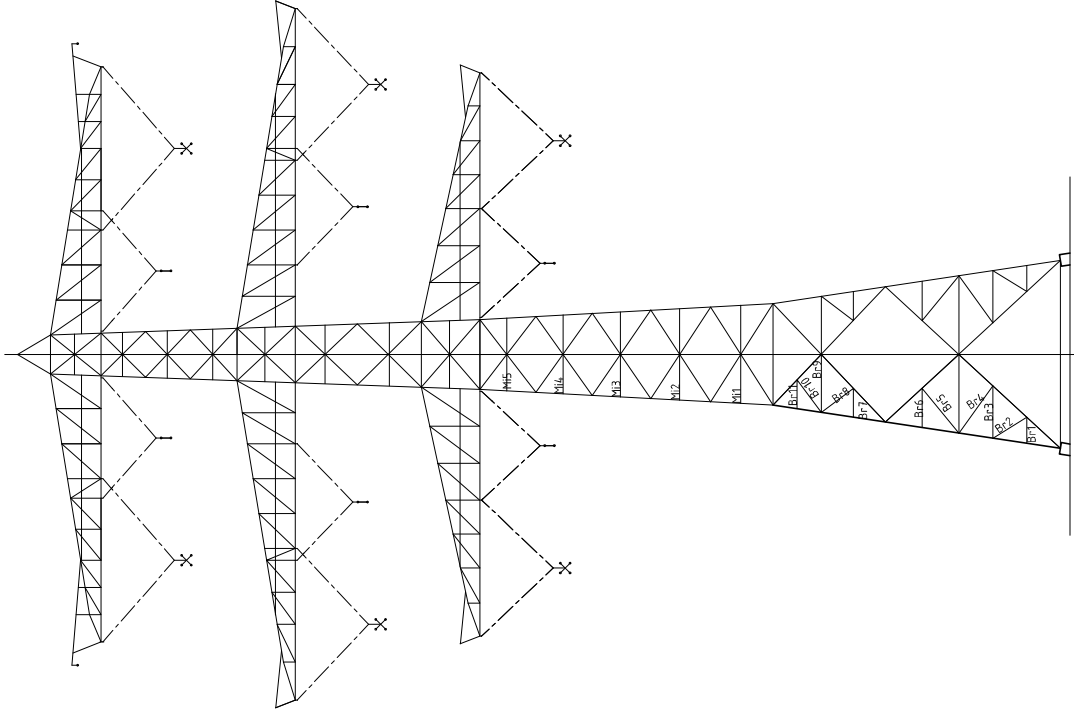

Tussenschot +15,3m

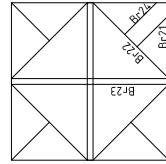

Tussenschot +5,73m



Redundant members

Date: 2021-07-27
 Author: TBR
 Version: 1.9

RLI-TLB
 S-3_c

Posnr.	Section	Schematization	Profile	Steel Quality	Bolt Quality	Length (m)	Angle (°)	Slenderness	Normal Force (kN)	Moment (kNm)	Buckling Cap. (kN)	Shear Cap. Bolt (kN)	Bearing Cap. (kN)	Net Section Cap. (kN)	Moment Cap. (kNm)	Highest U.C.	Max. usage	Notes
Br1	Broekstuk	Enkele staaf	L50x5	S355J0	M16	8.8	1.49	0	153	20.1	0.56	36.1	60.3	41.3	43.1	0.81	0.71	Bending
Br2	Broekstuk	Enkele staaf	L50x5	S355J0	M16	8.8	2.06	58	212	20.1	0.00	22.4	60.3	41.3	43.1	0.81	0.90	Buckling
Br3	Broekstuk	Enkele staaf	L70x6	S355J0	M16	8.8	2.93	0	214	20.1	1.10	37.4	60.3	52.3	122.3	1.99	0.58	Bending
Br4	Broekstuk	Enkele staaf	L70x6	S355J0	M16	8.8	3.15	36	230	20.1	0.00	33.4	60.3	52.3	122.3	1.99	0.60	Buckling
Br5	Broekstuk	Enkele staaf	L70x6	S355J0	M16	8.8	3.09	39	225	22.1	0.00	34.5	60.3	52.3	122.3	1.99	0.64	Buckling
Br6	Broekstuk	Enkele staaf	L60x6	S355J0	M16	8.8	2.18	0	187	22.1	0.82	39.0	60.3	52.3	98.8	1.40	0.60	Bending
Br7	Broekstuk	Enkele staaf	L50x5	S355J0	M16	8.8	1.67	0	172	22.1	0.63	30.6	60.3	41.3	43.1	0.81	0.80	Bending
Br8	Broekstuk	Enkele staaf	L50x5	S355J0	M16	8.8	2.15	53	221	20.5	0.00	21.0	60.3	41.3	43.1	0.81	0.98	Buckling
Br9	Broekstuk	Enkele staaf	L70x6	S355J0	M16	8.8	3.33	0	243	20.5	1.25	30.5	60.3	52.3	122.3	1.99	0.67	Buckling
Br10	Broekstuk	Enkele staaf	L60x6	S355J0	M16	8.8	2.23	36	191	20.5	0.00	37.7	60.3	52.3	98.8	1.40	0.54	Buckling
Br11	Broekstuk	Enkele staaf	L50x5	S355J0	M16	8.8	1.66	0	171	20.5	0.62	30.9	60.3	41.3	43.1	0.81	0.79	Bending
Br21	Tussenschot +5,06m	Enkele staaf	L90x8	S355J0	M16	8.8	4.05	0	230	22.1	1.52	57.0	60.3	69.7	225.8	4.34	0.39	Buckling
Br22	Tussenschot +5,06m	Kniksteun op 0,5L	L80x8	S355J0	M16	8.8	5.75	0	237	22.1	2.16	40.8	60.3	69.7	194.4	4.46	0.54	Buckling
Br23	Tussenschot +5,06m	Kruisende staaf halverwege	L90x8	S355J0	M16	8.8	8.10	0	230	22.1	1.52	57.0	60.3	69.7	225.8	5.70	0.39	Buckling
Br24	Tussenschot +5,06m	Enkele staaf	L60x6	S355J0	M16	8.8	2.88	0	246	22.1	1.08	25.4	60.3	52.3	98.8	1.40	0.87	Buckling
Br25	Tussenschot +14,6m	Enkele staaf	L110x10	S355J0	M16	8.8	2.62	0	121	20.5	0.98	214.4	60.3	87.1	360.6	8.04	0.34	shear
Br26	Tussenschot +14,6m	Enkele staaf	L80x6	S355J0	M16	8.8	3.71	0	236	20.5	1.39	36.7	60.3	52.3	145.8	2.68	0.56	Buckling
Br27	Tussenschot +14,6m	Kruisende staaf halverwege	L60x6	S355J0	M16	8.8	5.23	0	224	20.5	0.98	29.6	60.3	52.3	98.8	1.88	0.69	Buckling

Overzicht knikverkorters - S+0/c

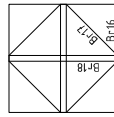
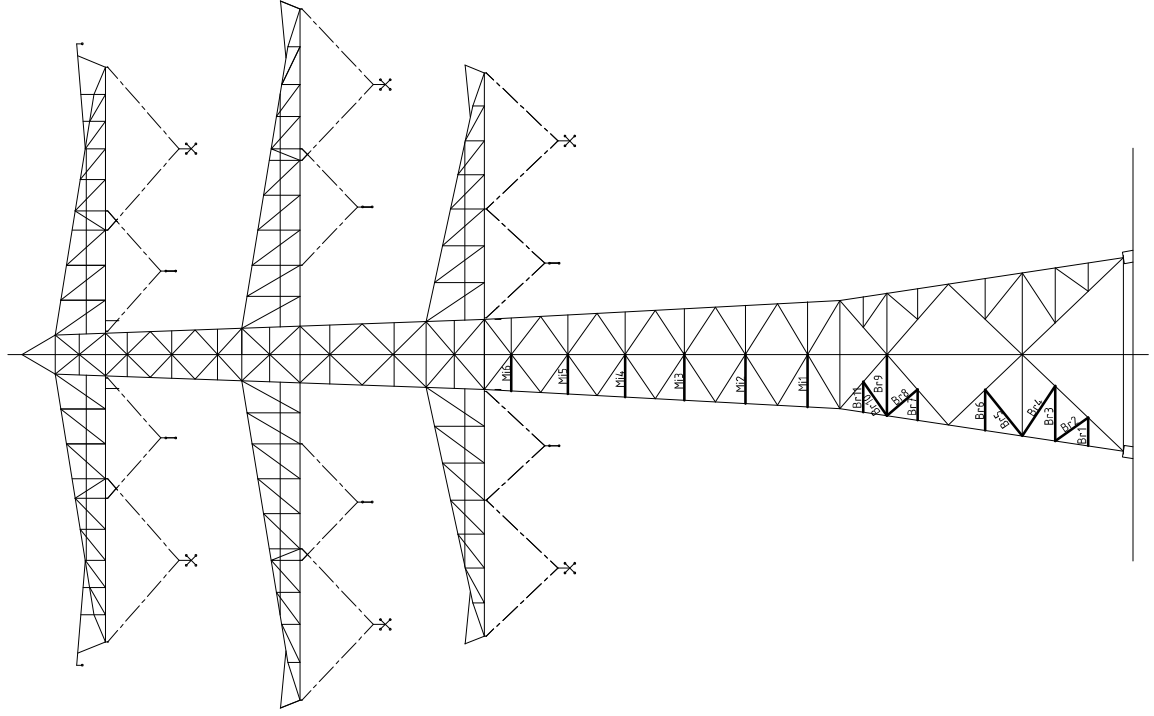

Tussenschot +14,5m

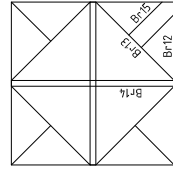

Tussenschot +5,7m



Redundant members

Date: 2021/05/05
 Author: TBR
 Version: 1.9

RLL-TLB
 S+0_C

Posnr.	Section	Schematization	Profile	Steel Quality	Bolt Quality	Length (m)	Angle (°)	Sfender ness	Normal Force (kN)	Moment (kNm)	Buckling Cap. (kN)	Shear Cap. Bolt (kN)	Bearing Cap. (kN)	Net Section Cap. (kN)	Moment Cap. (kNm)	Highest U.C.	Max. usage	Notes
Br1	Broekstuk	Enkele staaf	L50x5	S355J0 M16	8.8	1.45	0	149	22.0	0.54	37.3	60.3	41.3	43.1	0.81	0.69	Bending	
Br2	Broekstuk	Enkele staaf	L50x5	S355J0 M16	8.8	2.08	55	214	22.0	0.00	22.1	60.3	41.3	43.1	0.81	1.00	Buckling	
Br3	Broekstuk	Enkele staaf	L60x6	S355J0 M16	8.8	2.82	0	241	22.0	1.06	26.2	60.3	52.3	98.8	1.40	0.84	Buckling	
Br4	Broekstuk	Enkele staaf	L70x6	S355J0 M16	8.8	3.08	41	225	22.0	0.00	34.6	60.3	52.3	122.3	1.99	0.64	Buckling	
Br5	Broekstuk	Enkele staaf	L70x6	S355J0 M16	8.8	3.05	39	222	22.0	0.00	35.1	60.3	52.3	122.3	1.99	0.63	Buckling	
Br6	Broekstuk	Enkele staaf	L70x6	S355J0 M16	8.8	2.10	0	196	22.0	0.79	33.1	60.3	51.5	75.3	1.15	0.71	Bending	
Br7	Broekstuk	Enkele staaf	L50x5	S355J0 M16	8.8	1.58	0	162	22.0	0.59	33.2	60.3	41.3	43.1	0.81	0.76	Bending	
Br8	Broekstuk	Enkele staaf	L55x6	S355J0 M16	8.8	2.07	41	193	22.0	0.00	33.8	60.3	51.5	75.3	1.15	0.65	Buckling	
Br9	Broekstuk	Enkele staaf	L70x6	S355J0 M16	8.8	3.15	0	230	22.0	1.18	33.3	60.3	52.3	122.3	1.99	0.66	Buckling	
Br10	Broekstuk	Enkele staaf	L55x6	S355J0 M16	8.8	2.13	35	199	22.0	0.00	32.4	60.3	51.5	75.3	1.15	0.68	Buckling	
Br11	Broekstuk	Enkele staaf	L50x5	S355J0 M16	8.8	1.57	0	161	22.0	0.59	33.5	60.3	41.3	43.1	0.81	0.75	Bending	
Br12	Tussenschot +5,06m	Enkele staaf	L90x8	S355J0 M16	8.8	4.20	0	238	22.0	1.58	53.8	60.3	69.7	225.8	4.34	0.41	Buckling	1
Br13	Tussenschot +5,06m	Kniksteun op 0,5L	L90x8	S355J0 M16	8.8	5.88	0	243	22.0	2.21	39.5	60.3	69.7	194.4	4.46	0.56	Buckling	1
Br14	Tussenschot +5,06m	Kruisende staaf halverwege	L90x8	S355J0 M16	8.8	8.40	0	238	22.0	1.58	53.8	60.3	69.7	225.8	5.70	0.41	Buckling	1
Br15	Tussenschot +5,06m	Enkele staaf	L70x6	S355J0 M16	8.8	2.94	0	214	2.0	1.10	37.2	60.3	52.3	122.3	1.99	0.58	Bending	
Br16	Tussenschot +14,5m	Kniksteun op 0,5L	L110x10	S355J0 M16	8.8	5.57	0	166	22.0	2.09	115.4	60.3	87.1	360.6	10.69	0.36	shear	1
Br17	Tussenschot +14,5m	Enkele staaf	L80x6	S355J0 M16	8.8	3.90	0	248	22.0	1.46	34.0	60.3	52.3	145.8	2.68	0.65	Buckling	1
Br18	Tussenschot +14,5m	Kruisende staaf halverwege	L80x6	S355J0 M16	8.8	5.57	0	177	22.0	1.04	57.0	60.3	52.3	145.8	3.40	0.42	Bearing	1

1) Also checked in PLS - Tower

Overzicht knikverkorters - S+3/c

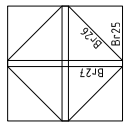
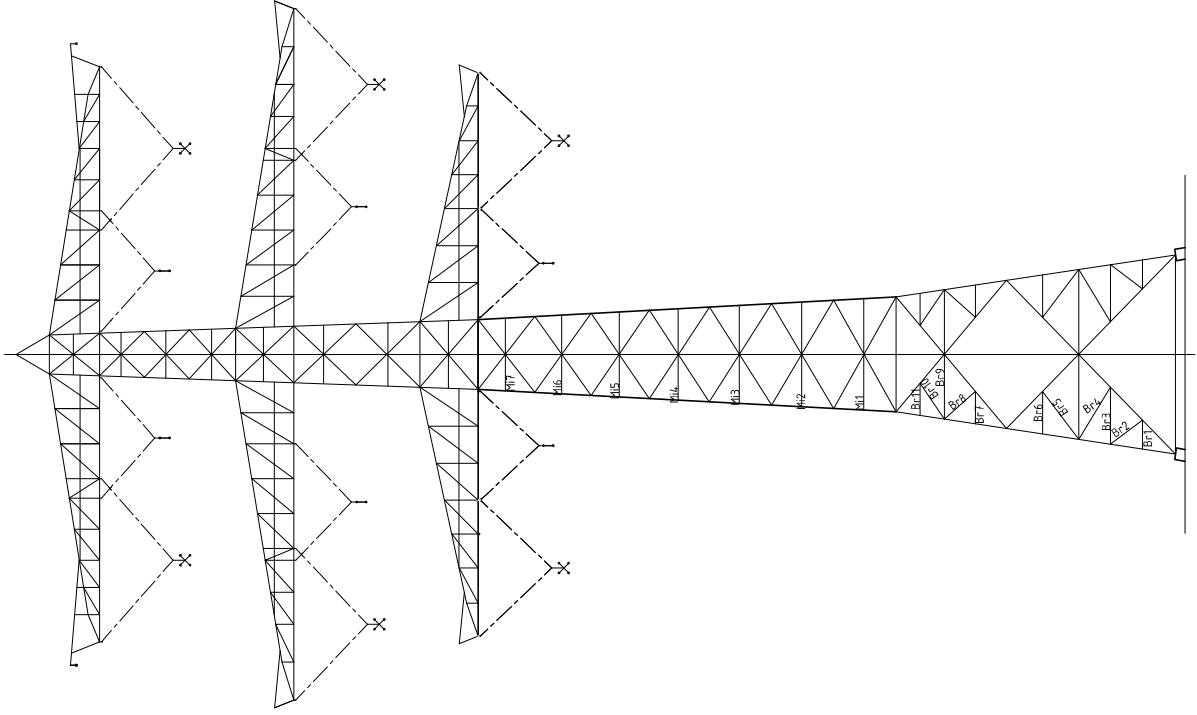

Tussenschot +14,9m

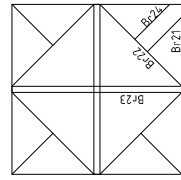

Tussenschot +5,45m



Redundant members

Date: 2021/05/05
 Author: TBR
 Version: 1.9

RLL-TLB
 S+3_C

Posnr.	Section	Schematization	Profile	Steel Quality	Bolt Quality	Length (m)	Angle (°)	Sfender ness	Normal Force (kN)	Moment (kNm)	Buckling Cap. (kN)	Shear Cap. Bolt (kN)	Bearing Cap. (kN)	Net Section Cap. (kN)	Moment Cap. (kNm)	Highest U.C.	Max. usage	Notes
Br1	Broekstuk	Enkele staaf	L50x5	S355J0 M16	8.8	1.49	0	153	20.1	0.56	36.1	60.3	41.3	43.1	0.81	0.71	Bending	
Br2	Broekstuk	Enkele staaf	L50x5	S355J0 M16	8.8	2.06	53	212	20.1	0.00	22.4	60.3	41.3	43.1	0.81	0.90	Buckling	
Br3	Broekstuk	Enkele staaf	L70x6	S355J0 M16	8.8	2.93	0	214	20.1	1.10	37.4	60.3	52.3	122.3	1.99	0.58	Bending	
Br4	Broekstuk	Enkele staaf	L70x6	S355J0 M16	8.8	3.15	31	230	20.1	0.00	33.4	60.3	52.3	122.3	1.99	0.60	Buckling	
Br5	Broekstuk	Enkele staaf	L70x6	S355J0 M16	8.8	3.09	0	225	22.1	1.16	34.5	60.3	52.3	122.3	1.99	0.64	Buckling	
Br6	Broekstuk	Enkele staaf	L60x6	S355J0 M16	8.8	2.18	0	187	22.1	0.82	39.0	60.3	52.3	98.8	1.40	0.60	Bending	
Br7	Broekstuk	Enkele staaf	L50x5	S355J0 M16	8.8	1.67	48	172	22.1	0.00	30.6	60.3	41.3	43.1	0.81	0.72	Buckling	
Br8	Broekstuk	Enkele staaf	L60x6	S355J0 M16	8.8	2.15	0	184	20.5	0.81	39.9	60.3	52.3	98.8	1.40	0.59	Bending	
Br9	Broekstuk	Enkele staaf	L70x6	S355J0 M16	8.8	3.33	34	243	20.5	0.00	30.5	60.3	52.3	122.3	1.99	0.67	Buckling	
Br10	Broekstuk	Enkele staaf	L60x6	S355J0 M16	8.8	2.23	0	191	20.5	0.84	37.7	60.3	52.3	98.8	1.40	0.62	Bending	
Br11	Broekstuk	Enkele staaf	L50x5	S355J0 M16	8.8	1.66	0	171	20.5	0.62	30.9	60.3	41.3	43.1	0.81	0.78	Bending	
Br21	Tussenschot +5,06m	Enkele staaf	L50x8	S355J0 M16	8.8	4.37	0	248	22.1	1.64	50.5	60.3	69.7	225.8	4.34	0.44	Buckling	1
Br22	Tussenschot +5,06m	Kniksteun op 0,5L	L90x8	S355J0 M16	8.8	6.21	0	226	22.1	2.33	49.3	60.3	69.7	225.8	5.70	0.45	Buckling	1
Br23	Tussenschot +5,06m	Kruisende staaf halverwege	L90x8	S355J0 M16	8.8	8.74	0	248	22.1	1.64	50.5	60.3	69.7	225.8	5.70	0.44	Buckling	1
Br24	Tussenschot +5,06m	Enkele staaf	L70x6	S355J0 M16	8.8	3.10	0	226	22.1	1.16	34.2	60.3	52.3	122.3	1.99	0.65	Buckling	
Br25	Tussenschot +14,6m	Enkele staaf	L120x10	S355J0 M16	8.8	3.33	0	140	20.5	1.25	195.9	60.3	87.1	399.8	9.77	0.34	shear	1
Br26	Tussenschot +14,6m	Enkele staaf	L100x8	S355J0 M16	8.8	4.73	0	240	20.5	1.77	59.3	60.3	69.7	257.2	5.49	0.35	Buckling	1
Br27	Tussenschot +14,6m	Kruisende staaf halverwege	L70x6	S355J0 M16	8.8	6.66	0	243	20.5	1.25	30.6	60.3	52.3	122.3	2.58	0.67	Buckling	1
M11	Middenstuk1	Enkele staaf	L60x6	S355J0 M16	8.8	2.89	0	247	19.1	1.08	25.2	60.3	52.3	98.8	1.4	0.80	Bending	

1) Also checked in PLS-TOWER

Overzicht knikverkorters - S+6/c

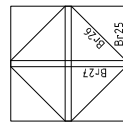
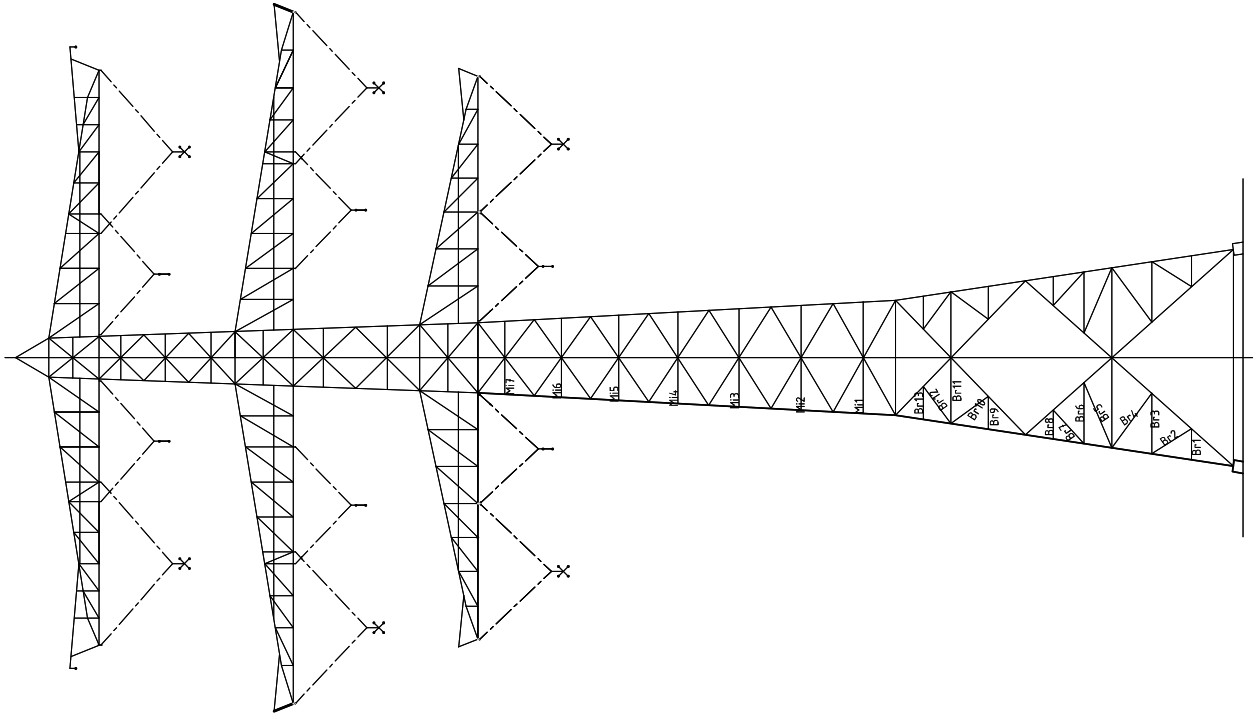

Tussenschot +17,9m

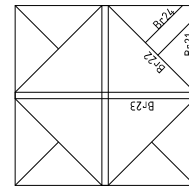

Tussenschot +6,75m



Redundant members

RLL-TLB
S+6_C

Date: 2021/05/05
Author: TBR
Version: 1.9

Posnr.	Section	Schematization	Profile	Steel Quality	Bolt Quality	Length (m)	Angle (°)	Sfender ness	Normal Force (kN)	Moment (kNm)	Buckling Cap. (kN)	Shear Cap. Bolt (kN)	Bearing Cap. (kN)	Net Section Cap. (kN)	Moment Cap. (kNm)	Highest U.C.	Max. usage	Notes
Br1	Broekstuk	Enkele staaf	L50x5	S355J0	M16	8.8	1.59	0	164	20.1	0.60	32.8	60.3	41.3	43.1	0.81	0.76	Bending
Br2	Broekstuk	Enkele staaf	L60x6	S355J0	M16	8.8	2.42	58	207	20.1	0.00	33.3	60.3	52.3	98.8	1.40	0.60	Buckling
Br3	Broekstuk	Enkele staaf	L70x6	S355J0	M16	8.8	3.11	0	227	20.1	1.17	34.0	60.3	52.3	122.3	1.99	0.61	Bending
Br4	Broekstuk	Enkele staaf	L80x6	S355J0	M16	8.8	3.47	36	221	20.1	0.00	40.8	60.3	52.3	145.8	2.68	0.49	Buckling
Br5	Broekstuk	Enkele staaf	L80x6	S355J0	M16	8.8	3.65	23	232	22.1	1.26	37.8	60.3	52.3	145.8	2.68	0.59	Buckling
Br6	Broekstuk	Enkele staaf	L70x6	S355J0	M16	8.8	3.14	0	229	22.1	1.18	33.5	60.3	52.3	122.3	1.99	0.66	Buckling
Br7	Broekstuk	Enkele staaf	L60x6	S355J0	M16	8.8	2.34	43	200	22.1	0.00	35.1	60.3	52.3	98.8	1.40	0.63	Buckling
Br8	Broekstuk	Enkele staaf	L50x5	S355J0	M16	8.8	1.49	0	153	22.1	0.56	36.0	60.3	41.3	43.1	0.81	0.71	Bending
Br9	Broekstuk	Enkele staaf	L50x5	S355J0	M16	8.8	1.69	0	174	20.5	0.63	30.1	60.3	41.3	43.1	0.81	0.81	Bending
Br10	Broekstuk	Enkele staaf	L60x6	S355J0	M16	8.8	2.38	54	204	20.5	0.00	34.2	60.3	52.3	98.8	1.40	0.60	Buckling
Br11	Broekstuk	Enkele staaf	L70x6	S355J0	M16	8.8	3.39	0	247	20.5	1.27	29.7	60.3	52.3	122.3	1.99	0.69	Buckling
Br12	Broekstuk	Enkele staaf	L60x6	S355J0	M16	8.8	2.39	37	204	20.5	0.00	34.1	60.3	52.3	98.8	1.40	0.60	Buckling
Br13	Broekstuk	Enkele staaf	L50x5	S355J0	M16	8.8	1.69	0	174	20.5	0.64	30.0	60.3	41.3	43.1	0.81	0.81	Bending
Br21	Tussenschot	Enkele staaf	L100x8	S355J0	M16	8.8	4.63	0	235	22.1	1.74	61.3	69.7	257.2	5.49	0.37	shear	
Br22	Tussenschot +5,06m	Kniksteun op 0,5L	L90x8	S355J0	M16	8.8	6.57	0	240	22.1	2.47	45.3	60.3	69.7	225.8	5.70	0.49	Buckling
Br23	Tussenschot +5,06m	Kruisende staaf halverwege	L120x10	S355J0	M16	8.8	9.26	0	195	22.1	1.74	122.8	60.3	87.1	399.8	12.83	0.37	shear
Br24	Tussenschot +5,06m	Enkele staaf	L70x6	S355J0	M16	8.8	3.29	0	240	22.1	1.23	31.2	60.3	52.3	122.3	1.99	0.71	Buckling
Br25	Tussenschot +14,6m	Enkele staaf	L120x10	S355J0	M16	8.8	2.96	0	125	20.5	1.11	227.6	60.3	87.1	399.8	9.77	0.34	shear
Br26	Tussenschot +14,6m	Enkele staaf	L90x8	S355J0	M16	8.8	4.20	0	239	20.5	1.58	53.7	60.3	69.7	225.8	4.34	0.38	Buckling
Br27	Tussenschot +14,6m	Kruisende staaf halverwege	L70x6	S355J0	M16	8.8	5.92	0	216	20.5	1.11	36.8	60.3	52.3	122.3	2.58	0.56	Buckling
M11	Middenstuk1	Enkele staaf	L60x6	S355J0	M16	8.8	2.89	0	247	19.5	1.08	25.2	60.3	52.3	98.8	1.4	0.80	Bending

1) Also checked in PLS-TOWER

Overzicht knikverkofters - S+9/c

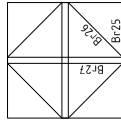
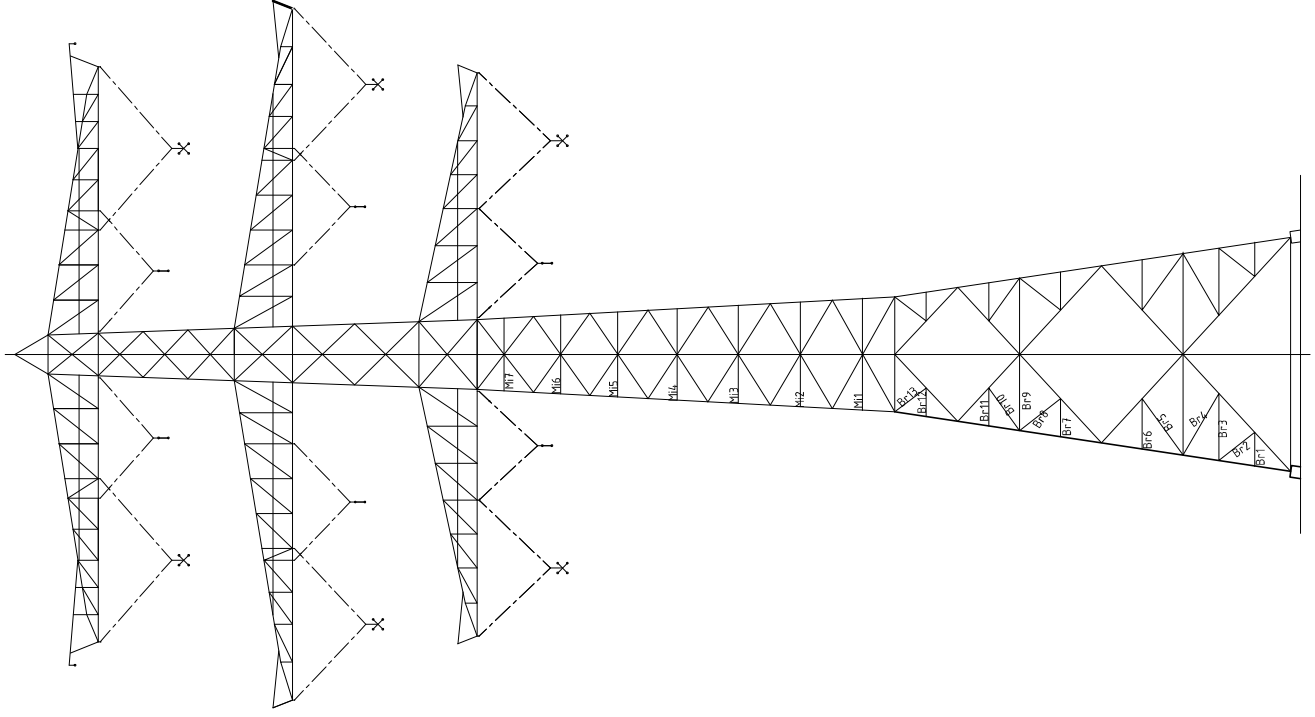

Tussenschot +20,9m

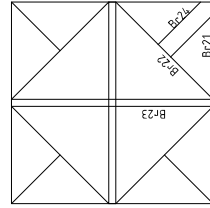

Tussenschot +6,04m



Redundant members

Date: 2021/05/05
 Author: TBR
 Version: 1.9

RLL-TLB
 S+9_C

Posnr.	Section	Schematization	Profile	Steel Quality	Bolt Quality	Length (m)	Angle (°)	Sfender ness	Normal Force (kN)	Moment (kNm)	Buckling Cap. (kN)	Shear Cap. Bolt (kN)	Bearing Cap. (kN)	Net Section Cap. (kN)	Moment Cap. (kNm)	Highest U.C.	Max. usage	Notes
Br1	Broekstuk	Enkele staaf	L50x5	S355J0 M16	8.8	1.76	0	181	23.3	0.66	28.4	60.3	41.3	43.1	0.81	0.84	Bending	
Br2	Broekstuk	Enkele staaf	L60x6	S355J0 M16	8.8	2.35	52	201	23.3	0.00	34.8	60.3	52.3	98.8	1.40	0.67	Buckling	
Br3	Broekstuk	Enkele staaf	L80x6	S355J0 M16	8.8	3.46	0	220	23.3	1.30	41.1	60.3	52.3	145.8	2.68	0.57	Buckling	
Br4	Broekstuk	Enkele staaf	L80x6	S355J0 M16	8.8	3.68	30	234	23.3	1.20	37.3	60.3	52.3	145.8	2.68	0.62	Buckling	
Br5	Broekstuk	Enkele staaf	L80x6	S355J0 M16	8.8	3.59	36	228	22.1	0.00	38.8	60.3	52.3	145.8	2.68	0.57	Buckling	
Br6	Broekstuk	Enkele staaf	L60x6	S355J0 M16	8.8	2.59	0	222	22.1	0.97	30.0	60.3	52.3	98.8	1.40	0.74	Buckling	
Br7	Broekstuk	Enkele staaf	L50x5	S355J0 M16	8.8	1.96	0	202	21.9	0.74	24.1	60.3	41.3	43.1	0.81	0.94	Bending	
Br8	Broekstuk	Enkele staaf	L60x6	S355J0 M16	8.8	2.67	52	229	21.9	0.00	28.5	60.3	52.3	98.8	1.40	0.77	Buckling	
Br9	Broekstuk	Enkele staaf	L80x6	S355J0 M16	8.8	3.93	0	250	21.9	1.47	33.6	60.3	52.3	145.8	2.68	0.65	Buckling	
Br10	Broekstuk	Enkele staaf	L60x6	S355J0 M16	8.8	2.72	36	233	21.9	0.00	27.8	60.3	52.3	98.8	1.40	0.79	Buckling	
Br11	Broekstuk	Enkele staaf	L50x5	S355J0 M16	8.8	1.96	0	202	21.9	0.74	24.1	60.3	41.3	43.1	0.81	0.94	Bending	
Br12	Broekstuk	Enkele staaf	L50x5	S355J0 M16	8.8	1.48	0	152	21.7	0.55	36.3	60.3	41.3	43.1	0.81	0.71	Bending	
Br13	Broekstuk	Enkele staaf	L50x5	S355J0 M16	8.8	2.04	53	210	21.7	0.00	22.7	60.3	41.3	43.1	0.81	0.95	Buckling	
Br21	Broekstuk	Enkele staaf	L110x10	S355J0 M16	8.8	5.19	0	241	23.3	1.95	80.6	60.3	87.1	360.6	8.04	0.39	shear	1
Br22	Tussenschot +5,06m	Kniksteun op 0,5L	L100x8	S355J0 M16	8.8	7.37	0	239	23.3	2.76	50.7	60.3	69.7	257.2	7.19	0.46	Buckling	1
Br23	Tussenschot +5,06m	Kruisende staaf halverwege	L110x10	S355J0 M16	8.8	10.38	0	241	23.3	1.95	80.6	60.3	87.1	360.6	10.69	0.39	shear	1
Br24	Tussenschot +5,06m	Enkele staaf	L80x6	S355J0 M16	8.8	3.68	0	234	23.3	1.38	37.2	60.3	52.3	145.8	2.68	0.63	Buckling	
Br25	Tussenschot +14,6m	Enkele staaf	L110x10	S355J0 M16	8.8	2.80	0	130	21.7	1.05	197.1	60.3	87.1	360.6	8.04	0.36	shear	1
Br26	Tussenschot +14,6m	Enkele staaf	L90x8	S355J0 M16	8.8	3.98	0	226	21.7	1.49	58.6	60.3	69.7	225.8	4.34	0.37	Buckling	1
Br27	Tussenschot +14,6m	Kruisende staaf halverwege	L70x6	S355J0 M16	8.8	5.60	0	204	21.7	1.05	40.1	60.3	52.3	122.3	2.58	0.54	Buckling	1
M11	Middenstuk1	Enkele staaf	L60x6	S355J0 M16	8.8	2.89	0	247	19.5	1.08	25.2	60.3	52.3	98.8	1.4	0.80	Bending	

1) Also checked in PLS-TOWER

Overzicht knikverkorters - S+12/c

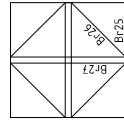
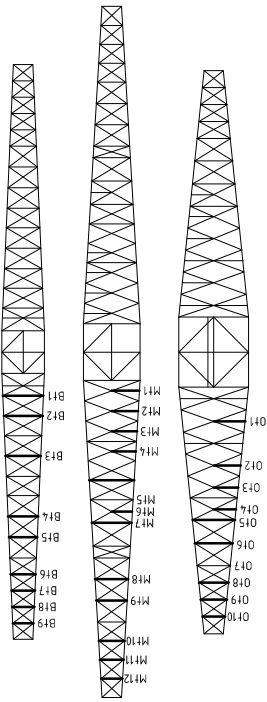

Tussenschot +23,9m

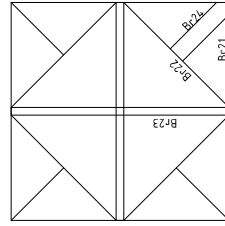

Tussenschot +6,28m

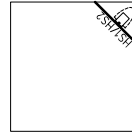

Standaard frame

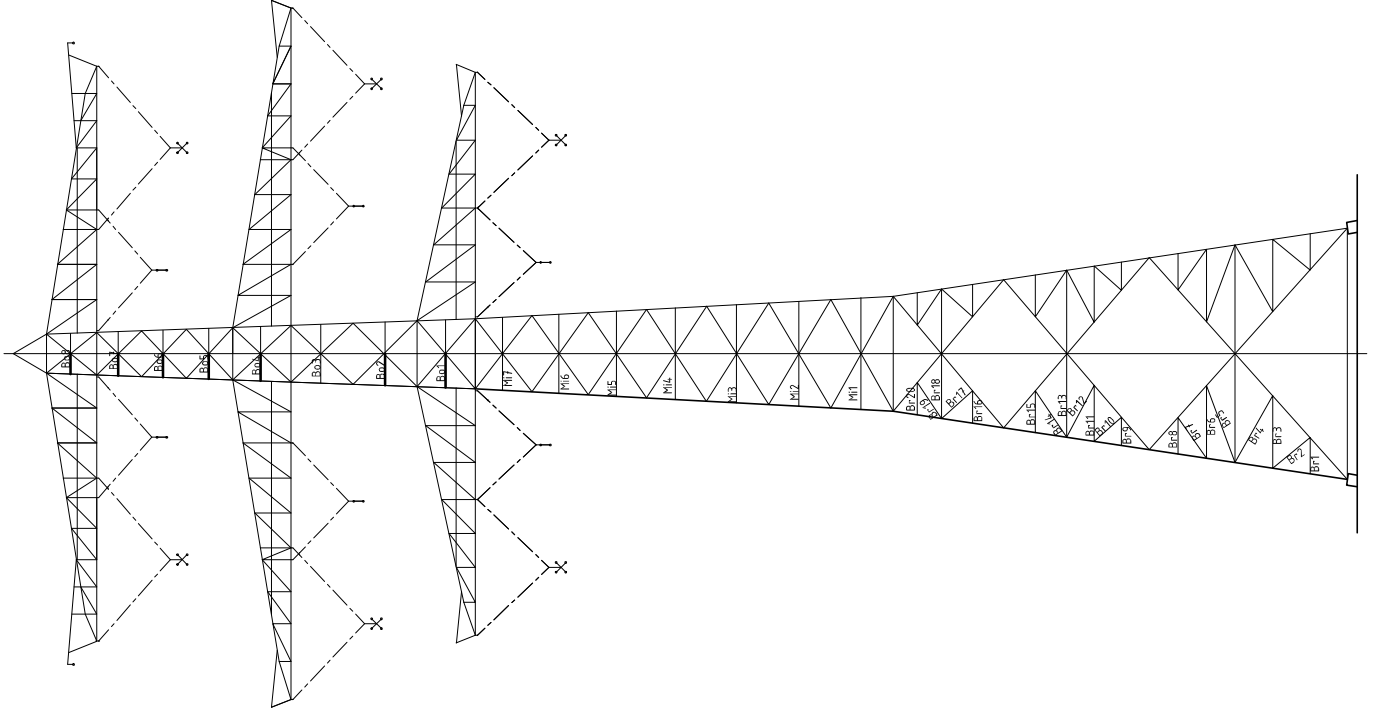



Redundant members

RLI-TLB
S+12_c

Date: 2021-07-27
Author: TBR
Version: 1.9

Posnr.	Section	Schematization	Profile	Steel Quality	Bolt Quality	Length (m)	Angle (°)	Slenderness	Normal Force (kN)	Moment (kNm)	Buckling Cap. (kN)	Shear Cap. (kN)	Bearing Cap. (kN)	Net Section Cap. (kN)	Moment Cap. (kNm)	Highest U.C.	Max. usage	Notes	
Br1	Broekstuk	Enkele staaf	L50x5	S355J0	M16	8.8	1.87	0	20.7	0.70	26.0	60.3	41.3	43.1	0.81	0.89	Bending		
Br2	Broekstuk	Enkele staaf	L60x6	S355J0	M16	8.8	2.49	51	20.7	1.40	31.9	60.3	52.3	52.3	98.8	1.40	0.65	Buckling	
Br3	Broekstuk	Enkele staaf	L80x6	S355J0	M16	8.8	3.73	0	20.7	1.40	36.4	60.3	52.3	145.8	2.68	0.57	Buckling		
Br4	Broekstuk	Enkele staaf	L90x6	S355J0	M16	8.8	3.95	29	22.2	0.00	43.7	60.3	52.3	169.3	3.48	0.45	Buckling		
Br5	Broekstuk	Enkele staaf	L90x6	S355J0	M16	8.8	4.22	20	22.2	0.00	41.1	60.3	52.3	145.8	3.48	0.54	Buckling		
Br6	Broekstuk	Enkele staaf	L80x6	S355J0	M16	8.8	3.74	0	22.2	1.40	36.4	60.3	52.3	145.8	2.68	0.61	Buckling		
Br7	Broekstuk	Enkele staaf	L60x6	S355J0	M16	8.8	2.56	35	22.2	0.79	30.6	60.3	52.3	98.8	1.40	0.73	Buckling		
Br8	Broekstuk	Enkele staaf	L50x5	S355J0	M16	8.8	1.87	0	22.2	0.00	25.9	60.3	41.3	43.1	0.81	0.86	Buckling		
Br9	Broekstuk	Enkele staaf	L50x5	S355J0	M16	8.8	1.45	0	21.6	0.54	37.3	60.3	41.3	43.1	0.81	0.69	Bending		
Br10	Broekstuk	Enkele staaf	L50x5	S355J0	M16	8.8	1.88	49	21.6	0.00	25.8	60.3	41.3	43.1	0.81	0.84	Buckling		
Br11	Broekstuk	Enkele staaf	L60x6	S355J0	M16	8.8	2.89	0	21.6	1.08	25.3	60.3	52.3	98.8	1.40	0.85	Buckling		
Br12	Broekstuk	Enkele staaf	L70x6	S355J0	M16	8.8	3.02	28	21.6	1.00	33.6	60.3	52.3	122.3	1.99	0.61	Buckling		
Br13	Broekstuk	Enkele staaf	L90x6	S355J0	M16	8.8	4.30	0	21.6	1.61	39.9	60.3	52.3	169.3	3.48	0.54	Buckling		
Br14	Broekstuk	Enkele staaf	L60x6	S355J0	M16	8.8	2.90	34	21.6	0.90	25.1	60.3	52.3	98.8	1.40	0.86	Buckling		
Br15	Broekstuk	Enkele staaf	L60x6	S355J0	M16	8.8	2.16	0	21.6	0.81	39.6	60.3	52.3	98.8	1.40	0.60	Bending		
Br16	Broekstuk	Enkele staaf	L50x5	S355J0	M16	8.8	1.67	0	21.6	0.63	30.7	60.3	41.3	43.1	0.81	0.80	Bending		
Br17	Broekstuk	Enkele staaf	L60x6	S355J0	M16	8.8	2.15	48	21.6	0.54	40.0	60.3	52.3	98.8	1.40	0.54	Buckling		
Br18	Broekstuk	Enkele staaf	L70x6	S355J0	M16	8.8	3.33	0	21.6	1.25	30.5	60.3	52.3	122.3	1.99	0.71	Buckling		
Br19	Broekstuk	Enkele staaf	L60x6	S355J0	M16	8.8	2.23	34	21.6	0.69	37.7	60.3	52.3	98.8	1.40	0.57	Buckling		
Br20	Broekstuk	Enkele staaf	L50x5	S355J0	M16	8.8	1.67	0	17.2	0.63	30.7	60.3	41.3	43.1	0.81	0.80	Bending		
Br21	Tussenschot +5,06m	Enkele staaf	L120x10	S355J0	M16	8.8	5.60	0	22.0	2.10	91.4	60.3	87.1	399.8	9.77	0.36	shear	1	
Br22	Tussenschot +5,06m	Kniksteun op 0,5L	L110x10	S355J0	M16	8.8	7.95	0	22.0	2.98	70.4	60.3	87.1	360.6	10.69	0.55	Buckling	1	
Br23	Tussenschot +5,06m	Kruisende staaf halverwegs	L70x6	S355J0	M16	8.8	5.60	0	22.0	1.05	40.1	60.3	52.3	122.3	2.58	0.81	0.95	Bending	1
Br24	Tussenschot +5,06m	Enkele staaf	L50x5	S355J0	M16	8.8	1.99	0	17.2	0.75	23.6	60.3	41.3	43.1	0.81	0.95	Bending	1	
Br25	Tussenschot +14,6m	Enkele staaf	L120x10	S355J0	M16	8.8	2.80	0	17.2	1.05	24.4	60.3	87.1	399.8	9.8	0.29	shear	1	
Br26	Tussenschot +14,6m	Enkele staaf	L90x8	S355J0	M16	8.8	3.98	0	17.2	1.49	56.6	60.3	69.7	225.8	4.3	0.36	Bending	1	
Br27	Tussenschot +14,6m	Kruisende staaf halverwegs	L50x5	S355J0	M16	8.8	2.80	0	17.2	0.53	39.2	60.3	41.3	43.1	1.1	0.48	Bending	1	
M1	Middenstuk1	Enkele staaf	L60x6	S355J0	M16	8.8	2.70	0	19.0	1.01	28.1	60.3	52.3	98.8	1.4	0.75	Bending		
M2	Middenstuk1	Enkele staaf	L55x6	S355J0	M16	8.8	2.52	0	19.0	0.95	24.9	60.3	51.5	75.3	1.2	0.85	Bending		
M3	Middenstuk1	Enkele staaf	L55x6	S355J0	M16	8.8	2.36	0	19.0	0.89	27.7	60.3	51.5	75.3	1.2	0.79	Bending		
M4	Middenstuk2	Enkele staaf	L50x5	S355J0	M16	8.8	2.19	0	14.0	0.82	31.1	60.3	51.5	75.3	1.2	0.73	Bending		
M5	Middenstuk2	Enkele staaf	L50x5	S355J0	M16	8.8	2.03	0	14.0	0.76	22.9	60.3	41.3	43.1	0.8	0.97	Bending		
M6	Middenstuk2	Enkele staaf	L50x5	S355J0	M16	8.8	1.88	0	14.0	0.71	25.7	60.3	41.3	43.1	0.8	0.90	Bending		
Bo1	Bovenstuk1	Enkele staaf	L50x5	S355J0	M16	8.8	1.74	0	14.0	0.65	28.8	60.3	41.3	43.1	0.8	0.83	Bending		
Bo2	Bovenstuk1	Enkele staaf	L50x5	S355J0	M16	8.8	1.63	0	11.3	0.61	31.8	60.3	41.3	43.1	0.8	0.78	Bending		
Bo3	Bovenstuk1	Enkele staaf	L50x5	S355J0	M16	8.8	1.51	0	11.3	0.57	35.4	60.3	41.3	43.1	0.8	0.72	Bending		
Bo4	Bovenstuk1	Enkele staaf	L50x5	S355J0	M16	8.8	1.40	0	11.3	0.53	39.0	60.3	41.3	43.1	0.8	0.67	Bending		
Bo5	Bovenstuk2	Enkele staaf	L50x5	S355J0	M16	8.8	1.30	0	3.8	0.49	43.0	60.3	41.3	43.1	0.8	0.62	Bending		
Bo6	Bovenstuk2	Enkele staaf	L50x5	S355J0	M16	8.8	1.21	0	3.8	0.45	47.1	60.3	41.3	43.1	0.8	0.58	Bending		
Bo7	Bovenstuk2	Enkele staaf	L50x5	S355J0	M16	8.8	1.13	0	3.8	0.42	51.1	60.3	41.3	43.1	0.8	0.54	Bending		
Bo8	Bovenstuk2	Enkele staaf	L50x5	S355J0	M16	8.8	1.05	0	3.8	0.42	56.0	60.3	41.3	43.1	0.8	0.50	Bending		
O1	Onderraverse	Enkele staaf	L50x5	S355J0	M16	8.8	1.61	0	3.3	0.60	32.3	60.3	41.3	43.1	0.8	0.77	Bending		
O2	Onderraverse	Enkele staaf	L50x5	S355J0	M16	8.8	1.39	0	3.3	0.52	39.5	60.3	41.3	43.1	0.8	0.66	Bending		
O3	Onderraverse	Enkele staaf	L60x6	S355J0	M16	8.8	1.26	0	3.3	0.47	50.3	60.3	52.3	98.8	1.4	0.35	Bending		
O4	Onderraverse	Enkele staaf	L50x5	S355J0	M16	8.8	1.15	0	3.3	0.43	50.2	60.3	41.3	43.1	0.8	0.55	Bending		
O5	Onderraverse	Enkele staaf	L55x6	S355J0	M16	8.8	2.20	0	20.5	0.83	30.8	60.3	41.3	43.1	0.8	0.94	Bending		
O6	Onderraverse	Enkele staaf	L50x5	S355J0	M16	8.8	1.95	0	3.3	0.73	24.4	60.3	41.3	43.1	0.8	0.93	Bending		
O7	Onderraverse	Enkele staaf	L50x5	S355J0	M16	8.8	1.72	0	3.3	0.65	29.4	60.3	41.3	43.1	0.8	0.82	Bending		



Redundant members

Date: 2021-07-27
 Author: TBR
 Version: 1.9

RLI-TLB
 S+12_c

Posnr.	Section	Schematization	Profile	Steel Quality	Bolt Quality	Length (m)	Angle (°)	Slenderness	Normal Force (kN)	Moment (kNm)	Buckling Cap. (kN)	Shear Cap. Bolt (kN)	Bearing Cap. (kN)	Net Section Cap. (kN)	Moment Cap. (kNm)	Highest U.C.	Max. usage	Notes
O8	Ondertaverse	Enkele staaf	L50x5	S355J0	M16	8.8	1.54	0	3.3	0.58	34.4	60.3	41.3	43.1	0.8	0.74	Bending	
O9	Ondertaverse	Enkele staaf	L50x5	S355J0	M16	8.8	1.35	0	3.3	0.51	41.1	60.3	41.3	43.1	0.8	0.65	Bending	
O10	Ondertaverse	Enkele staaf	L50x5	S355J0	M16	8.8	1.17	0	3.3	0.44	49.2	60.3	41.3	43.1	0.8	0.56	Bending	
M1	Ondertaverse	Enkele staaf	L50x5	S355J0	M16	8.8	1.46	0	3.3	0.55	37.0	60.3	41.3	43.1	0.8	0.70	Bending	
M2	Ondertaverse	Enkele staaf	L50x5	S355J0	M16	8.8	1.37	0	3.3	0.51	40.3	60.3	41.3	43.1	0.8	0.65	Bending	
M3	Middentaverse	Enkele staaf	L50x5	S355J0	M16	8.8	1.30	0	4.0	0.49	43.1	60.3	41.3	43.1	0.8	0.62	Bending	
M4	Middentaverse	Enkele staaf	L50x5	S355J0	M16	8.8	1.24	0	4.0	0.47	45.8	60.3	41.3	43.1	0.8	0.59	Bending	
M5	Middentaverse	Enkele staaf	L55x6	S355J0	M16	8.8	2.31	0	4.0	0.87	28.6	60.3	51.5	75.3	1.2	0.78	Bending	
M6	Middentaverse	Enkele staaf	L55x6	S355J0	M16	8.8	1.06	0	4.0	0.40	80.4	60.3	51.5	75.3	1.2	0.36	Bending	
M7	Middentaverse	Enkele staaf	L55x6	S355J0	M16	8.8	2.05	0	4.0	0.77	34.3	60.3	51.5	75.3	1.2	0.69	Bending	
M8	Middentaverse	Enkele staaf	L50x5	S355J0	M16	8.8	1.72	0	4.0	0.65	29.4	60.3	41.3	43.1	0.8	0.82	Bending	
M9	Middentaverse	Enkele staaf	L50x5	S355J0	M16	8.8	1.58	0	4.0	0.59	33.2	60.3	41.3	43.1	0.8	0.76	Bending	
M10	Middentaverse	Enkele staaf	L50x5	S355J0	M16	8.8	1.34	0	4.0	0.50	41.5	60.3	41.3	43.1	0.8	0.64	Bending	
M11	Middentaverse	Enkele staaf	L50x5	S355J0	M16	8.8	1.23	0	4.0	0.46	46.3	60.3	41.3	43.1	0.8	0.59	Bending	
M12	Middentaverse	Enkele staaf	L50x5	S355J0	M16	8.8	1.11	0	4.0	0.42	52.3	60.3	41.3	43.1	0.8	0.53	Bending	
B1	Boventraverse	Enkele staaf	L50x5	S355J0	M16	8.8	2.10	0	4.3	0.79	33.1	60.3	51.5	75.3	1.2	0.71	Bending	
B2	Boventraverse	Enkele staaf	L50x5	S355J0	M16	8.8	1.82	0	4.3	0.75	23.0	60.3	41.3	43.1	0.8	0.96	Bending	
B3	Boventraverse	Enkele staaf	L50x5	S355J0	M16	8.8	1.55	0	4.3	0.68	27.0	60.3	41.3	43.1	0.8	0.87	Bending	
B4	Boventraverse	Enkele staaf	L50x5	S355J0	M16	8.8	1.46	0	4.3	0.58	34.1	60.3	41.3	43.1	0.8	0.74	Bending	
B5	Boventraverse	Enkele staaf	L50x5	S355J0	M16	8.8	1.29	0	4.3	0.55	37.0	60.3	41.3	43.1	0.8	0.70	Bending	
B6	Boventraverse	Enkele staaf	L50x5	S355J0	M16	8.8	1.22	0	4.3	0.48	43.6	60.3	41.3	43.1	0.8	0.62	Bending	
B7	Boventraverse	Enkele staaf	L50x5	S355J0	M16	8.8	1.15	0	4.3	0.46	46.7	60.3	41.3	43.1	0.8	0.58	Bending	
B8	Boventraverse	Enkele staaf	L50x5	S355J0	M16	8.8	1.15	0	4.3	0.43	50.2	60.3	41.3	43.1	0.8	0.55	Bending	
B9	Boventraverse	Enkele staaf	L50x5	S355J0	M16	8.8	1.07	0	4.3	0.40	54.6	60.3	41.3	43.1	0.8	0.51	Bending	
H51	High Step	Enkele staaf	L80x6	S355J0	M16	8.8	3.25	0	20.7	2.44	45.2	60.3	52.3	145.8	2.7	0.95	Bending	
H52	High Step	Enkele staaf	L70x7	S355J0	M16	8.8	2.80	0	20.5	2.10	46.0	60.3	61.0	142.7	2.2	0.97	Bending	

1) Also checked in PLS-TOWER

APPENDIX D

Blokdeuvels

Belasting

De belastingen op de fundatie uit Appendix A zijn uitgangspunt voor de berekening van de ingestorte rand met blokdeuvels. De belastingen in de richting van de randstijl zijn van toepassing. In de tabellen is dit opgenomen in de laatste kolom $R_{z,lok}$. De controles zijn uitgevoerd met een spreadsheet. Vanwege de helling van de drukdiagonaal wordt per krachtrichting bepaald hoeveel deuvels effectief zijn.

Voor de berekening van de blokdeuvels zijn de masttypen als volgt samengevoegd:

- Masttype S-3/c en S+0/c
- Masttype S+3/c en S+6/c
- Masttype S+9/c en S+12/c

De blokdeuvels worden getoetst op de maatgevende belasting per samenvoeging van masttypen (hoogste mast is maatgevend). De belastingen waaraan getoetst worden zijn onderstaand weergegeven.

Masttype S-3/c en S+0/c

Omhullenden ongeacht stijl

Belasting	Combinatie	R_x [kN]	R_y [kN]	R_z [kN]	R_η [kN]	R_ξ [kN]	$R_{\xi,lok}$ [kN]	$R_{z,lok}$ [kN]
Max. druk	ULS 1a_90	291	234	1766	41	-371	3	1806
Max. trek	ULS 1a_0,9_0,9_90	-226	168	-1369	41	279	-12	-1400
Max. pos. torsie	ULS 5a Ah 21	45	-41	-15	61	-3	-6	-15
Max. neg. torsie	ULS 5a Ba 21	-45	-41	-15	-61	-3	-6	-15
Comb. trek+torsie	ULS 1a_0,9_0,9_90	-226	168	-1369	41	279	-12	-1400

Masttype S+3/c en S+6/c

Omhullenden ongeacht stijl

Belasting	Combinatie	R_x [kN]	R_y [kN]	R_z [kN]	R_η [kN]	R_ξ [kN]	$R_{\xi,lok}$ [kN]	$R_{z,lok}$ [kN]
Max. druk	ULS 1a_45	307	278	1909	21	-414	-9	1952
Max. trek	ULS 1a_0,9_0,9_45	238	209	-1491	-21	316	0	-1524
Max. pos. torsie	ULS 5a Ah 21	43	-36	-11	56	-4	-7	-11
Max. neg. torsie	ULS 5a Ba 21	-43	-36	-11	-56	-4	-7	-11
Comb. trek+torsie	ULS 1a_0,9_0,9_90	-245	184	-1483	43	303	-12	-1516

Masttype S+9/c en S+12/c

Omhullenden ongeacht stijl

Belasting	Combinatie	R_x [kN]	R_y [kN]	R_z [kN]	R_η [kN]	R_ξ [kN]	$R_{\xi,lok}$ [kN]	$R_{z,lok}$ [kN]
Max. druk	ULS 1a_45	329	303	2001	19	-447	-23	2045
Max. trek	ULS 1a_0,9_0,9_45	248	221	-1506	-19	332	12	-1540
Max. pos. torsie	ULS 5a Ah 21	43	-25	30	49	-13	-7	30
Max. neg. torsie	ULS 5a Ba 21	-43	-25	30	-49	-13	-7	30
Comb. trek+torsie	ULS 1a_0,9_0,9_90	-242	194	-1469	34	308	-3	-1501

Principe blokdeuvels - S+0/c & S-3/c

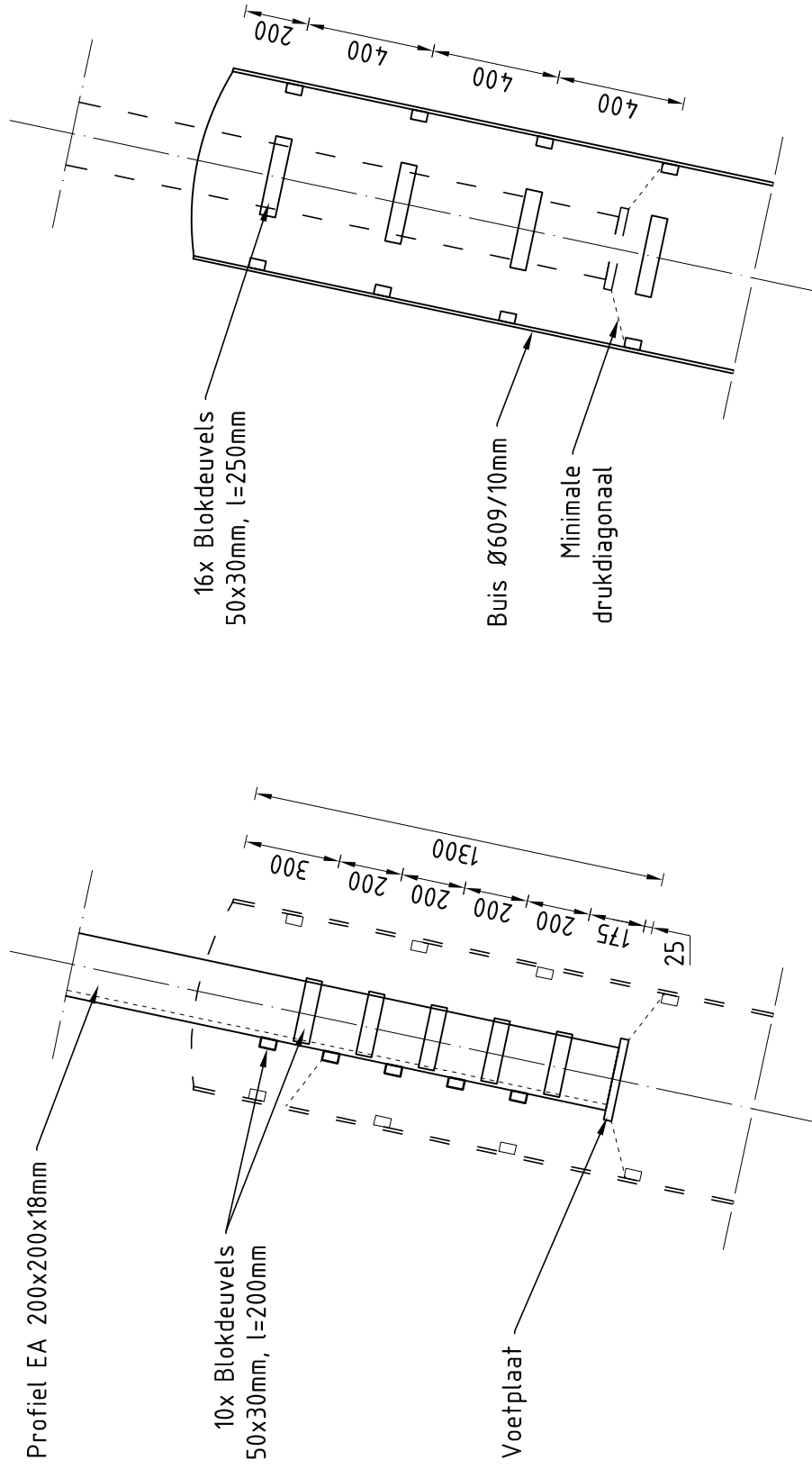

Algemene opmerkingen

- Aarding niet aangegeven
- Spiraalwapening niet aangegeven

Project: RLL-TBG
Mast: S-3/c & S+0/c

Shear blocks

NEN-EN 1993-1-1 en NEN-EN 1994-1-1

Datum: 2021-07-27

Auteur: TBR

Versie: 1.5

Load			Results		
Compression	$F_{Ed,c}$	1806 kN	Compression	U.C.	0,92 < 1,00 OK
Tension	$F_{Ed,t}$	1401 kN	Tension	U.C.	0,75 < 1,00 OK

Main leg

Profile		L200x18
Type		Single
Steel material		S355
Cross section		6911 mm ²
Axial capacity	N_{pl}	2453 kN
Width	b	200 mm
Thickness	t	18 mm
Length in concrete		1300 mm

Capacity shear blocks main leg

$A_{f1} = A_{f1,out} + A_{f1,in} =$	6000 mm ²
$A_{f2} = A_{f2,out} + A_{f2,in} =$	15400 mm ²
Slope	1 : 5
$C_A = \sqrt{A_{f2}/A_{f1}} =$	1,60
$f_{jd} = C_A \times f_{cd} =$	24,1 N/mm ²
$F_{Rd,c} = n_c \times A_{f1} \times f_{jd} =$	1156 kN
$F_{Rd,t} = n_t \times A_{f1} \times f_{jd} =$	1156 kN

Shear blocks main leg

Sides		1 (outside)
Width	b	50 mm
Thickness	h	30 mm
Length - outside	L_{out}	200 mm
Length - inside	L_{in}	mm
Eccentricity	e	-10 mm
Welds	a	5 mm
c.t.c. separation	s	200 mm
Number for compr.	n_c	8 -
Number for tension	n_t	8 -

Capacity foot plate

$K_d =$	1,73 -
$f_{jd} = C_A \times f_{cd} =$	26,0 N/mm ²
$c = t\sqrt{f_{yd} / 3f_{jd}} =$	53 mm
$m^* = \min(c, m) =$	30 mm
Type foot plate	Extending
Effective for	Compr. and tension
$A_{p,c} =$	34511 mm ²
$F_{Rd,c} = A_{p,druk} \times f_{jd} =$	899 kN
$A_{p,t} =$	27600 mm ²
$F_{Rd,t} = A_{p,t} \times f_{jd} =$	719 kN

Foot plate

Thickness	t	25 mm
Ext. length	m	30 mm
Welds	a	5 mm

Capacities

$F_{Rd,c,plate} =$	899 kN
$F_{Rd,blocks,c} =$	1156 kN
$F_{Rd,c} = F_{Rd,block} + F_{Rd,footplate} =$	2055 kN
U.C. compression	0,88 < 1,00 OK
Welds foot plate (see next page)	961 kN
$F_{Rd,t} = \min. (\text{welds} / \text{foot plate}) =$	719 kN
$F_{Rd,blocks,t} =$	1156 kN
$F_{Rd,t} = F_{Rd,block} + F_{Rd,footplate} =$	1875 kN
U.C. tension	0,75 < 1,00 OK
U.C. welds	0,44 < 1,00 OK

Pile

Name		Buispaal
Diameter		609 mm
Thickness		10 mm
Cross section		18818 mm ²
Steel material		S355
Capacity		6680 kN
Concrete strength		C30/37

Capacity shear blocks pile

$A_{f1} =$	7500 mm ²
$A_{f2} =$	28212 mm ²
$C_A = \sqrt{A_{f2}/A_{f1}} =$	1,94 -
$f_{jd} = K_d \times f_{cd} =$	29,2 N/mm ²
$F_{Rd,c} = n_c \times A_{f1} \times f_{jd} \times C_{red} =$	1969 kN
U.C. compression	0,92 < 1,00 OK
$F_{Rd,t} = n_t \times A_{f1} \times f_{jd} \times C_{red} =$	1969 kN
U.C. tension	0,71 < 1,00 OK
U.C. welds	0,44 < 1,00 OK

Shear blocks pile

Width	b	50 mm
Thickness	h	30 mm
Length	L	250 mm
Welds	a	5 mm
c.t.c. separation	s	350 mm
Number for compr.	n_c	12 -
Number for tension	n_t	12 -
Blocks per row	n_{bl}	4 -
Effectivity of total	C_{red}	75% -

Design value concrete strength

Material factor	γ_c	1,5
Add. mat. factor	γ_m	1,33 -
$f_{cd} =$		15,0 N/mm ²

"Splitting" of pile

Spread of forces		45 °
Length force flow		1006 mm
Splitting force		697 kN/m
Yield strength wall	$f_{yd} =$	355 N/mm ²
Capacity tubular pile		7100 kN/m
U.C.		0,10 < 1,00 OK

Steel tower stub

Yield strength	$f_{yd} =$	355 N/mm ²
Tensile strength	$f_{ud} =$	490 N/mm ²

Project: RLL-TBG
Mast: S-3/c & S+0/c

Welds of shear blocks of main leg

Out-of-plane loading

Plate

t = 50 mm
Grade S355
f_{yd} = 355 N/mm²
f_u = 490 N/mm²

Member forces

Factor 1,2
F_{t,Ed} = 0 kN
F_{v,Ed} = F_{Rd,c} / n = 173 kN
F_{v//,Ed} = 0 kN
M_{Ed} = 1/2 b / h x F_{v,Ed} = 2,60 kNm

Check

σ_{w,Ed} = 190 N/mm² ≤
σ₁ = 95 N/mm² ≤

Welds

a = 5 mm
l = 200 mm
β_w = 0,9 -
γ_{M2} = 1,25 -

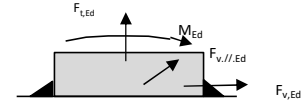

Stress components

σ₁ = τ₁ = F_{t,Ed} √2 / 4al = 0 N/mm²
σ₁ = τ₁ = F_{v,Ed} √2 / 4al = 61 N/mm²

61 N/mm²
b* = b + 2/3av² = 54,7 mm
σ₁ = τ₁ = 0,706M_{Ed} / al b* = 34 N/mm²
τ_{//} = F_{v//,Ed} / 2al = 0 N/mm²
σ_{w,Ed} = √(σ₁² + 3τ₁² + 3τ_{//}²) = 190 N/mm²

f_u / β_w γ_{M2} = 436 N/mm² U.C. = **0,44 OK**
0,9f_u / γ_{M2} = 353 N/mm² U.C. = **0,27 OK**

Welds of shear blocks of pile

Out-of-plane loading

Plate

t = 50 mm
Grade S355
f_{yd} = 355 N/mm²
f_u = 490 N/mm²

Member forces

Factor 1,2
F_{t,Ed} = 1/2 b / h x F_{v,Ed} = 79 kN
F_{v,Ed} = 262 kN
F_{v//,Ed} = 0 kN
M_{Ed} = 0,00 kNm

Check

σ_{w,Ed} = 193 N/mm² ≤
σ₁ = 97 N/mm² ≤

Welds

a = 5 mm
l = 250 mm
β_w = 0,9 -
γ_{M2} = 1,25 -

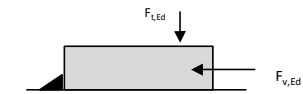

Stress components

σ₁ = τ₁ = F_{t,Ed} √2 / 2al = 22 N/mm²
σ₁ = τ₁ = F_{v,Ed} √2 / 2al = 74 N/mm²

97 N/mm²
τ_{//} = F_{v//,Ed} / 2al = 0 N/mm²
σ_{w,Ed} = √(σ₁² + 3τ₁² + 3τ_{//}²) = 193 N/mm²

f_u / β_w γ_{M2} = 436 N/mm² U.C. = **0,44 OK**
0,9f_u / γ_{M2} = 353 N/mm² U.C. = **0,27 OK**

Welds of foot plate

f_u / β_w γ_{M2} = 436 N/mm²
Weld size a = 5 mm
Length l = 2b + 2b - t = 764 mm
Capacity F_{Rd} = a x l x f_{w,d} / √3 = 961 kN

Principe blokdeuvels - S+3/c en S+6/c

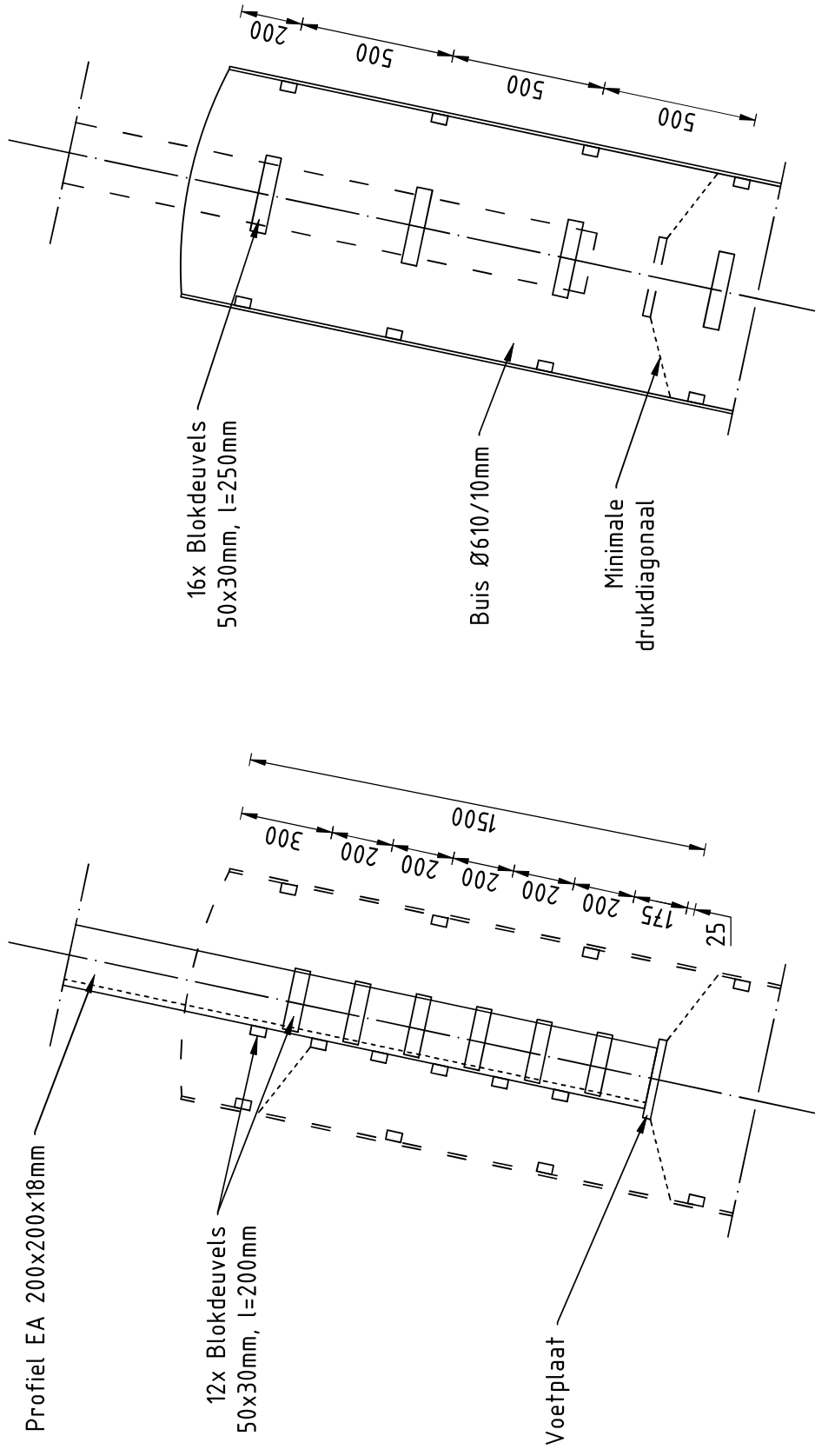

Algemene opmerkingen

- Aarding niet aangegeven
- Spiraalwapening niet aangegeven

Project: RLL-TBG
Mast: S+3/c & S+6/c

Shear blocks

NEN-EN 1993-1-1 en NEN-EN 1994-1-1

Datum: 2021-07-27

Auteur: TBR

Versie: 1.5

Load			Results		
Compression	$F_{Ed,c}$	1952 kN	Compression	U.C.	0,83 < 1,00 OK
Tension	$F_{Ed,t}$	1524 kN	Tension	U.C.	0,70 < 1,00 OK

Main leg

Profile		L200x18
Type		Single
Steel material		S355
Cross section		6911 mm ²
Axial capacity	N_{pl}	2453 kN
Width	b	200 mm
Thickness	t	18 mm
Length in concrete		1500 mm

Capacity shear blocks main leg

$A_{f1} = A_{f1,out} + A_{f1,in} =$	6000 mm ²
$A_{f2} = A_{f2,out} + A_{f2,in} =$	15400 mm ²
Slope	1 : 5
$C_A = \sqrt{A_{f2}/A_{f1}} =$	1,60
$f_{jd} = C_A \times f_{cd} =$	24,1 N/mm ²
$F_{Rd,c} = n_c \times A_{f1} \times f_{jd} =$	1445 kN
$F_{Rd,t} = n_t \times A_{f1} \times f_{jd} =$	1445 kN

Shear blocks main leg

Sides		1 (outside)
Width	b	50 mm
Thickness	h	30 mm
Length - outside	L_{out}	200 mm
Length - inside	L_{in}	mm
Eccentricity	e	-10 mm
Welds	a	5 mm
c.t.c. separation	s	200 mm
Number for compr.	n_c	10 -
Number for tension	n_t	10 -

Capacity foot plate

$K_d =$	1,73 -
$f_{jd} = C_A \times f_{cd} =$	26,0 N/mm ²
$c = t\sqrt{f_{yd} / 3f_{jd}} =$	53 mm
$m^* = \min(c, m) =$	30 mm
Type foot plate	Extending
Effective for	Compr. and tension
$A_{p,c} =$	34511 mm ²
$F_{Rd,c} = A_{p,druk} \times f_{jd} =$	899 kN
$A_{p,t} =$	27600 mm ²
$F_{Rd,t} = A_{p,t} \times f_{jd} =$	719 kN

Foot plate

Thickness	t	25 mm
Ext. length	m	30 mm
Welds	a	5 mm

Capacities

$F_{Rd,c,plate} =$	899 kN
$F_{Rd,blocks,c} =$	1445 kN
$F_{Rd,c} = F_{Rd,block} + F_{Rd,footplate} =$	2344 kN
U.C. compression	0,83 < 1,00 OK
Welds foot plate (see next page)	961 kN
$F_{Rd,t} = \min. (\text{welds} / \text{foot plate}) =$	719 kN
$F_{Rd,blocks,t} =$	1445 kN
$F_{Rd,t} = F_{Rd,block} + F_{Rd,footplate} =$	2164 kN
U.C. tension	0,70 < 1,00 OK
U.C. welds	0,44 < 1,00 OK

Pile

Name		Buispaal
Diameter		609 mm
Thickness		10 mm
Cross section		18818 mm ²
Steel material		S355
Capacity		6680 kN
Concrete strength		C30/37

Capacity shear blocks pile

$A_{f1} =$	7500 mm ²
$A_{f2} =$	41087 mm ²
$C_A = \sqrt{A_{f2}/A_{f1}} =$	2,34 -
$f_{jd} = K_d \times f_{cd} =$	35,2 N/mm ²
$F_{Rd,c} = n_c \times A_{f1} \times f_{jd} \times C_{red} =$	2376 kN
U.C. compression	0,82 < 1,00 OK
$F_{Rd,t} = n_t \times A_{f1} \times f_{jd} \times C_{red} =$	2376 kN
U.C. tension	0,64 < 1,00 OK
U.C. welds	0,53 < 1,00 OK

Shear blocks pile

Width	b	50 mm
Thickness	h	30 mm
Length	L	250 mm
Welds	a	5 mm
c.t.c. separation	s	500 mm
Number for compr.	n_c	12 -
Number for tension	n_t	12 -
Blocks per row	n_{bl}	4 -
Effectivity of total	C_{red}	75% -

Design value concrete strength

Material factor	γ_c	1,5
Add. mat. factor	γ_m	1,33 -
$f_{cd} =$		15,0 N/mm ²

"Splitting" of pile

Spread of forces		45 °
Length force flow		1206 mm
Splitting force		632 kN/m
Yield strength wall	$f_{yd} =$	355 N/mm ²
Capacity tubular pile		7100 kN/m
U.C.		0,09 < 1,00 OK

Steel tower stub

Yield strength	$f_{yd} =$	355 N/mm ²
Tensile strength	$f_{ud} =$	490 N/mm ²

Project: RLL-TBG
Mast: S+3/c & S+6/c

Welds of shear blocks of main leg

Out-of-plane loading

Plate

t = 50 mm
Grade S355
f_{yd} = 355 N/mm²
f_u = 490 N/mm²

Member forces

Factor 1,2
F_{t,Ed} = 0 kN
F_{v,Ed} = F_{Rd,c} / n = 173 kN
F_{v//,Ed} = 0 kN
M_{Ed} = 1/2 b / h x F_{v,Ed} = 2,60 kNm

Check

σ_{w,Ed} = 190 N/mm² ≤
σ₁ = 95 N/mm² ≤

Welds

a = 5 mm
l = 200 mm
β_w = 0,9 -
γ_{M2} = 1,25 -

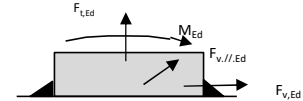

Stress components

σ₁ = τ₁ = F_{t,Ed} √2 / 4al = 0 N/mm²
σ₁ = τ₁ = F_{v,Ed} √2 / 4al = 61 N/mm²

61 N/mm²
b* = b + 2/3av₂ = 54,7 mm
σ₁ = τ₁ = 0,706M_{Ed} / al b* = 34 N/mm²
τ_{//} = F_{v//,Ed} / 2al = 0 N/mm²
σ_{w,Ed} = √(σ₁² + 3τ₁² + 3τ_{//}²) = 190 N/mm²

f_u / β_w γ_{M2} = 436 N/mm² U.C. = **0,44 OK**
0,9f_u / γ_{M2} = 353 N/mm² U.C. = **0,27 OK**

Welds of shear blocks of pile

Out-of-plane loading

Plate

t = 50 mm
Grade S355
f_{yd} = 355 N/mm²
f_u = 490 N/mm²

Member forces

Factor 1,2
F_{t,Ed} = 1/2 b / h x F_{v,Ed} = 95 kN
F_{v,Ed} = 317 kN
F_{v//,Ed} = 0 kN
M_{Ed} = 0,00 kNm

Check

σ_{w,Ed} = 233 N/mm² ≤
σ₁ = 116 N/mm² ≤

Welds

a = 5 mm
l = 250 mm
β_w = 0,9 -
γ_{M2} = 1,25 -

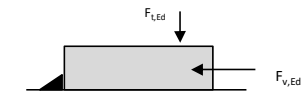

Stress components

σ₁ = τ₁ = F_{t,Ed} √2 / 2al = 27 N/mm²
σ₁ = τ₁ = F_{v,Ed} √2 / 2al = 90 N/mm²

116 N/mm²
τ_{//} = F_{v//,Ed} / 2al = 0 N/mm²
σ_{w,Ed} = √(σ₁² + 3τ₁² + 3τ_{//}²) = 233 N/mm²

f_u / β_w γ_{M2} = 436 N/mm² U.C. = **0,53 OK**
0,9f_u / γ_{M2} = 353 N/mm² U.C. = **0,33 OK**

Welds of foot plate

f_u / β_w γ_{M2} = 436 N/mm²
Weld size a = 5 mm
Length l = 2b + 2b - t = 764 mm
Capacity F_{Rd} = a x l x f_{w,d} / √3 = 961 kN

Principe blokdeuvels - S+9/c & S+12/c

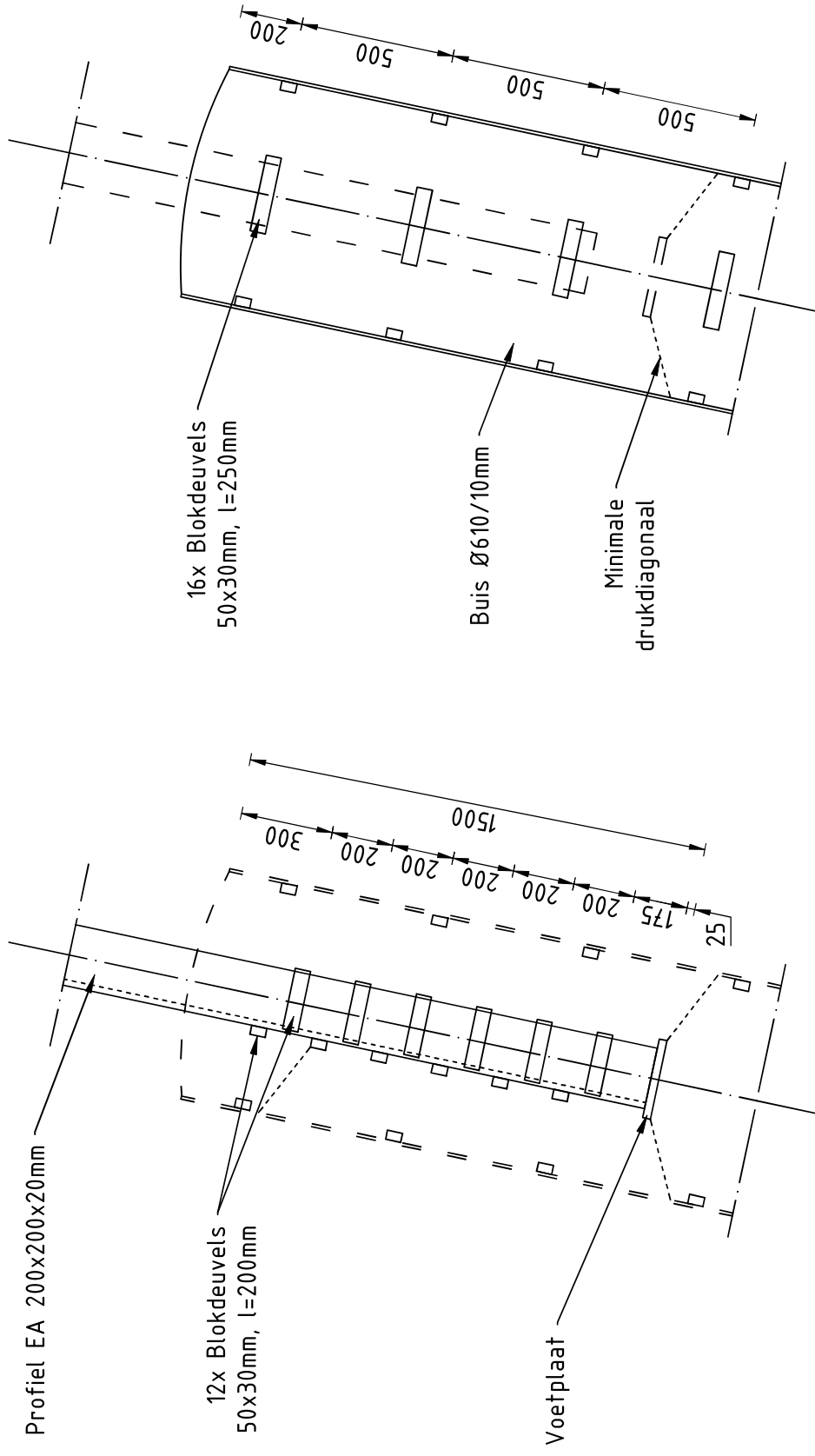

Algemene opmerkingen

- Aarding niet aangegeven
- Spiraalwapening niet aangegeven

Project: RLL-TBG
Mast: S+9/c & S+12/c

Shear blocks

NEN-EN 1993-1-1 en NEN-EN 1994-1-1

Datum: 2021-07-27

Auteur: TBR

Versie: 1.5

Load			Results		
Compression	$F_{Ed,c}$	2046 kN	Compression	U.C.	0,87 < 1,00 OK
Tension	$F_{Ed,t}$	1540 kN	Tension	U.C.	0,71 < 1,00 OK

Main leg

Profile		L200x20
Type		Single
Steel material		S355
Cross section		7635 mm ²
Axial capacity	N_{pl}	2710 kN
Width	b	200 mm
Thickness	t	20 mm
Length in concrete		1500 mm

Capacity shear blocks main leg

$A_{f1} = A_{f1,out} + A_{f1,in} =$	6000 mm ²
$A_{f2} = A_{f2,out} + A_{f2,in} =$	15400 mm ²
Slope	1 : 5
$C_A = \sqrt{A_{f2}/A_{f1}} =$	1,60
$f_{jd} = C_A \times f_{cd} =$	24,1 N/mm ²
$F_{Rd,c} = n_c \times A_{f1} \times f_{jd} =$	1445 kN
$F_{Rd,t} = n_t \times A_{f1} \times f_{jd} =$	1445 kN

Shear blocks main leg

Sides		1 (outside)
Width	b	50 mm
Thickness	h	30 mm
Length - outside	L_{out}	200 mm
Length - inside	L_{in}	mm
Eccentricity	e	-10 mm
Welds	a	5 mm
c.t.c. separation	s	200 mm
Number for compr.	n_c	10 -
Number for tension	n_t	10 -

Capacity foot plate

$K_d =$	1,73 -
$f_{jd} = C_A \times f_{cd} =$	26,0 N/mm ²
$c = t\sqrt{f_{yd} / 3f_{jd}} =$	53 mm
$m^* = \min(c, m) =$	30 mm
Type foot plate	Extending
Effective for	Compr. and tension
$A_{p,c} =$	35235 mm ²
$F_{Rd,c} = A_{p,druk} \times f_{jd} =$	918 kN
$A_{p,t} =$	27600 mm ²
$F_{Rd,t} = A_{p,t} \times f_{jd} =$	719 kN

Foot plate

Thickness	t	25 mm
Ext. length	m	30 mm
Welds	a	5 mm

Capacities

$F_{Rd,c,plate} =$	918 kN
$F_{Rd,blocks,c} =$	1445 kN
$F_{Rd,c} = F_{Rd,block} + F_{Rd,footplate} =$	2363 kN
U.C. compression	0,87 < 1,00 OK
Welds foot plate (see next page)	956 kN
$F_{Rd,t} = \min. (\text{welds} / \text{foot plate}) =$	719 kN
$F_{Rd,blocks,t} =$	1445 kN
$F_{Rd,t} = F_{Rd,block} + F_{Rd,footplate} =$	2164 kN
U.C. tension	0,71 < 1,00 OK
U.C. welds	0,44 < 1,00 OK

Pile

Name		Buispaal
Diameter		609 mm
Thickness		10 mm
Cross section		18818 mm ²
Steel material		S355
Capacity		6680 kN
Concrete strength		C30/37

Capacity shear blocks pile

$A_{f1} =$	7500 mm ²
$A_{f2} =$	41087 mm ²
$C_A = \sqrt{A_{f2}/A_{f1}} =$	2,34 -
$f_{jd} = K_d \times f_{cd} =$	35,2 N/mm ²
$F_{Rd,c} = n_c \times A_{f1} \times f_{jd} \times C_{red} =$	2376 kN
U.C. compression	0,86 < 1,00 OK
$F_{Rd,t} = n_t \times A_{f1} \times f_{jd} \times C_{red} =$	2376 kN
U.C. tension	0,65 < 1,00 OK
U.C. welds	0,53 < 1,00 OK

Shear blocks pile

Width	b	50 mm
Thickness	h	30 mm
Length	L	250 mm
Welds	a	5 mm
c.t.c. separation	s	500 mm
Number for compr.	n_c	12 -
Number for tension	n_t	12 -
Blocks per row	n_{bl}	4 -
Effectivity of total	C_{red}	75% -

Design value concrete strength

Material factor	γ_c	1,5
Add. mat. factor	γ_m	1,33 -
$f_{cd} =$		15,0 N/mm ²

"Splitting" of pile

Spread of forces		45 °
Length force flow		1206 mm
Splitting force		639 kN/m
Yield strength wall	$f_{yd} =$	355 N/mm ²
Capacity tubular pile		7100 kN/m
U.C.		0,09 < 1,00 OK

Steel tower stub

Yield strength	$f_{yd} =$	355 N/mm ²
Tensile strength	$f_{ud} =$	490 N/mm ²

Project: RLL-TBG
Mast: S+9/c & S+12/c

Welds of shear blocks of main leg

Out-of-plane loading

Plate

t = 50 mm
Grade S355
f_{yd} = 355 N/mm²
f_u = 490 N/mm²

Member forces

Factor 1,2
F_{t,Ed} = 0 kN
F_{v,Ed} = F_{rd,c} / n = 173 kN
F_{v//,Ed} = 0 kN
M_{Ed} = 1/2 b / h x F_{v,Ed} = 2,60 kNm

Check

σ_{w,Ed} = 190 N/mm² ≤
σ₁ = 95 N/mm² ≤

Welds

a = 5 mm
l = 200 mm
β_w = 0,9 -
γ_{M2} = 1,25 -

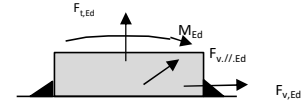

Stress components

σ₁ = τ₁ = F_{t,Ed} √2 / 4al = 0 N/mm²
σ₁ = τ₁ = F_{v,Ed} √2 / 4al = 61 N/mm²
σ₁ = τ₁ = F_{v,Ed} √2 / 4al = 61 N/mm²
b* = b + 2/3av₂ = 54,7 mm
σ₁ = τ₁ = 0,706M_{Ed} / al b* = 34 N/mm²
τ_{//} = F_{v//,Ed} / 2al = 0 N/mm²
σ_{w,Ed} = √(σ₁² + 3τ₁² + 3τ_{//}²) = 190 N/mm²

f_u / β_w γ_{M2} = 436 N/mm² U.C. = 0,44 OK
0,9f_u / γ_{M2} = 353 N/mm² U.C. = 0,27 OK

Welds of shear blocks of pile

Out-of-plane loading

Plate

t = 50 mm
Grade S355
f_{yd} = 355 N/mm²
f_u = 490 N/mm²

Member forces

Factor 1,2
F_{t,Ed} = 1/2 b / h x F_{v,Ed} = 95 kN
F_{v,Ed} = 317 kN
F_{v//,Ed} = 0 kN
M_{Ed} = 0,00 kNm

Check

σ_{w,Ed} = 233 N/mm² ≤
σ₁ = 116 N/mm² ≤

Welds

a = 5 mm
l = 250 mm
β_w = 0,9 -
γ_{M2} = 1,25 -

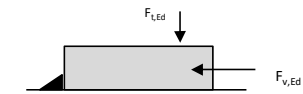

Stress components

σ₁ = τ₁ = F_{t,Ed} √2 / 2al = 27 N/mm²
σ₁ = τ₁ = F_{v,Ed} √2 / 2al = 90 N/mm²
σ₁ = τ₁ = F_{v,Ed} √2 / 2al = 90 N/mm²
τ_{//} = F_{v//,Ed} / 2al = 0 N/mm²
σ_{w,Ed} = √(σ₁² + 3τ₁² + 3τ_{//}²) = 233 N/mm²

f_u / β_w γ_{M2} = 436 N/mm² U.C. = 0,53 OK
0,9f_u / γ_{M2} = 353 N/mm² U.C. = 0,33 OK

Welds of foot plate

f_u / β_w γ_{M2} = 436 N/mm²
Weld size a = 5 mm
Length l = 2b + 2b - t = 760 mm
Capacity F_{Rd} = a x l x f_{w,d} / √3 = 956 kN



APPENDIX E

Liggers

CHECK OF BEAMS COMBI-SUSPENSION TOWERS

1 INTRODUCTION

The following report studies the members subjected to bending forces in the S+0 C (combi) tower. Figure 1 shows the outline of the tower. The members subjected to large bending and torsion forces are highlighted in yellow and blocked in red rectangles. These members are studied in detail via this report.

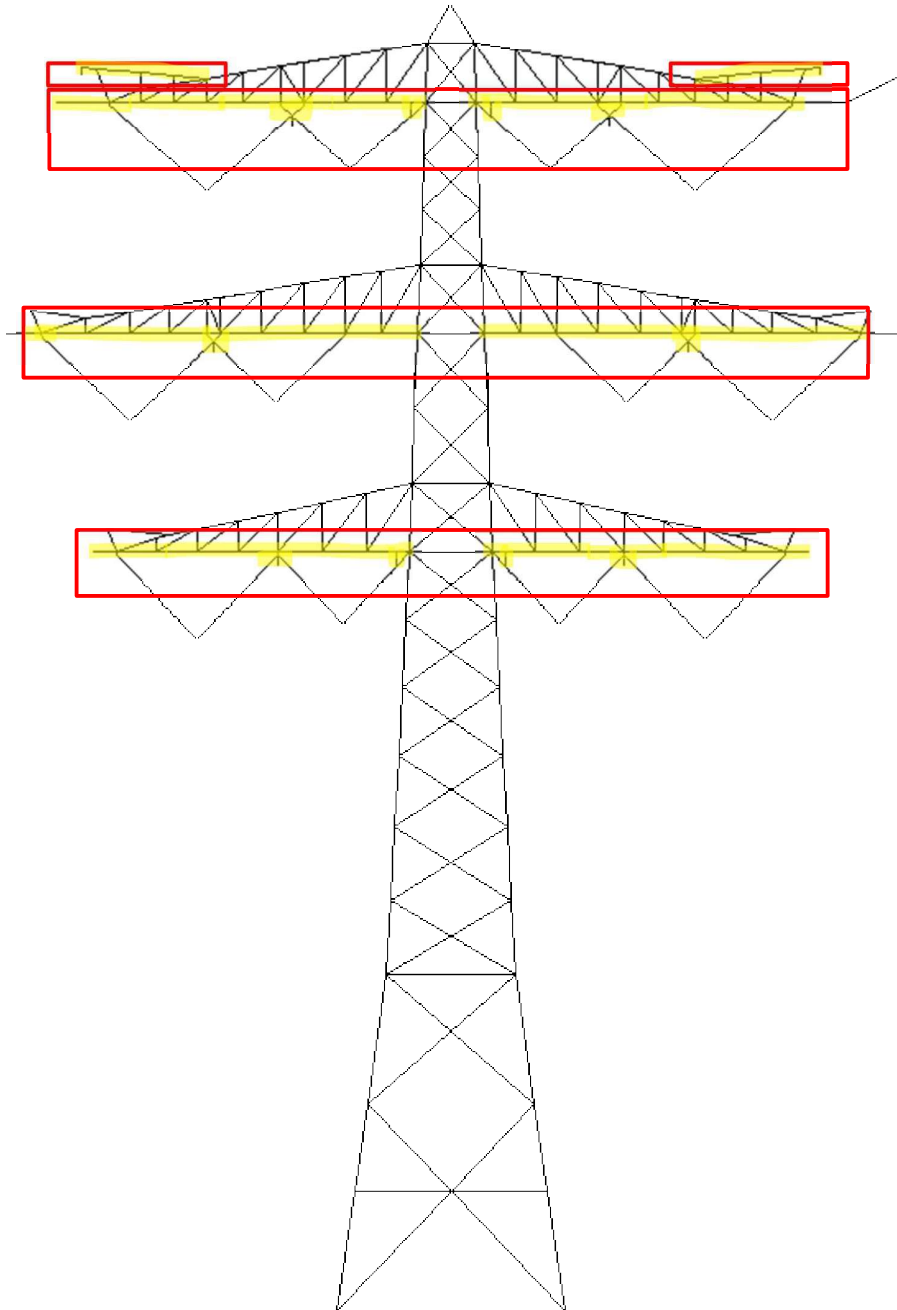

Figure 1 Front view of the S-c tower in PLS tower

The following are the aim of the current study:

1. To understand the structural efficacy of the H – Beams supporting the insulator assembly. The insulator assembly are attached the H beams eccentrically. Subsequently, the H – beams develop bi-axial bending and torsion. PLS tower, the application primarily used for the analysis of the towers is inept at checking structures for bending as well as torsion. Thus, the structures nesting the insulator assemblies are modelled and checked in AxisVM application.
2. The bottom chord of the cross arm develops bending moments due to the loading from the insulators. The moments are large enough, that they cannot be neglected and thus required to be checked in AxisVM.

1.1 Modelling and Geometry:

The geometry from PLS tower is exported and further developed in AxisVM. Figure 2 shows the cross – arms (referred as lower cross arm – LCA, Mid cross arm – MCA and Upper cross arm – UCA, here forth in this report) of the tower as modelled in AxisVM. The details of the profiles used is also visible. The nomenclature for the attachment points is given in Figure 2. The details of the beams nesting the insulator assembly is given in Figure 3.

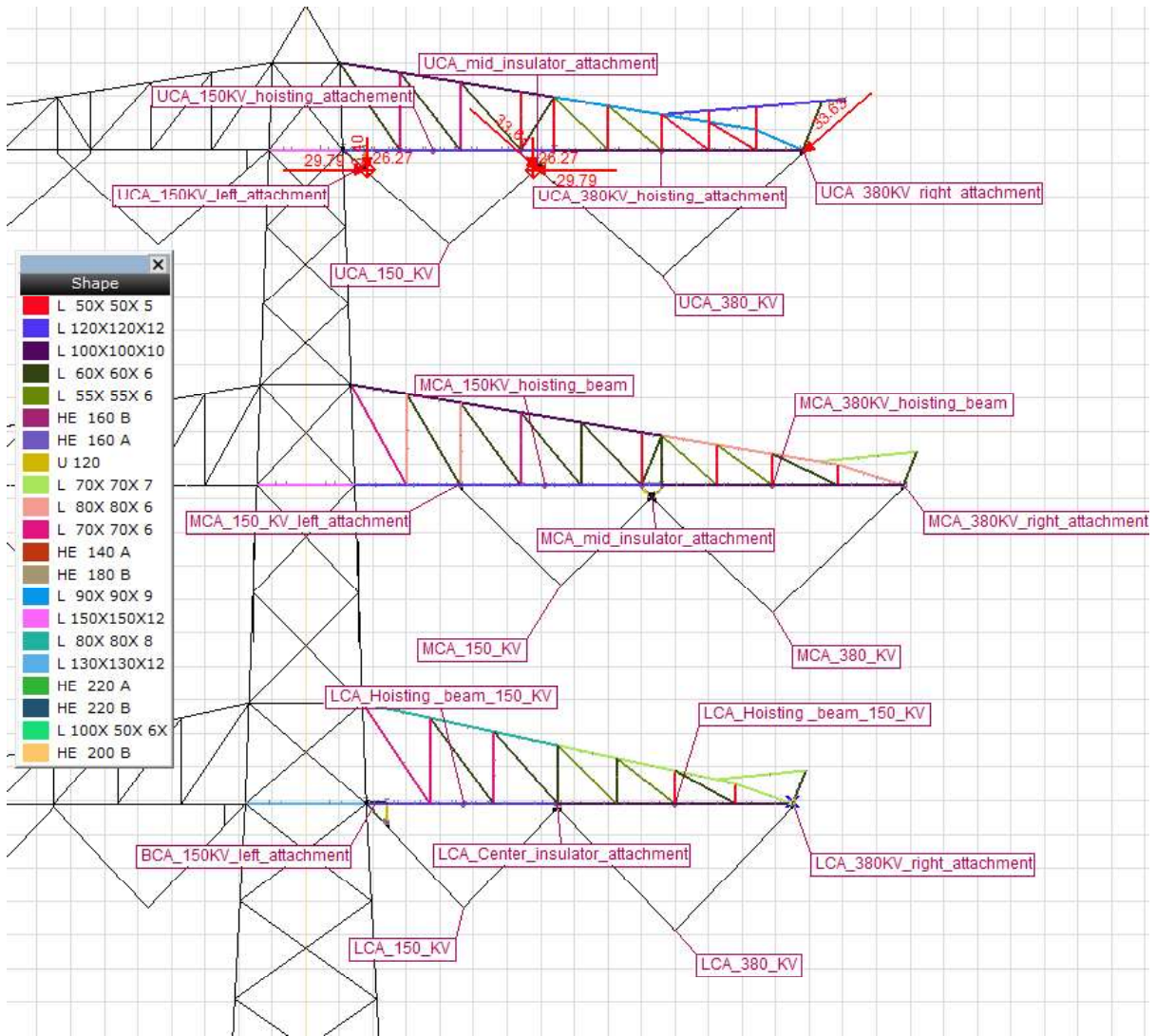
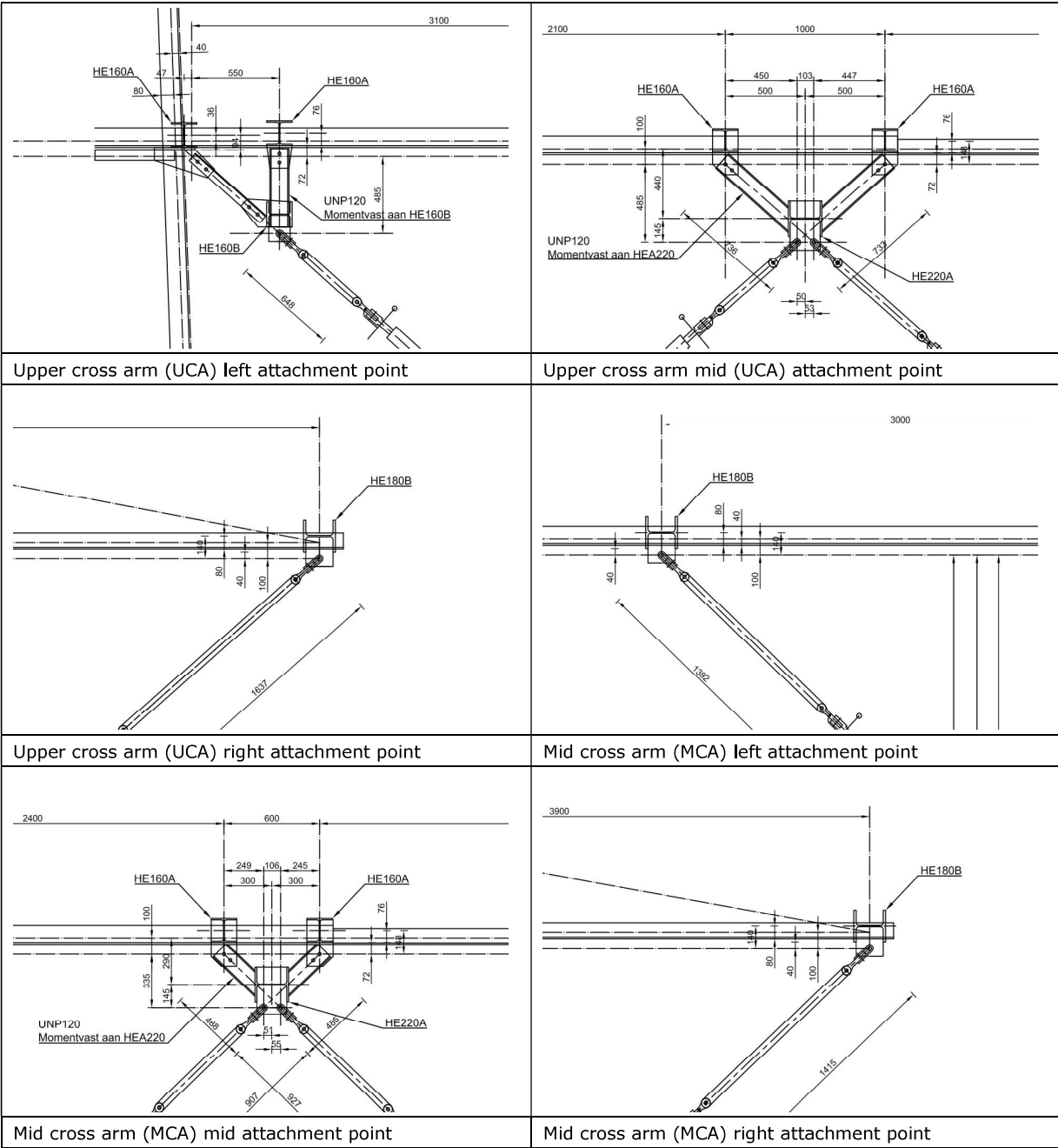

Figure 2 Geometry of cross arms in AxisVM.

The details of the beam systems nesting the insulator assembly in the tower are shown in Figure 3. The size along with the location of the H beams are marked in the figure. The dimension marking the eccentricity in the system have been modelled in AxisVM to capture the torsion in the system.



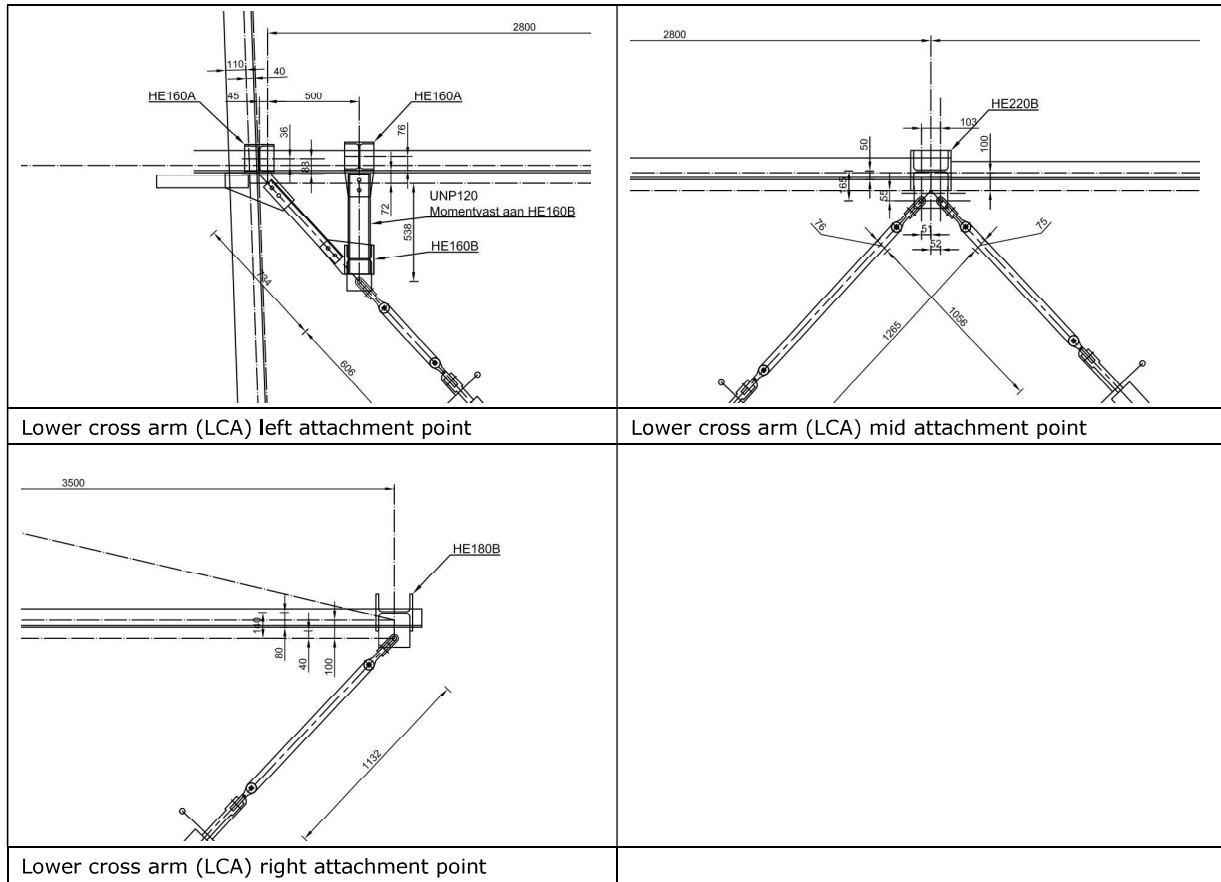

Figure 3 details of beam supporting the insulators

1.2 Loading

The loading is taken from the PLS tower. The following load cases are replicated in AxisVM. The details of the loads applied in PLS tower can be looked in the main report supplemented by "Geleiderbealsting calculation". Table 1 shows the details of the loads applied in AxisVM. The relevant loads are highlighted in yellow. The location of the load application is given along with Load case ID in the column - "Particulars". For load cases 1a_90 to 3_90, the loads are applied as point loads applied in the direction of the insulators. The value of the loads corresponds to the member forces in the insulators of the PLS tower output. The load cases 5a, 144 and 145 correspond to conductor and isolator failure. A load case for the loads coming on the tower during the hoisting of the isolators has been simulated.

Table 1 Loading applied in AxisVM for various load cases

	Particulars
	<p>ULS_1a_90 - LCA</p>

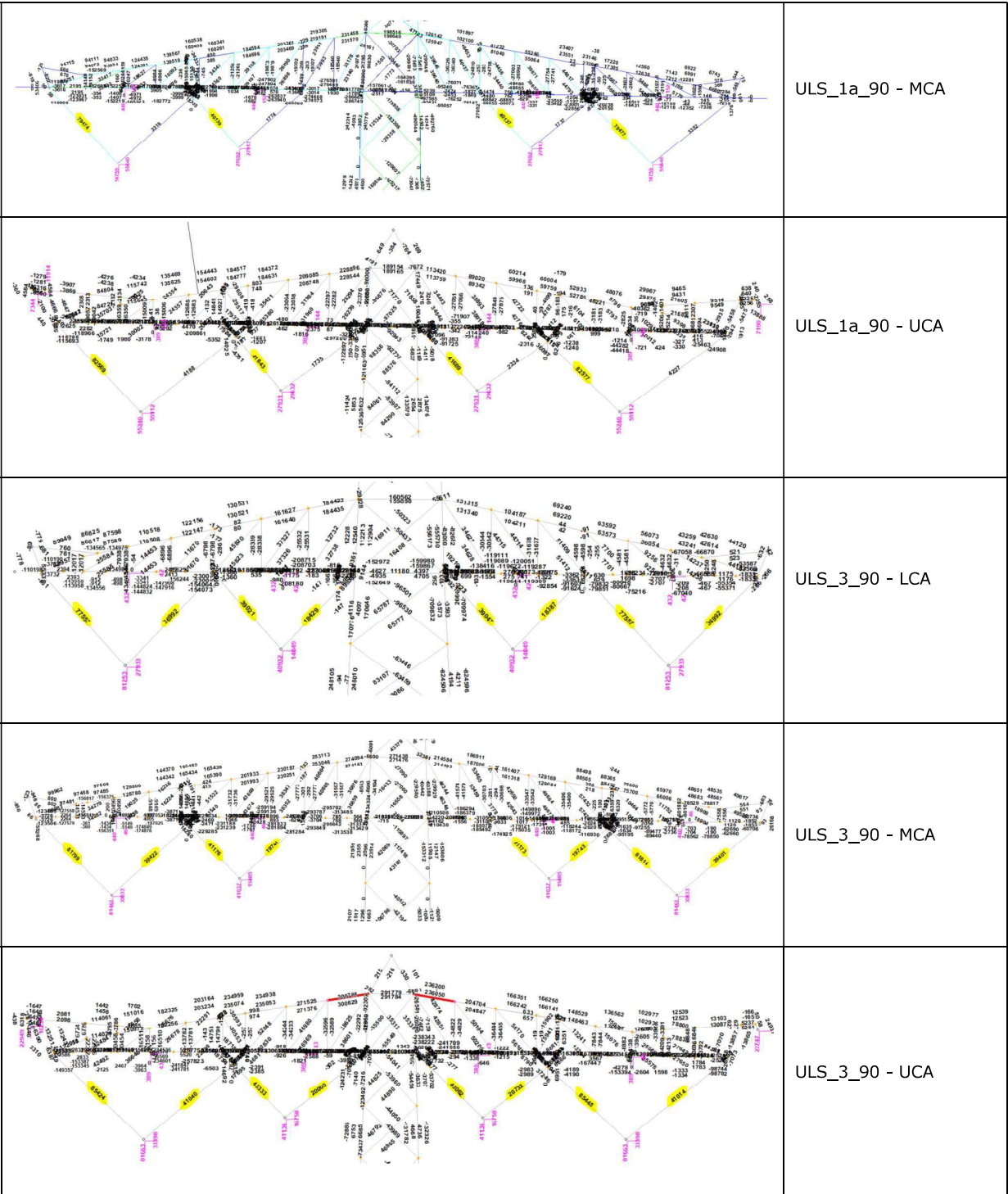

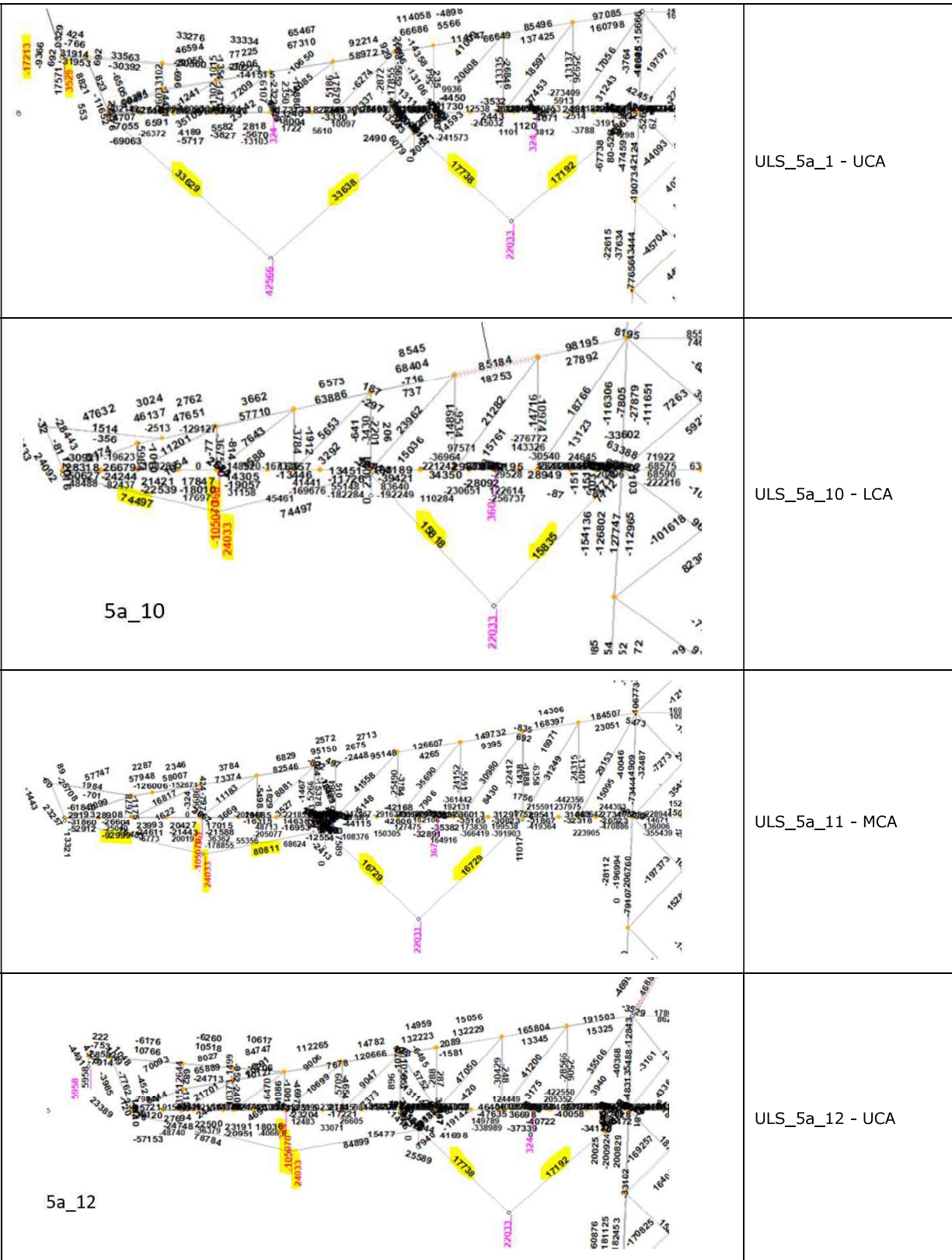

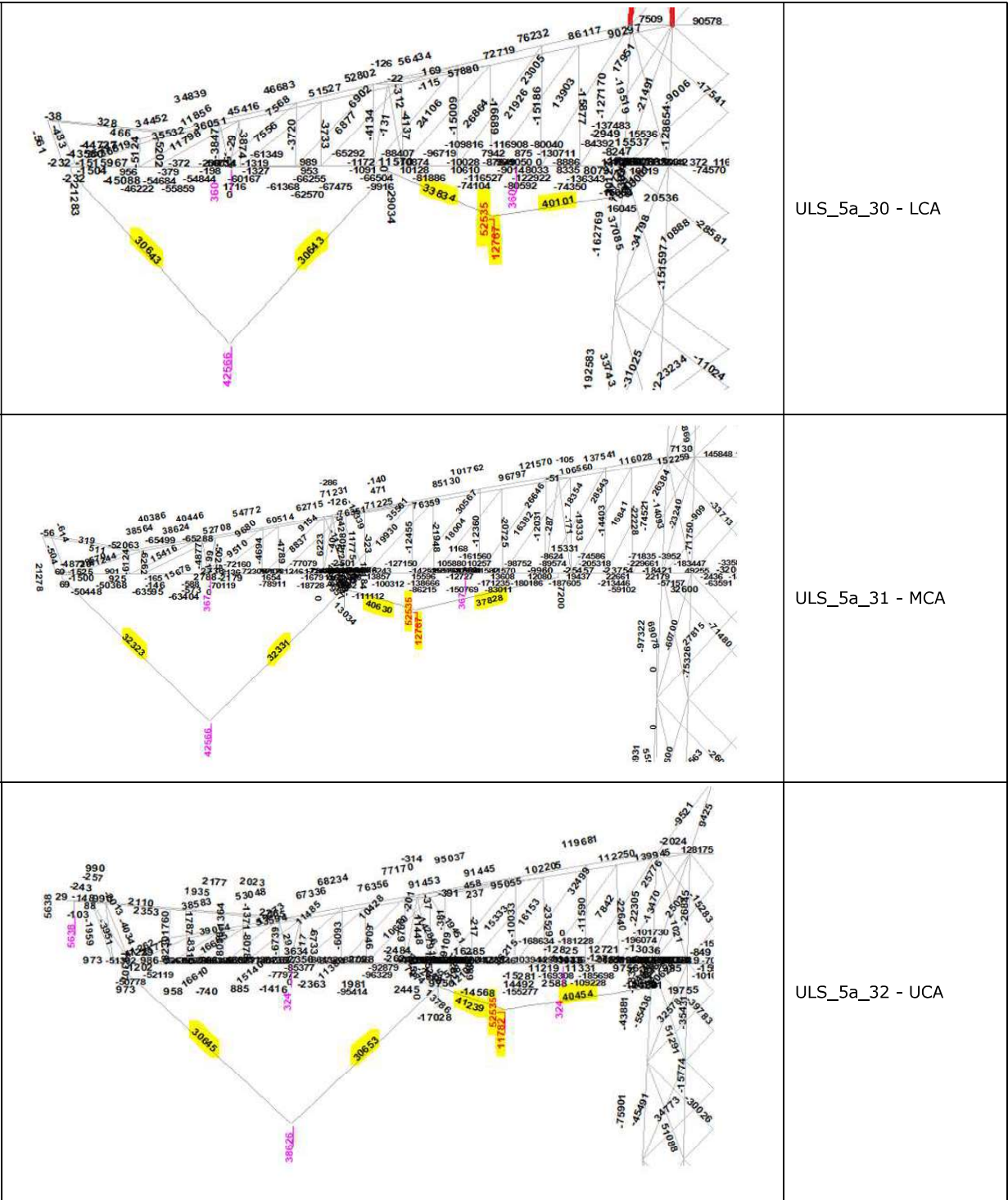

Uls_5a_30 - LCA

Uls_5a_31 - MCA

Uls_5a_32 - UCA

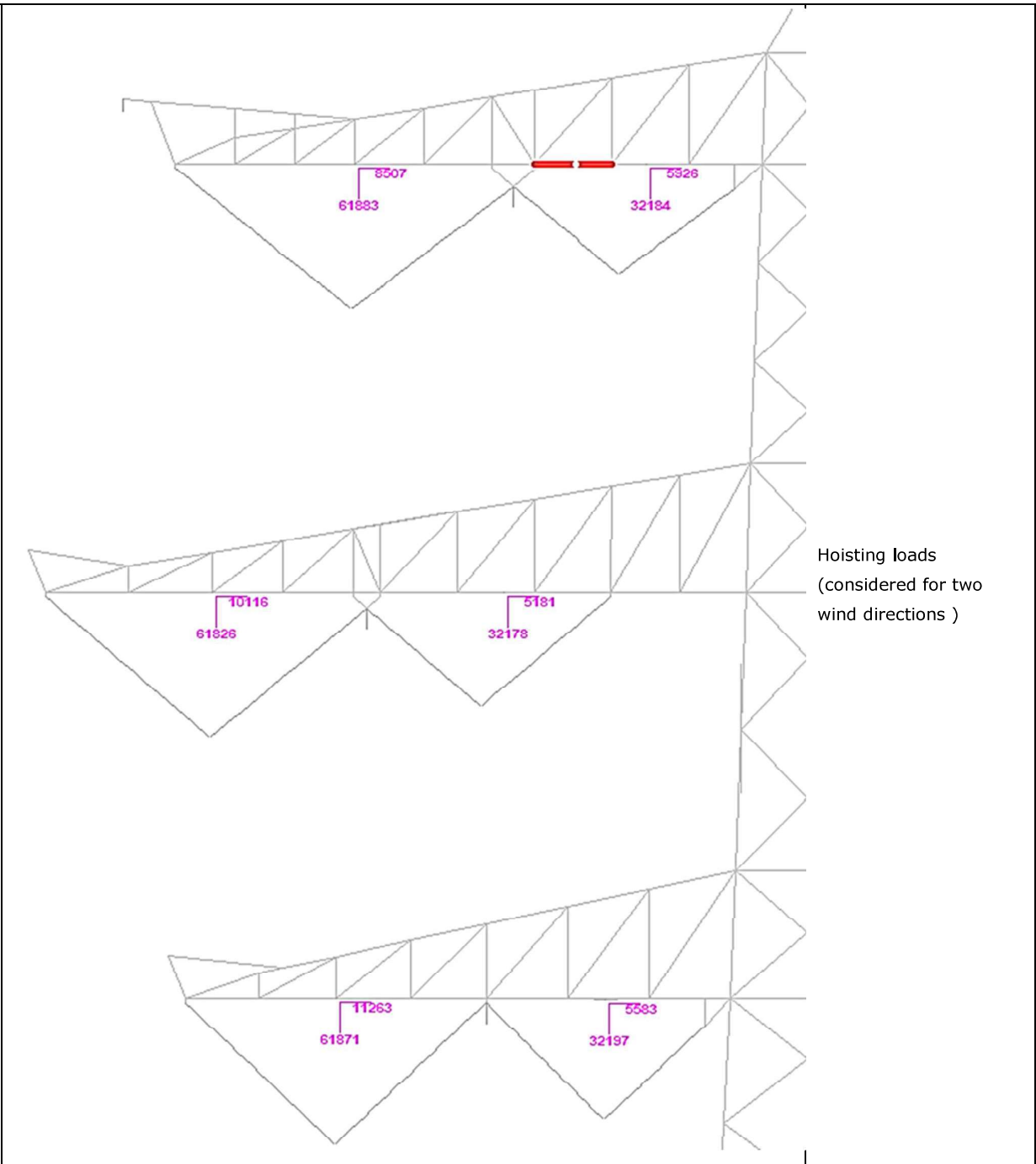

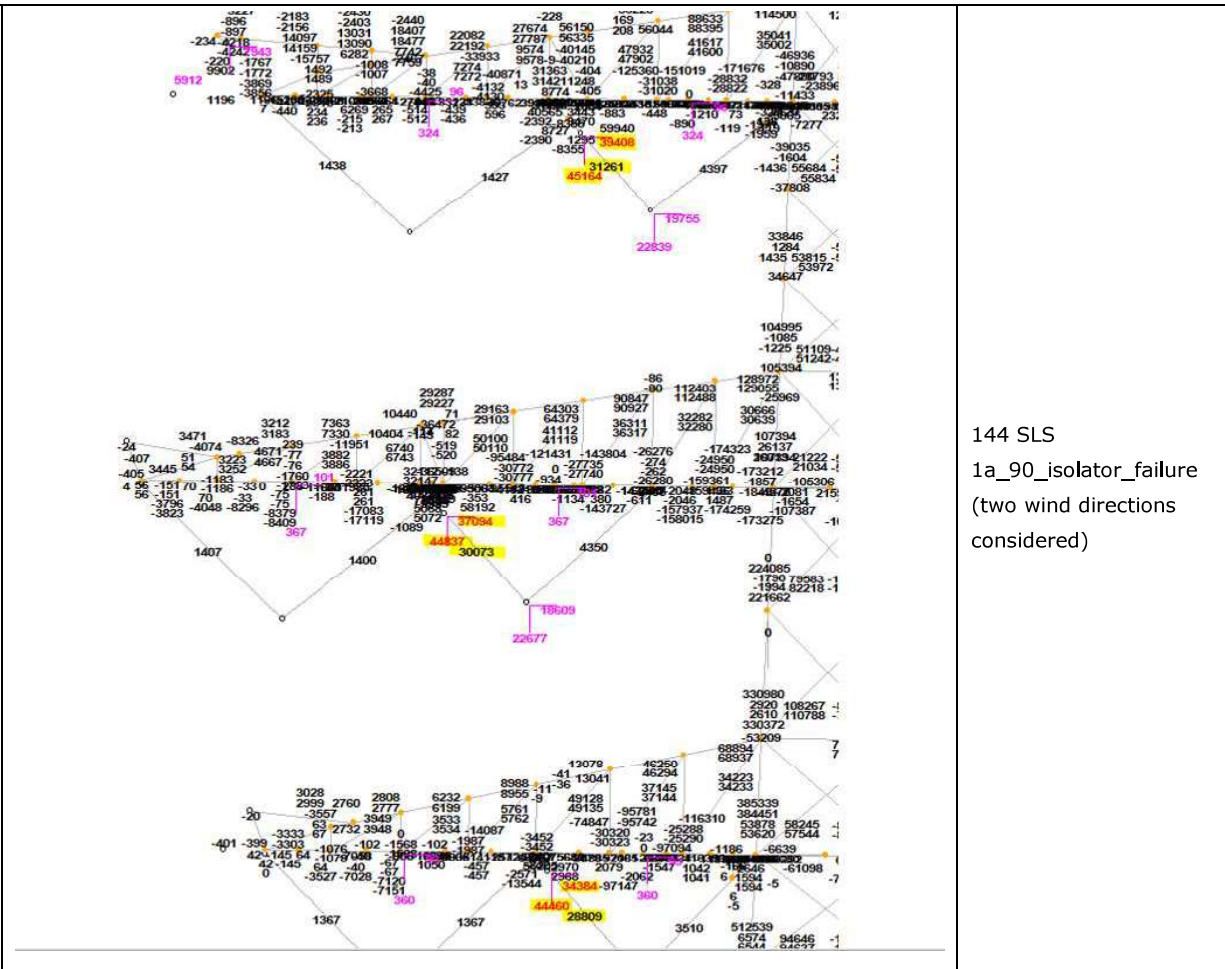

144 SLS
 1a_90_isolator_failure
 (two wind directions considered)

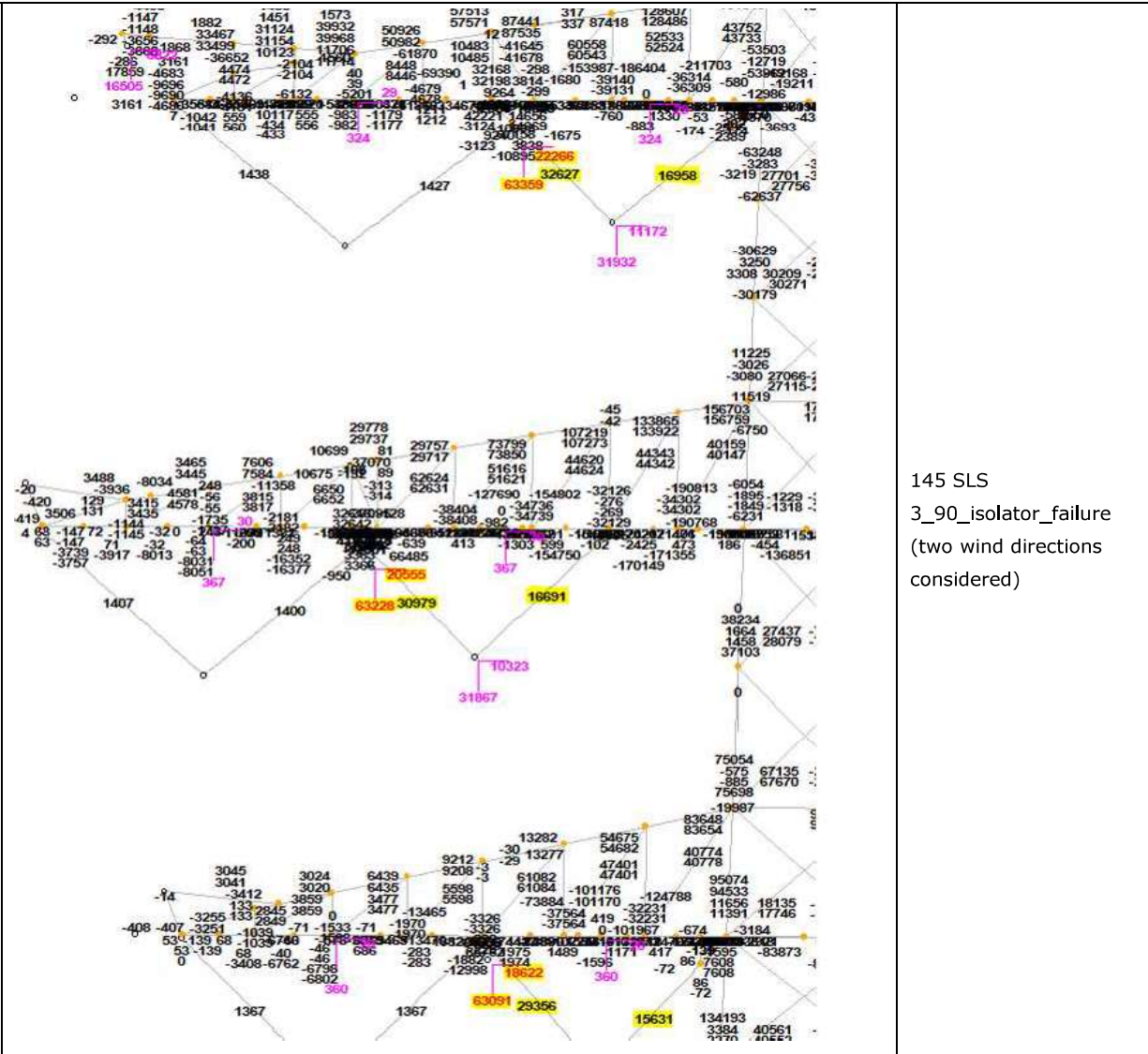

The failure of conductor on one side results in unbalanced forces on the insulator. The insulator swings out of the plane about the out of plane hinge, as marked in figure 4. The green arrows show the direction of insulator during load case 5a and the direction for rest of the load cases is marked in blue arrow. The part of load of insulator between the two hinges remains aligned the normal direction even during the conductor failure. This part has been shown in green dashed lines. The point of application of load during load case 5a thus changes from the in-plane hinge to the out of plane hinge

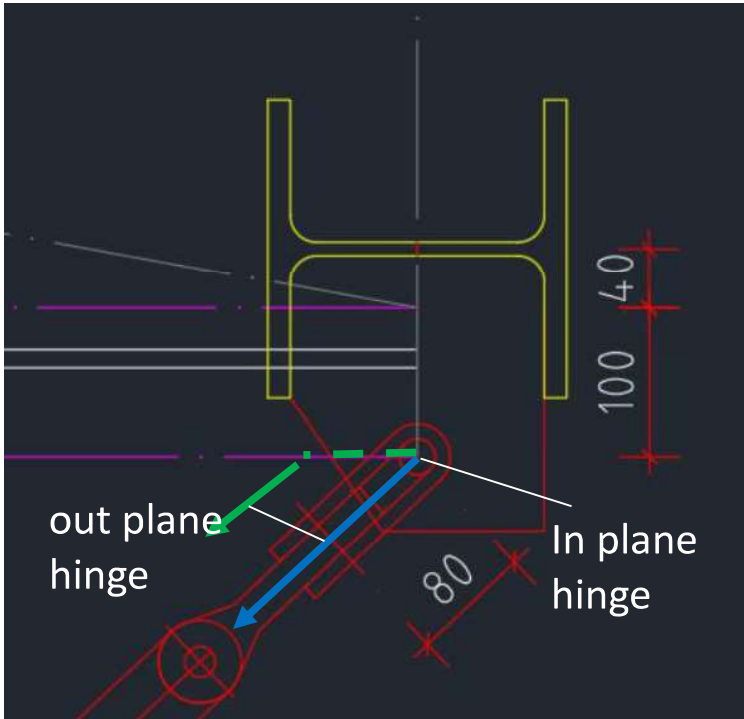

Figure 4 Out of plane hinge in the insulator.

Figure 5 shows the load application points for the right insulator attachment of the MCA in AxisVM model. The figure on right shows the load application for load case 3_90 (generic load case) at the in-plane hinge. The figure on right shows the load application for 5a_11 load case. The point of application has shifted the out of plane hinge. The out of plane hinge has swung to a horizontal position.



Figure 5 Load application points for load case 5a

The insulator is no longer in the vertical plane, when the conductor fails. Thus, the forces can no longer be applied along the determinate directions of insulators. The positions of the insulator are not determined. Forces to be applied at the vertical hinge is determined by evaluating the X and Y component of the force seen in the insulator in the PLS tower post processing. Table 2 and Table 3 gives the X & Y component for the load cases 5a as explained above.

Table 2 Horizontal loads for the 5a_10, 5a_11 & 5a_12

		5a_10 (LCA)	5a_11 (MCA)	5a_12 (UCA)
transverse	X	52.54	52.54	52.54
longitudinal	Y	49.85	55.55	60.01
Load from conductor		105.07	105.07	105.07
angle with vertical		43.50	46.60	48.80

Table 3 Horizontal loads for the 5a_30, 5a_31 & 5a_32

		5a_30 (LCA)	5a_31 (MCA)	5a_32 (UCA)
transverse	X	26.27	26.27	26.27
longitudinal	Y	24.41	27.49	29.79
Load from conductor		52.54	52.54	52.54
angle with vertical		42.90	46.30	48.60

The vertical force gets equally distributed at both the attachment point of the conductor.

1.3 Results

The internal forces in the beam assembly supporting the insulators is taken from AxisVM and checked via excel calculation for bending and torsion. The resulting stresses are compared against the yield limit. The detailed results from AxisVM can be found in the appendix – AxisVM report. The AxisVM package does not calculate the warping moment M_{wEd} . Hence, the beams with torsion is checked via excel calculation. Figure 5 to 8 gives the calculation for the H-beams in the LCA, MCA and UCA in the tower.

The stress in the beams due to combination of the internal forces is found to be within the yield limit.

Axis VM ID		10,11,12	70,71	13,14,15	541	1,2	546	3,4	
Beam Location		left_top_l	left_top_r	left_bot	hoisting beam	mid	hoisting beam	right	
Profile of beam		HEA 160	HEA 160	HEB 160	HEA 140	HEB220	HEA 140	HEA 220	
$M_{w,Ed} =$									
$M_{y,Ed} =$		4.5	16.6	7.2	24.5	35.4	26.6	14.6	kNm
$M_{z,Ed} =$		3.8	0.4	7.3	0.5	35.4	4.8	14.2	kNm
Torsion =		1	0	2.1	0.3	5.4	0.6	7	kNm
Orientation of beam		y-as	y-as	z-as	y-as	z-as	y-as	z-as	
Torsional moment	T	1.00	0.00	2.10	0.30	5.40	0.60	7.00	kNm
Beams									
Beam length	L	3600	987	3748	3000	2430	1716	1000	mm
Yield stress	f_y	355	355	355	355	355	355	355	Mpa
Elastic modulus	E	210000	210000	210000	210000	210000	210000	210000	Mpa
Shear modulus	G	81000	81000	81000	81000	81000	81000	81000	Mpa
Profile		HEA 140	HEA 160	HEB 160	HEA 140	HEB 220	HEA 140	HEA 220	
		HEA140	HEA160	HEB160	HEA140	HEB220	HEA140	HEA220	
Height	h	133	152	160	133	220	133	210	mm
Width	b	140	160	160	140	220	140	220	mm
Web thickness	t_w	5.5	6.0	8.0	5.5	9.5	5.5	7.0	mm
Flange thickness	t_f	8.5	9.0	13.0	8.5	16.0	8.5	11.0	mm
Torsional constant	I_t	8	12	31	8	77	8	28	mm ⁴
Warping constant	I_{wa}	15064	31410	47943	15064	295418	15064	193266	mm ⁶
Moment of inertia	I_y	1033	1673	2492	1033	8091	1033	5410	mm ⁴
	I_z	389	616	889	389	2843	389	1955	mm ⁴
Flange stiffness	$I_f = I_z / 2 =$	195	308	445	195	1422	195	977	mm ³
Moment of resistance	$W_{y,el}$	155	220	311	155	736	155	515	mm ³
	$W_{z,el}$	56	77	111	56	258	56	178	mm ³
Torsional bending constant	d	697	829	630	697	997	697	1335	mm
	L/d	5.2	1.2	5.9	4.3	2.4	2.5	0.7	
	α	0.5	0.5	0.5	0.5	0.5	0.5	0.5	
Acting moments:									
$M_{w,Ed} = E \cdot I_r \cdot (h-t_f) \cdot \phi'' / 2 =$		2.8	0.0	4.5	0.8	11.1	1.4	8.4	kNm
$M_{y,Ed} = 1/4 \cdot F \cdot L =$		4.5	16.6	7.2	24.5	35.4	26.6	14.6	kNm
$M_{z,Ed} = 1/4 \cdot F \cdot L =$		3.8	0.4	7.3	0.5	35.4	4.8	14.2	kNm
Capacities of beams:									
$M_{w,Rd} = W_{z,el} \cdot f_y / 2 =$		9.9	13.7	19.7	9.9	45.9	9.9	31.5	kNm
$M_{y,Rd} = W_{y,el} \cdot f_y =$		55.2	78.1	110.6	55.2	261.1	55.2	182.9	kNm
$M_{z,Rd} = W_{z,el} \cdot f_y =$		19.7	27.3	39.5	19.7	91.8	19.7	63.1	kNm
Combined check of beam:									
UC		0.55	0.23	0.48	0.55	0.76	0.87	0.57	
Displacements:									
Factor F_{ed} / F_k		1.2	1.2	1.2	1.2	1.2	1.2	1.2	
Displacement y-direction	u_y	1.58	0.01	1.36	0.14	0.85	0.45	0.09	mm
Relative displacement	rel.	2284	128143	2754	20828	2844	3793	11520	-
Displacement z-direction	u_z	4.95	0.87	3.76	18.73	2.43	6.65	0.25	mm
Relative displacement	rel.	727	1136	996	160	1000	258	4048	-

Axis VM ID		5,545	542	.6,17,18,1!	49,50	0,21,22,54	547	6,7	
Beam Location		left	hoisting beam	mid_top_l	mid_bot	mid_top_r	hoisting beam	right	
Profile of beam		HEB 180	HEA 140	HEB 160	HEA 220	HEB 160	HEA 140	HEA 180	
From AxisVM Analysis									
$M_{w,Ed} =$									
$M_{y,Ed} =$		15.2	18.3	14.2	14.7	15.8	22.6	16	kNm
$M_{z,Ed} =$		17.8	0.7	6.3	21.2	6.9	3.7	14.1	kNm
Torsion =		2.1	0.3	1.2	4.9	1.3	0.5	5.5	kNm
Orientation of beam		z-as	y-as	y-as	z-as	y-as	y-as	z-as	
Beams									
Beam length	L	2548	2252	1910	1000	1840	1458	1000	mm
Yield stress	f_y	355	355	355	355	355	355	355	Mpa
Elastic modulus	E	210000	210000	210000	210000	210000	210000	210000	Mpa
Shear modulus	G	81000	81000	81000	81000	81000	81000	81000	Mpa
Profile		HEB 180	HEA 140	HEB 160	HEA 220	HEB 160	HEA 140	HEA 180	
		HEB180	HEA140	HEB160	HEA220	HEB160	HEA140	HEA180	
Height	h	180	133	160	210	160	133	171	mm
Width	b	180	140	160	220	160	140	180	mm
Web thickness	t_w	8.5	5.5	8.0	7.0	8.0	5.5	6.0	mm
Flange thickness	t_f	14.0	8.5	13.0	11.0	13.0	8.5	9.5	mm
Torsional constant	I_t	42	8	31	28	31	8	15	mm ⁴
Warping constant	I_{wa}	93746	15064	47943	193266	47943	15064	60211	mm ⁶
Moment of inertia	I_y	3831	1033	2492	5410	2492	1033	2510	mm ⁴
	I_z	1363	389	889	1955	889	389	925	mm ⁴
Flange stiffness	$I_f = I_z / 2 =$	681	195	445	977	445	195	462	mm ³
Moment of resistance	$W_{y,el}$	426	155	311	515	311	155	294	mm ³
	$W_{z,el}$	151	56	111	178	111	56	103	mm ³
Torsional bending constant	d	759	697	630	1335	630	697	1032	mm
	L/d	3.4	3.2	3.0	0.7	2.9	2.1	1.0	
	a	0.5	0.5	0.5	0.5	0.5	0.5	0.5	
Acting moments:									
$M_{w,Ed} = E \cdot I_f \cdot (h-t_f) \cdot \phi'' / 2 =$		4.5	0.8	2.3	5.9	2.5	1.1	7.9	kNm
$M_{y,Ed} = 1/4 \cdot F \cdot L =$		15.2	18.3	14.2	14.7	15.8	22.6	16.0	kNm
$M_{z,Ed} = 1/4 \cdot F \cdot L =$		17.8	0.7	6.3	21.2	6.9	3.7	14.1	kNm
Capacities of beams:									
$M_{w,Rd} = W_{z,el} \cdot f_y / 2 =$		26.9	9.9	19.7	31.5	19.7	9.9	18.2	kNm
$M_{y,Rd} = W_{y,el} \cdot f_y =$		151.1	55.2	110.6	182.9	110.6	55.2	104.2	kNm
$M_{z,Rd} = W_{z,el} \cdot f_y =$		53.8	19.7	39.5	63.1	39.5	19.7	36.5	kNm
Combined check of beam:									
UC		0.60	0.45	0.41	0.60	0.44	0.71	0.97	
Displacements:									
Factor F_{ed} / F_k		1.2	1.2	1.2	1.2	1.2	1.2	1.2	
Displacement y-direction	u_y	1.00	0.11	0.30	0.13	0.31	0.25	0.19	mm
Relative displacement	rel.	2554	19818	6263	7716	5936	5791	5384	-
Displacement z-direction	u_z	2.39	7.88	1.93	0.25	1.99	4.08	0.57	mm
Relative displacement	rel.	1064	286	991	4021	925	357	1748	-

Steel beams in torsion										Datum: 2021/02/22
Calculation of unrestrained beams with eccentric load - Upper cross arm										Auteur: RSH
										Versie: 1.1
Axis VM ID		23,24,25	60,61	26,27,28	543	29,30,31	51,52	32,524,525	548	8,9
Beam Location		left_top_l	left_bot	left_top_r	hoisting	mid_top_l	mid_bot	mid_top_r	hoisting	right
Profile of beam		HEA 160	HEB 160	HEA 160	HEA 140	HEB 160	HEA 220	HEB 160	HEA 140	HEB180
From AxisVM Analysis										
$M_{w,Ed} =$										
$M_{y,Ed} =$		3.1	8.5	9.3	15.9	10.5	15.7	10.6	21	17.1 kNm
$M_{z,Ed} =$		4.5	7.2	0.6	0.5	4.9	21.3	5.8	2.9	14.2 kNm
Torsion =		0.9	1.9	0	0.3	2.3	5.2	2.7	0.5	4.7 kNm
Orientation of beam		y-as	z-as	y-as	y-as	y-as	z-as	y-as	y-as	z-as
Beams										
Beam length	L	2196	1000	2140	1960	1730	1000	1642	1366	1000 mm
Yield stress	f_y	355	355	355	355	355	355	355	355	355 Mpa
Elastic modulus	E	210000	210000	210000	210000	210000	210000	210000	210000	210000 Mpa
Shear modulus	G	81000	81000	81000	81000	81000	81000	81000	81000	81000 Mpa
Profile		HEA 160	HEA 160	HEB 160	HEA 140	HEB 160	HEA 220	HEB 160	HEA 140	HEA 180
Height	h	152	152	160	133	160	210	160	133	171 mm
Width	b	160	160	160	140	160	220	160	140	180 mm
Web thickness	t_w	6.0	6.0	8.0	5.5	8.0	7.0	8.0	5.5	6.0 mm
Flange thickness	t_f	9.0	9.0	13.0	8.5	13.0	11.0	13.0	8.5	9.5 mm
Torsional constant	I_t	12	12	31	8	31	28	31	8	15 mm ⁴
Warping constant	I_{wa}	31410	31410	47943	15064	47943	193266	47943	15064	60211 mm ⁶
Moment of inertia	I_y	1673	1673	2492	1033	2492	5410	2492	1033	2510 mm ⁴
	I_z	616	616	889	389	889	1955	889	389	925 mm ⁴
Flange stiffness	$I_f = I_z / 2 =$	308	308	445	195	445	977	445	195	462 mm ³
Moment of resistance	$W_{y,el}$	220	220	311	155	311	515	311	155	294 mm ³
	$W_{z,el}$	77	77	111	56	111	178	111	56	103 mm ³
Torsional bending constant	d	829	829	630	697	630	1335	630	697	1032 mm
	L/d	2.6	1.2	3.4	2.8	2.7	0.7	2.6	2.0	1.0
	α	0.5	0.5	0.5	0.5	0.5	0.5	0.5	0.5	0.5
Acting moments:										
$M_{w,Ed} = E \cdot I_f \cdot (h-t_f) \cdot \phi'' / 2 =$		2.3	3.0	0.0	0.7	4.3	6.3	5.0	1.1	6.8 kNm
$M_{y,Ed} = 1/4 \cdot F \cdot L =$		3.1	8.5	9.3	15.9	10.5	15.7	10.6	21.0	17.1 kNm
$M_{z,Ed} = 1/4 \cdot F \cdot L =$		4.5	7.2	0.6	0.5	4.9	21.3	5.8	2.9	14.2 kNm
Capacities of beams:										
$M_{w,Rd} = W_{z,el} \cdot f_y / 2 =$		13.7	13.7	19.7	9.9	19.7	31.5	19.7	9.9	18.2 kNm
$M_{y,Rd} = W_{y,el} \cdot f_y =$		78.1	78.1	110.6	55.2	110.6	182.9	110.6	55.2	104.2 kNm
$M_{z,Rd} = W_{z,el} \cdot f_y =$		27.3	27.3	39.5	19.7	39.5	63.1	39.5	19.7	36.5 kNm
Combined check of beam:										
UC		0.37	0.59	0.10	0.39	0.44	0.62	0.50	0.63	0.92
Displacements:										
Factor F_{Ed} / F_k		1.2	1.2	1.2	1.2	1.2	1.2	1.2	1.2	1.2
Displacement y-direction	u_y	0.43	0.14	0.04	0.06	0.19	0.13	0.21	0.17	0.19 mm
Relative displacement	rel.	5119	7026	58690	31879	8890	7680	7913	7887	5346 -
Displacement z-direction	u_z	0.80	0.46	1.58	5.19	1.17	0.27	1.06	3.33	0.61 mm
Relative displacement	rel.	2734	2190	1351	378	1480	3765	1545	410	1635 -

The unsupported lengths for the HEB beams are small, as a result of which stability is not governing. Thus, for the purpose of conciseness stability calculation was done roughly for H beams and not shown in this report.

The bottom chords of the cross arms are checked for bending. The figures and tables for the internal forces can be found in the above-mentioned appendix. The torsion in the bottom chord, shown in figure 6 is less than 0.8 and can be neglected. Therefore, stress check in AxisVM is acceptable.

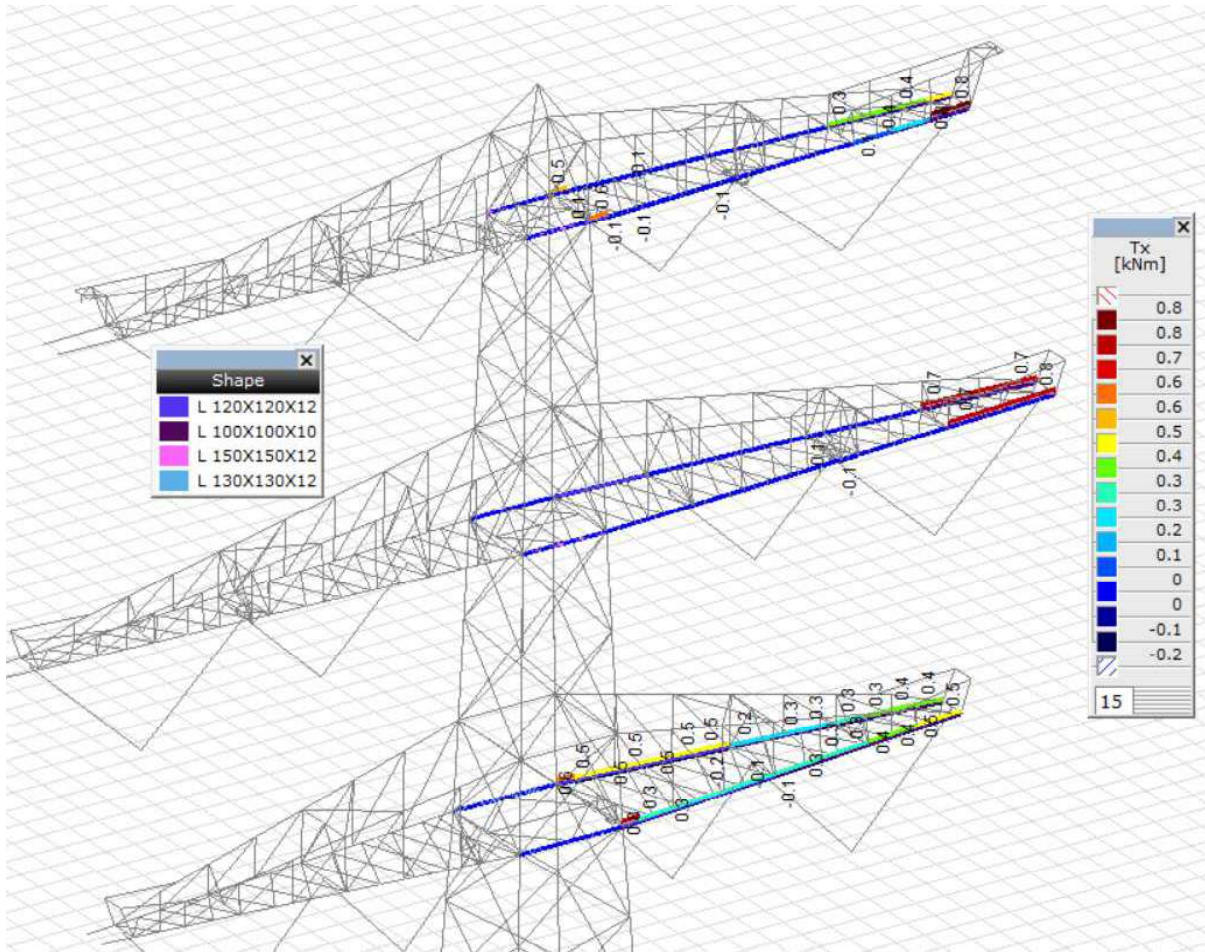

Figure 6 Torsion in bottom chord of the cross arms

The maximum stress in the bottom chord members is 274 N/mm². This occurs in the low cross arm. The max stress is within the yield limit of 355 N/mm² for S355 grade steel. PLS tower showed a utility ratio of around 50% for a section of 100x100x10 profiles as the bottom chord of the LCA. However, this profile was not adequate as the combined stress including the effects of bending exceed the yield limit. Thus, the size was increases to 120x120x12 angle profile. The stress in the bottom chord is shown in Figure 7. The stresses are considered to have a safe margin below the yield limit.

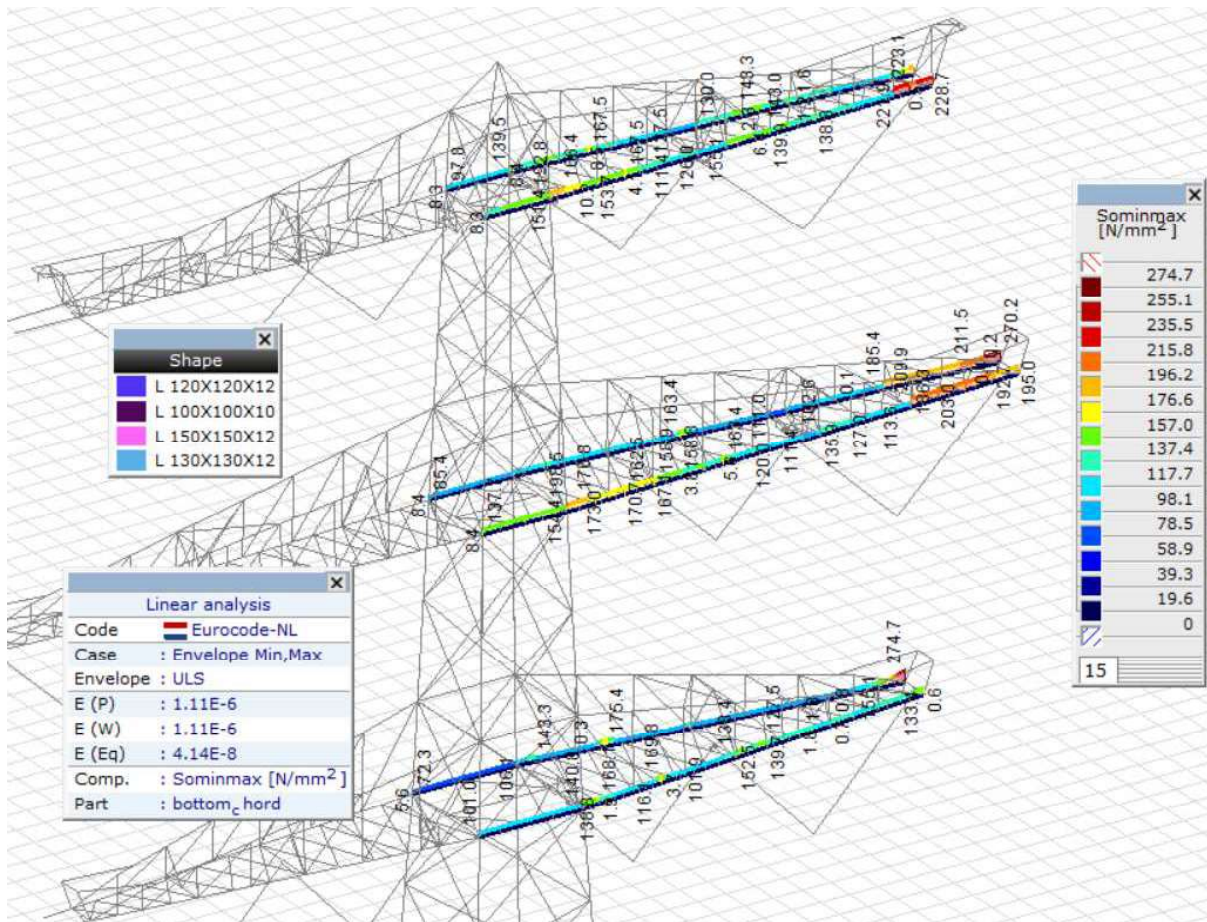

Figure 7 stress in the bottom chord for envelop of forces.

1.4 Conclusion:

Load scenarios impose torsional load in the structure. PLS tower is incapable of checking for torsion and bending. The beams supporting the insulators and the bottom chord of the cross arms are checked for bending and torsion in AxisVM application. The loads are taken from PLS tower. The results of the analysis in AxisVM post processing show large torsion in beams for hoisting and the beams of the insulator assembly. Furthermore, the stress calculation of Axis does not consider the warping moment due to torsion. Therefore, excel calculation is made to check the beams with considerable torsion. All the HEB- and HEA-beams are found to have stresses within the permissible limit of yield stress.

The profiles for the H beams housing the insulator assemblies are adequate and shown in figure 8.

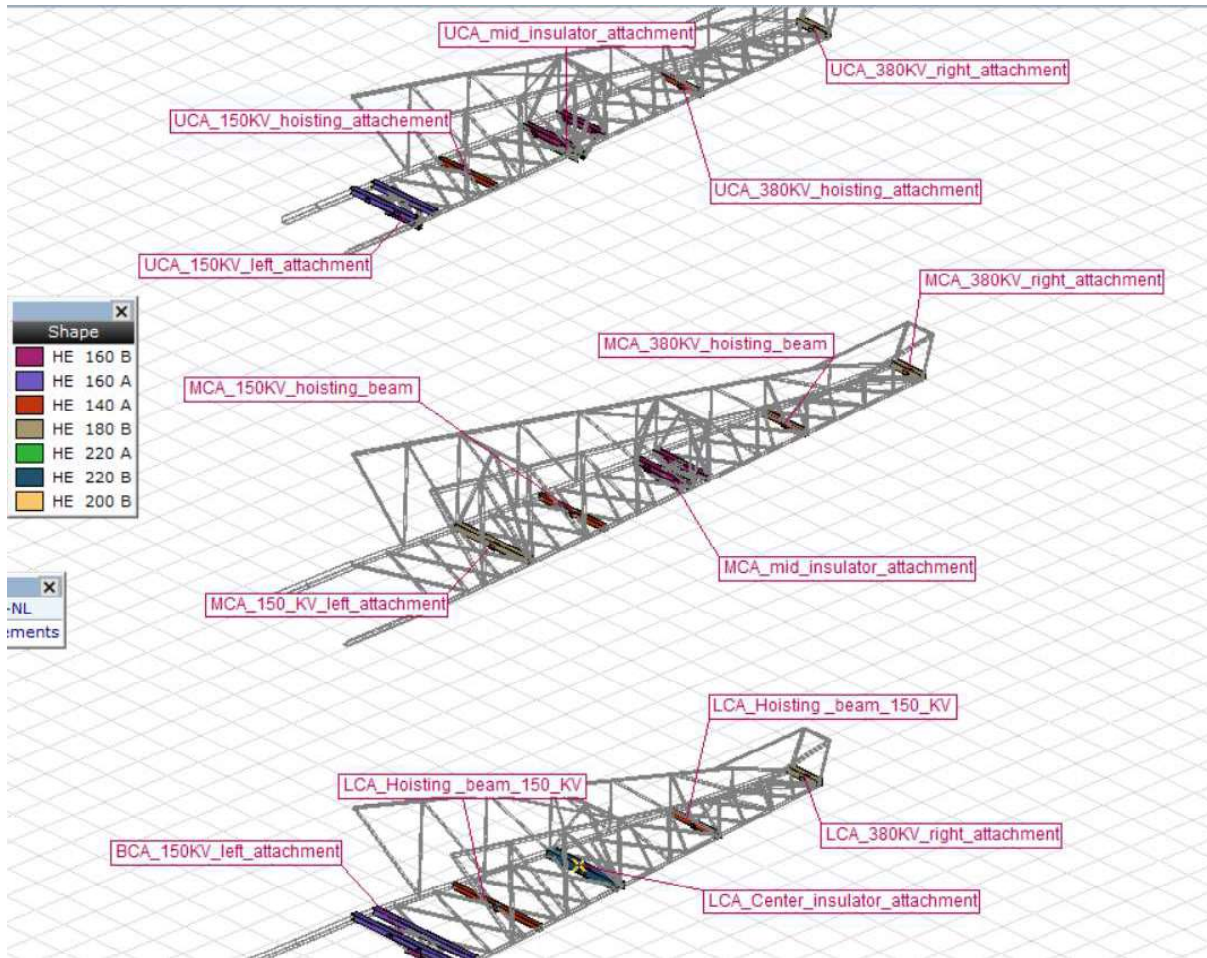

Figure 8 Profiles for the H beams

The bottom chord members do not develop torsion. Therefore, stresses calculated by AxisVM are accurate. The stress in the bottom chord from AxisVM post processing are below the yield limit. The utility ratio for the bottom chord is less than 0.70. The reserve capacity is adequate for stability considerations.

Appendix: report AxisVM

Project

Analysis by

AxisVM X5 R4h - Registered to DNV GL - Energy
S+Q_combi,axs

Report

Item	Page
model_views	4
Materials	4
Cross-sections	4
3D view and cross_section_detail	6
Spring characteristics	6
Nodal supports [Insulators_assembly]	7
Lower cross arm details with dimensions	8
LCA left 150KV	8
LCA Mid 150 380 KV	9
LCA right 380 KV	9
Mid cross arm details	10
MCA 150KV left attachment	10
MCA 380KV right attachment	11
MCA_mid_attachment (1) cross-section_orientation (2) dimension	11
Upper cross arms details	12
UCA 150 KV left attachment (1)crosssection_shape (2)dimensions	12
UCA 150KV hoisting beam details	13
UCA mid attachment (1)crosssection shape (2)dimensions	13
UCA 380KV right attachment detils	14
> Load nodes ID	15
1a_90: Nodal loads [Load nodes]	15
> Load nodes, 1a_90, Side view	15
1a_270: Nodal loads [Load nodes]	15
> Load nodes, 1a_270, Side view	16
3_90: Nodal loads [Load nodes]	16
> Load nodes, 3_90, Side view	16
3_270: Nodal loads [Load nodes]	16
> Load nodes, 3_270, Side view	17
5a_01: Nodal loads [Load nodes]	17
> Load nodes, 5a_01, Side view	17
5a_10: Nodal loads [Load nodes]	17
> Load nodes, 5a_10, Side view	18
5a_11: Nodal loads [Load nodes]	18
> Load nodes, 5a_11, Side view	18
5a_12: Nodal loads [Load nodes]	18
> Load nodes, 5a_12, Side view	19
5a_30: Nodal loads [Load nodes]	19
> Load nodes, 5a_30, Side view	19
5a_31: Nodal loads [Load nodes]	19
> Load nodes, 5a_31, Side view	20
5a_32: Nodal loads [Load nodes]	20
> Load nodes, 5a_32, Side view	20
hoisting_Load: Nodal loads [Load nodes]	20
> Load nodes, hoisting_Load, Side view	21
hoisting_Load_reverse: Nodal loads [Load nodes]	21
> Load nodes, hoisting_Load_reverse, Side view	21
144_SLS_1a_90_1: Nodal loads [Load nodes]	21
> Load nodes, 144_SLS_1a_90_1, Side view	22
144_SLS_1a_270_1: Nodal loads [Load nodes]	22
> Load nodes, 144_SLS_1a_270_1, Side view	22
145_SLS_3_90: Nodal loads [Load nodes]	23
> Load nodes, 145_SLS_3_90, Side view	23
145_SLS_3_270: Nodal loads [Load nodes]	23
> Load nodes, 145_SLS_3_270, Side view	23
Custom load combinations by load cases	24
> bottom_chord	25
Nodal displacements [Linear, Envelope (Default), LCA]	25
LCA_bottom_chord, Linear, Envelope (Default), eZ [mm], Diagram	25
Beam internal forces [Linear, Envelope (Default), LCA]	26
LCA_bottom_chord, Linear, Envelope (Default), Nx [kN], Filled diagram	26
LCA_bottom_chord, Linear, Envelope (Default), My [kNm], Filled diagram	26
LCA_bottom_chord, Linear, Envelope (Default), Mz [kNm], Filled diagram	27
LCA_bottom_chord, Linear, Envelope (ULS), Vz [kN], Filled diagram	27
Beam stresses [Linear, Envelope (Default), LCA]	28
LCA_bottom_chord, Linear, Envelope (Default), Sominmax [N/mm^2], Filled diagram	28
Nodal displacements [Linear, Envelope (Default), MCA]	28
MCA_bottom_chord, Linear, Envelope (Default), eZ [mm], Diagram	29
Beam internal forces [Linear, Envelope (Default), MCA]	29
MCA_bottom_chord, Linear, Envelope (Default), Nx [kN], Filled diagram	29
MCA_bottom_chord, Linear, Envelope (Default), My [kNm], Filled diagram	30
MCA_bottom_chord, Linear, Envelope (Default), Mz [kNm], Filled diagram	30
MCA_bottom_chord, Linear, Envelope (ULS), Vz [kN], Filled diagram	31
Beam stresses [Linear, Envelope (Default), MCA]	31
MCA_bottom_chord, Linear, Envelope (Default), Sominmax [N/mm^2], Filled diagram	32
Nodal displacements [Linear, Envelope (Default), UCA]	32
UCA_bottom_chord, Linear, Envelope (Default), eZ [mm], Diagram	32
Beam internal forces [Linear, Envelope (Default), UCA]	33
UCA_bottom_chord, Linear, Envelope (Default), Nx [kN], Filled diagram	33
UCA_bottom_chord, Linear, Envelope (Default), My [kNm], Filled diagram	33
UCA_bottom_chord, Linear, Envelope (Default), Mz [kNm], Filled diagram	34
UCA_bottom_chord, Linear, Envelope (ULS), Vz [kN], Filled diagram	34
Beam stresses [Linear, Envelope (Default), UCA]	35
UCA_bottom_chord, Linear, Envelope (Default), Sominmax [N/mm^2], Filled diagram	35
Beam internal forces [Linear, Envelope (Default), Insulators_assembly]	36
BCA_150KV_left_attachment_Linear, Envelope (Default), My [kNm], Filled diagram	46
BCA_150KV_left_attachment_Linear, Envelope (Default), Mz [kNm], Filled diagram	47
BCA_150KV_left_attachment_Linear, Envelope (Default), Tx [kNm], Filled diagram	47
BCA_Center_insulator_attachment_Linear, Envelope (Default), My [kNm], Filled diagram	48
BCA_Center_insulator_attachment_Linear, Envelope (Default), Mz [kNm], Filled diagram	48
BCA_Center_insulator_attachment_Linear, Envelope (Default), Tx [kNm], Filled diagram	49
BCA_380KV_right_attachment_Linear, Envelope (Default), My [kNm], Filled diagram	49
BCA_380KV_right_attachment_Linear, Envelope (Default), Mz [kNm], Filled diagram	50
BCA_380KV_right_attachment_Linear, Envelope (Default), Tx [kNm], Filled diagram	50
MCA_150_KV_left_attachment_Linear, Envelope (Default), My [kNm], Filled diagram	51
MCA_150_KV_left_attachment_Linear, Envelope (Default), Mz [kNm], Filled diagram	51
MCA_150_KV_left_attachment_Linear, Envelope (Default), Tx [kNm], Filled diagram	52
MCA_mid_insulator_attachment_Linear, Envelope (Default), My [kNm], Filled diagram	52

<i>Item</i>	<i>Page</i>
MCA_mid_insulator_attachment_Linear,Envelope (Default), Mz [kNm], Filled diagram	53
MCA_mid_insulator_attachment_Linear,Envelope (Default), Tx [kNm], Filled diagram	53
MCA_380KV_right_attachement_Linear,Envelope (Default), My [kNm], Filled diagram	54
MCA_380KV_right_attachement_Linear,Envelope (Default), Mz [kNm], Filled diagram	54
MCA_380KV_right_attachement_Linear,Envelope (Default), Tx [kNm], Filled diagram	55
UCA_150KV_left_attachement_Linear,Envelope (Default), My [kNm], Filled diagram	55
UCA_150KV_left_attachement_Linear,Envelope (Default), Mz [kNm], Filled diagram	56
UCA_150KV_left_attachement_Linear,Envelope (Default), Tx [kNm], Filled diagram	56
UCA_150KV_hoisting_attachement_Linear,Envelope (Default), My [kNm], Filled diagram	57
UCA_150KV_hoisting_attachement_Linear,Envelope (Default), Mz [kNm], Filled diagram	57
UCA_150KV_hoisting_attachement_Linear,Envelope (Default), Tx [kNm], Filled diagram	58
UCA_mid_insulator_attachement_Linear,Envelope (Default), My [kNm], Filled diagram	58
UCA_mid_insulator_attachement_Linear,Envelope (Default), Mz [kNm], Filled diagram	59
UCA_mid_insulator_attachement_Linear,Envelope (Default), Tx [kNm], Filled diagram	59
UCA_380KV_right_attachement_Linear,Envelope (Default), My [kNm], Filled diagram	60
UCA_380KV_right_attachement_Linear,Envelope (Default), Mz [kNm], Filled diagram	60
UCA_380KV_right_attachement_Linear,Envelope (Default), Tx [kNm], Filled diagram	61

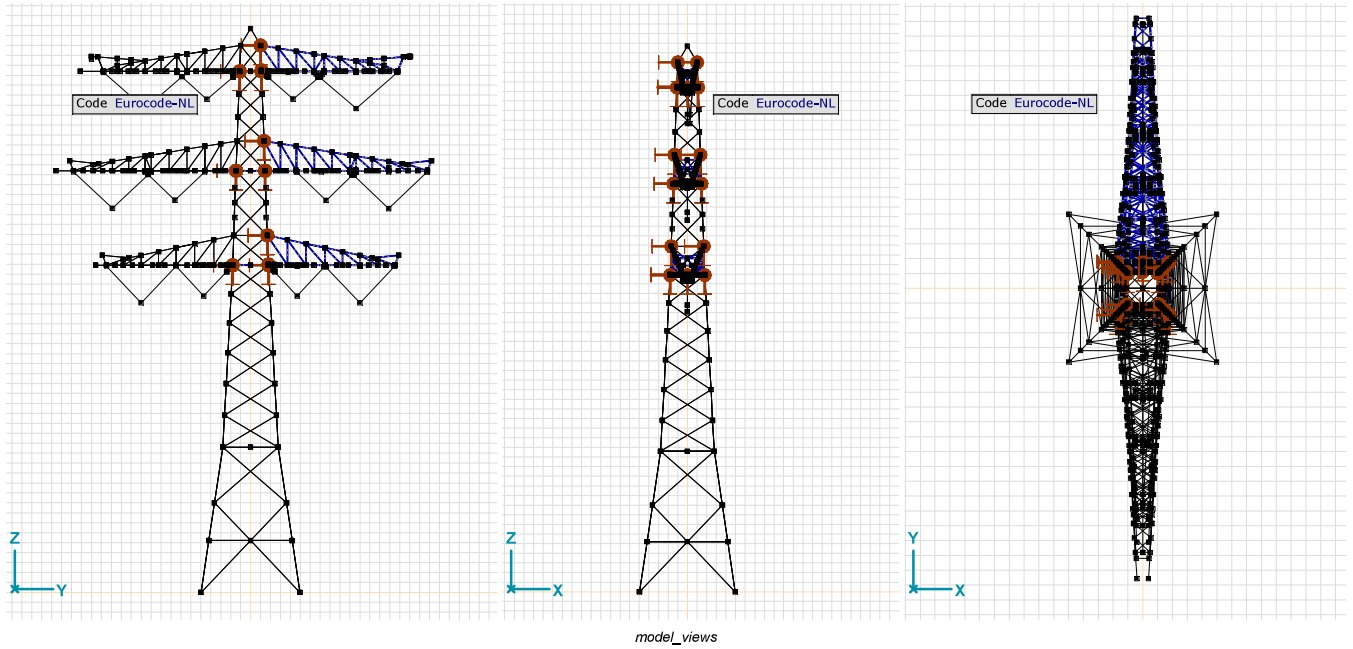

Materials

	Name	Type	National design code	Material code	Model	E_x [N/mm ²]	E_y [N/mm ²]	ν	α_T [1/°C]	ρ [kg/m ³]	Material color	Contour color	Texture
1	S 355	Steel	Eurocode-NL	10025-2	Plastic	210000	210000	0.30	1.2E-5	7850	■	■	Steel

	Name	P_1	P_2	P_3	P_4	P_5	P_6	P_7	P_8	P_9	P_{10}	P_{11}	P_{12}	P_{13}	P_{14}
1	S 355	f_u [N/mm ²] = 355.00	f_u [N/mm ²] = 510.00	f_c [N/mm ²] = 335.00	f_c [N/mm ²] = 470.00										

Name: Material name; Type: Type of material; Model: Material model; E_x : Young's modulus of elasticity in local x direction; E_y : Young's modulus of elasticity in local y direction; ν : Poisson's ratio; α_T : Thermal expansion coefficient; ρ : Density; Contour color: Material outline color; $P_1, P_2, P_3, P_4, P_5, P_6, P_7, P_8, P_9, P_{10}, P_{11}, P_{12}, P_{13}, P_{14}$: Design parameter;













Cross-sections

	Name	Drawing	Process	Shape	h [mm]	b [mm]	t_w [mm]	t_f [mm]	r_1 [mm]	r_2 [mm]	r_3 [mm]	A_x [mm ²]	A_y [mm ²]	A_z [mm ²]	I_x [mm ⁴]	I_y [mm ⁴]	I_z [mm ⁴]
1	HE 160 A		Rolled	I	152.0	160.0	6.0	9.0	15.0	0	0	3878.04	2636.55	888.57	121366.2	1.7E+07	6155809.0
2	L 60X 60X 6		Rolled	L	60.0	60.0	6.0	6.0	8.0	4.0	0	690.90	302.80	306.64	9044.2	227898.9	227898.9
3	U 120		Rolled	U	120.0	55.0	7.0	9.0	9.0	4.5	0	1698.73	617.80	752.09	41830.7	3643327.0	430614.1
4	L 50X 50X 5		Rolled	L	50.0	50.0	5.0	5.0	7.0	3.5	0	480.28	210.38	213.29	4408.9	109629.1	109629.1
5	HE 220 A		Rolled	I	210.0	220.0	7.0	11.0	18.0	0	0	6435.42	4367.99	1424.01	287198.6	5.4E+07	2E+07

	Name	I_{yz} [mm ⁴]	I_1 [mm ⁴]	I_2 [mm ⁴]	α [°]	I_{ω} [mm ⁶]	$W_{1,el,t}$ [mm ³]	$W_{1,el,b}$ [mm ³]	$W_{2,el,t}$ [mm ³]	$W_{2,el,b}$ [mm ³]	$W_{1,pl}$ [mm ³]	$W_{2,pl}$ [mm ³]	i_y [mm]	i_z [mm]
1	HE 160 A	0	1.7E+07	6155809.0	0	3.1E+10	220173.4	220173.4	76947.6	76947.6	245202.6	117640.1	65.7	39.8
2	L 60X 60X 6	-133497.7	361396.6	94401.2	45.00	2037188	8518.2	8518.2	4463.6	3956.0	13554.5	6989.1	18.2	18.2
3	U 120	0	3643327.0	430614.1	0	8.9E+08	60722.1	60722.1	11058.3	26813.4	72702.6	21257.6	46.3	15.9
4	L 50X 50X 5	-64162.8	173791.9	45466.3	45.00	678722	4915.6	4915.6	2584.4	2290.7	7830.3	4045.4	15.1	15.1
5	HE 220 A	0	5.4E+07	2E+07	0	1.9E+11	515304.0	515304.0	177688.9	177688.9	568570.3	270607.6	91.7	55.1

	Name	H_y [mm]	H_z [mm]	y_G [mm]	z_G [mm]	y_s [mm]	z_s [mm]	S_p
1	HE 160 A	160.0	152.0	80.0	76.0	0	0	9
2	L 60X 60X 6	60.0	60.0	16.9	16.9	-13.3	-13.3	4
3	U 120	55.0	120.0	16.1	60.0	-29.6	0	8
4	L 50X 50X 5	50.0	50.0	14.0	14.0	-11.0	-11.0	4
5	HE 220 A	220.0	210.0	110.0	105.0	0	0	9

Cross-sections

	Name	Drawing	Process	Shape	h [mm]	b [mm]	tw [mm]	tf [mm]	r ₁ [mm]	r ₂ [mm]	r ₃ [mm]	A _x [mm ²]	A _y [mm ²]	A _z [mm ²]	I _x [mm ⁴]	I _y [mm ⁴]	I _z [mm ⁴]
6	L 120X120X12		Rolled	L	120.0	120.0	12.0	12.0	13.0	6.5	0	2754.22	1208.71	1219.23	139579.2	3676399.0	3676399.0
7	HE 200 B		Rolled	I	200.0	200.0	9.0	15.0	18.0	0	0	7809.42	5398.31	1742.91	606300.8	5.7E+07	2E+07
8	L 100X100X10		Rolled	L	100.0	100.0	10.0	10.0	12.0	6.0	0	1915.52	840.25	849.06	68400.0	1766604.0	1766604.0
9	L 70X 70X 7		Rolled	L	70.0	70.0	7.0	7.0	9.0	4.5	0	939.73	412.00	416.89	16632.0	422933.4	422933.4
10	L 80X 80X 8		Rolled	L	80.0	80.0	8.0	8.0	10.0	5.0	0	1226.78	537.99	544.05	28221.9	722397.8	722397.8
11	L 70X 70X 6		Rolled	L	70.0	70.0	6.0	6.0	9.0	4.5	0	812.73	352.06	356.95	10739.9	368795.6	368795.6
12	L 55X 55X 6		Rolled	L	55.0	55.0	6.0	6.0	8.0	4.0	0	630.90	278.51	282.29	8324.3	172850.1	172850.2
13	HE 140 A		Rolled	I	133.0	140.0	5.5	8.5	12.0	0	0	3142.19	2147.66	704.86	81932.8	1E+07	3893251.0
14	L 80X 80X 6		Rolled	L	80.0	80.0	6.0	6.0	10.0	5.0	0	934.78	402.15	407.43	12473.9	558166.2	558166.2
15	HE 180 B		Rolled	I	180.0	180.0	8.5	14.0	15.0	0	0	6526.04	4497.99	1465.41	428543.6	3.8E+07	1.4E+07
16	HE 160 B		Rolled	I	160.0	160.0	8.0	13.0	15.0	0	0	5426.04	3754.44	1237.48	317826.3	2.5E+07	8892444.0
17	L 45X 45X 5		Rolled	L	45.0	45.0	5.0	5.0	7.0	3.5	0	430.28	190.17	193.02	3992.0	78398.8	78398.7
18	L 90X 90X 9		Rolled	L	90.0	90.0	9.0	9.0	11.0	5.5	0	1552.04	680.71	688.10	45021.7	1158223.0	1158223.0

	Name	I _{yz} [mm ⁴]	I ₁ [mm ⁴]	I ₂ [mm ⁴]	α [°]	I _ω [mm ⁶]	W _{1,el,t} [mm ³]	W _{1,el,b} [mm ³]	W _{2,el,t} [mm ³]	W _{2,el,b} [mm ³]	W _{1,pl} [mm ³]	W _{2,pl} [mm ³]	i _y [mm]	i _z [mm]
6	L 120X120X12	-2160249.0	5836648.0	1516150.0	45.00	1.3E+08	68785.5	68785.5	35578.9	31565.4	109074.8	55859.7	36.5	36.5
7	HE 200 B	0	5.7E+07	2E+07	0	1.7E+11	569697.5	569697.5	200338.9	200338.9	642648.6	305826.5	85.4	50.6
8	L 100X100X10	-1036581.0	2803186.0	730023.0	45.00	4.4E+07	39643.0	39643.0	20631.6	18290.5	62957.8	32342.2	30.4	30.4
9	L 70X 70X 7	-247895.0	670828.4	175038.4	45.00	5155803	13552.8	13552.8	7084.6	6279.1	21550.0	11096.7	21.2	21.2
10	L 80X 80X 8	-423612.4	1146010.0	298785.4	45.00	1.2E+07	20258.8	20258.8	10570.7	9369.6	32196.1	16562.3	24.3	24.3
11	L 70X 70X 6	-216123.7	584919.3	152671.9	45.00	3333474	11817.2	11817.2	6203.4	5599.5	18692.5	9653.0	21.3	21.3
12	L 55X 55X 6	-101063.0	273913.2	71787.1	45.00	1527235	7043.1	7043.1	3705.3	3247.9	11266.6	5820.9	16.6	16.6
13	HE 140 A	0	1E+07	3893251.0	0	1.5E+10	155382.8	155382.8	55617.9	55617.9	173525.9	84852.6	57.3	35.2
14	L 80X 80X 6	-326876.9	885043.1	231289.3	45.00	5085144	15645.5	15645.5	8233.3	7546.6	24644.0	12753.5	24.4	24.4
15	HE 180 B	0	3.8E+07	1.4E+07	0	9.2E+10	425731.4	425731.4	151428.6	151428.6	481510.9	231022.2	76.6	45.7
16	HE 160 B	0	2.5E+07	8892443.0	0	4.7E+10	311542.7	311542.7	111155.5	111155.5	354020.6	169972.2	67.8	40.5
17	L 45X 45X 5	-45786.5	124185.2	32612.3	45.00	478168	3902.8	3902.8	2062.0	1802.8	6258.0	3240.6	13.5	13.5
18	L 90X 90X 9	-679416.3	1837639.0	478806.7	45.00	2.3E+07	28875.7	28875.7	15045.3	13336.8	45872.2	23579.5	27.3	27.3

	Name	H _y [mm]	H _z [mm]	y _G [mm]	z _G [mm]	y _s [mm]	z _s [mm]	S.p.
6	L 120X120X12	120.0	120.0	34.0	34.0	-27.0	-27.0	4
7	HE 200 B	200.0	200.0	100.0	100.0	0	0	9
8	L 100X100X10	100.0	100.0	28.2	28.2	-22.3	-22.3	4
9	L 70X 70X 7	70.0	70.0	19.7	19.7	-15.5	-15.5	4
10	L 80X 80X 8	80.0	80.0	22.5	22.5	-17.8	-17.8	4
11	L 70X 70X 6	70.0	70.0	19.3	19.3	-15.7	-15.7	4
12	L 55X 55X 6	55.0	55.0	15.6	15.6	-12.0	-12.0	4
13	HE 140 A	140.0	133.0	70.0	66.5	0	0	9
14	L 80X 80X 6	80.0	80.0	21.7	21.7	-18.1	-18.1	4
15	HE 180 B	180.0	180.0	90.0	90.0	0	0	9
16	HE 160 B	160.0	160.0	80.0	80.0	0	0	9
17	L 45X 45X 5	45.0	45.0	12.8	12.8	-9.7	-9.7	4
18	L 90X 90X 9	90.0	90.0	25.4	25.4	-20.0	-20.0	4

Cross-sections

	Name	Drawing	Process	Shape	h [mm]	b [mm]	tw [mm]	tf [mm]	r ₁ [mm]	r ₂ [mm]	r ₃ [mm]	Ax [mm ²]	Ay [mm ²]	Az [mm ²]	I _x [mm ⁴]	I _y [mm ⁴]	I _z [mm ⁴]
19	L 100X 50X 6X		Rolled	L	100.0	50.0	6.0	6.0	9.0	4.5	0	872.73	231.48	516.47	11460.0	897072.9	152537.5
20	L 150X150X12		Rolled	L	150.0	150.0	12.0	12.0	16.0	8.0	0	3483.60	1505.64	1521.61	179274.1	7368515.0	7368513.0
21	L 130X130X12		Rolled	L	130.0	130.0	12.0	12.0	14.0	7.0	0	2997.13	1307.44	1319.65	152690.7	4721381.0	4721382.0
22	U 160_double		Rolled	Custom	160.0	264.0	7.5	10.5	10.5	5.5	0	5472.91	896.17	1978.17	141469.7	1.8E+07	3.8E+07
23	HE 220 B		Rolled	I	220.0	220.0	9.5	16.0	18.0	0	0	9105.42	6276.26	2008.65	781768.1	8.1E+07	2.8E+07

	Name	I _{yz} [mm ⁴]	I ₁ [mm ⁴]	I ₂ [mm ⁴]	α [°]	I _ω [mm ⁶]	W _{1,el,t} [mm ³]	W _{1,el,b} [mm ³]	W _{2,el,t} [mm ³]	W _{2,el,b} [mm ³]	W _{1,pl} [mm ³]	W _{2,pl} [mm ³]	i _y [mm]	i _z [mm]
19	L 100X 50X 6X	-207618.9	951054.9	98555.4	14.57	5624540	14496.4	21734.5	3281.0	5221.4	25285.3	7359.8	32.1	13.2
20	L 150X150X12	-4334081.0	1.2E+07	3034433.0	45.00	2.7E+08	110333.1	110333.1	57321.5	52048.1	173526.6	89044.1	46.0	46.0
21	L 130X130X12	-2776282.0	7497663.0	1945100.0	45.00	1.7E+08	81563.8	81563.8	42243.5	37794.8	128920.4	66052.0	39.7	39.7
22	U 160_double	0	3.8E+07	1.8E+07	90.00	4.9E+10	285822.3	285822.3	231205.9	231205.9	432594.1	275916.0	58.1	83.0
23	HE 220 B	0	8.1E+07	2.8E+07	0	2.9E+11	735632.5	735632.5	258480.6	258480.6	827160.4	393895.7	94.3	55.9

	Name	H _y [mm]	H _z [mm]	y _G [mm]	z _G [mm]	y _s [mm]	z _s [mm]	S.p.
19	L 100X 50X 6X	50.0	100.0	10.4	34.9	-7.3	-30.2	4
20	L 150X150X12	150.0	150.0	41.2	41.2	-34.2	-34.2	4
21	L 130X130X12	130.0	130.0	36.4	36.4	-29.4	-29.4	4
22	U 160_double	264.0	160.0	132.0	80.0	0	0	9
23	HE 220 B	220.0	220.0	110.0	110.0	0	0	9

Name: Cross-section name; Process: Manufacturing process; h: Cross-section height; b: Cross-section width; tw: Web thickness; tf: Flange thickness; r₁, r₂, r₃: Rounding radius; Ax: Cross-section area; Ay, Az: Shear area; I_x: Torsional inertia; I_y, I_z: Flexural inertia; I_{yz}: Centrifugal inertia; I₁, I₂: Principal flexural inertia; α: Principal directions; I_ω: Warping constant; W_{1,el,t}, W_{1,el,b}, W_{2,el,t}, W_{2,el,b}: Elastic modulus; W_{1,pl}, W_{2,pl}: Plastic modulus; I_y, I_z: Radius of inertia; H_y: Dimension in local y direction; H_z: Dimension in local z direction; y_G: y coordinate of the center of gravity; z_G: z coordinate of the center of gravity; y_s: y coordinate of the shear (torsion) center relative to the center of gravity; z_s: z coordinate of the shear (torsion) center relative to the center of gravity; S.p.: Stress calculation points.

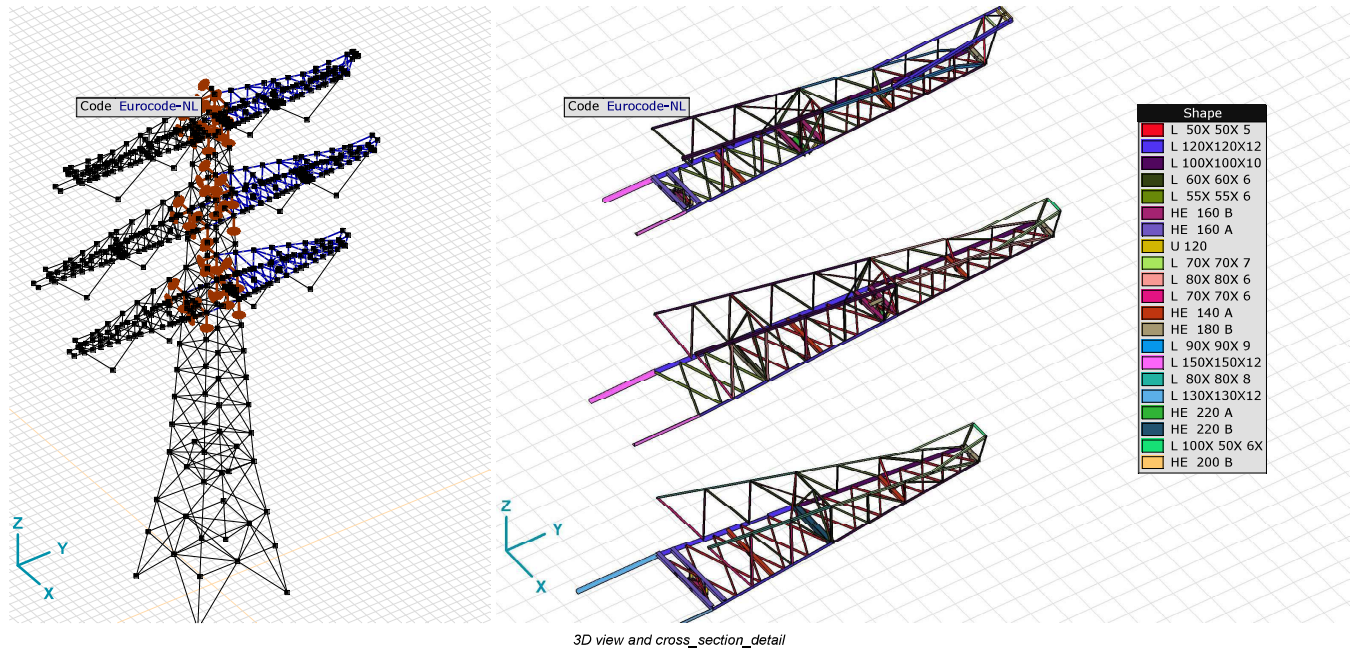

Spring characteristics

	Name	Type	Degree of freedom	Model	K	K _V
1	Soft - Translational	N-N	Translational	Linear	1E+0 kN/m	1E+0 kN/m
2	Rigid - Translational	N-N	Translational	Linear	1E+10 kN/m	1E+10 kN/m
3	Soft - Rotational	N-N	Rotational	Linear	1E+0 kNm/rad	1E+0 kNm/rad
4	Rigid - Rotational	N-N	Rotational	Linear	1E+10 kNm/rad	1E+10 kNm/rad

Name: Name of the spring characteristics; Model: Material model; K: Initial stiffness; K_V: Vibration stiffness;

Nodal supports [Insulators_assembly]

	Node	X [m]	Y [m]	Z [m]
1	60	1.458	1.458	42.400
2	63	-1.458	1.458	42.400
3	56	1.350	1.350	45.400
4	59	-1.350	1.350	45.400
5	66	1.692	1.692	35.900
6	69	-1.692	1.692	35.900
7	39	1.004	1.004	55.000
8	43	-1.004	1.004	55.000
9	44	1.098	1.098	52.400
10	47	-1.098	1.098	52.400
11	70	1.800	1.800	32.900
12	73	-1.800	1.800	32.900
13	110	0	1.800	32.900
14	433	0	1.098	52.400
15	45	1.098	-1.098	52.400
16	46	-1.098	-1.098	52.400
17	61	1.458	-1.458	42.400
18	62	-1.458	-1.458	42.400
19	71	1.800	-1.800	32.900
20	72	-1.800	-1.800	32.900
21	624	1.098	1.098	52.494
22	625	-1.098	1.098	52.494
23	647	1.800	1.800	32.988
24	648	-1.800	1.800	32.988

	Node	Type	Name _x	K _x [kN/m]	K _{x1'} [kN/m]	Name _y	K _y [kN/m]	K _{y1'} [kN/m]	Name _z	K _z [kN/m]	K _{z1'} [kN/m]	Name _{xx}	K _{xx} [kNm/rad]	K _{xx1'} [kNm/rad]
1	60	Glob.	Rigid - Translational	1E+10	1E+10	—	—	—	Rigid - Translational	1E+10	1E+10	—	—	—
2	63	Glob.	Rigid - Translational	1E+10	1E+10	—	—	—	Rigid - Translational	1E+10	1E+10	—	—	—
3	56	Glob.	Rigid - Translational	1E+10	1E+10	Rigid - Translational	1E+10	1E+10	Rigid - Translational	1E+10	1E+10	—	—	—
4	59	Glob.	Rigid - Translational	1E+10	1E+10	Rigid - Translational	1E+10	1E+10	Rigid - Translational	1E+10	1E+10	—	—	—
5	66	Glob.	Rigid - Translational	1E+10	1E+10	Rigid - Translational	1E+10	1E+10	Rigid - Translational	1E+10	1E+10	—	—	—
6	69	Glob.	Rigid - Translational	1E+10	1E+10	Rigid - Translational	1E+10	1E+10	Rigid - Translational	1E+10	1E+10	—	—	—
7	39	Glob.	Rigid - Translational	1E+10	1E+10	Rigid - Translational	1E+10	1E+10	Rigid - Translational	1E+10	1E+10	—	—	—
8	43	Glob.	Rigid - Translational	1E+10	1E+10	Rigid - Translational	1E+10	1E+10	Rigid - Translational	1E+10	1E+10	—	—	—
9	44	Glob.	Rigid - Translational	1E+10	1E+10	—	—	—	Rigid - Translational	1E+10	1E+10	—	—	—
10	47	Glob.	Rigid - Translational	1E+10	1E+10	—	—	—	Rigid - Translational	1E+10	1E+10	—	—	—
11	70	Glob.	Rigid - Translational	1E+10	1E+10	—	—	—	Rigid - Translational	1E+10	1E+10	—	—	—
12	73	Glob.	Rigid - Translational	1E+10	1E+10	—	—	—	Rigid - Translational	1E+10	1E+10	—	—	—
13	110	Glob.	—	—	—	Rigid - Translational	1E+10	1E+10	Rigid - Translational	1E+10	1E+10	—	—	—
14	433	Glob.	—	—	—	Rigid - Translational	1E+10	1E+10	Rigid - Translational	1E+10	1E+10	—	—	—
15	45	Glob.	Rigid - Translational	1E+10	1E+10	Rigid - Translational	1E+10	1E+10	Rigid - Translational	1E+10	1E+10	—	—	—
16	46	Glob.	Rigid - Translational	1E+10	1E+10	Rigid - Translational	1E+10	1E+10	Rigid - Translational	1E+10	1E+10	—	—	—
17	61	Glob.	Rigid - Translational	1E+10	1E+10	Rigid - Translational	1E+10	1E+10	Rigid - Translational	1E+10	1E+10	—	—	—
18	62	Glob.	Rigid - Translational	1E+10	1E+10	Rigid - Translational	1E+10	1E+10	Rigid - Translational	1E+10	1E+10	—	—	—
19	71	Glob.	Rigid - Translational	1E+10	1E+10	Rigid - Translational	1E+10	1E+10	Rigid - Translational	1E+10	1E+10	—	—	—
20	72	Glob.	Rigid - Translational	1E+10	1E+10	Rigid - Translational	1E+10	1E+10	Rigid - Translational	1E+10	1E+10	—	—	—
21	624	Glob.	Rigid - Translational	1E+10	1E+10	—	—	—	—	—	—	—	—	—
22	625	Glob.	Rigid - Translational	1E+10	1E+10	—	—	—	—	—	—	—	—	—
23	647	Glob.	Rigid - Translational	1E+10	1E+10	—	—	—	—	—	—	—	—	—
24	648	Glob.	Rigid - Translational	1E+10	1E+10	—	—	—	—	—	—	—	—	—

	Node	Name _{yy}	K _{yy} [kNm/rad]	K _{yy1'} [kNm/rad]	Name _{zz}	K _{zz} [kNm/rad]	K _{zz1'} [kNm/rad]
1	60	—	—	—	—	—	—
2	63	—	—	—	—	—	—
3	56	—	—	—	—	—	—
4	59	—	—	—	—	—	—
5	66	—	—	—	—	—	—
6	69	—	—	—	—	—	—
7	39	—	—	—	—	—	—
8	43	—	—	—	—	—	—
9	44	—	—	—	—	—	—
10	47	—	—	—	—	—	—
11	70	—	—	—	—	—	—
12	73	—	—	—	—	—	—
13	110	—	—	—	—	—	—
14	433	—	—	—	—	—	—
15	45	—	—	—	—	—	—
16	46	—	—	—	—	—	—
17	61	—	—	—	—	—	—
18	62	—	—	—	—	—	—
19	71	—	—	—	—	—	—
20	72	—	—	—	—	—	—
21	624	—	—	—	—	—	—
22	625	—	—	—	—	—	—
23	647	—	—	—	—	—	—
24	648	—	—	—	—	—	—

Note: Supported node, Type: Support type, Name_x: Name of the spring characteristics, K_x: Initial stiffness, K_{x1'}: Vibration stiffness, Name_y: Name of the spring characteristics, K_y: Initial stiffness, K_{y1'}: Vibration stiffness, Name_z: Name of the spring characteristics, K_z: Initial stiffness, K_{z1'}: Vibration stiffness, Name_{xx}: Name of the spring characteristics, K_{xx}: Initial stiffness, K_{xx1'}: Vibration stiffness, Name_{yy}: Name of the spring characteristics, K_{yy}: Initial stiffness, K_{yy1'}: Vibration stiffness, Name_{zz}: Name of the spring characteristics, K_{zz}: Initial stiffness, K_{zz1'}: Vibration stiffness.

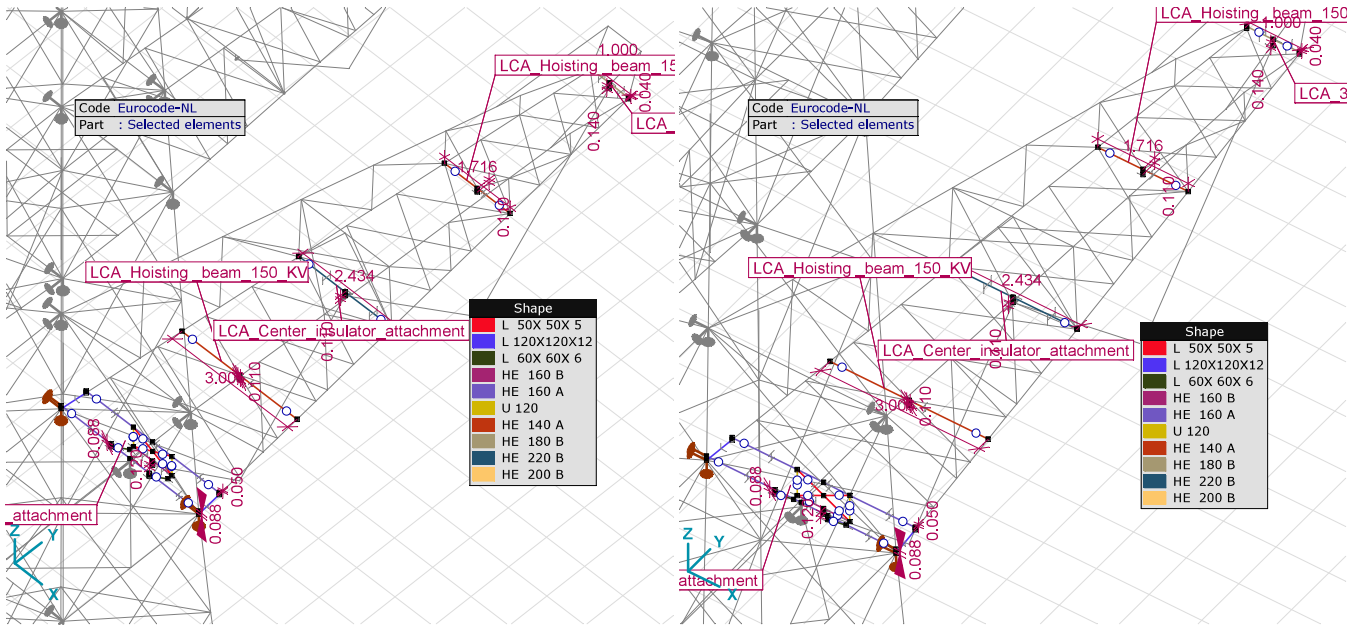

Lower_cross_arm_details_with_dimensions

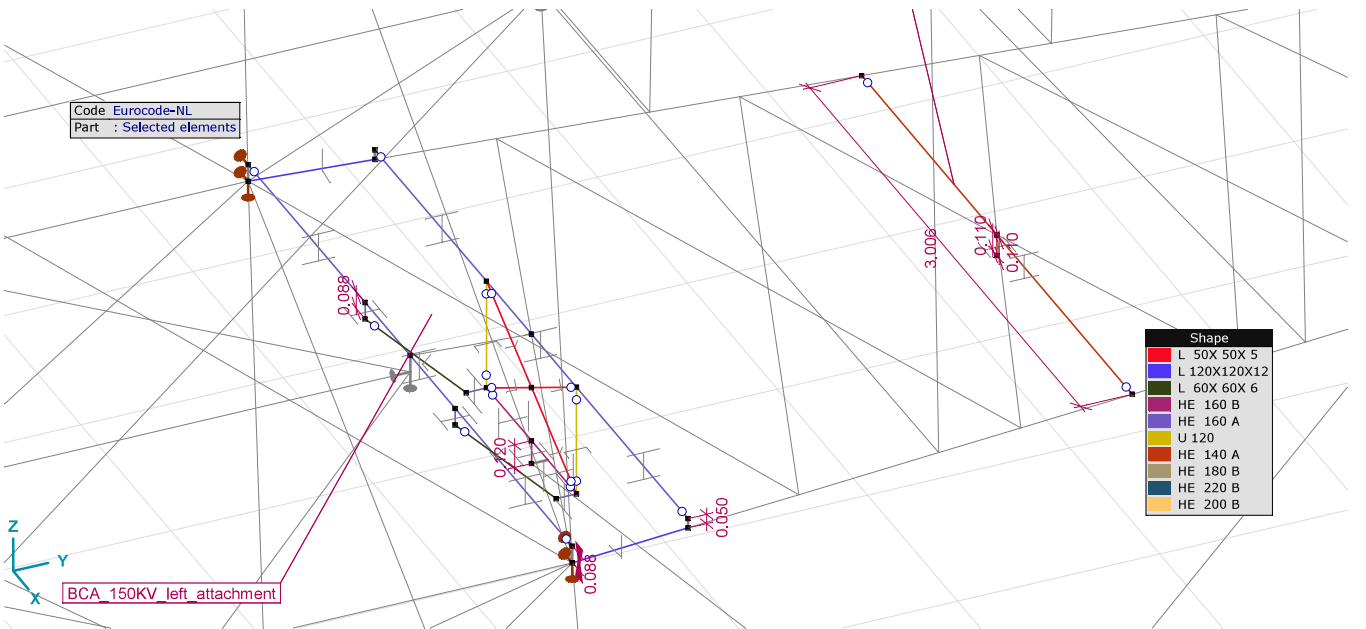

LCA_left_150KV

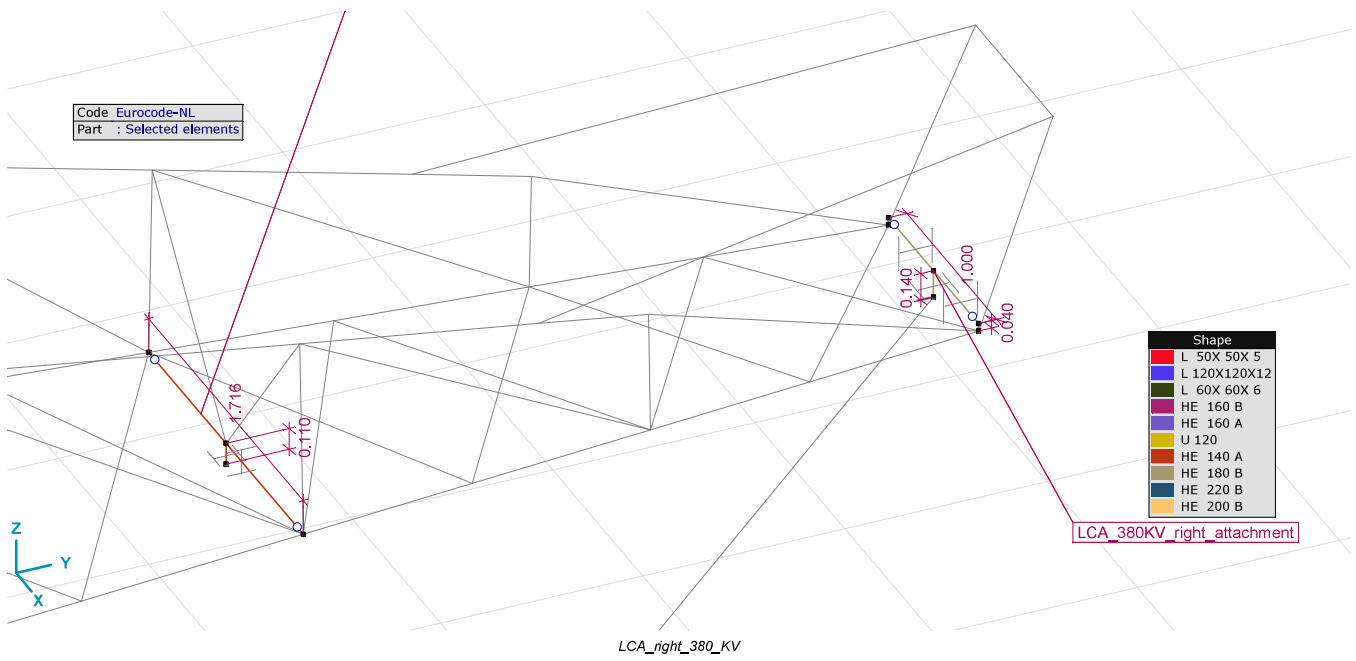
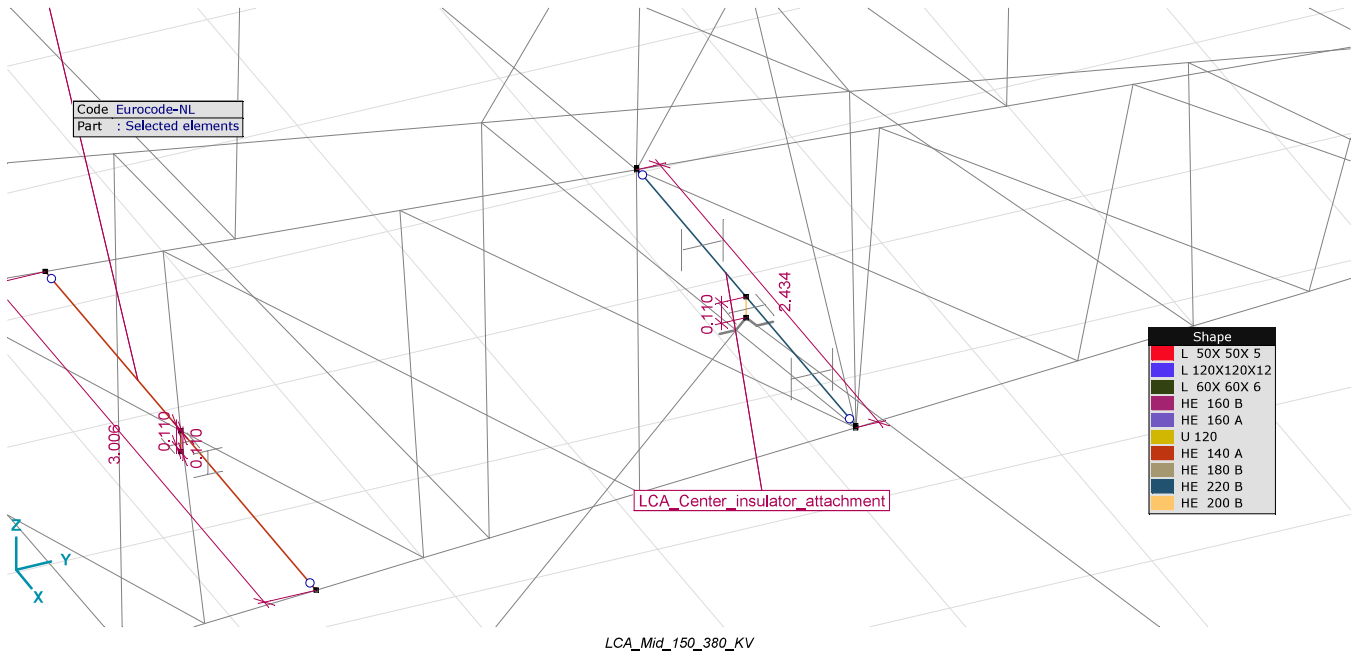

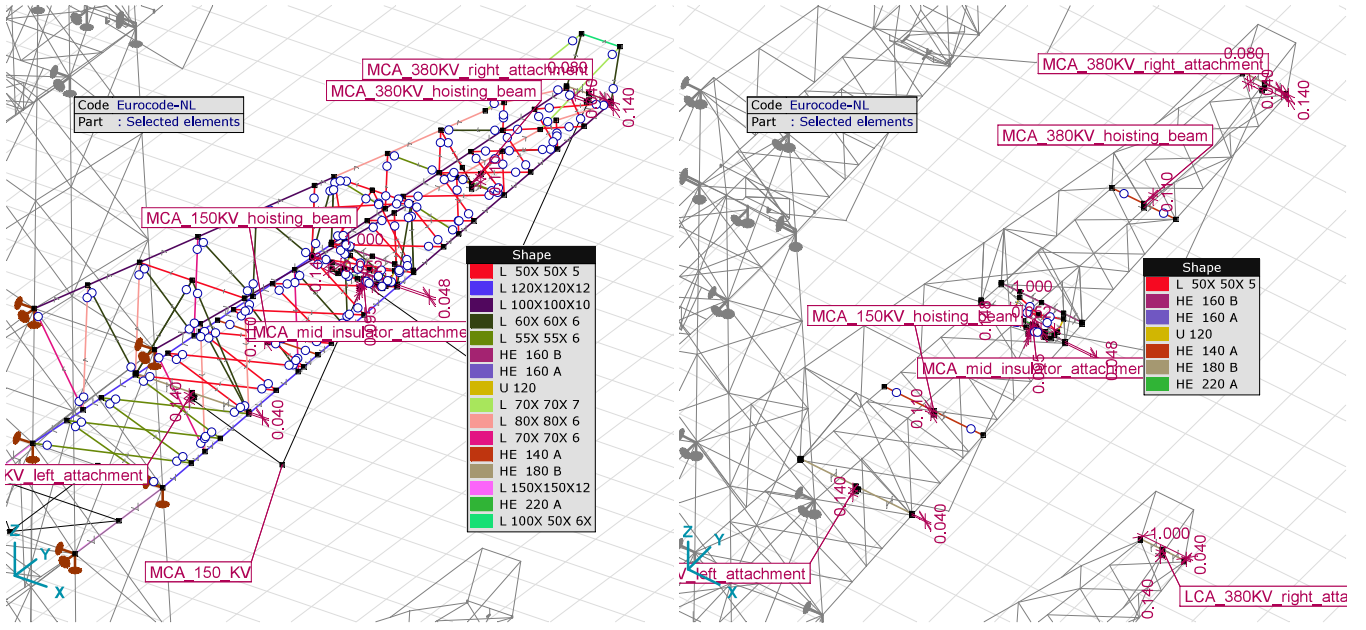

Mid_cross_arm_details

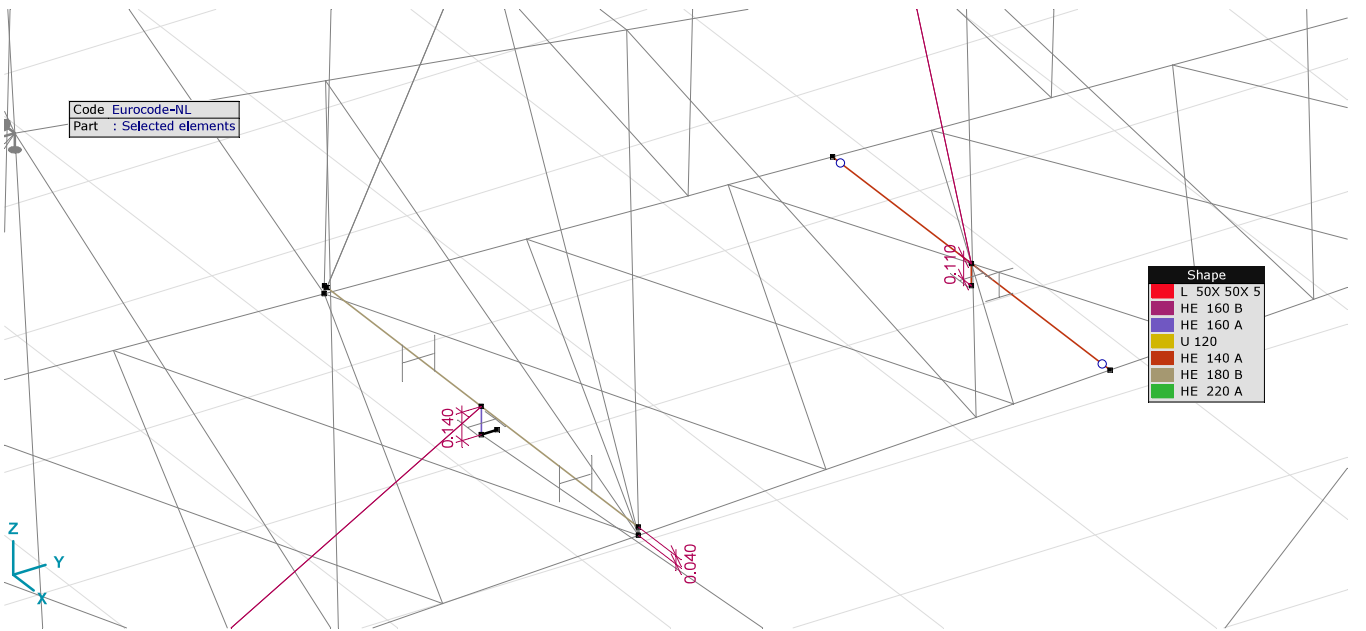

MCA_150KV_left_attachment

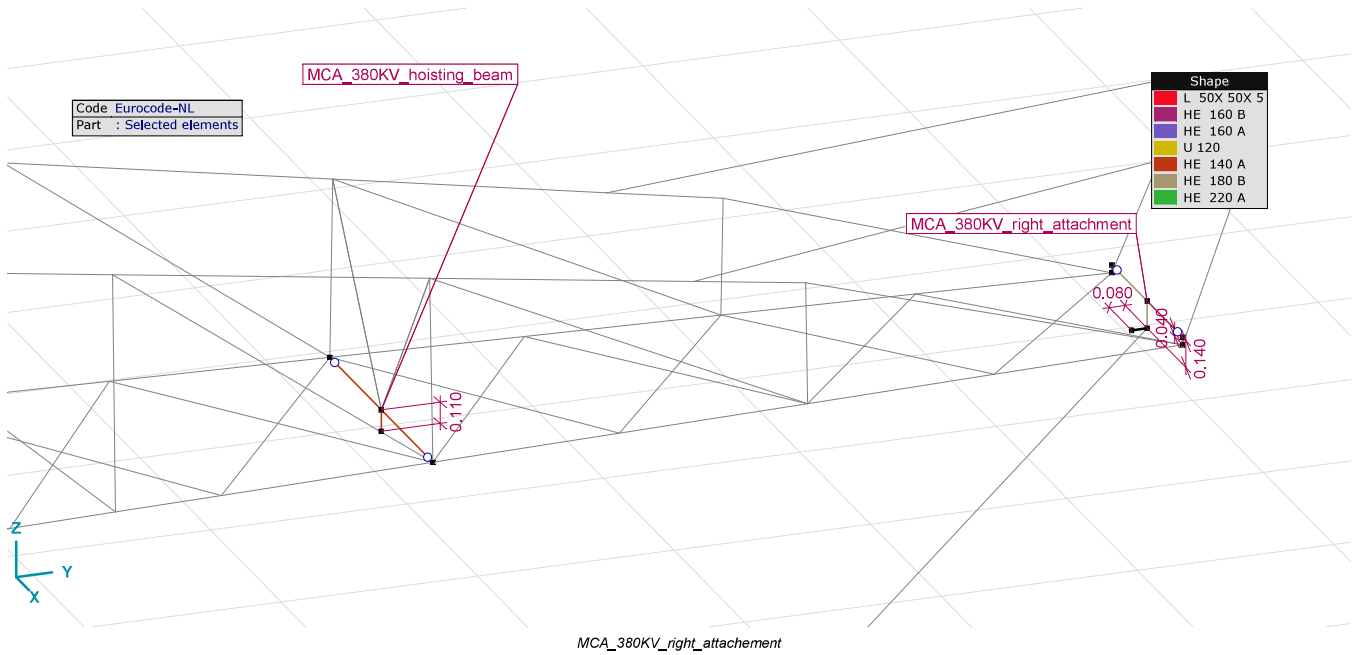

MCA_380KV_right_attachment

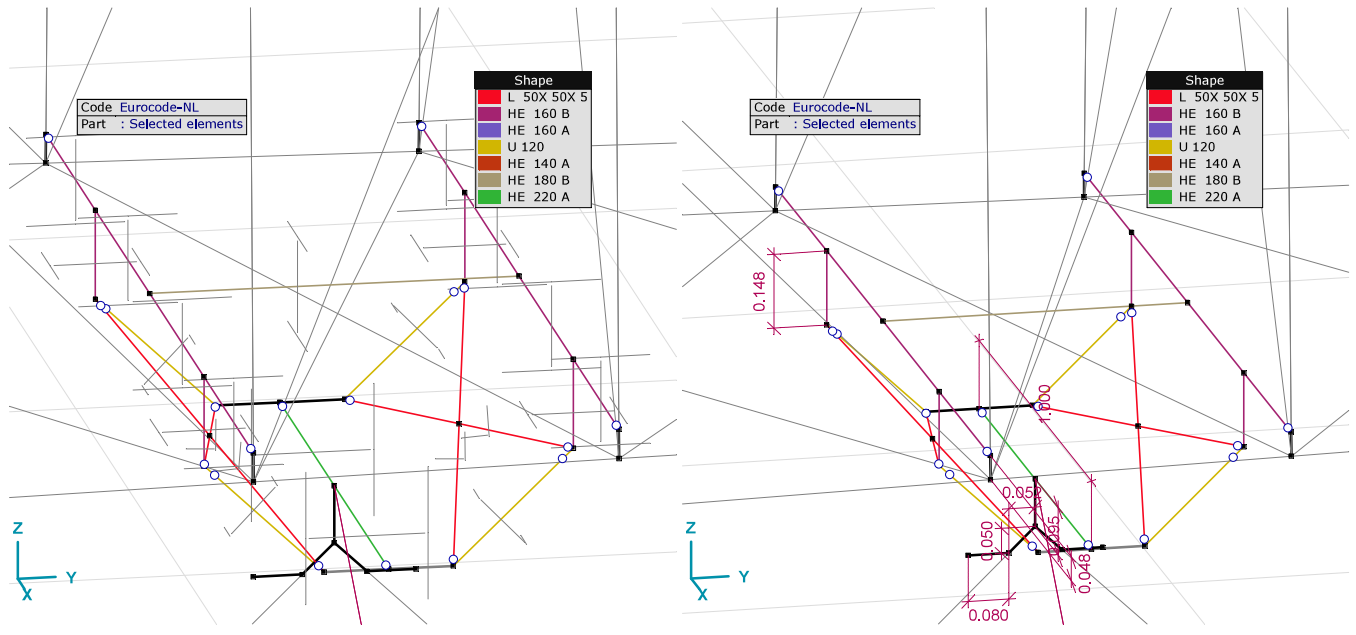

MCA_mid_attachment_(1)_cross-section_orientation_(2)_dimension

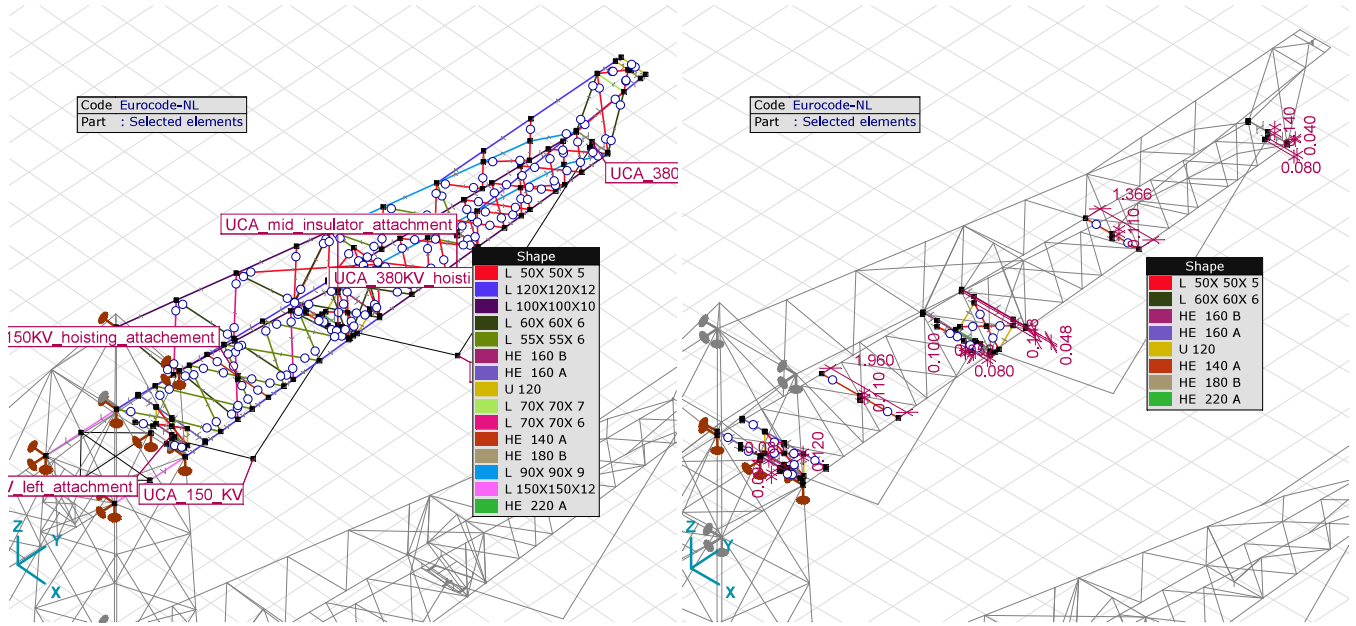

Upper_cross_arms_details

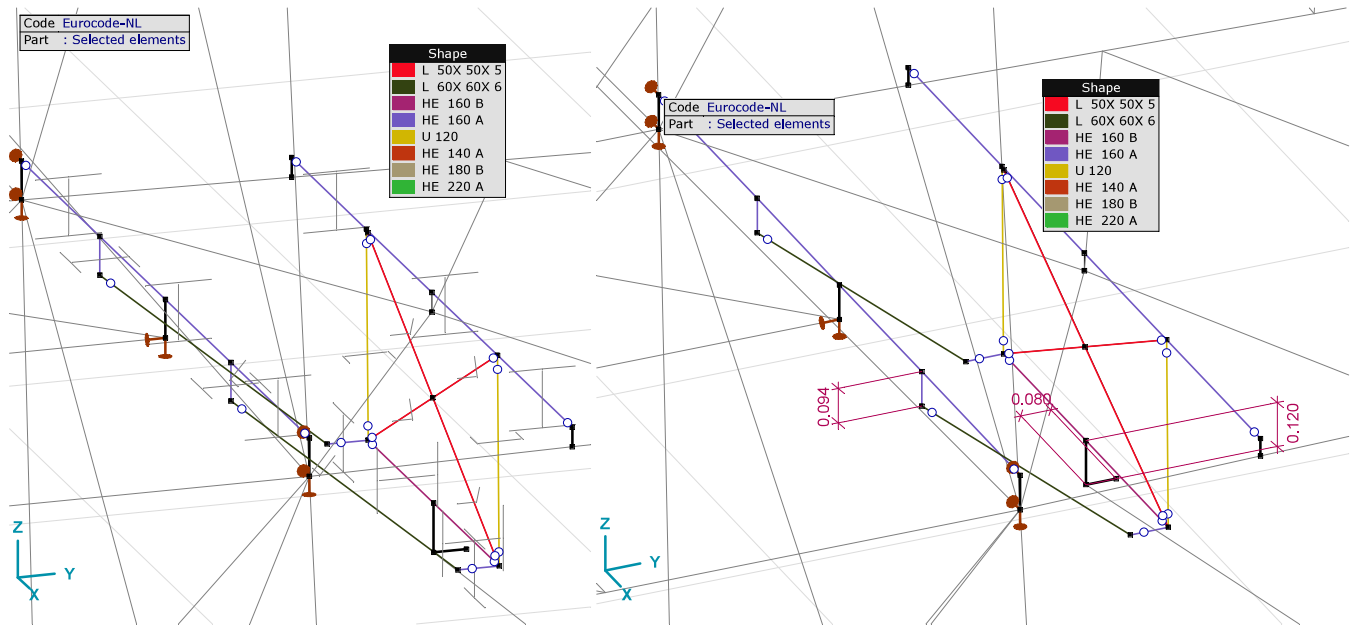

UCA_150_KV_left_attachment_(1)crosssection_shape_(2)dimensions

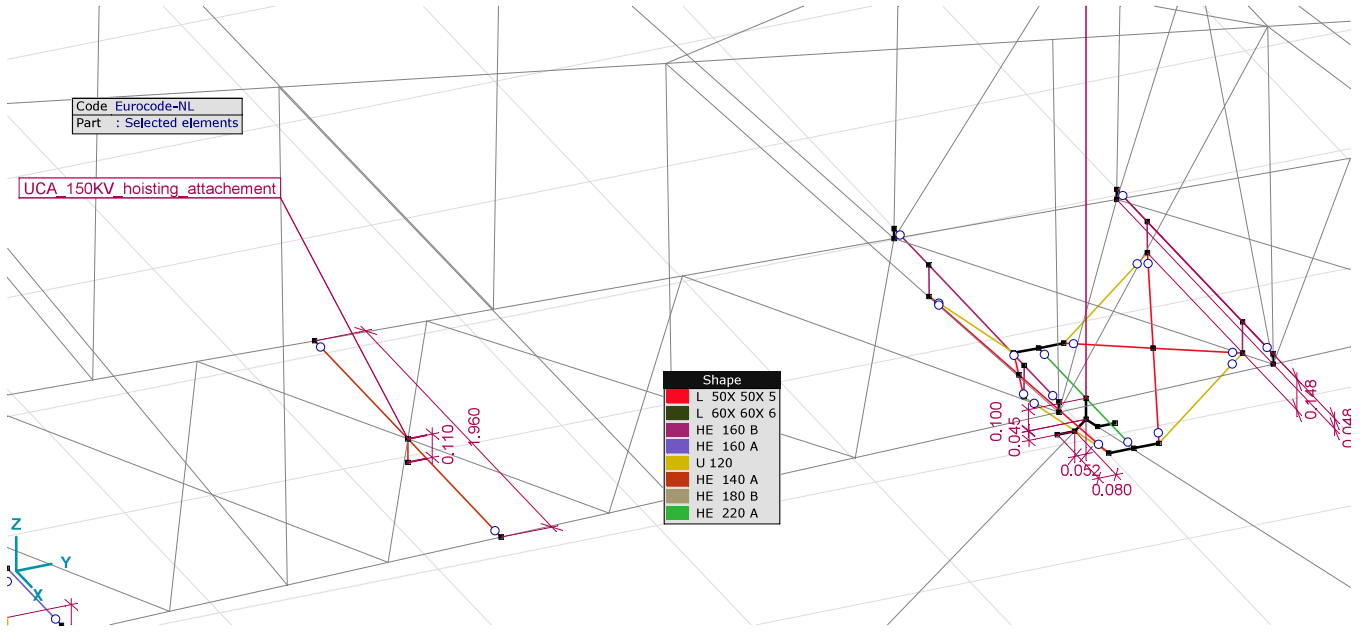

UCA_150KV_hoisting_beam_details

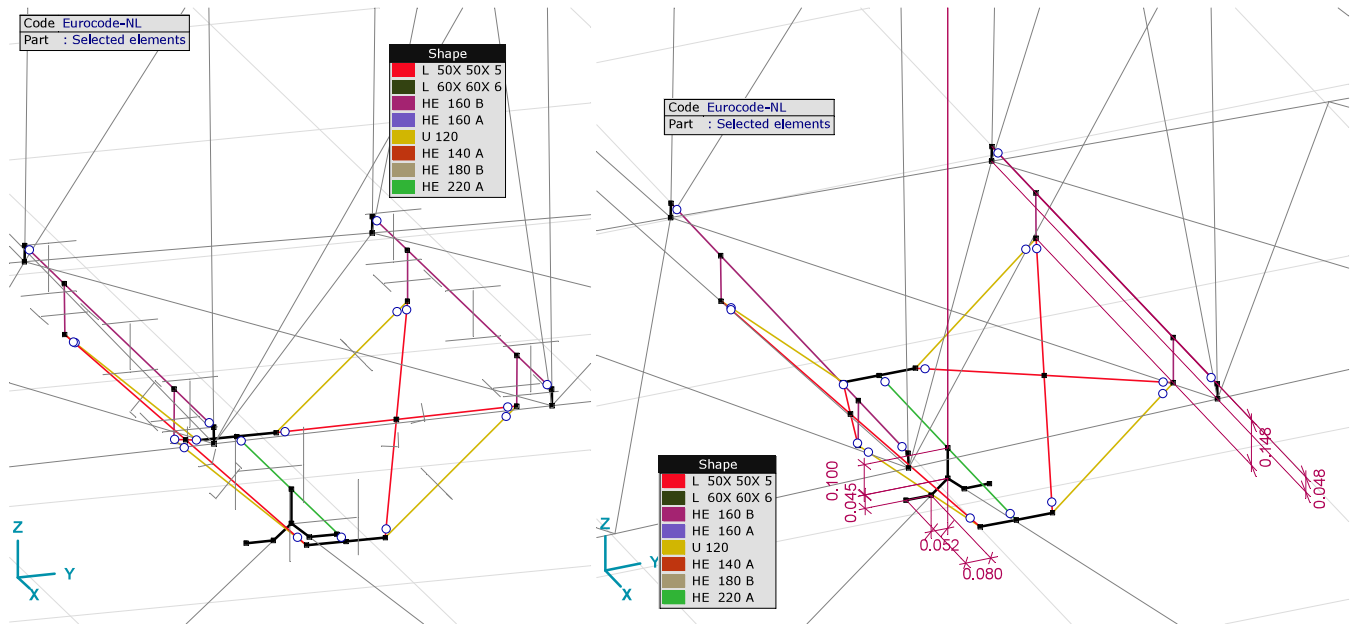

UCA_mid_attachment_(1)crosssection_shape_(2)dimensions

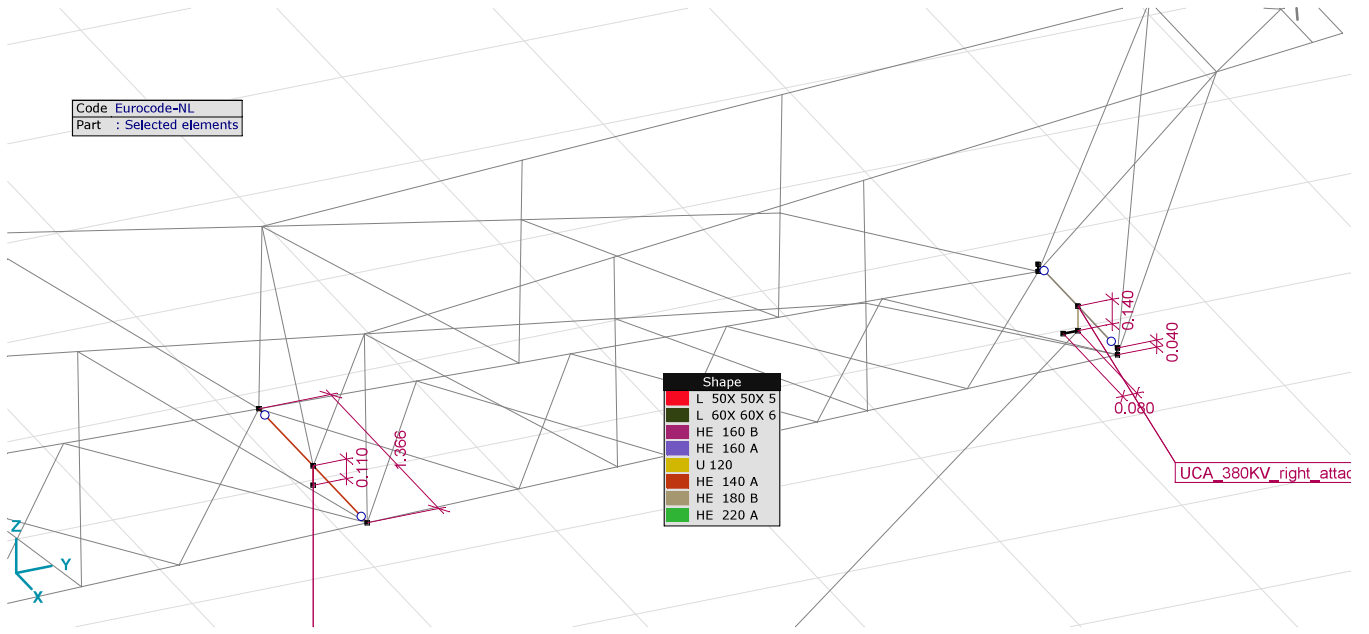

UCA_380KV_right_attachment_details

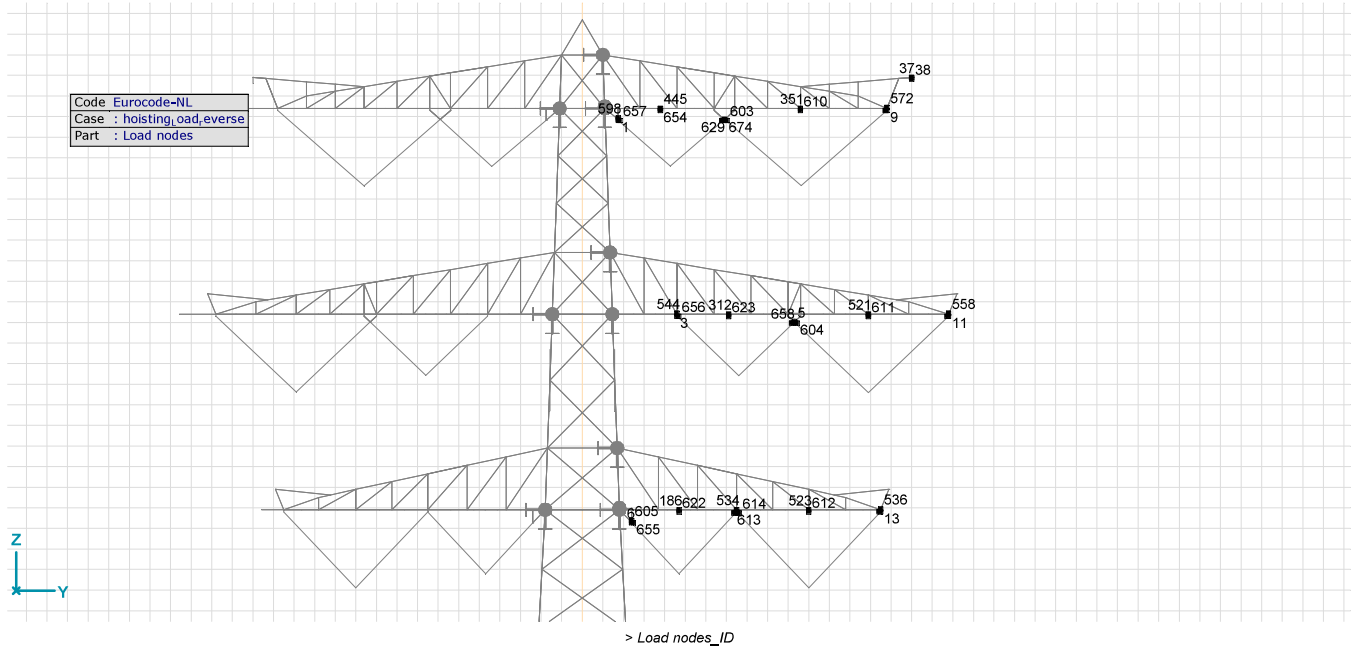

1a_90: Nodal loads [Load nodes]

	Direction ▼	Fx [kN]	Fy [kN]	Fz [kN] ▲	Mx [kNm]	My [kNm]	Mz [kNm]
38	Global	0	-11.91	-7.34	0	0	0
8	R16	38.45			0		
13	R16	76.05			0		
11	R14	79.15			0		
621	R12	40.14			0		
9	R10	82.57			0		
675	R8	41.64			0		

Fx, Fy, Fz: Load force component; Mx, My, Mz: Load moment component;

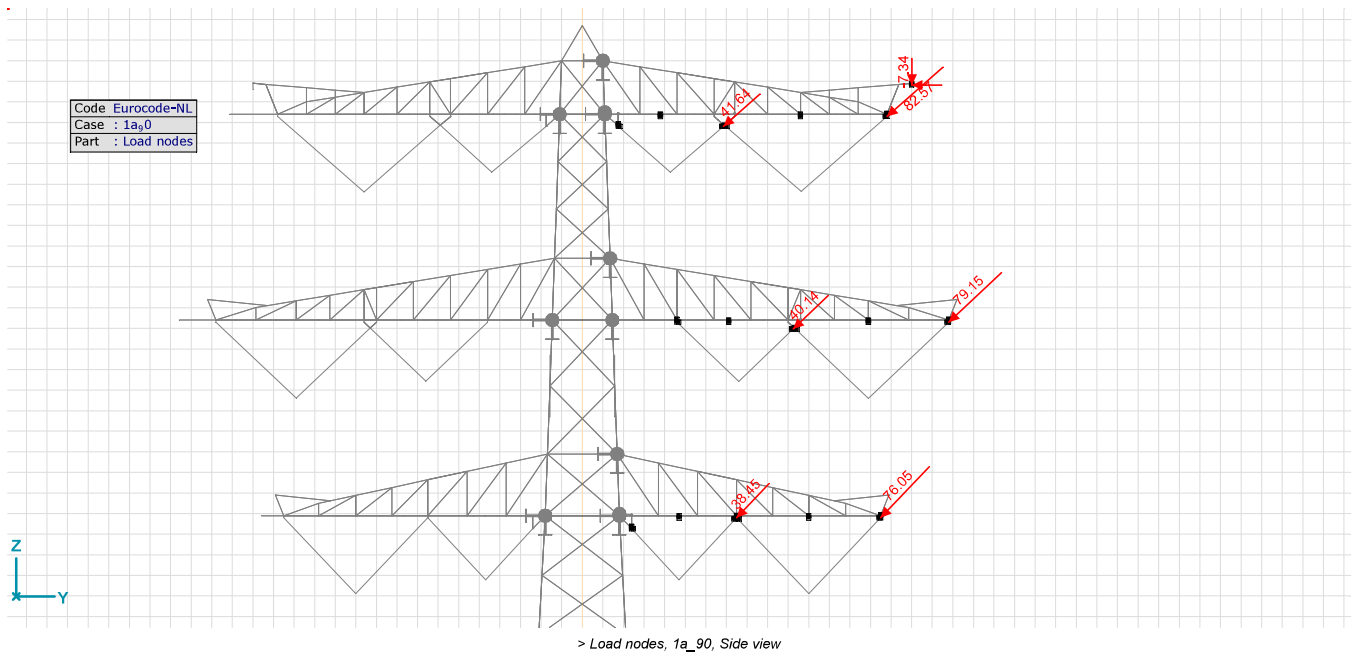

1a_270: Nodal loads [Load nodes]

	Direction ▼	Fx [kN]	Fy [kN]	Fz [kN] ▲	Mx [kNm]	My [kNm]	Mz [kNm]
38	Global	0	11.88	-7.19	0	0	0
670	R17	76.05			0		
6	R15	38.45			0		
620	R13	79.48			0		
3	R11	40.14			0		
674	R9	82.58			0		
1	R7	41.69			0		

Fx, Fy, Fz: Load force component; Mx, My, Mz: Load moment component;

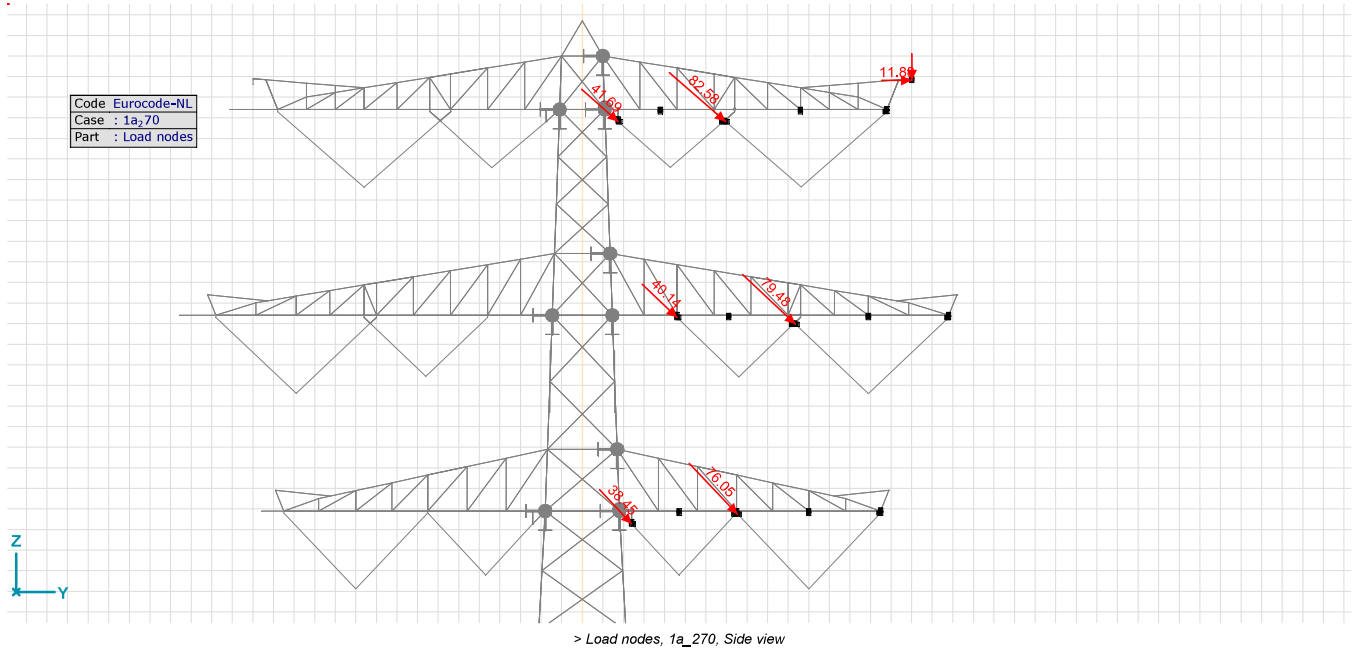

3_90: Nodal loads [Load nodes]

	Direction ▼	Fx [kN]	Fy [kN]	Fz [kN] ▲	Mx [kNm]	My [kNm]	Mz [kNm]		Direction ▼	Fx [kN]	Fy [kN]	Fz [kN] ▲	Mx [kNm]	My [kNm]	Mz [kNm]
38	Global	0	-10.23	-22.95	0	0	0	621	R12	41.18			0		
670	R17	36.99			0			3	R11	19.74			0		
671	R16	39.02			0			9	R10	85.42			0		
13	R16	77.56			0			674	R9	41.04			0		
6	R15	18.43			0			675	R8	43.33			0		
11	R14	81.80			0			1	R7	20.00			0		
620	R13	39.42			0										

Fx, Fy, Fz: Load force component; Mx, My, Mz: Load moment component;

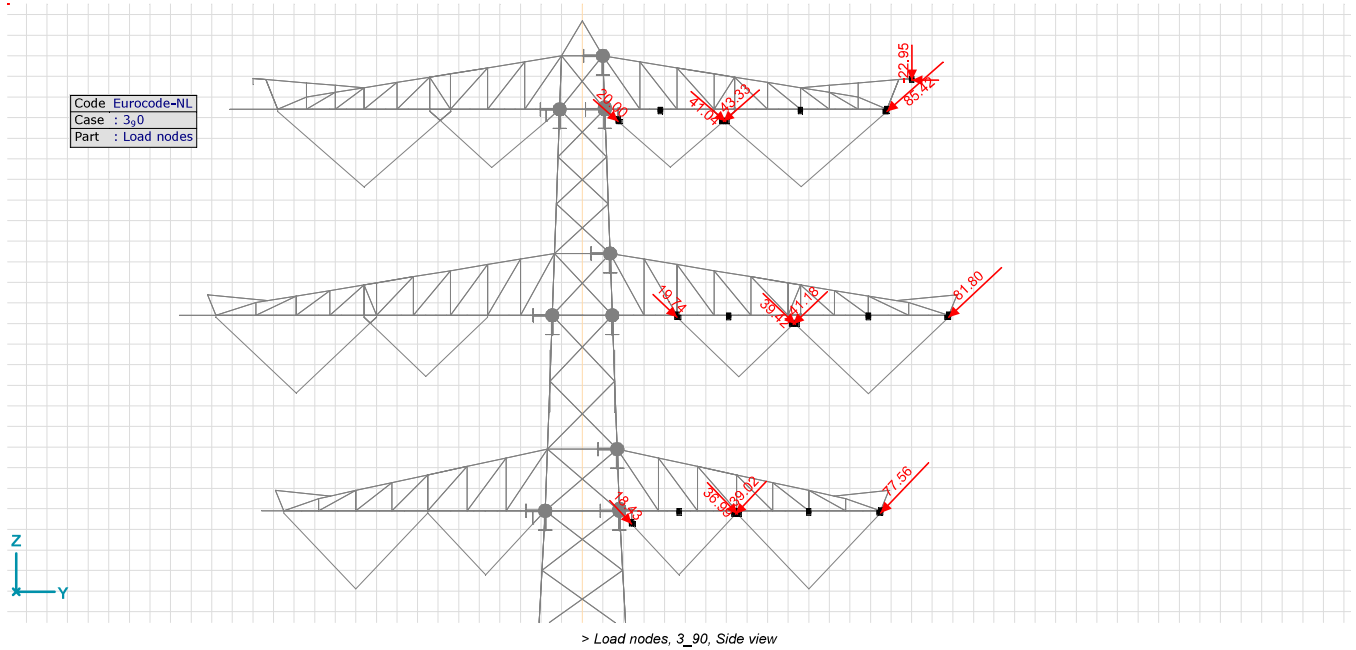

3_270: Nodal loads [Load nodes]

	Direction ▼	Fx [kN]	Fy [kN]	Fz [kN] ▲	Mx [kNm]	My [kNm]	Mz [kNm]		Direction ▼	Fx [kN]	Fy [kN]	Fz [kN] ▲	Mx [kNm]	My [kNm]	Mz [kNm]
38	Global	0	10.22	-22.75	0	0	0	621	R12	19.74			0		
670	R17	77.56			0			3	R11	41.17			0		
671	R16	18.39			0			9	R10	41.01			0		
13	R16	36.99			0			674	R9	85.45			0		
6	R15	39.41			0			675	R8	20.73			0		
11	R14	39.40			0			1	R7	43.06			0		
620	R13	81.81			0										

Fx, Fy, Fz: Load force component; Mx, My, Mz: Load moment component;

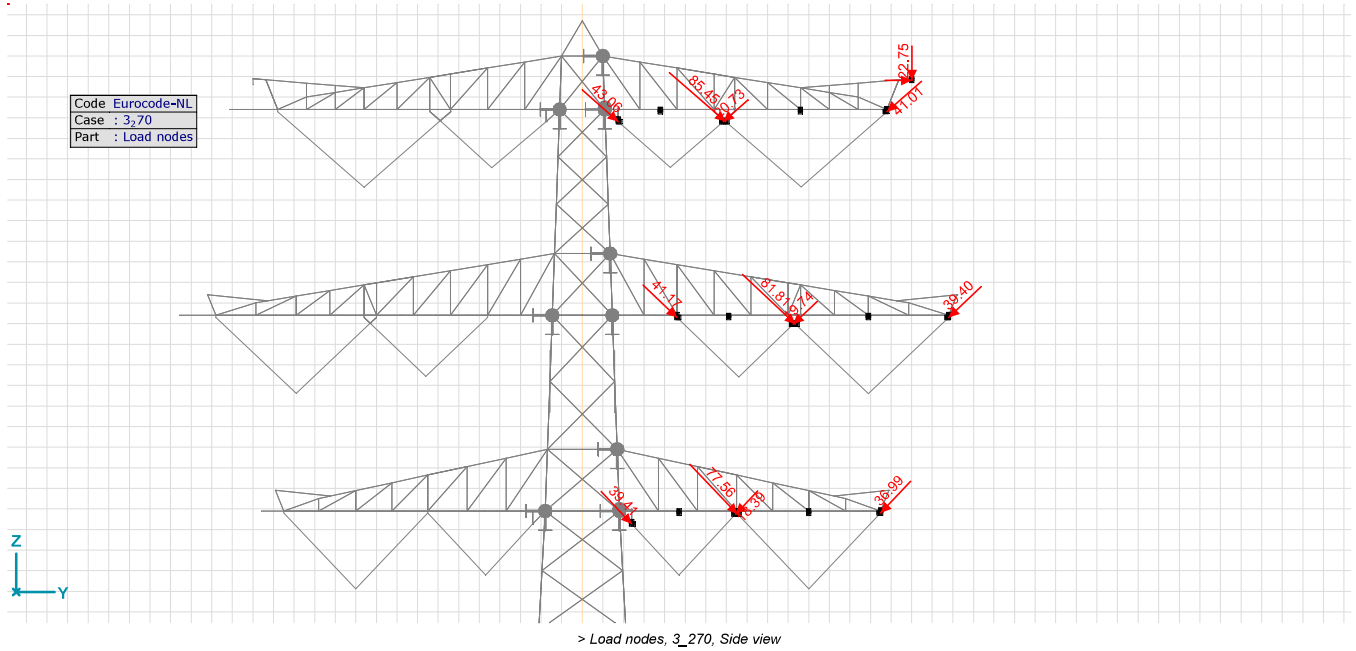

5a_01: Nodal loads [Load nodes]

	Direction ▼	Fx [kN]	Fy [kN]	Fz [kN] ▲	Mx [kNm]	My [kNm]	Mz [kNm]
37	Global	17.21	0	-3.53	0	0	0
9	R10	33.63					
674	R9	33.64					
675	R8	17.74					
1	R7	17.19					

Fx, Fy, Fz: Load force component; Mx, My, Mz: Load moment component;

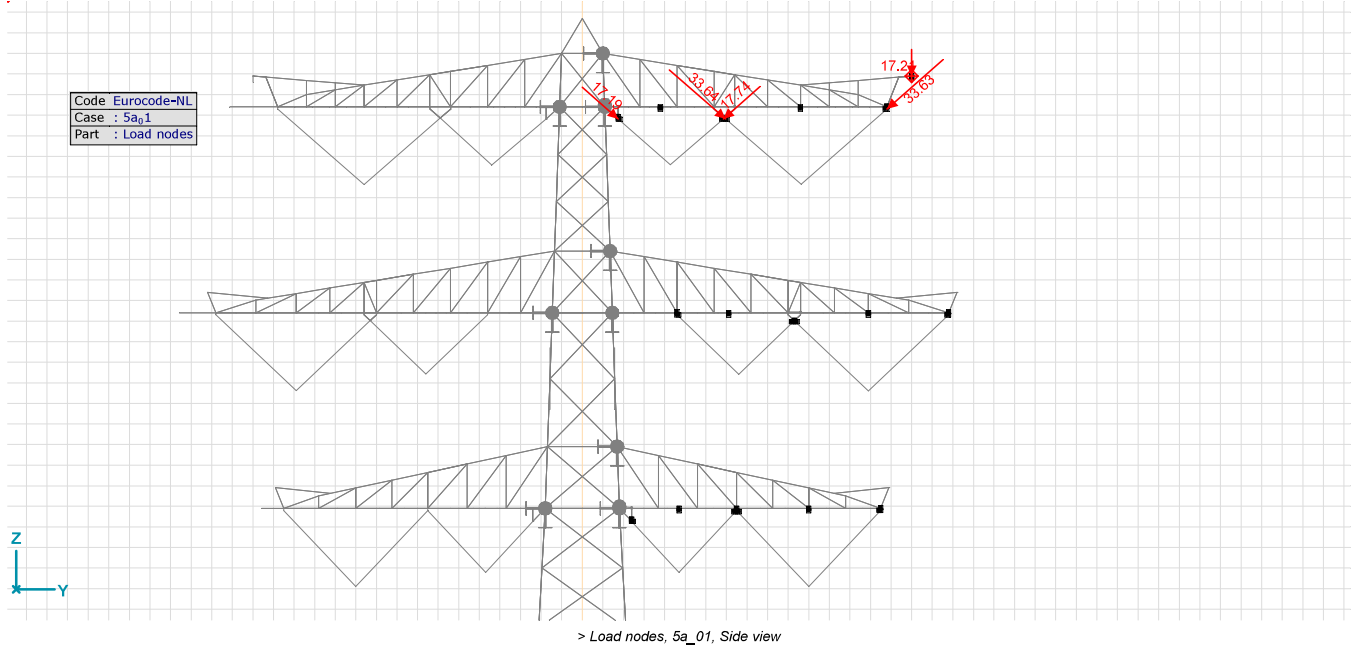

5a_10: Nodal loads [Load nodes]

	Direction ▼	Fx [kN]	Fy [kN]	Fz [kN] ▲	Mx [kNm]	My [kNm]	Mz [kNm]
617	Global	52.54	-49.85	-12.00	0	0	0
614	Global	52.54	49.85	-12.00	0	0	0
671	R16	15.82					
6	R15	15.84					

Fx, Fy, Fz: Load force component; Mx, My, Mz: Load moment component;

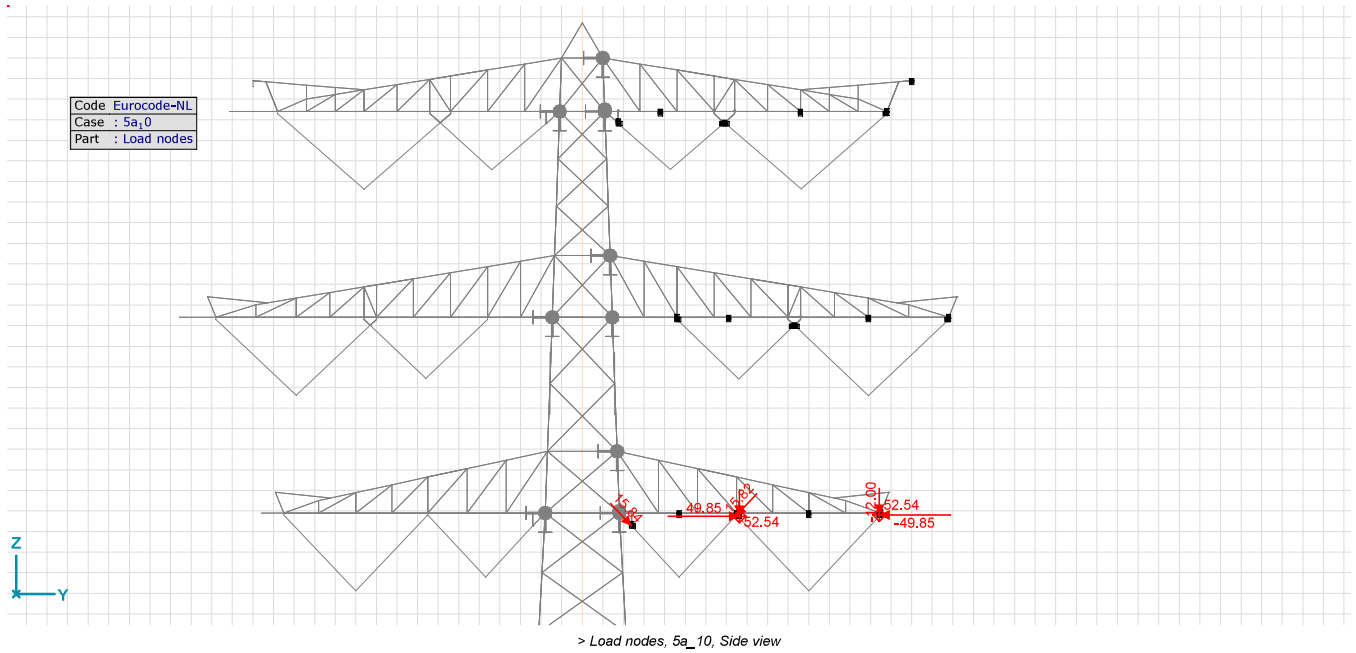

5a_11: Nodal loads [Load nodes]

	Direction ▼	Fx [kN]	Fy [kN]	Fz [kN] ▲	Mx [kNm]	My [kNm]	Mz [kNm]
604	Global	52.54	55.55	-12.00	0	0	0
615	Global	52.54	-55.60	-12.00	0	0	0
621	R12	17.74			0		
3	R11	16.73			0		

Fx, Fy, Fz: Load force component; Mx, My, Mz: Load moment component;

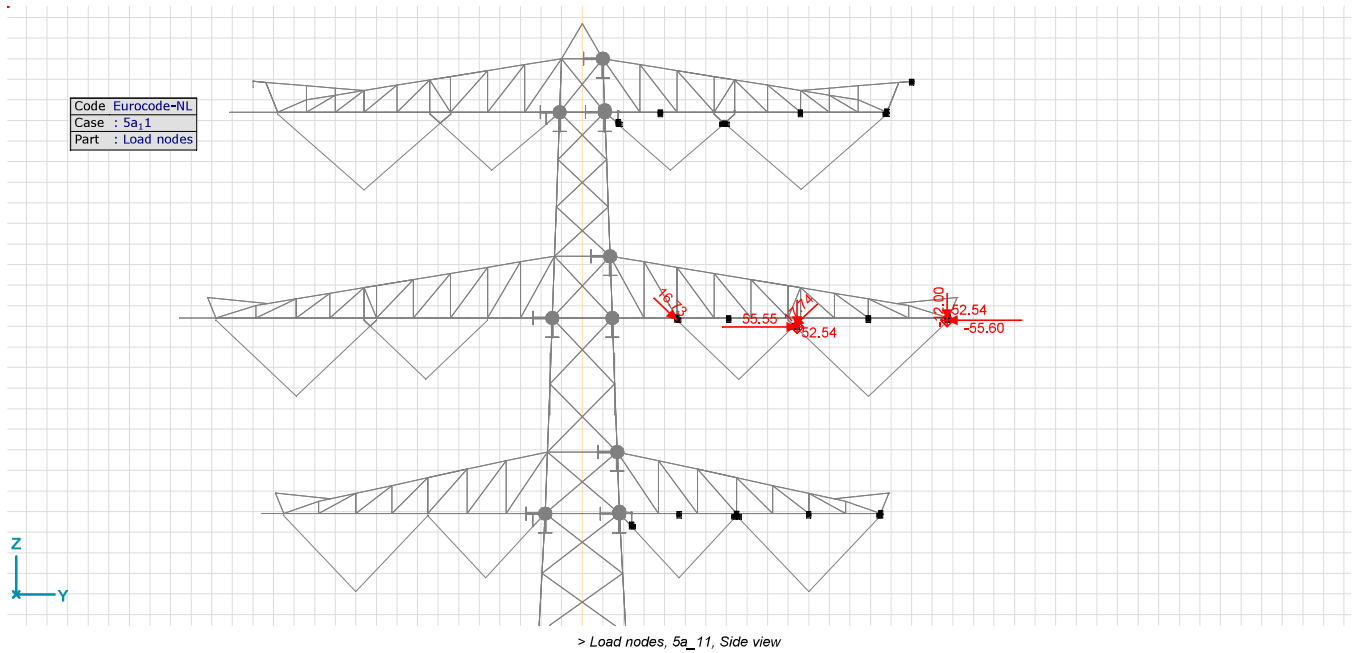

5a_12: Nodal loads [Load nodes]

	Direction ▼	Fx [kN]	Fy [kN]	Fz [kN] ▲	Mx [kNm]	My [kNm]	Mz [kNm]
603	Global	52.54	60.01	-12.00	0	0	0
616	Global	52.54	-60.01	-12.00	0	0	0
675	R8	17.74			0		
1	R7	17.19			0		

Fx, Fy, Fz: Load force component; Mx, My, Mz: Load moment component;

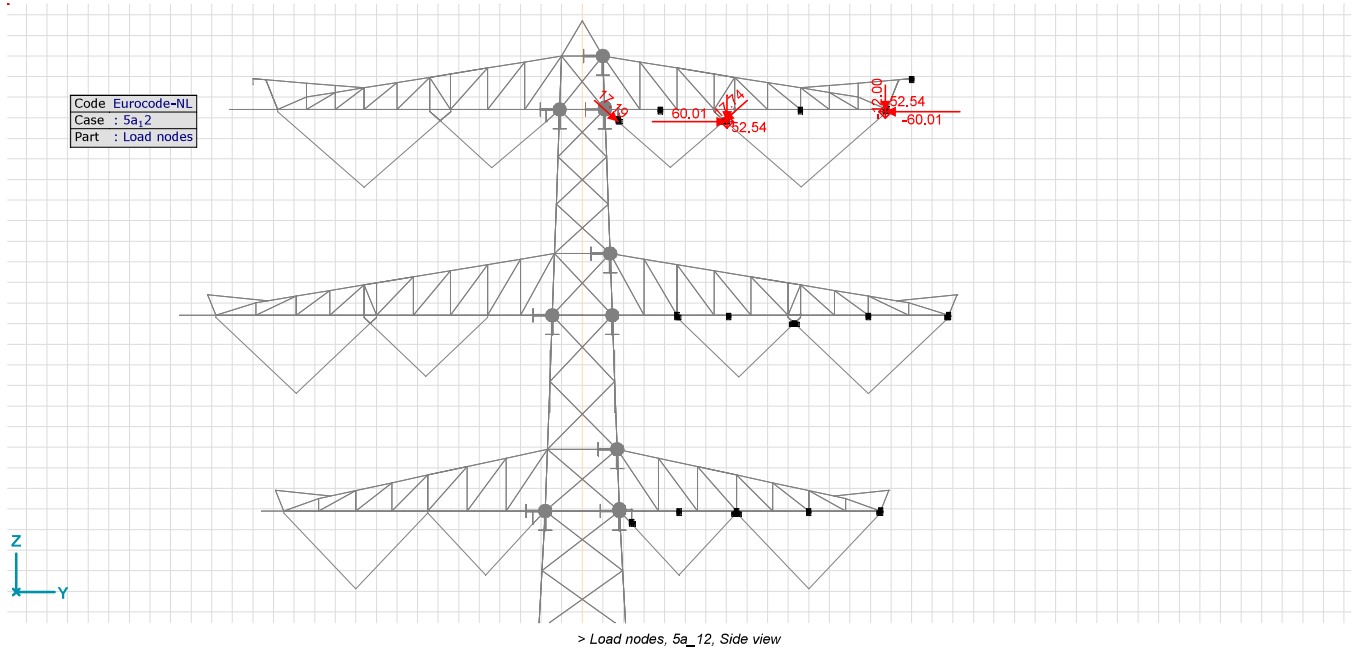

5a_30: Nodal loads [Load nodes]

	Direction ▼	Fx [kN]	Fy [kN]	Fz [kN] ▲	Mx [kNm]	My [kNm]	Mz [kNm]
655	Global	26.27	24.41	-6.40	0	0	0
613	Global	26.27	-24.41	-6.40	0	0	0
670	R17	30.64			0		
13	R16	30.64			0		

Fx, Fy, Fz: Load force component; Mx, My, Mz: Load moment component.

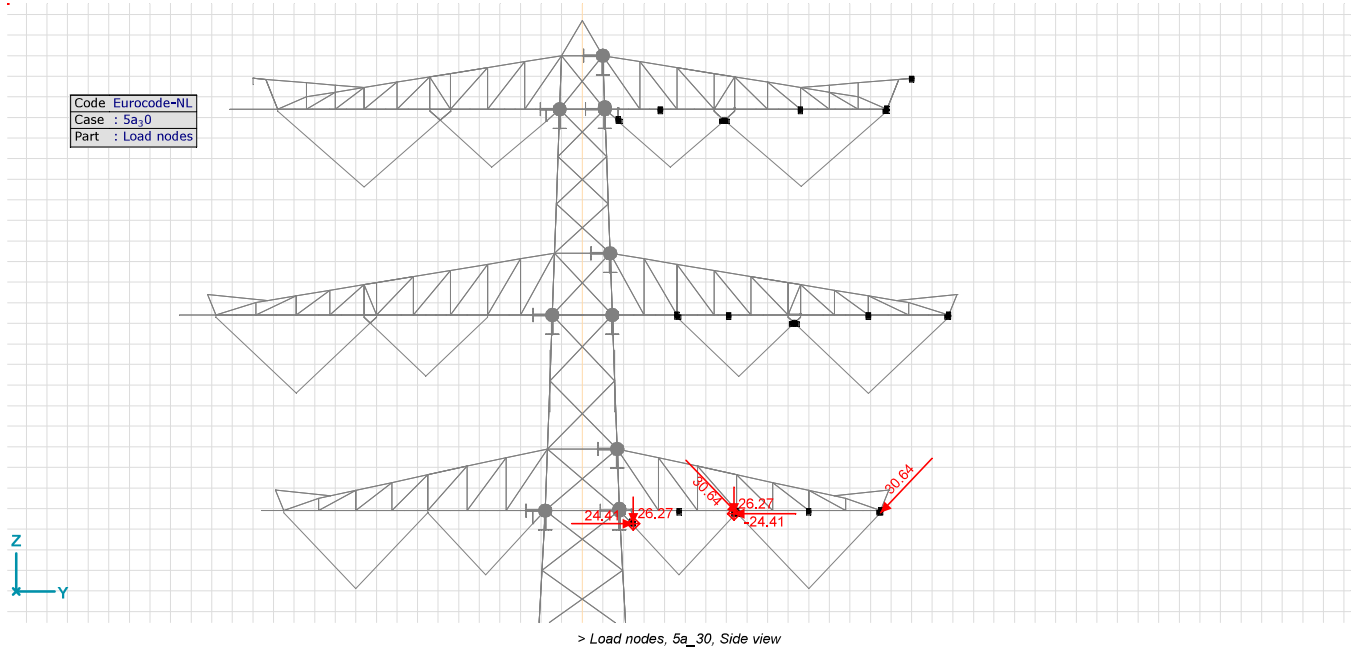

5a_31: Nodal loads [Load nodes]

	Direction ▼	Fx [kN]	Fy [kN]	Fz [kN] ▲	Mx [kNm]	My [kNm]	Mz [kNm]
656	Global	26.27	27.49	-6.40	0	0	0
658	Global	26.27	-27.49	-6.40	0	0	0
11	R14	32.32			0		
620	R13	32.33			0		

Fx, Fy, Fz: Load force component; Mx, My, Mz: Load moment component.

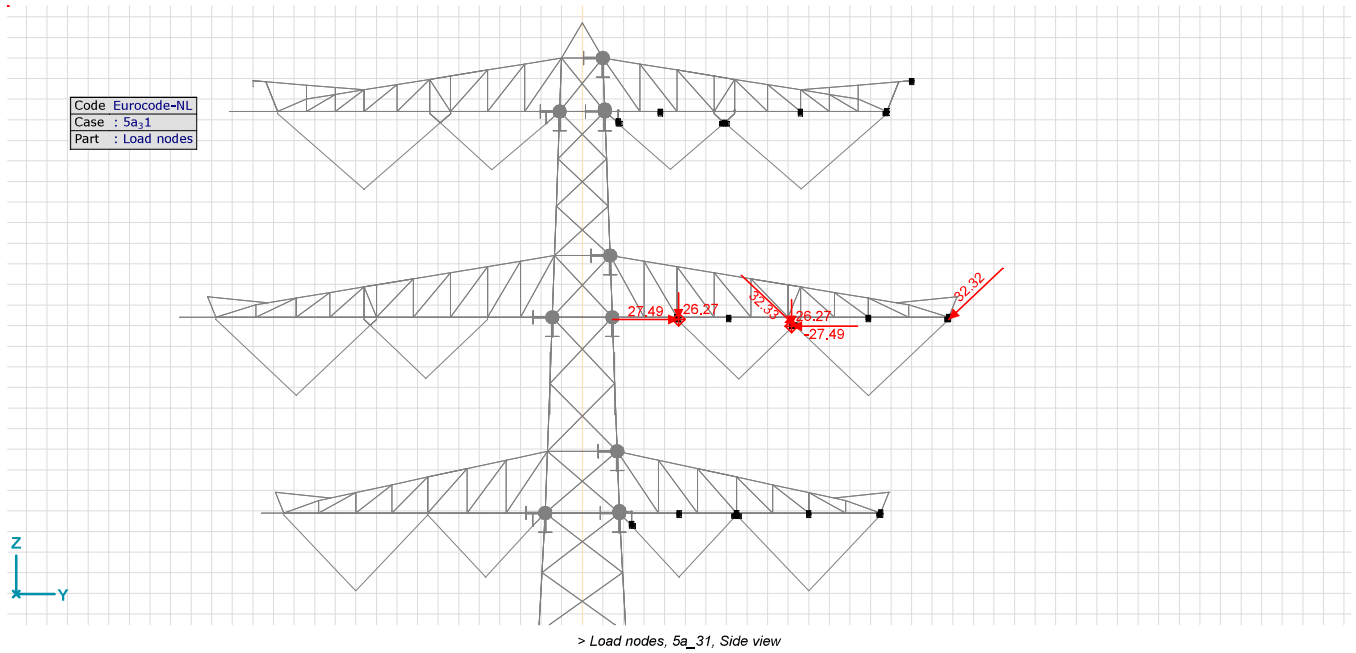

5a_32: Nodal loads [Load nodes]

	Direction ▼	Fx [kN]	Fy [kN]	Fz [kN] ▲	Mx [kNm]	My [kNm]	Mz [kNm]
657	Global	26.27	29.79	-6.40	0	0	0
629	Global	26.27	-29.79	-6.40	0	0	0
9	R10	33.63			0		
674	R9	33.64			0		

Fx, Fy, Fz: Load force component; Mx, My, Mz: Load moment component;

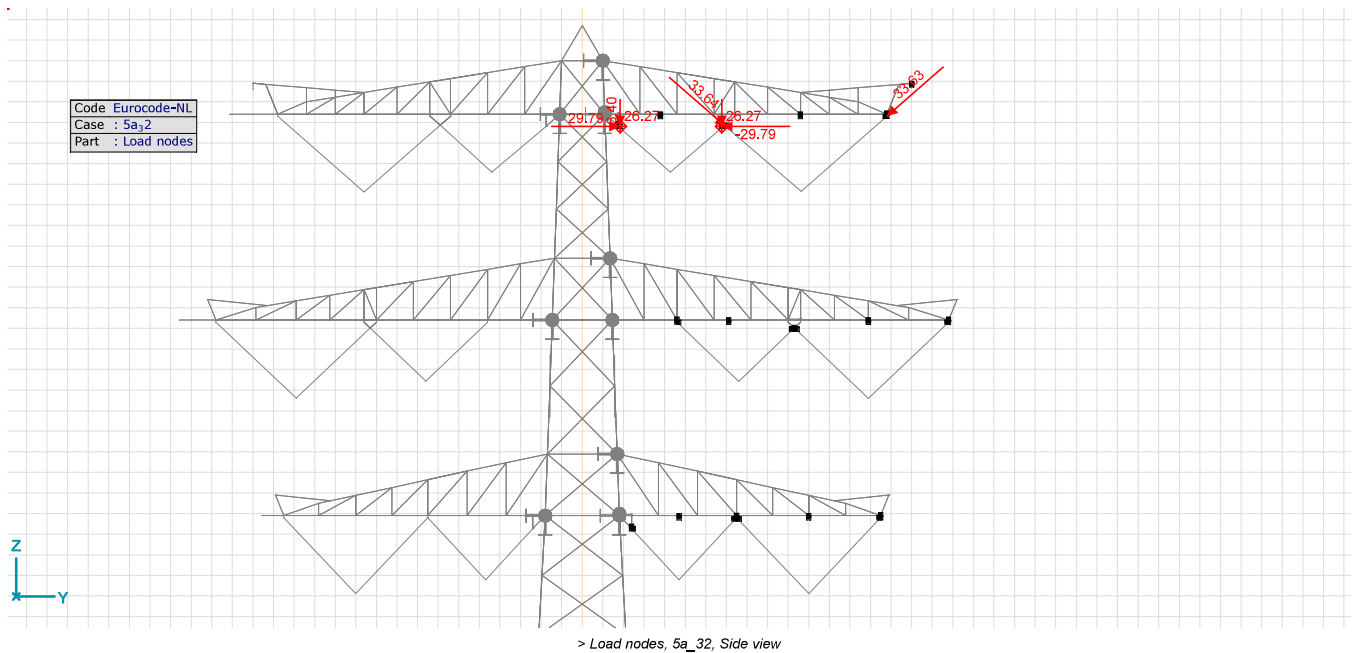

hoisting_Load: Nodal loads [Load nodes]

	Direction ▼	Fx [kN]	Fy [kN]	Fz [kN] ▲	Mx [kNm]	My [kNm]	Mz [kNm]
611	Global	0	-10.12	-61.93	0	0	0
610	Global	0	-8.51	-61.83	0	0	0
612	Global	0	-11.26	-61.81	0	0	0
623	Global	0	-5.18	-32.23	0	0	0
654	Global	0	-5.93	-32.16	0	0	0
622	Global	0	-5.18	-32.16	0	0	0

Fx, Fy, Fz: Load force component; Mx, My, Mz: Load moment component;

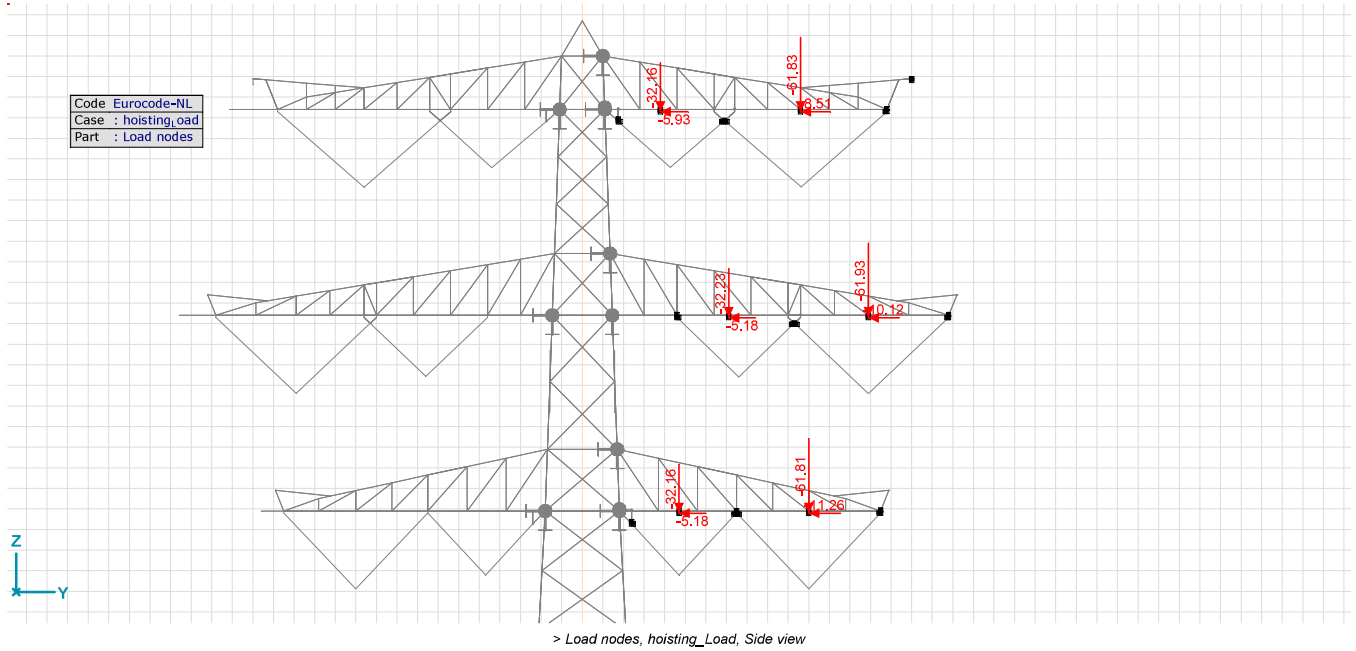

hoisting_Load_reverse: Nodal loads [Load nodes]

	Direction ▼	Fx [kN]	Fy [kN]	Fz [kN] ▲	Mx [kNm]	My [kNm]	Mz [kNm]
611	Global	0	10.12	-61.93	0	0	0
610	Global	0	8.51	-61.83	0	0	0
612	Global	0	11.26	-61.81	0	0	0
623	Global	0	5.93	-32.23	0	0	0
654	Global	0	5.58	-32.16	0	0	0
622	Global	0	5.18	-32.16	0	0	0

Fx, Fy, Fz: Load force component; Mx, My, Mz: Load moment component;

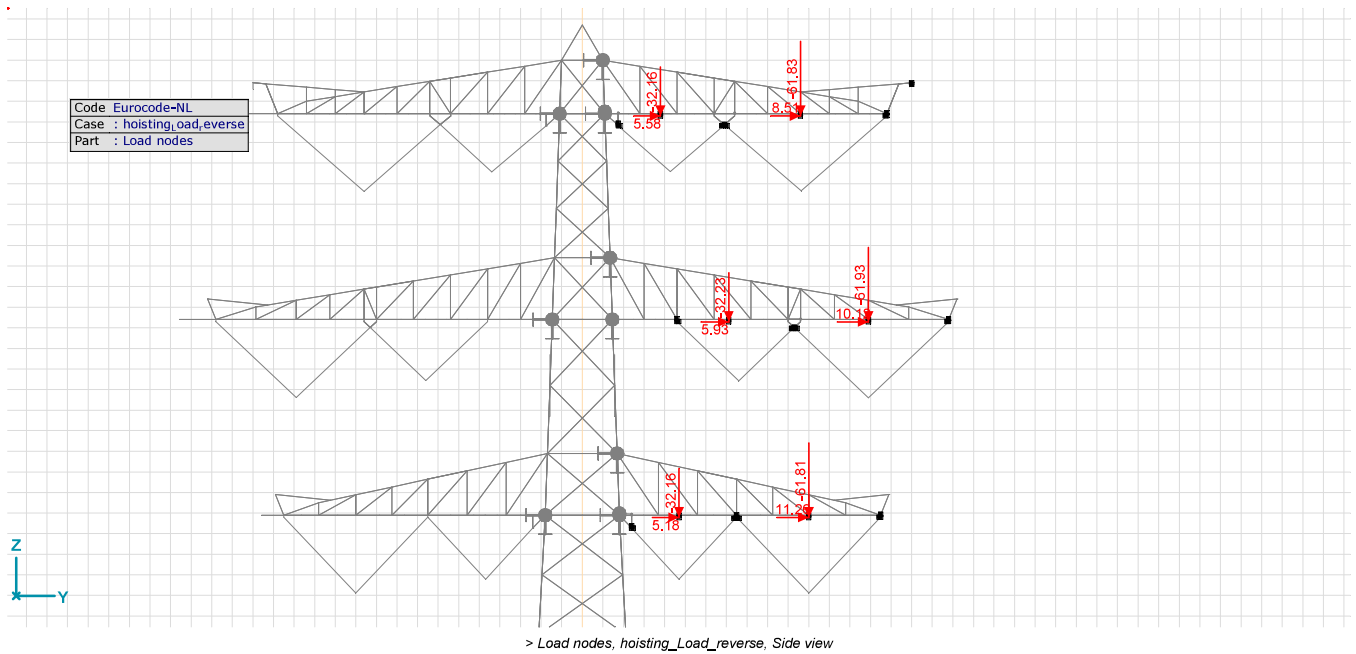

144_SLS_1a_90_1: Nodal loads [Load nodes]

	Direction ▼	Fx [kN]	Fy [kN]	Fz [kN] ▲	Mx [kNm]	My [kNm]	Mz [kNm]
674	Global	0	-39.41	-45.16	0	0	0
620	Global	0	-37.09	-44.84	0	0	0
670	Global	0	-38.38	-44.46	0	0	0
671	R16	28.81			0		
621	R12	30.07			0		
675	R8	31.26			0		

Fx, Fy, Fz: Load force component; Mx, My, Mz: Load moment component;

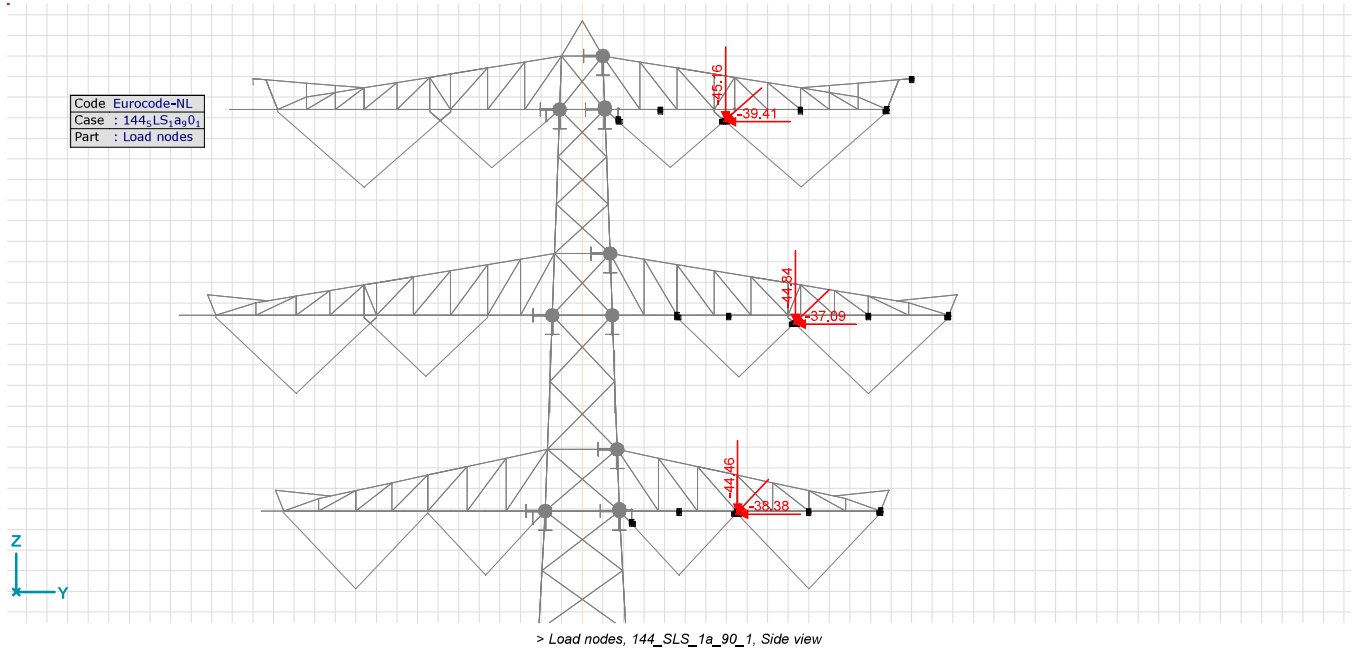

144_SLS_1a_270_1: Nodal loads [Load nodes]

	Direction ▼	Fx [kN]	Fy [kN]	Fz [kN] ▲	Mx [kNm]	My [kNm]	Mz [kNm]
674	Global	0	39.41	-45.16	0	0	0
620	Global	0	37.09	-44.84	0	0	0
670	Global	0	34.83	-44.46	0	0	0
6	R15	28.81			0		
3	R11	30.07			0		
1	R7	31.25			0		

Fx, Fy, Fz: Load force component; Mx, My, Mz: Load moment component;

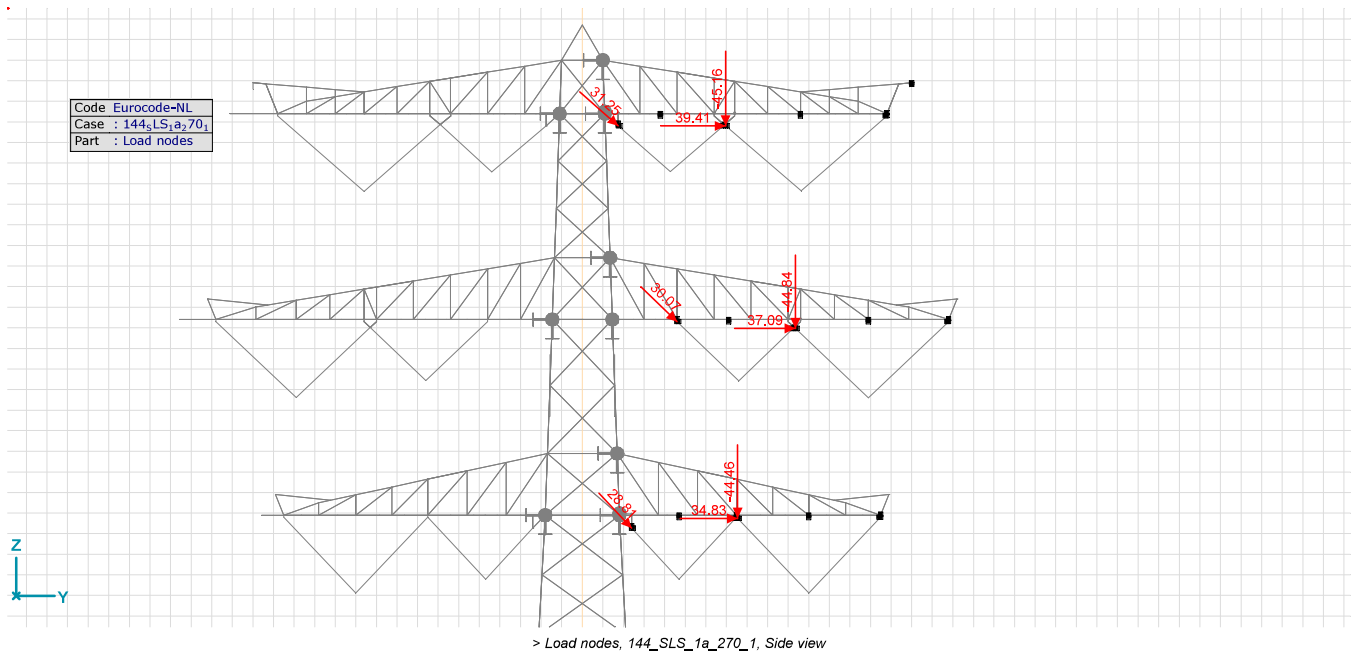

145_SLS_3_90: Nodal loads [Load nodes]

	Direction ▼	Fx [kN]	Fy [kN]	Fz [kN] ▲	Mx [kNm]	My [kNm]	Mz [kNm]
674	Global	0	-22.27	-63.36	0	0	0
620	Global	0	-20.06	-63.29	0	0	0
670	Global	0	-18.62	-63.09	0	0	0
8	R16	29.36			0		
6	R15	15.63			0		
621	R12	30.98			0		
3	R11	16.69			0		
675	R8	32.63			0		
1	R7	16.96			0		

Fx, Fy, Fz: Load force component; Mx, My, Mz: Load moment component;

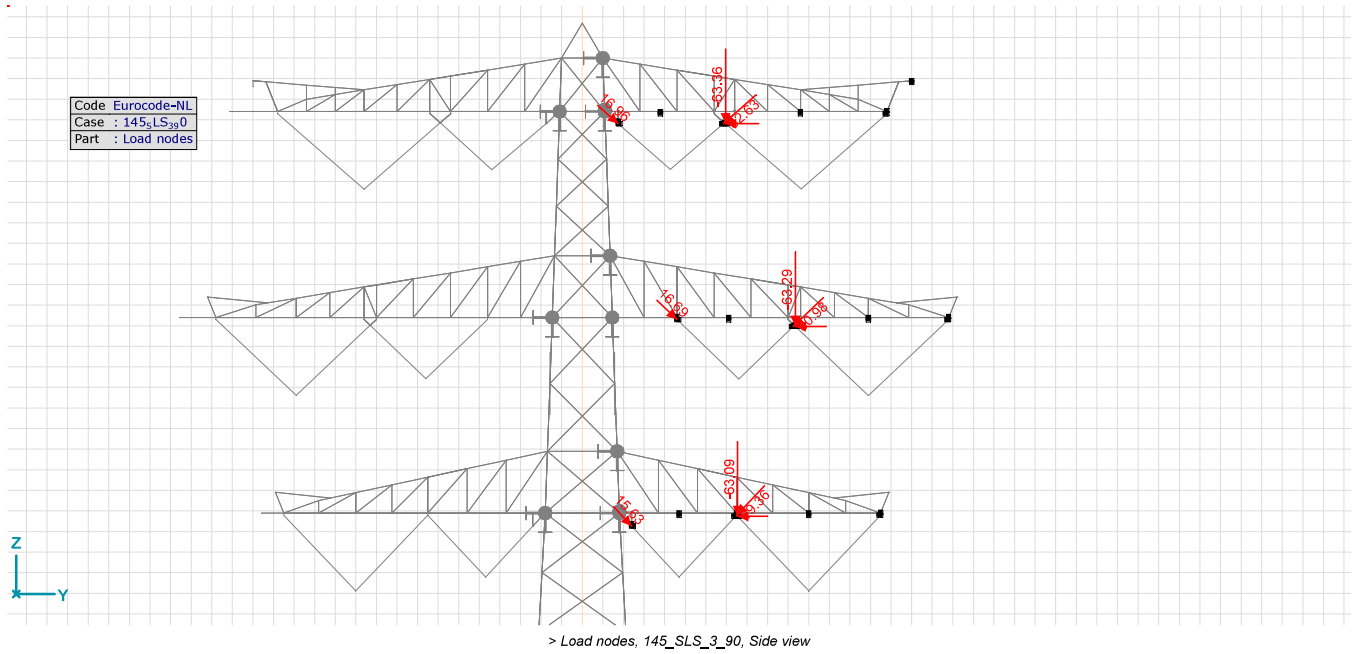

145_SLS_3_270: Nodal loads [Load nodes]

	Direction ▼	Fx [kN]	Fy [kN]	Fz [kN] ▲	Mx [kNm]	My [kNm]	Mz [kNm]
674	Global	0	22.27	-63.36	0	0	0
620	Global	0	20.06	-63.29	0	0	0
670	Global	0	18.62	-63.09	0	0	0
671	R16	15.60			0		
6	R15	29.36			0		
621	R12	16.69			0		
3	R11	30.10			0		
675	R8	17.50			0		
1	R7	32.39			0		

Fx, Fy, Fz: Load force component; Mx, My, Mz: Load moment component;

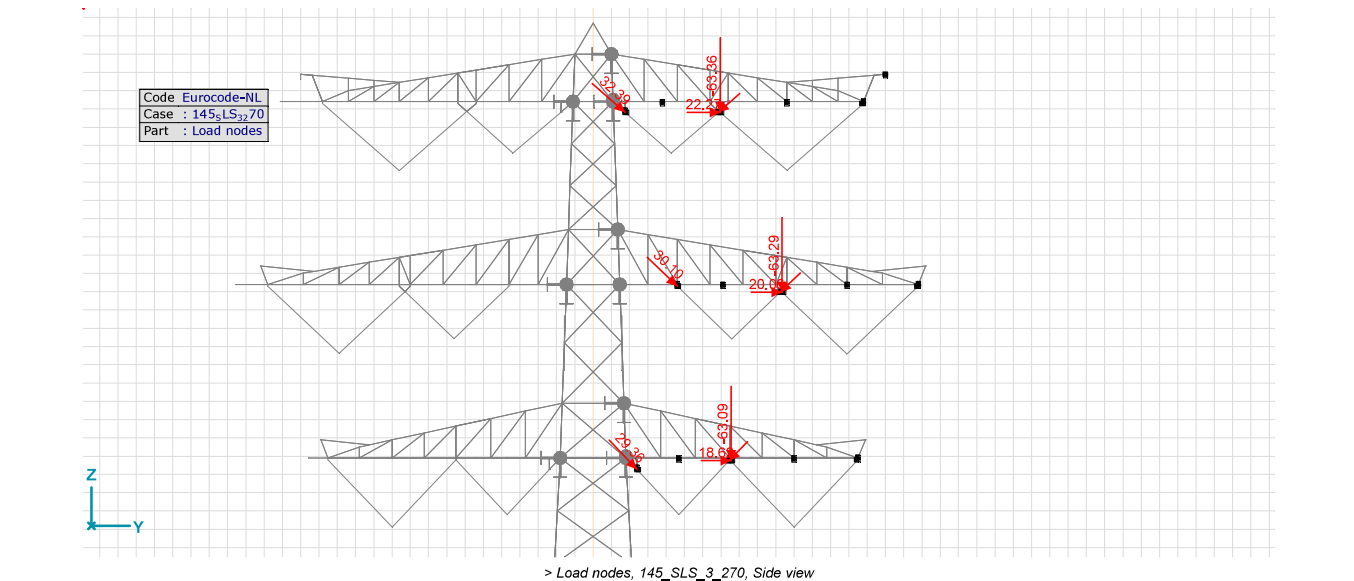

Project

Analysis by

Model: S+0_combi.axs

2/22/2021

Page 24

Custom load combinations by load cases

	Name	Type	144_SLS_1a_90_1	144_SLS_1a_270_1	145_SLS_3_90	145_SLS_3_270	1a_90	1a_270	3_90	3_270	5a_01	5a_10	5a_11	5a_12	5a_30
1	Co #1	ULS	1.00	0	0	0	0	0	0	0	0	0	0	0	0
2	Co #2	ULS	0	1.00	0	0	0	0	0	0	0	0	0	0	0
3	Co #3	ULS	0	0	1.00	0	0	0	0	0	0	0	0	0	0
4	Co #4	ULS	0	0	0	1.00	0	0	0	0	0	0	0	0	0
5	Co #5	ULS	0	0	0	0	1.00	0	0	0	0	0	0	0	0
6	Co #6	ULS	0	0	0	0	0	1.00	0	0	0	0	0	0	0
7	Co #7	ULS	0	0	0	0	0	0	1.00	0	0	0	0	0	0
8	Co #8	ULS	0	0	0	0	0	0	0	1.00	0	0	0	0	0
9	Co #9	ULS	0	0	0	0	0	0	0	0	1.00	0	0	0	0
10	Co #10	ULS	0	0	0	0	0	0	0	0	0	1.00	0	0	0
11	Co #11	ULS	0	0	0	0	0	0	0	0	0	0	1.00	0	0
12	Co #12	ULS	0	0	0	0	0	0	0	0	0	0	0	1.00	0
13	Co #13	ULS	0	0	0	0	0	0	0	0	0	0	0	0	1.00
14	Co #14	ULS	0	0	0	0	0	0	0	0	0	0	0	0	0
15	Co #15	ULS	0	0	0	0	0	0	0	0	0	0	0	0	0
16	Co #16	ULS	0	0	0	0	0	0	0	0	0	0	0	0	0
17	Co #17	ULS	0	0	0	0	0	0	0	0	0	0	0	0	0
18	Co #18	ULS	0	0	0	0	0	0	0	0	0	0	0	0	0

	5a_31	5a_32	hoisting_Load	hoisting_Load_reverse	EG	Comment
1	0	0	0	0	1.00	
2	0	0	0	0	1.00	
3	0	0	0	0	1.00	
4	0	0	0	0	1.00	
5	0	0	0	0	1.00	
6	0	0	0	0	1.00	
7	0	0	0	0	1.00	
8	0	0	0	0	1.00	
9	0	0	0	0	1.00	
10	0	0	0	0	1.00	
11	0	0	0	0	1.00	
12	0	0	0	0	1.00	
13	0	0	0	0	1.00	
14	1.00	0	0	0	1.00	
15	0	1.00	0	0	1.00	
16	0	0	1.00	0	1.00	
17	0	0	0	1.00	1.00	
18	0	0	0	0	1.00	

Name: Load combination name; Type: Load combination type; 144_sLS_{1a}0₁, 144_sLS_{1a}270₁, 145_sLS₃0, 145_sLS₃270, 1a₀, 1a₂₇₀, 3₀, 3₂₇₀, 5a₀1, 5a₀, 5a₁, 5a₂, 5a₀, 5a₁, 5a₂, hoisting_oad, hoisting_oad,everse, EG: Factor;

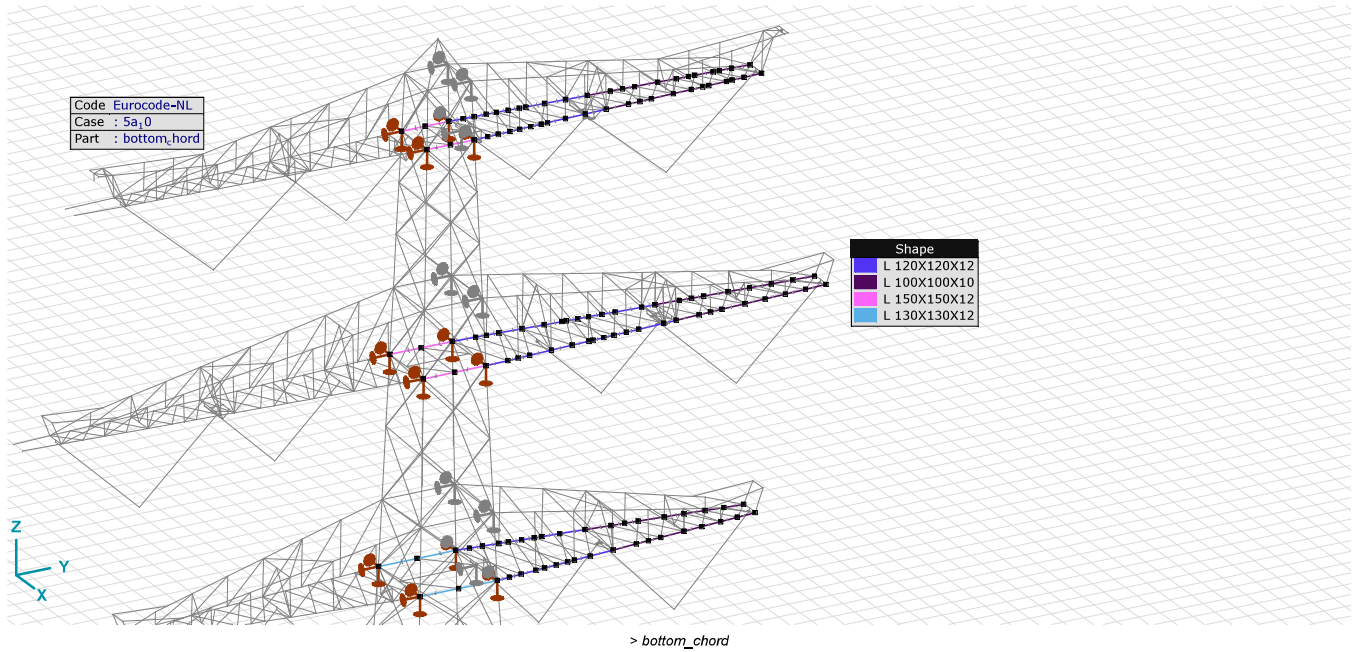

> bottom_chord

Nodal displacements [Linear, Envelope (Default), LCA]

	C	min. max.	Case	eX [mm]	eY [mm]	eZ [mm]	eR [mm]	fX [rad]	fY [rad]	fZ [rad]	fR [rad]
Ext.											
293	eX	min	Co #13	-1.3	-0.2	-0.9	1.5	-0.00016	0	0.00023	0.00028
212		max	Co #10	31.1	-0.8	-6.0	31.6	0.05066	0.61948	0.00008	0.62155
212	eY	min	Co #7	0.2	-5.6	-50.9	51.2	-0.01444	-0.00380	0.00106	0.01497
215		min	Co #7	-0.1	-5.6	-50.9	51.2	-0.01444	0.00382	-0.00106	0.01497
188		max	Co #10	6.7	1.1	0.2	6.8	0.01395	0.13795	-0.00234	0.13867
531		max	Co #10	5.5	1.1	0.3	5.6	0.01164	0.11506	-0.00206	0.11566
212	eZ	min	Co #7	0.2	-5.6	-50.9	51.2	-0.01444	-0.00380	0.00106	0.01497
215		min	Co #7	-0.1	-5.6	-50.9	51.2	-0.01444	0.00382	-0.00106	0.01497
292		max	Co #10	-1.0	-0.9	0.7	1.5	0.00013	0	0.00018	0.00022
71	eR	min	Co #9	0	0	0	0	0.00013	0	0.00003	0.00013
212		max	Co #7	0.2	-5.6	-50.9	51.2	-0.01444	-0.00380	0.00106	0.01497
215		max	Co #7	-0.1	-5.6	-50.9	51.2	-0.01444	0.00382	-0.00106	0.01497

C: Extremal component; min, max.: Extreme type; Case: Load case of extreme; eX: Translation in X direction; eY: Translation in Y direction; eZ: Translation in Z direction; eR: Resultant translation; fX: Rotation in X direction; fY: Rotation in Y direction; fZ: Rotation in Z direction; fR: Resultant rotation.

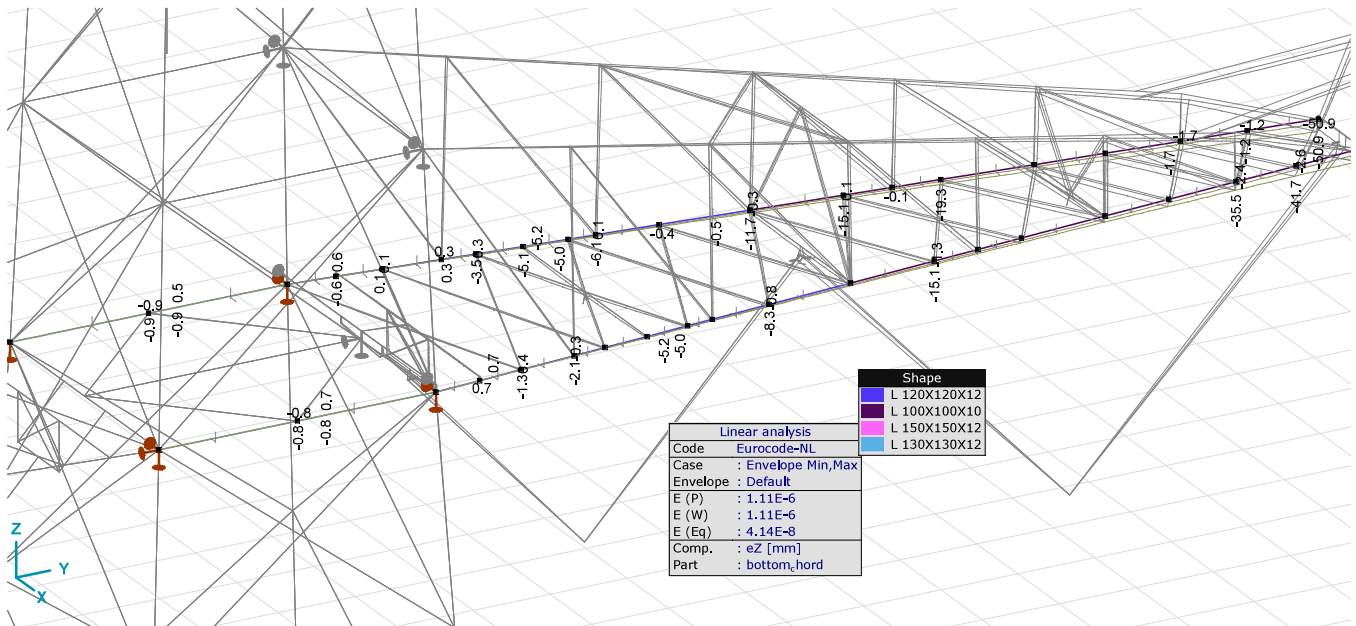

LCA_bottom_chord, Linear, Envelope (Default), eZ [mm], Diagram

Beam internal forces [Linear, Envelope (Default), LCA]

Ext.	Sh.	Cross-section name	C	min. max.	Case	Loc. [m]	Node	Nx [kN]	Vy [kN]	Vz [kN]	Tx [kNm]	My [kNm]	Mz [kNm]
497	21	L 130X130X12	Nx	min	Co #10	0	(292)	-302.8	0.2	0	0	0.1	-0.3
498	21	L 130X130X12		min	Co #10	0	(71)	-302.8	0.2	0	0	0	0
499	21	L 130X130X12		max	Co #10	0	(293)	164.3	0.2	-0.1	0	0.3	0.4
500	21	L 130X130X12		max	Co #10	0	(73)	164.3	0.2	-0.1	0	0.5	0.9

Sh.: Cross-section; C: Extremal component; min, max.: Extreme type; Case: Load case of extreme; Loc.: Cross-section local x position on the beam; Nx: Axial force; Vy: Shear force in local y direction; Vz: Shear force in local z direction; Tx: Torsional moment; My: Flexural moment about local y axis; Mz: Flexural moment about local z axis;

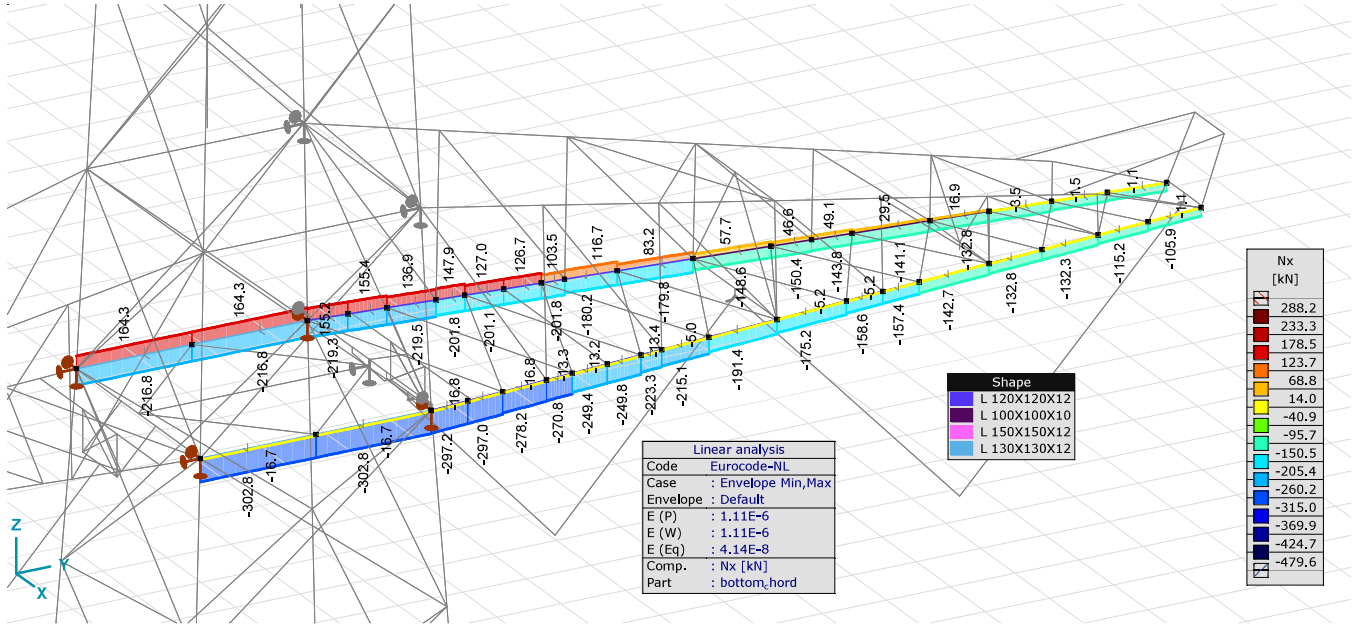

LCA_bottom_chord, Linear, Envelope (Default), Nx [kN], Filled diagram

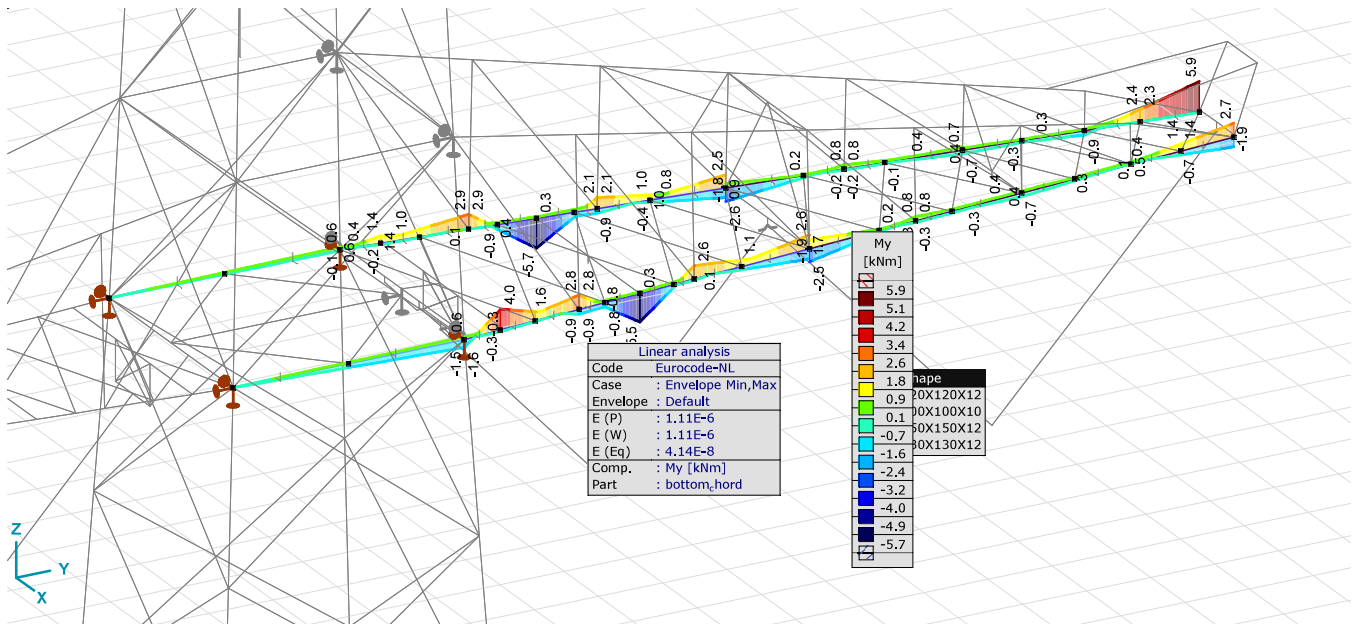

LCA_bottom_chord, Linear, Envelope (Default), My [kNm], Filled diagram

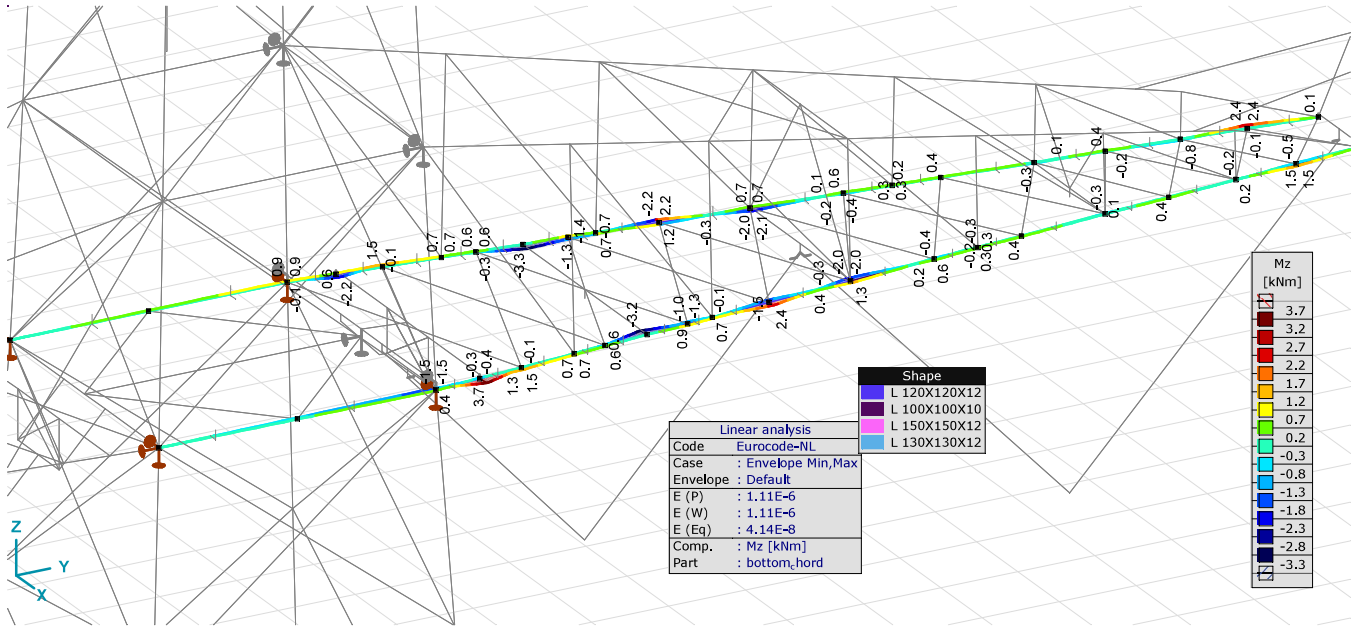

LCA_bottom_chord, Linear, Envelope (Default), Mz [kNm], Filled diagram

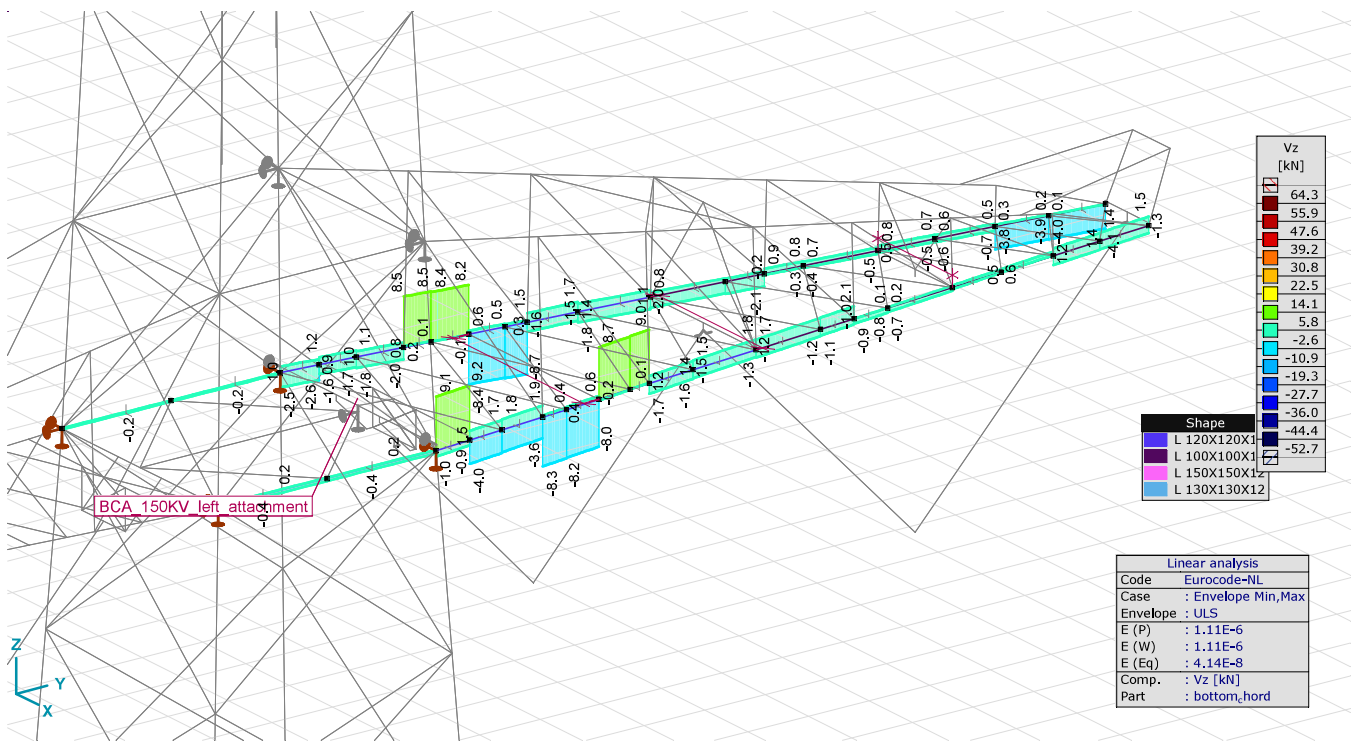

LCA_bottom_chord, Linear, Envelope (ULS), Vz [kN], Filled diagram

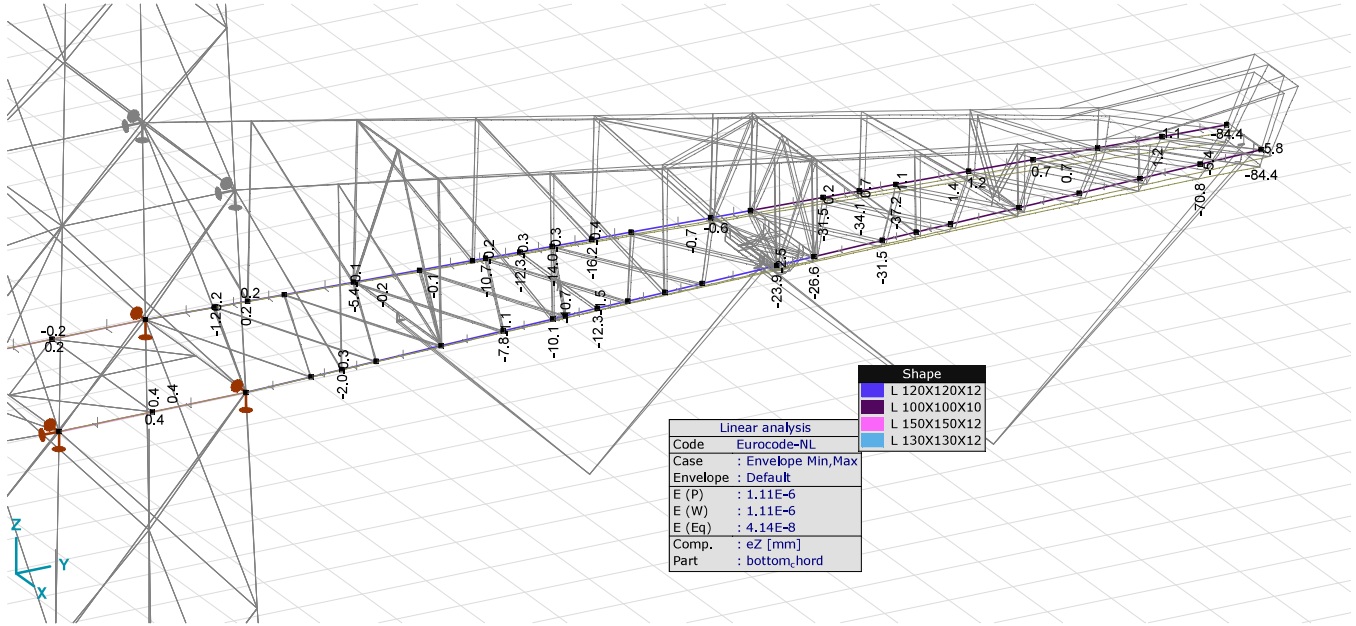

MCA_bottom_chord, Linear, Envelope (Default), eZ [mm], Diagram

Beam internal forces [Linear, Envelope (Default), MCA]

Ext.	Sh.	Cross-section name	C	min. max.	Case	Loc. [m]	Node	Nx [kN]	Vy [kN]	Vz [kN]	Tx [kNm]	My [kNm]	Mz [kNm]
493	20	L 150X150X12	Nx	min	Co #11	0	(177)	-479.6	0.4	0	0	0	-0.6
494	20	L 150X150X12		min	Co #11	0	(61)	-479.6	0.4	0	0	0	0
495	20	L 150X150X12		max	Co #11	0	(295)	273.9	0.4	-0.1	0	0.2	0.6
496	20	L 150X150X12		max	Co #11	0	(63)	273.9	0.4	-0.1	0	0.3	1.3
222	6	L 120X120X12	Tx	min	Co #11	0	(266)	124.4	-0.7	-0.4	-0.1	-0.1	-0.4
235	8	L 100X100X10		max	Co #11	0	(284)	-90.1	-0.4	0	0.8	-0.1	-0.2

Sh.: Cross-section; C: Extremal component, min, max.; Extreme type; Case: Load case of extreme; Loc.: Cross-section local x position on the beam; Nx: Axial force; Vy: Shear force in local y direction; Vz: Shear force in local z direction; Tx: Torsional moment; My: Flexural moment about local y axis; Mz: Flexural moment about local z axis;

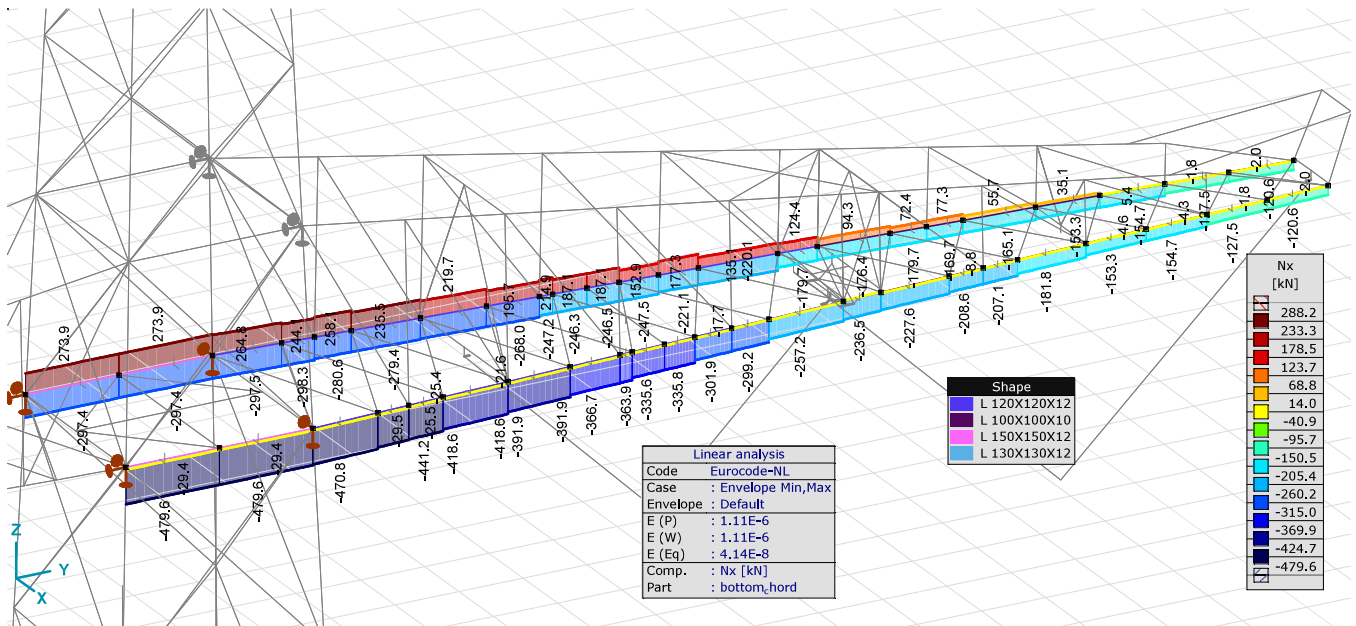

MCA_bottom_chord, Linear, Envelope (Default), Nx [kN], Filled diagram

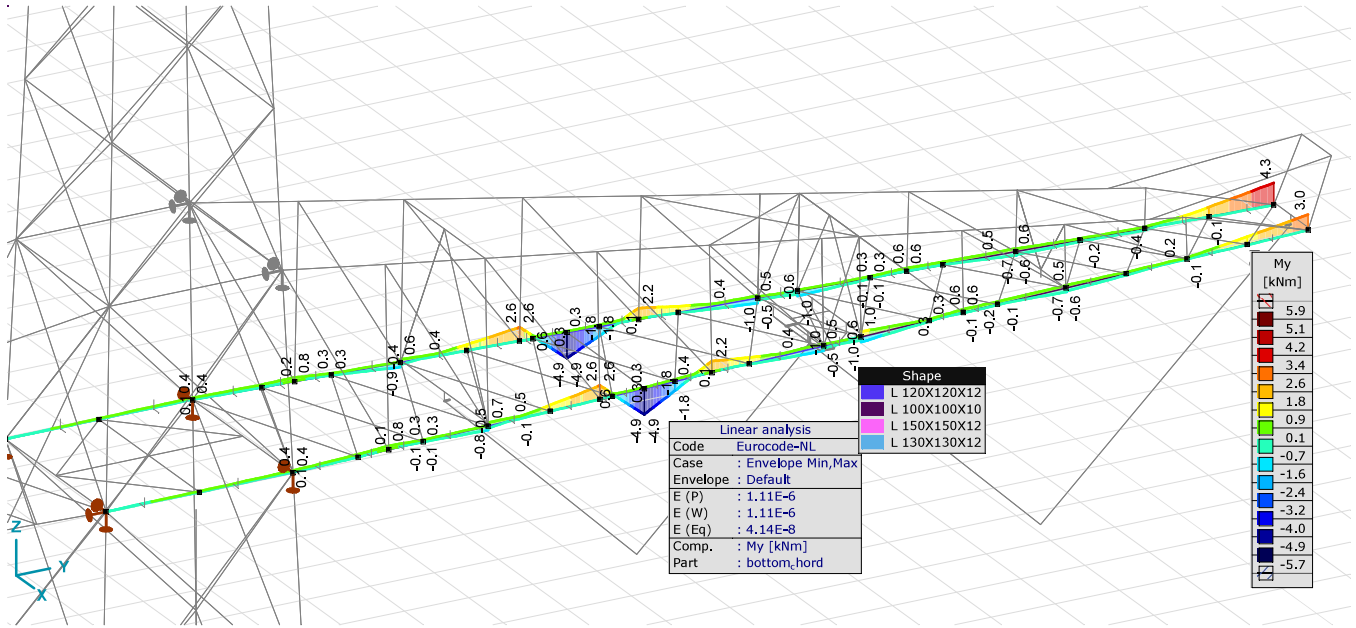

MCA_bottom_chord, Linear, Envelope (Default), My [kNm], Filled diagram

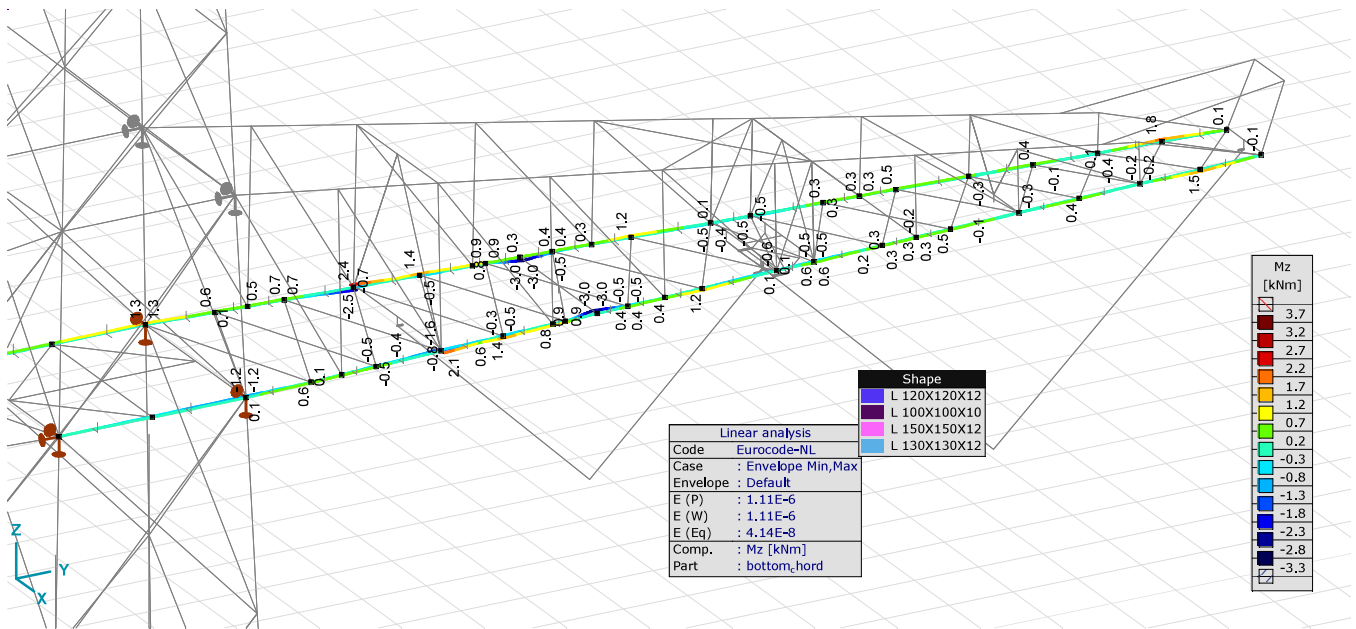

MCA_bottom_chord, Linear, Envelope (Default), Mz [kNm], Filled diagram

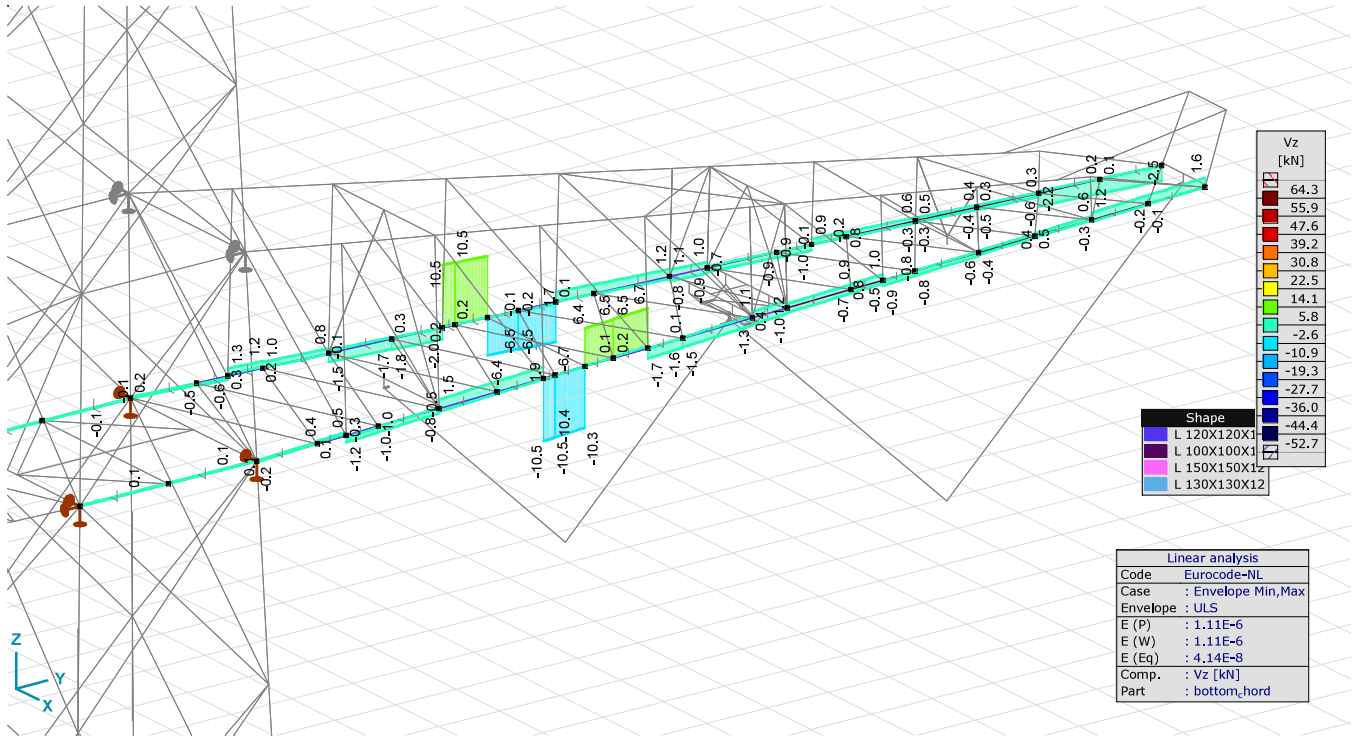

MCA_bottom_chord, Linear, Envelope (ULS), Vz [kN], Filled diagram

Beam stresses [Linear, Envelope (Default), MCA]

	Sh	Cross-section name	C	min. max.	Case	Loc. [m]	Node	Smin [N/mm ²]	Smax [N/mm ²]	Vmin [N/mm ²]	Vmax [N/mm ²]	Somin [N/mm ²]	Somax [N/mm ²]	Vymean [N/mm ²]	Vzmean [N/mm ²]
Ext															
197	6	L 120X120X12	Smin	min	Co #11	0	(60)	-198.5	-138.4	0	1.0	138.4	198.5	-0.5	0
198	6	L 120X120X12		max	Co #11	0	(296)	89.7	104.0	0	2.0	89.7	104.0	-0.3	-0.1
197	6	L 120X120X12	Smax	min	Co #11	0.944		-173.0	-169.5	0	1.1	169.5	173.0	-0.5	0
238	8	L 100X100X10		max	Co #11	0	(337)	-191.6	172.8	0	110.0	29.6	270.2	-0.9	-1.3
197	6	L 120X120X12	Vmin	min	Co #1	0	(60)	-62.6	-50.7	0	1.6	50.8	62.7	0	0
197	6	L 120X120X12		max	Co #1	0	(60)	-62.6	-50.7	0	1.6	50.8	62.7	0	0
238	8	L 100X100X10	Vmax	min	Co #14	0.687		-38.3	5.1	0	0	5.1	38.3	-0.3	-0.3
236	8	L 100X100X10		max	Co #11	0	(333)	-74.6	55.1	0	113.1	9.9	203.8	1.2	-1.2
233	8	L 100X100X10	Somin	min	Co #4	0.785		-3.7	0	0	0.2	0.1	3.7	0	0.1
234	8	L 100X100X10		min	Co #4	0.196		-3.7	0	0	0.2	0.1	3.7	0	-0.1
197	6	L 120X120X12		max	Co #11	0.944		-173.0	-169.5	0	1.1	169.5	173.0	-0.5	0
237	8	L 100X100X10	Somax	min	Co #3	0.982	(340)	-1.1	-1.1	0	0.2	1.1	1.1	0	0.1
238	8	L 100X100X10		min	Co #1	0	(337)	-1.1	-1.1	0	0.2	1.1	1.1	0	-0.1
238	8	L 100X100X10		max	Co #11	0	(337)	-191.6	172.8	0	110.0	29.6	270.2	-0.9	-1.3
197	6	L 120X120X12	(NL) Seff Min	min		0	(60)	0	0	0	0	0	0	0	0
197	6	L 120X120X12		max		0	(60)	0	0	0	0	0	0	0	0
197	6	L 120X120X12	(NL) Seff Min	min		0	(60)	0	0	0	0	0	0	0	0
197	6	L 120X120X12		max		0	(60)	0	0	0	0	0	0	0	0
197	6	L 120X120X12	(NL) Seff Min	min		0	(60)	0	0	0	0	0	0	0	0
197	6	L 120X120X12		max		0	(60)	0	0	0	0	0	0	0	0
197	6	L 120X120X12	(NL) Seff Min	min		0	(60)	0	0	0	0	0	0	0	0
197	6	L 120X120X12		max		0	(60)	0	0	0	0	0	0	0	0
197	6	L 120X120X12	(NL) Seff Min	min		0	(60)	0	0	0	0	0	0	0	0
197	6	L 120X120X12		max		0	(60)	0	0	0	0	0	0	0	0
197	6	L 120X120X12	(NL) Seff Min	min		0	(60)	0	0	0	0	0	0	0	0
197	6	L 120X120X12		max		0	(60)	0	0	0	0	0	0	0	0
212	6	L 120X120X12	Vymean	min	Co #16	0	(541)	-156.0	0	0	10.0	0.8	156.0	-2.7	3.7
211	6	L 120X120X12		max	Co #16	0	(311)	-70.0	-39.2	0	10.0	39.2	70.0	2.7	-3.7
207	6	L 120X120X12	Vzmean	min	Co #17	0	(236)	-92.4	23.6	0	8.0	23.8	93.5	0.2	-3.8
208	6	L 120X120X12		max	Co #17	0.200	(242)	-92.6	23.7	0	8.0	24.0	93.6	-0.2	3.8

Sh: Cross-section; C: Extremal component; min, max.: Extreme type; Case: Load case of extreme; Loc.: Cross-section local x position on the beam; Smin: Axial stress cross-section minimum; Smax: Axial stress cross-section maximum; Vmin: Shear stress cross-section minimum; Vmax: Shear stress cross-section maximum; Somin: Von Mises stress cross-section minimum; Somax: Von Mises stress cross-section maximum; Vymean: Shear stress in local y direction; Vzmean: Shear stress in local z direction.

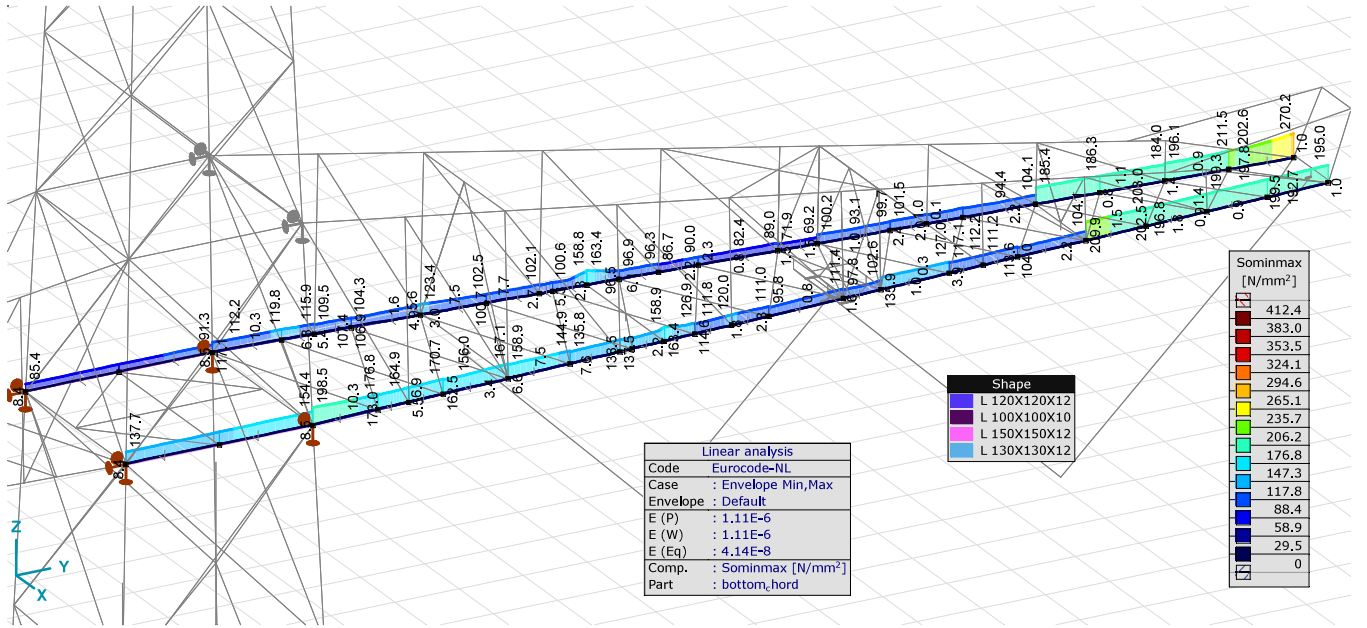

MCA_bottom_chord, Linear, Envelope (Default), Sominmax [N/mm²], Filled diagram

Nodal displacements [Linear, Envelope (Default), UCA]

	C	min.	max.	Case	eX [mm]	eY [mm]	eZ [mm]	eR [mm]	fX [rad]	fY [rad]	fZ [rad]	fR [rad]
Ext.												
434	eX	min		Co #15	-0.4	-0.1	-0.2	0.5	-0.00005	0	0.00013	0.00014
423		max		Co #12	64.4	-5.2	-33.7	72.9	-0.02002	0.30458	-0.00768	0.30533
429		max		Co #12	64.4	0.7	-2.5	64.4	0.00710	0.30534	-0.00443	0.30545
429	eY	min		Co #7	-0.2	-8.2	-73.9	74.4	-0.01592	-0.00004	0.00206	0.01605
454		max		Co #12	25.6	2.2	-0.2	25.7	0.00161	0.02045	-0.00480	0.02107
429	eZ	min		Co #7	-0.2	-8.2	-73.9	74.4	-0.01592	-0.00004	0.00206	0.01605
632		max		Co #12	37.4	2.1	0.7	37.4	0.00068	0.01920	-0.00580	0.02006
45	eR	min		Co #10	0	0	0	0	0.00008	0	0.00002	0.00008
429		max		Co #7	-0.2	-8.2	-73.9	74.4	-0.01592	-0.00004	0.00206	0.01605

C: Extremal component, min, max.: Extreme type, Case: Load case of extreme, eX: Translation in X direction, eY: Translation in Y direction, eZ: Translation in Z direction, eR: Resultant translation, fX: Rotation in X direction, fY: Rotation in Y direction, fZ: Rotation in Z direction, fR: Resultant rotation.

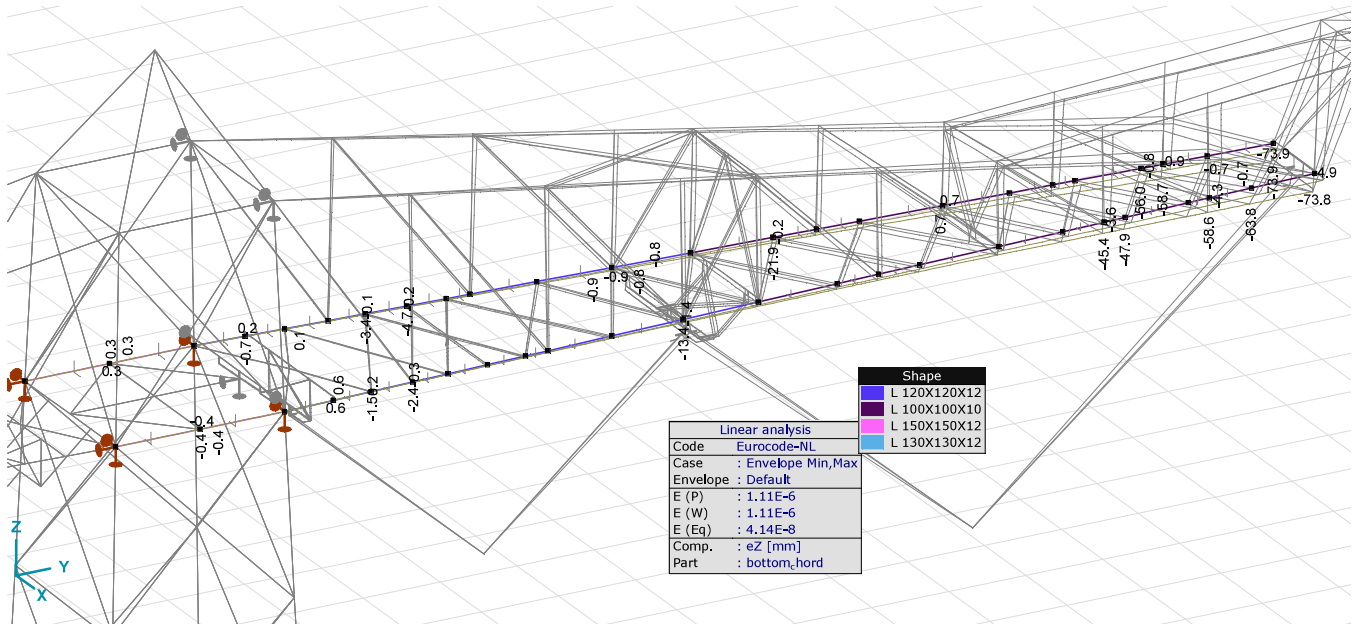

UCA_bottom_chord, Linear, Envelope (Default), eZ [mm], Diagram

Beam internal forces [Linear, Envelope (Default), UCA]

Ext.	Sh.	Cross-section name	C	min. max.	Case	Loc. [m]	Node	Nx [kN]	Vy [kN]	Vz [kN]	Tx [kNm]	My [kNm]	Mz [kNm]
501	20	L 150X150X12	Nx	min	Co #12	0	(432)	-463.0	0.6	0	0	0	-0.7
502	20	L 150X150X12		min	Co #12	0	(45)	-463.0	0.6	0	0	0	0
503	20	L 150X150X12		max	Co #12	0	(434)	287.8	0.8	-0.5	0	0.5	0.9
504	20	L 150X150X12		max	Co #12	0	(47)	287.8	0.8	-0.5	0	1.1	1.9

Sh.: Cross-section; C: Extremal component; min, max.: Extreme type; Case: Load case of extreme; Loc.: Cross-section local x position on the beam; Nx: Axial force; Vy: Shear force in local y direction; Vz: Shear force in local z direction; Tx: Torsional moment; My: Flexural moment about local y axis; Mz: Flexural moment about local z axis;

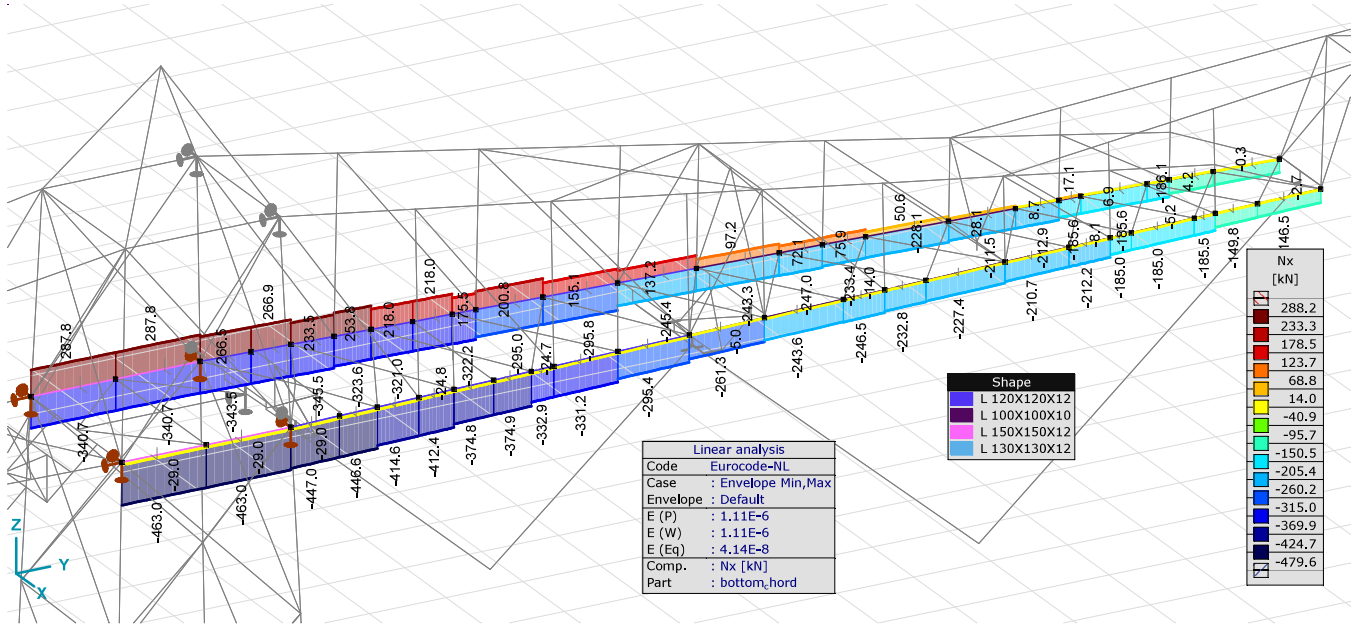

UCA_bottom_chord, Linear, Envelope (Default), Nx [kN], Filled diagram

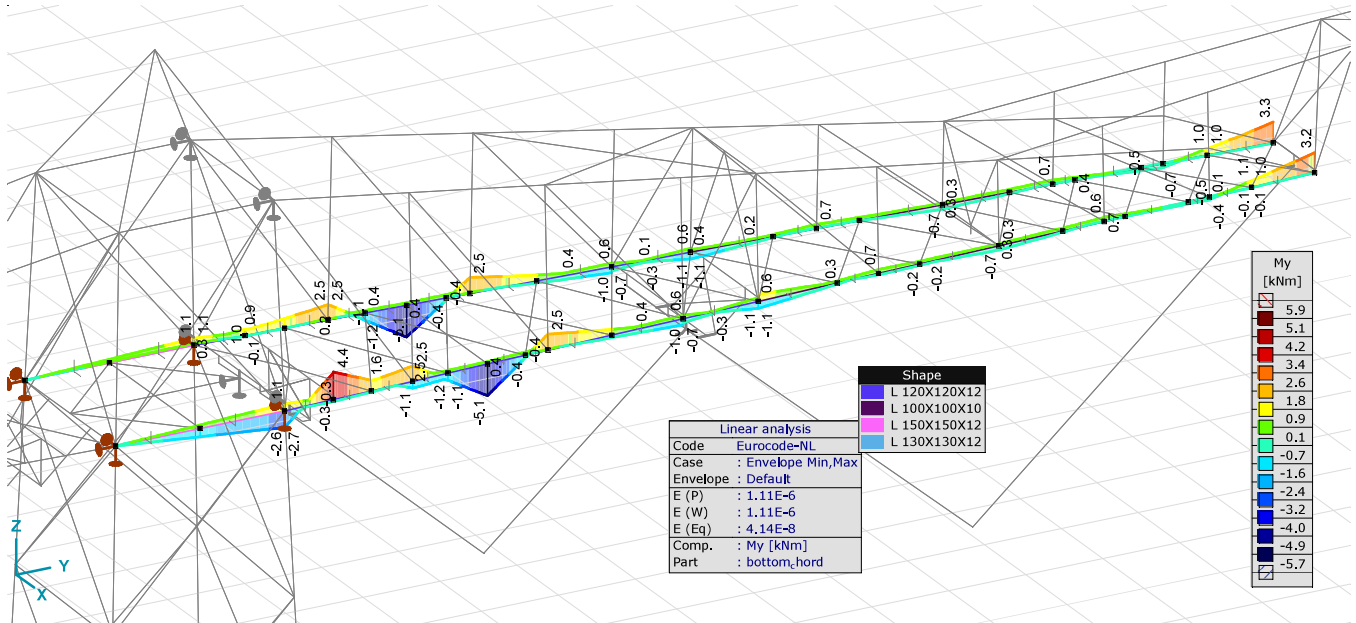

UCA_bottom_chord, Linear, Envelope (Default), My [kNm], Filled diagram

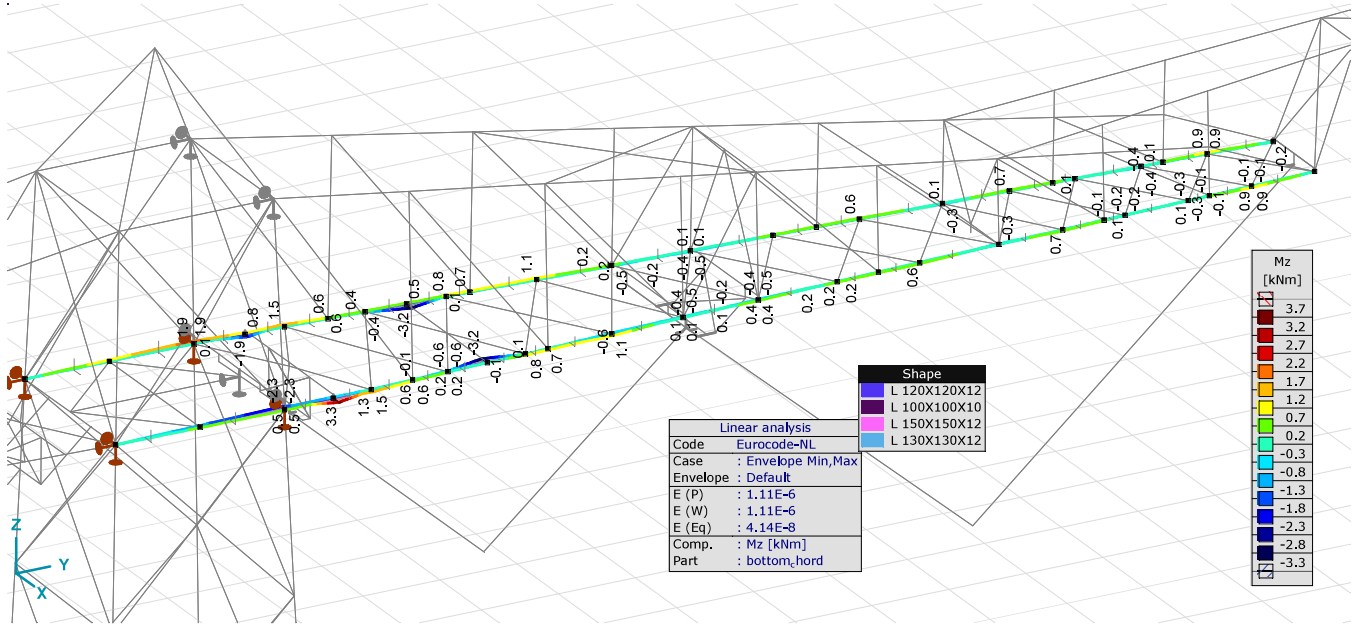

UCA_bottom_chord, Linear, Envelope (Default), Mz [kNm], Filled diagram

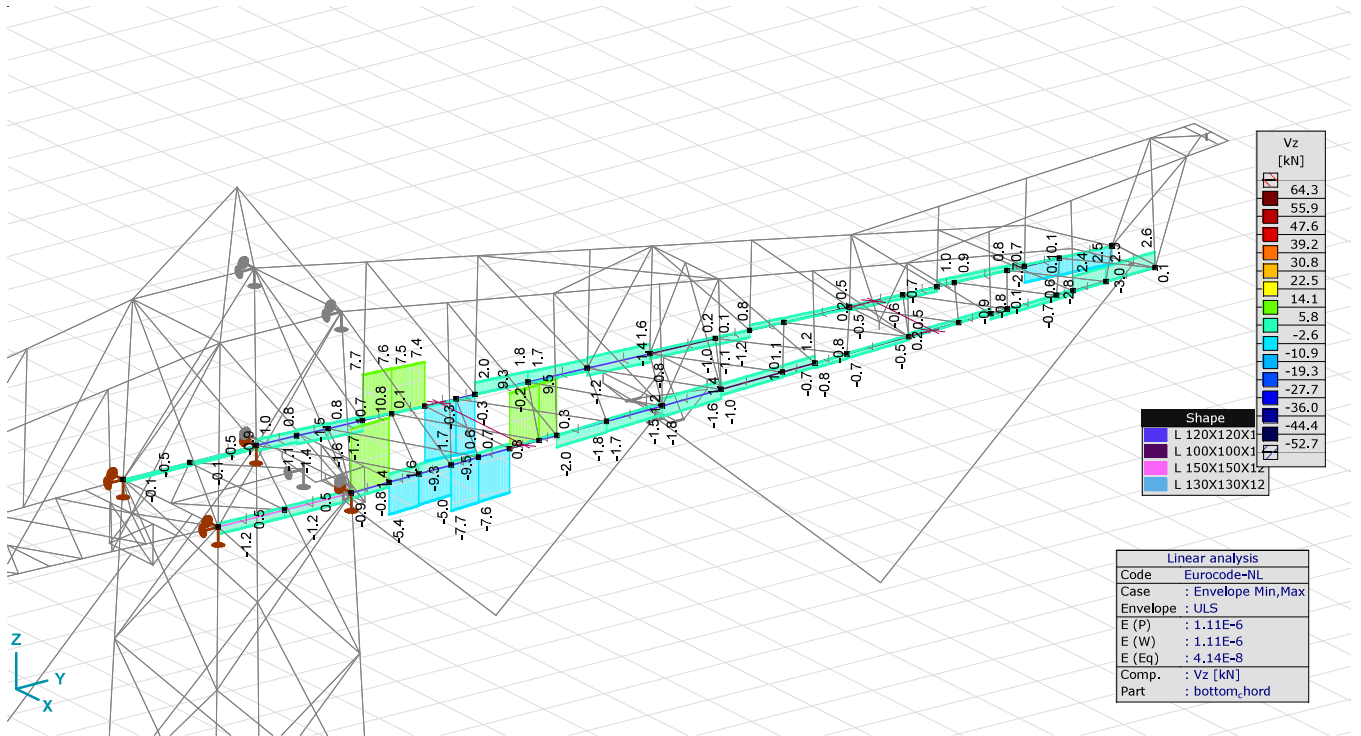

UCA_bottom_chord, Linear, Envelope (ULS), Vz [kN], Filled diagram

Beam internal forces [Linear, Envelope (Default), Insulators_assembly]

Sh.	Cross-section name	C	min. max.	Case	Loc. [m]	Node	Nx [kN]	Vy [kN]	Vz [kN]	Tx [kNm]	My [kNm]	Mz [kNm]						
1	23	HE 220 B	Nx	min	Co #10	L=1.217	(681)	-38.1	-9.1	16.6	-3.7	0	0					
				max	Co #1	0	(681)	25.5	-33.6	-29.1	5.4	0	0					
				Tx	min	Co #10	0	(681)	-38.1	-9.1	16.6	-3.7	0	0				
					max	Co #1	0	(681)	25.5	-33.6	-29.1	5.4	0	0				
				My	min	Co #1	1.217	(534)	25.5	-32.7	-29.1	5.4	-35.4	40.4				
					max	Co #6	1.217	(534)	-13.1	-27.4	26.4	-2.9	32.1	33.9				
				Mz	min	Co #10	0	(681)	-38.1	-9.1	16.6	-3.7	0	0				
					max	Co #3	1.217	(534)	20.4	-42.2	-19.4	4.3	-23.6	51.9				
				2	23	HE 220 B	Nx	min	Co #6	L=1.217	(534)	-13.1	27.4	-26.4	2.9	32.1	33.9	
								max	Co #1	0	(534)	25.5	32.7	29.1	-5.4	-35.4	40.4	
								Tx	min	Co #1	0	(534)	25.5	32.7	29.1	-5.4	-35.4	40.4
									max	Co #6	0	(534)	-13.1	27.4	-26.4	2.9	32.1	33.9
My	min	Co #1	0					(534)	25.5	32.7	29.1	-5.4	-35.4	40.4				
	max	Co #6	0					(534)	-13.1	27.4	-26.4	2.9	32.1	33.9				
Mz	min	Co #1	1.217					(682)	25.5	33.6	29.1	-5.4	0	0				
	max	Co #3	0					(534)	20.4	42.2	19.4	-4.3	-23.6	51.9				
3	15	HE 180 B	Nx					min	Co #10	L=0.500	(646)	-21.8	1.1	-20.7	-0.9	0	0	
								max	Co #5	0	(646)	6.7	-27.9	-26.1	3.7	0	0	
								Tx	min	Co #10	0	(646)	-21.8	1.1	-20.7	-0.9	0	0
									max	Co #7	0	(646)	6.6	-28.5	-26.6	3.7	0	0
				My	min	Co #7	0.500	(536)	6.6	-28.2	-26.6	3.7	-13.3	14.2				
					max	Co #2	0.500	(536)	-0.3	0	0	0	0	0.1				
				Mz	min	Co #10	0.500	(536)	-21.8	1.3	-20.7	-0.9	-10.4	-0.6				
					max	Co #7	0.500	(536)	6.6	-28.2	-26.6	3.7	-13.3	14.2				
				4	15	HE 180 B	Nx	min	Co #17	L=0.500	(536)	-0.8	0	0	0	0	0.1	
								max	Co #10	0	(536)	30.7	13.4	29.1	-7.0	-14.6	6.8	
								Tx	min	Co #10	0	(536)	30.7	13.4	29.1	-7.0	-14.6	6.8
									max	Co #6	0	(536)	-0.5	0	0	0	0	0.1
My	min	Co #10	0					(536)	30.7	13.4	29.1	-7.0	-14.6	6.8				
	max	Co #2	0					(536)	-0.3	0	0	0	0	0.1				
Mz	min	Co #4	0.500					(645)	0.1	0.3	0	0	0	0				
	max	Co #7	0					(536)	6.6	28.2	26.6	-3.7	-13.3	14.2				
5	15	HE 180 B	Nx					min	Co #14	L=1.273	(643)	-11.8	-2.8	12.0	-1.7	-2.2	-0.5	
								max	Co #16	0	(643)	5.2	-0.6	0	0	0	0.2	
								Tx	min	Co #8	0	(643)	-3.4	-14.9	14.8	-2.1	-3.6	-0.7
									max	Co #9	0	(643)	0.2	-0.7	0	0	0	0
				My	min	Co #8	0	(643)	-3.4	-14.9	14.8	-2.1	-3.6	-0.7				
					max	Co #8	1.273	(544)	-3.4	-14.2	14.8	-2.1	15.2	17.8				
				Mz	min	Co #6	0	(643)	-5.5	-14.5	14.4	-2.0	-3.5	-0.8				
					max	Co #8	1.273	(544)	-3.4	-14.2	14.8	-2.1	15.2	17.8				
				6	15	HE 180 B	Nx	min	Co #11	L=0.500	(641)	-23.0	1.0	-23.6	1.3	0	0	
								max	Co #7	0	(641)	4.4	-28.4	-29.7	4.2	0	0	
								Tx	min	Co #16	0	(641)	-0.1	-0.3	0	0	0	0
									max	Co #7	0	(641)	4.4	-28.4	-29.7	4.2	0	0
My	min	Co #7	0.500					(558)	4.4	-28.1	-29.7	4.2	-14.9	14.1				
	max	Co #17	0.500					(558)	-0.2	0	0	0	0	0.1				
Mz	min	Co #11	0.500					(558)	-23.0	1.3	-23.6	1.3	-11.8	-0.6				
	max	Co #7	0.500					(558)	4.4	-28.1	-29.7	4.2	-14.9	14.1				
7	15	HE 180 B	Nx					min	Co #17	L=0.500	(558)	-0.2	0	0	0	0	0.1	
								max	Co #11	0	(558)	29.6	13.4	32.0	-5.5	-16.0	6.8	
								Tx	min	Co #11	0	(558)	29.6	13.4	32.0	-5.5	-16.0	6.8
									max	Co #1	0	(558)	0	0	0	0	0	0.1
				My	min	Co #11	0	(558)	29.6	13.4	32.0	-5.5	-16.0	6.8				
					max	Co #6	0	(558)	0	0	0	0	0	0.1				
				Mz	min	Co #4	0.500	(640)	0	0.3	0	0	0	0				
					max	Co #7	0	(558)	4.4	28.1	29.7	-4.2	-14.9	14.1				
				8	15	HE 180 B	Nx	min	Co #12	L=0.500	(630)	-24.3	1.1	-25.8	2.8	0	0	
								max	Co #7	0	(630)	3.3	-28.4	-32.1	4.5	0	0	
								Tx	min	Co #10	0	(630)	0	-0.3	0	0	0	0
									max	Co #7	0	(630)	3.3	-28.4	-32.1	4.5	0	0
My	min	Co #7	0.500					(572)	3.3	-28.2	-32.1	4.5	-16.1	14.2				
	max	Co #6	0.500					(572)	0	0	0	0	0	0.1				
Mz	min	Co #12	0.500					(572)	-24.3	1.3	-25.8	2.8	-12.9	-0.6				
	max	Co #7	0.500					(572)	3.3	-28.2	-32.1	4.5	-16.1	14.2				
9	15	HE 180 B	Nx					min	Co #17	L=0.500	(572)	-0.1	0	0	0	0	0.1	
								max	Co #12	0	(572)	28.2	13.4	34.2	-4.7	-17.1	6.8	
								Tx	min	Co #12	0	(572)	28.2	13.4	34.2	-4.7	-17.1	6.8
									max	Co #6	0	(572)	0	0	0	0	0	0.1
				My	min	Co #12	0	(572)	28.2	13.4	34.2	-4.7	-17.1	6.8				
					max	Co #6	0	(572)	0	0	0	0	0	0.1				
				Mz	min	Co #9	0.500	(631)	1.6	11.4	12.6	-2.1	0	0				
					max	Co #7	0	(572)	3.3	28.2	32.1	-4.5	-16.1	14.2				
				10	1	HE 160 A	Nx	min	Co #8	L=1.300	(647)	0	-2.9	-1.7	-0.3	0	0	
								max	Co #13	0	(647)	0	-2.0	-1.0	-0.2	0	0	
								Tx	min	Co #8	0	(647)	0	-2.9	-1.7	-0.3	0	0
									max	Co #9	0	(647)	0	0	-0.2	0	0	0
My	min	Co #8	1.300					(486)	0	-2.9	-1.3	-0.3	-2.0	3.7				

Beam internal forces [Linear, Envelope (Default), Insulators_assembly]

	Sh.	Cross-section name	C	min. max.	Case	Loc. [m]	Node	Nx [kN]	Vy [kN]	Vz [kN]	Tx [kNm]	My [kNm]	Mz [kNm]				
20	16	HE 160 B	Nx	min	Co #1	L=0.500	0 (548)	-18.9	0.1	-3.5	-1.0	-13.1	-6.5				
				max	Co #11	0 (548)	10.7	1.3	0.6	0.6	3.0	4.1					
				Tx	min	Co #1	0 (548)	-18.9	0.1	-3.5	-1.0	-13.1	-6.5				
					max	Co #6	0 (548)	1.7	-0.7	2.9	0.9	0.7	6.4				
				My	min	Co #1	0.500 (554)	-18.9	0.1	-3.3	-1.0	-14.8	-6.5				
					max	Co #11	0.500 (554)	10.7	1.3	0.8	0.6	3.3	3.4				
				Mz	min	Co #1	0.500 (554)	-18.9	0.1	-3.3	-1.0	-14.8	-6.5				
					max	Co #6	0.500 (554)	1.7	-0.7	3.1	0.9	2.2	6.7				
				21	16	HE 160 B	Nx	min	Co #1	L=0.500	0 (554)	-18.4	-0.2	3.2	1.0	-14.8	-6.7
								max	Co #6	0 (554)	1.8	0.7	-3.1	-0.9	2.2	6.7	
								Tx	min	Co #6	0 (554)	1.8	0.7	-3.1	-0.9	2.2	6.7
									max	Co #1	0 (554)	-18.4	-0.2	3.2	1.0	-14.8	-6.7
My	min	Co #1	0 (554)					-18.4	-0.2	3.2	1.0	-14.8	-6.7				
	max	Co #11	0 (554)					-2.1	2.5	-3.7	-0.7	3.3	6.9				
Mz	min	Co #1	0 (554)					-18.4	-0.2	3.2	1.0	-14.8	-6.7				
	max	Co #11	0 (554)					-2.1	2.5	-3.7	-0.7	3.3	6.9				
22	16	HE 160 B	Nx					min	Co #3	L=0.420	0 (639)	-0.9	-11.3	37.7	-1.0	0	0
								max	Co #11	0 (556)	12.7	13.3	1.6	0.8	-0.7	5.6	
								Tx	min	Co #1	0 (556)	-0.7	-15.6	37.4	-1.3	-15.8	-6.6
									max	Co #6	0 (556)	-0.7	15.2	-2.6	1.2	1.0	6.4
				My	min	Co #3	0 (556)	-0.9	-11.3	37.6	-1.0	-15.8	-4.8				
					max	Co #6	0 (556)	-0.7	15.2	-2.6	1.2	1.0	6.4				
				Mz	min	Co #1	0 (556)	-0.7	-15.6	37.4	-1.3	-15.8	-6.6				
					max	Co #6	0 (556)	-0.7	15.2	-2.6	1.2	1.0	6.4				
				23	1	HE 160 A	Nx	min	Co #7	L=0.598	0 (624)	0	-4.0	-1.9	-0.4	0	0
								max	Co #15	0 (624)	0	-5.8	-2.9	-0.5	0	0	
								Tx	min	Co #8	0 (624)	0	-7.5	-3.9	-0.7	0	0
									max	Co #10	0 (624)	0	-0.1	-0.1	0	0	0
My	min	Co #8	0.598 (506)					0	-7.5	-3.8	-0.7	-2.3	4.5				
	max	Co #2	0 (624)					0	-5.2	-2.9	-0.5	0	0				
Mz	min	Co #6	0 (624)					0	-6.9	-3.8	-0.6	0	0				
	max	Co #8	0.598 (506)					0	-7.5	-3.8	-0.7	-2.3	4.5				
24	1	HE 160 A	Nx					min	Co #7	L=0.598	0 (511)	0	4.0	1.7	0.4	-1.1	2.4
								max	Co #15	0 (511)	0	7.3	4.0	0.7	-2.5	4.4	
								Tx	min	Co #10	0 (511)	0	0.1	0	0	0	0
									max	Co #8	0 (511)	0	7.5	3.8	0.7	-2.3	4.5
				My	min	Co #15	0 (511)	0	7.3	4.0	0.7	-2.5	4.4				
					max	Co #3	0.598 (625)	0	3.1	1.6	0.3	0	0				
				Mz	min	Co #15	0.598 (625)	0	7.3	4.2	0.7	0	0				
					max	Co #8	0 (511)	0	7.5	3.8	0.7	-2.3	4.5				
				25	1	HE 160 A	Nx	min	Co #7	L=1.000	0 (506)	0	4.0	5.0	0.4	-1.1	2.4
								max	Co #15	0.500 (651)	0	-9.8	-10.6	-0.9	2.8	-0.5	
								Tx	min	Co #15	0.500 (651)	0	-9.8	-10.6	-0.9	2.8	-0.5
									max	Co #6	0 (506)	0	9.7	10.4	0.9	-2.2	4.1
My	min	Co #15	1.000 (511)					0	-9.8	-10.4	-0.9	-2.5	4.4				
	max	Co #8	0.500 (651)					0	9.7	10.9	0.9	3.1	-0.4				
Mz	min	Co #6	0.500 (651)					0	9.7	10.5	0.9	3.0	-0.7				
	max	Co #8	0 (506)					0	9.7	10.7	0.9	-2.3	4.5				
26	1	HE 160 A	Nx					min	Co #15	L=0.570	0 (633)	-14.2	0.8	16.2	0	0	0
								max	Co #7	0 (633)	1.2	0.4	-0.6	0	0	0	
								Tx	min	Co #15	0 (633)	-14.2	0.8	16.2	0	0	0
									max	Co #10	0 (633)	0.2	0	-0.6	0	0	0
				My	min	Co #5	0.570 (512)	1.1	0	-0.5	0	-0.3	0				
					max	Co #15	0.570 (512)	-14.2	0.8	16.4	0	9.3	-0.4				
				Mz	min	Co #8	0.570 (512)	0.8	1.0	-0.3	0	-0.2	-0.5				
					max	Co #12	0 (633)	0.4	0.4	-0.6	0	0	0				
				27	1	HE 160 A	Nx	min	Co #10	L=0.570	0 (515)	0.2	0	0.5	0	-0.3	0
								max	Co #15	0 (515)	12.0	-0.3	-2.2	0	1.2	-0.2	
								Tx	min	Co #12	0 (515)	0.4	-0.4	0.4	0	-0.3	-0.2
									max	Co #8	0 (515)	0.8	-1.0	0.3	0	-0.2	-0.5
My	min	Co #5	0 (515)					1.1	0	0.5	0	-0.3	0				
	max	Co #15	0 (515)					12.0	-0.3	-2.2	0	1.2	-0.2				
Mz	min	Co #8	0 (515)					0.8	-1.0	0.3	0	-0.2	-0.5				
	max	Co #8	0.570 (634)					0.8	-1.0	0.5	0	0	0				
28	1	HE 160 A	Nx					min	Co #15	L=1.000	0 (512)	-0.6	-0.3	-8.2	0	9.3	-0.4
								max	Co #7	0 (512)	1.1	0	-0.1	0	-0.3	-0.3	
								Tx	min	Co #15	0 (512)	-0.6	-0.3	-8.2	0	9.3	-0.4
									max	Co #8	0 (512)	0.7	0	-0.1	0	-0.2	-0.6
				My	min	Co #5	0.500 (664)	1.0	0	0	0	-0.4	0				
					max	Co #15	0 (512)	-0.6	-0.3	-8.2	0	9.3	-0.4				
				Mz	min	Co #8	0 (512)	0.7	0	-0.1	0	-0.2	-0.6				
					max	Co #5	1.000 (515)	1.0	0	0.1	0	-0.3	0				
				29	16	HE 160 B	Nx	min	Co #12	L=0.363	0 (659)	-11.4	-9.6	8.4	-1.5	-3.1	-3.5
								max	Co #9	0 (659)	1.6	-4.4	13.3	-0.7	-4.9	-1.6	
								Tx	min	Co #6	0 (659)	-2.3	-15.7	27.9	-2.3	-10.2	-5.7

Beam internal forces [Linear, Envelope (Default), Insulators_assembly]

Sh.	Cross-section name	C	min. max.	Case	Loc. [m]	Node	Nx [kN]	Vy [kN]	Vz [kN]	Tx [kNm]	My [kNm]	Mz [kNm]
		Mz	max	Co #1	0.563	(677)	7.8	-0.1	0.1	0	0.1	0
			min	Co #6	0.563	(677)	2.3	0	0	0	0	0
			max	Co #1	0.563	(677)	8.2	0.1	0	0	0	0.1
58	4 L 50X 50X 5				L=1.127							
		Nx	min	Co #15	1.127	(597)	-6.6	0	0	0	0	0
			max	Co #8	0	(341)	8.3	0	0	0	0	0
		Tx	min	Co #1	0	(341)	2.7	0	0	0	0	0
			max	Co #6	0	(341)	7.5	0.1	0	0	0	0
		My	min	Co #9	0.563	(678)	7.0	0.1	-0.1	0	-0.1	-0.1
			max	Co #12	0.563	(678)	-6.2	0	-0.1	0	0	0
		Mz	min	Co #9	0.563	(678)	7.0	0.1	-0.1	0	-0.1	-0.1
			max	Co #15	0.563	(678)	-6.6	0	-0.1	0	0	0
59	4 L 50X 50X 5				L=1.127							
		Nx	min	Co #9	0	(594)	0.1	-0.1	0.1	0	0	0
			max	Co #12	1.127	(345)	14.9	-0.1	0.1	0	0	0
		Tx	min	Co #6	0.563	(678)	7.5	-0.1	0	0	0	0
			max	Co #1	0.563	(678)	2.7	0	0	0	0	0
		My	min	Co #15	0.563	(678)	11.3	0.1	0	0	0	0
			max	Co #9	0.563	(678)	0.1	-0.1	0.1	0	0.1	0.1
		Mz	min	Co #12	0.563	(678)	14.9	-0.1	0	0	0	0
			max	Co #9	0.563	(678)	0.1	-0.1	0.1	0	0.1	0.1
60	16 HE 160 B				L=0.500							
		Nx	min	Co #15	0	(599)	-12.6	-0.3	12.8	-1.6	0	0
			max	Co #6	0	(599)	0	-14.0	15.6	-1.9	0	0
		Tx	min	Co #8	0	(599)	0	-14.4	16.2	-1.9	0	0
			max	Co #17	0	(599)	0	-0.2	0	0	0	0
		My	min	Co #2	0	(599)	0	-10.5	11.7	-1.4	0	0
			max	Co #8	0.500	(598)	0	-14.2	16.2	-1.9	8.1	7.2
		Mz	min	Co #1	0	(599)	0	-0.2	0	0	0	0
			max	Co #8	0.500	(598)	0	-14.2	16.2	-1.9	8.1	7.2
61	16 HE 160 B				L=0.500							
		Nx	min	Co #7	0	(598)	-0.1	6.6	-7.5	0.9	3.8	3.4
			max	Co #15	0	(598)	13.6	6.3	-17.0	1.5	8.5	3.2
		Tx	min	Co #5	0	(598)	-0.1	0	0	0	0	0.1
			max	Co #8	0	(598)	0	14.2	-16.2	1.9	8.1	7.2
		My	min	Co #9	0.500	(600)	0	5.9	-6.5	0.8	0	0
			max	Co #15	0	(598)	13.6	6.3	-17.0	1.5	8.5	3.2
		Mz	min	Co #7	0.500	(600)	-0.1	6.8	-7.5	0.9	0	0
			max	Co #8	0	(598)	0	14.2	-16.2	1.9	8.1	7.2
62	2 L 60X 60X 6				L=0.722							
		Nx	min	Co #5	0.722	(601)	0	0	0	0	0	0
			max	Co #8	0	(582)	22.4	0	0	0	0	0
		Tx	min	Co #8	0	(582)	22.4	0	0	0	0	0
			max	Co #15	0	(582)	17.9	0	0	0	0	0
		My	min	Co #1	0.361		0	0	0	0	0	0
			max	Co #8	0	(582)	22.4	0	0	0	0	0
		Mz	min	Co #15	0	(582)	17.9	0	0	0	0	0
			max	Co #15	0.722	(601)	17.9	0	0	0	0	0
63	2 L 60X 60X 6				L=0.722							
		Nx	min	Co #5	0	(602)	0	0	0	0	0	0
			max	Co #15	0.722	(583)	22.4	0	0	0	0	0
		Tx	min	Co #10	0	(602)	0	0	0	0	0	0
			max	Co #15	0	(602)	22.4	0	0	0	0	0
		My	min	Co #1	0.361		0	0	0	0	0	0
			max	Co #8	0.722	(583)	22.4	0	0	0	0	0
		Mz	min	Co #15	0	(602)	22.4	0	0	0	0	0
			max	Co #15	0.722	(583)	22.4	0	0	0	0	0
64	1 HE 160 A				L=0.100							
		Nx	min	Co #5	0	(601)	0	0	0	0	0	0
			max	Co #8	0	(601)	17.1	0	-14.4	0	0	0
		Tx	min	Co #8	0	(601)	17.1	0	-14.4	0	0	0
			max	Co #15	0	(601)	13.7	0	-11.5	0	0	0
		My	min	Co #8	0.100	(599)	17.1	0	-14.4	0	-1.4	0
			max	Co #5	0.100	(599)	0	0	0	0	0	0
		Mz	min	Co #15	0.100	(599)	13.7	0	-11.5	0	-1.2	0
			max	Co #16	0.100	(599)	0	0	0	0	0	0
65	1 HE 160 A				L=0.100							
		Nx	min	Co #5	0	(602)	0	0	0	0	0	0
			max	Co #15	0	(602)	17.1	0	-14.4	0	0	0
		Tx	min	Co #10	0	(602)	0	0	0	0	0	0
			max	Co #15	0	(602)	17.1	0	-14.4	0	0	0
		My	min	Co #15	0.100	(600)	17.1	0	-14.4	0	-1.4	0
			max	Co #5	0.100	(600)	0	0	0	0	0	0
		Mz	min	Co #15	0.100	(600)	17.1	0	-14.4	0	-1.4	0
			max	Co #15	0	(602)	17.1	0	-14.4	0	0	0
66	3 U 120				L=0.513							
		Nx	min	Co #15	0	(600)	-0.8	0	0.1	0	-0.1	0
			max	Co #10	0.513	(515)	0.3	0	0	0	0	0
		Tx	min	Co #12	0	(600)	0.2	0	0.4	0	-0.2	0
			max	Co #15	0	(600)	-0.8	0	0.1	0	-0.1	0
		My	min	Co #8	0	(600)	0.1	0	1.0	0	-0.5	0
			max	Co #10	0.513	(515)	0.3	0	0	0	0	0
		Mz	min	Co #15	0.513	(515)	-0.7	0	0.1	0	0	0
			max	Co #15	0	(600)	-0.8	0	0.1	0	-0.1	0

Beam internal forces [Linear, Envelope (Default), Insulators_assembly]

	Sh.	Cross-section name	C	min. max.	Case	Loc. [m]	Node	Nx [kN]	Vy [kN]	Vz [kN]	Tx [kNm]	My [kNm]	Mz [kNm]			
67	3	U 120	Nx	min	Co #15	L=0.513 0.513	(599)	-17.8	0	-0.8	0	-0.4	0			
				max	Co #10	0	(512)	0.3	0	0	0	0	0			
			Tx	min	Co #12	0	(512)	0.2	0	-0.4	0	0	0	0		
				max	Co #15	0	(512)	-17.7	0	-0.8	0	0	0			
			My	min	Co #8	0.513	(599)	0.1	0	-1.0	0	0	-0.5	0		
				max	Co #10	0	(512)	0.3	0	0	0	0	0	0		
			Mz	min	Co #15	0	(512)	-17.7	0	-0.8	0	0	0	0		
				max	Co #8	0.513	(599)	0.1	0	-1.0	0	0	-0.5	0		
			68	1	HE 160 A	Nx	min	Co #5	L=0.100 0	(607)	0	0	0	0	0	0
							max	Co #8	0	(607)	13.7	0	-14.2	0	0	0
Tx	min	Co #9				0	(607)	0	0	0	0	0	0	0		
	max	Co #8				0	(607)	13.7	0	-14.2	0	0	0			
My	min	Co #8				0.100	(606)	13.7	0	-14.1	0	0	-1.4	0		
	max	Co #5				0.100	(606)	0	0	0	0	0	0	0		
Mz	min	Co #7				0	(607)	6.4	0	-6.6	0	0	0	0		
	max	Co #8				0.100	(606)	13.7	0	-14.1	0	-1.4	0	0		
69	1	HE 160 A				Nx	min	Co #1	L=0.100 0	(609)	0	0	0	0	0	0
							max	Co #13	0	(609)	13.8	0	-14.3	0	0	0
			Tx	min	Co #13	0	(609)	13.8	0	-14.3	0	0	0			
				max	Co #8	0	(609)	13.7	0	-14.2	0	0	0			
			My	min	Co #13	0.100	(608)	13.8	0	-14.2	0	0	-1.4	0		
				max	Co #1	0.100	(608)	0	0	0	0	0	0			
			Mz	min	Co #13	0.100	(608)	13.8	0	-14.2	0	-1.4	0	0		
				max	Co #8	0.100	(608)	13.7	0	-14.1	0	-1.4	0	0		
			70	16	HE 160 B	Nx	min	Co #13	L=0.500 0	(606)	-12.6	-0.3	10.1	-1.2	0	0
							max	Co #10	0	(606)	0	-6.0	5.4	-0.7	0	0
Tx	min	Co #8				0	(606)	0	-14.7	13.4	-1.6	0	0			
	max	Co #9				0	(606)	0	-0.2	0	0	0	0			
My	min	Co #4				0	(606)	-0.1	-11.0	10.0	-1.2	0	0			
	max	Co #8				0.500	(605)	0	-14.5	13.4	-1.6	6.7	7.3			
Mz	min	Co #5				0	(606)	-0.1	-0.2	0	0	0	0			
	max	Co #8				0.500	(605)	0	-14.5	13.4	-1.6	6.7	7.3			
71	16	HE 160 B				Nx	min	Co #1	L=0.500 0	(605)	-0.1	0	0	0	0	0.1
							max	Co #13	0	(605)	13.7	6.4	-14.3	1.2	7.2	3.2
			Tx	min	Co #1	0	(605)	-0.1	0	0	0	0	0	0.1		
				max	Co #8	0	(605)	0	14.5	-13.4	1.6	6.7	7.3			
			My	min	Co #17	0.500	(608)	0	0.2	0	0	0	0			
				max	Co #13	0	(605)	13.7	6.4	-14.3	1.2	7.2	3.2			
			Mz	min	Co #3	0.500	(608)	-0.1	6.0	-5.3	0.6	0	0			
				max	Co #8	0	(605)	0	14.5	-13.4	1.6	6.7	7.3			
			72	2	L 60X 60X 6	Nx	min	Co #5	L=0.719 0.719	(607)	0	0	0	0	0	0
							max	Co #8	0	(580)	19.8	0	0	0	0	0
Tx	min	Co #9				0	(580)	0	0	0	0	0	0			
	max	Co #8				0	(580)	19.8	0	0	0	0	0			
My	min	Co #1				0.359	(580)	19.8	0	0	0	0	0			
	max	Co #8				0	(580)	19.8	0	0	0	0	0			
Mz	min	Co #13				0	(580)	15.0	0	0	0	0	0			
	max	Co #8				0.719	(607)	19.7	0	0	0	0	0			
73	2	L 60X 60X 6				Nx	min	Co #1	L=0.719 0	(609)	0	0	0	0	0	0
							max	Co #13	0.719	(581)	19.9	0	0	0	0	0
			Tx	min	Co #13	0	(609)	19.9	0	0	0	0	0			
				max	Co #8	0	(609)	19.7	0	0	0	0	0			
			My	min	Co #1	0.359	(581)	19.8	0	0	0	0	0			
				max	Co #8	0.719	(581)	19.8	0	0	0	0	0			
			Mz	min	Co #8	0	(609)	19.7	0	0	0	0	0			
				max	Co #13	0	(609)	19.9	0	0	0	0	0			
			76	13	HE 140 A	Nx	min	Co #1	L=0.110 0	(610)	0	0	0	0	0	0
							max	Co #16	0	(610)	61.8	0	8.5	0	0	0
Tx	min	Co #1				0	(610)	0	0	0	0	0	0			
	max	Co #1				0	(610)	0	0	0	0	0	0			
My	min	Co #17				0.110	(351)	61.8	0	-8.5	0	-0.9	0			
	max	Co #16				0.110	(351)	61.8	0	8.5	0	0.9	0			
Mz	min	Co #17				0.110	(351)	61.8	0	-8.5	0	-0.9	0			
	max	Co #16				0.110	(351)	61.8	0	8.5	0	0.9	0			
77	13	HE 140 A				Nx	min	Co #1	L=0.110 0	(611)	0	0	0	0	0	0
							max	Co #16	0	(611)	61.9	0	10.1	0	0	0
			Tx	min	Co #1	0	(611)	0	0	0	0	0	0			
				max	Co #1	0	(611)	0	0	0	0	0	0			
			My	min	Co #17	0.110	(521)	61.9	0	-10.1	0	-1.1	0			
				max	Co #16	0.110	(521)	61.9	0	10.1	0	1.1	0			
			Mz	min	Co #17	0.110	(521)	61.9	0	-10.1	0	-1.1	0			
				max	Co #16	0.110	(521)	61.9	0	10.1	0	1.1	0			
			78	13	HE 140 A	Nx	min	Co #1	L=0.110 0	(612)	0	0	0	0	0	0
							max	Co #16	0	(612)	61.8	0	11.3	0	0	0
Tx	min	Co #1				0	(612)	0	0	0	0	0	0			

Beam internal forces [Linear, Envelope (Default), Insulators_assembly]

Sh.	Cross-section name	C	min. max.	Case	Loc. [m]	Node	Nx [kN]	Vy [kN]	Vz [kN]	Tx [kNm]	My [kNm]	Mz [kNm]	
			max	Co #14	0	(544)	14.5	4.3	-15.5	1.7	15.2	6.3	
			min	Co #1	0	(544)	2.6	0	0	0	-0.1	0.6	
			max	Co #8	0	(544)	-3.4	14.3	-15.0	2.1	15.2	17.8	
			min	Co #14	1.253	(642)	1.3	-2.3	10.1	0.7	-4.8	0	
			max	Co #8	0	(544)	-3.4	14.3	-15.0	2.1	15.2	17.8	
			min	Co #6	1.273	(644)	-21.2	5.9	17.2	0.9	-3.6	-1.3	
			max	Co #8	0	(544)	-3.4	14.3	-15.0	2.1	15.2	17.8	
546	13	HE 140 A			L=1.716								
			Nx	min	Co #6	0.858	(523)	-2.8	0	0	0	-0.1	0
				max	Co #1	0.858	(523)	5.4	0	0	0	-0.1	0
			Tx	min	Co #17	0	(152)	0.5	-5.6	-31.1	-0.6	0	0
				max	Co #17	0.858	(523)	0.5	5.6	30.9	0.6	-26.6	4.8
			My	min	Co #17	0.858	(523)	0.5	-5.6	-30.9	-0.6	-26.6	4.8
				max	Co #10	0	(152)	-1.9	0	-0.2	-0.3	0	0
			Mz	min	Co #16	0.858	(523)	-0.4	5.6	-30.9	0.6	-26.6	-4.8
				max	Co #17	0.858	(523)	0.5	5.6	30.9	0.6	-26.6	4.8
547	13	HE 140 A			L=1.458								
			Nx	min	Co #6	0.729	(521)	-0.1	0	0	0	-0.1	0
				max	Co #7	0	(276)	6.3	0	0.1	0	0	0
			Tx	min	Co #17	0	(276)	0.9	-5.1	-31.1	-0.5	0	0
				max	Co #17	0.729	(521)	0.9	5.1	31.0	0.5	-22.6	3.7
			My	min	Co #17	0.729	(521)	0.9	-5.1	-31.0	-0.5	-22.6	3.7
				max	Co #7	0.729	(521)	6.3	0	0.3	0	0.2	0
			Mz	min	Co #16	0.729	(521)	0.2	5.1	-30.9	0.5	-22.6	-3.7
				max	Co #17	0.729	(521)	0.9	5.1	31.0	0.5	-22.6	3.7
548	13	HE 140 A			L=1.366								
			Nx	min	Co #2	0.683	(351)	0.2	0	0.1	0	-0.1	0
				max	Co #7	0.683	(351)	8.1	0	0.8	0	-0.6	0
			Tx	min	Co #17	0	(396)	1.1	-4.3	-30.9	-0.5	0	0
				max	Co #17	0.683	(351)	1.0	4.3	30.7	0.5	-21.0	2.9
			My	min	Co #17	0.683	(351)	1.1	-4.3	-30.7	-0.5	-21.0	2.9
				max	Co #12	0.683	(351)	0.5	0	0.2	0	0.1	0
			Mz	min	Co #16	0.683	(351)	0.7	4.3	-30.7	0.5	-21.0	-2.9
				max	Co #17	0.683	(351)	1.0	4.3	30.7	0.5	-21.0	2.9

Sh.: Cross-section; C: Extremal component; min, max.: Extreme type; Case: Load case of extreme; Loc.: Cross-section local x position on the beam; Nx: Axial force; Vy: Shear force in local y direction; Vz: Shear force in local z direction; Tx: Torsional moment; My: Flexural moment about local y axis; Mz: Flexural moment about local z axis;

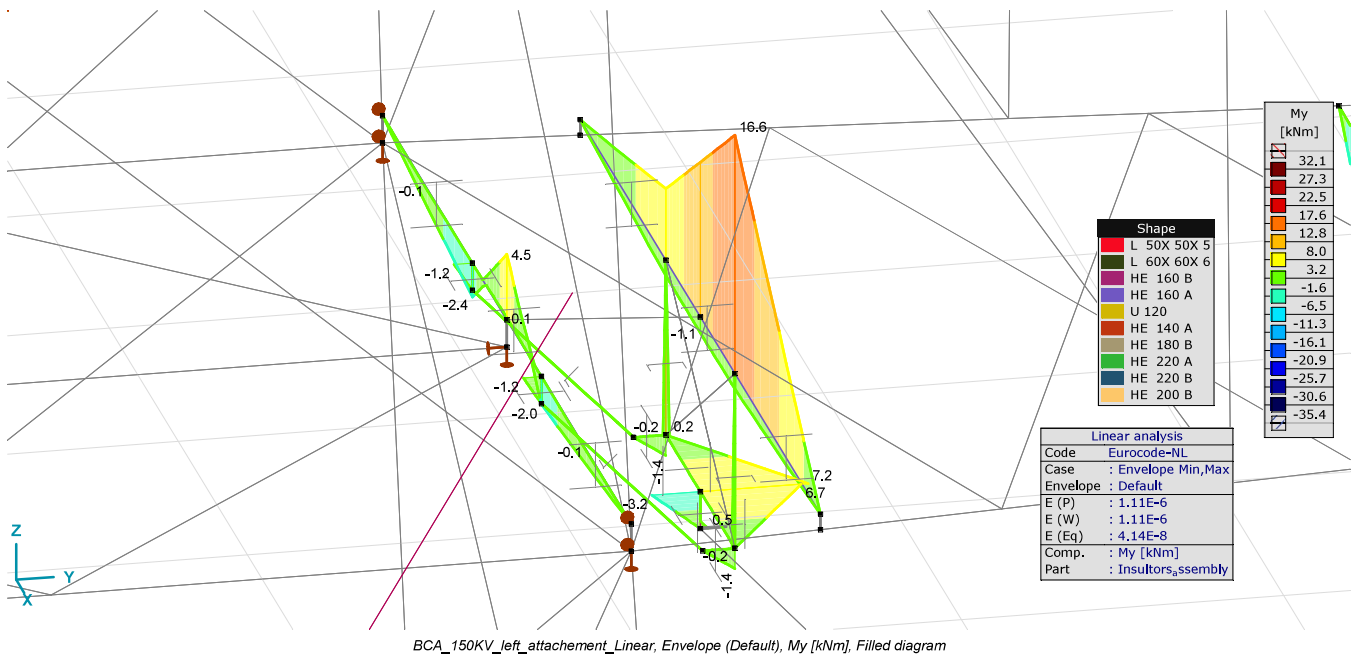

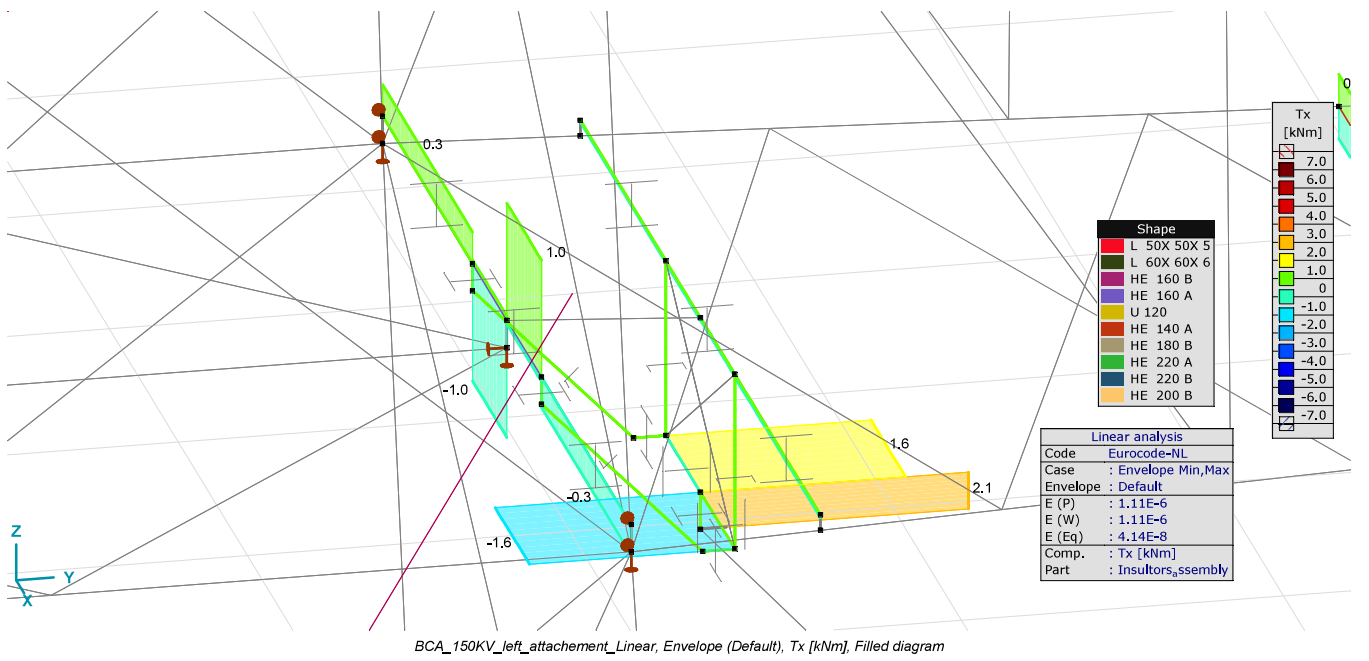
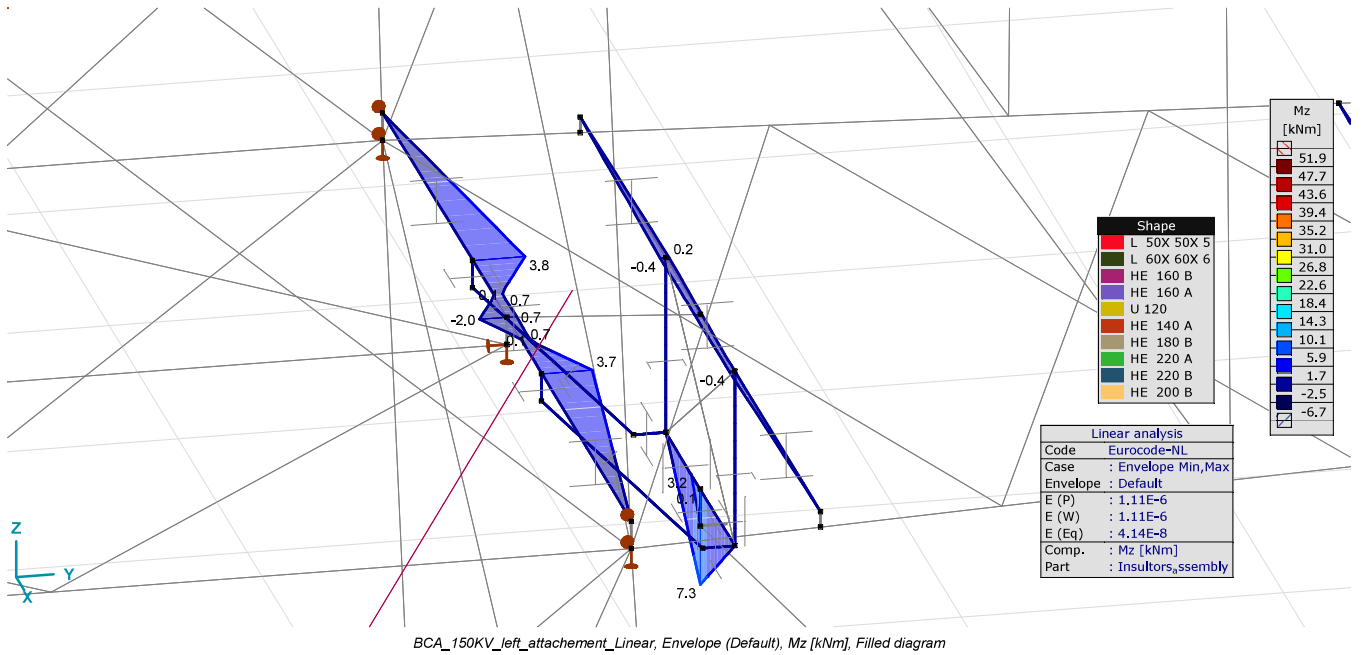

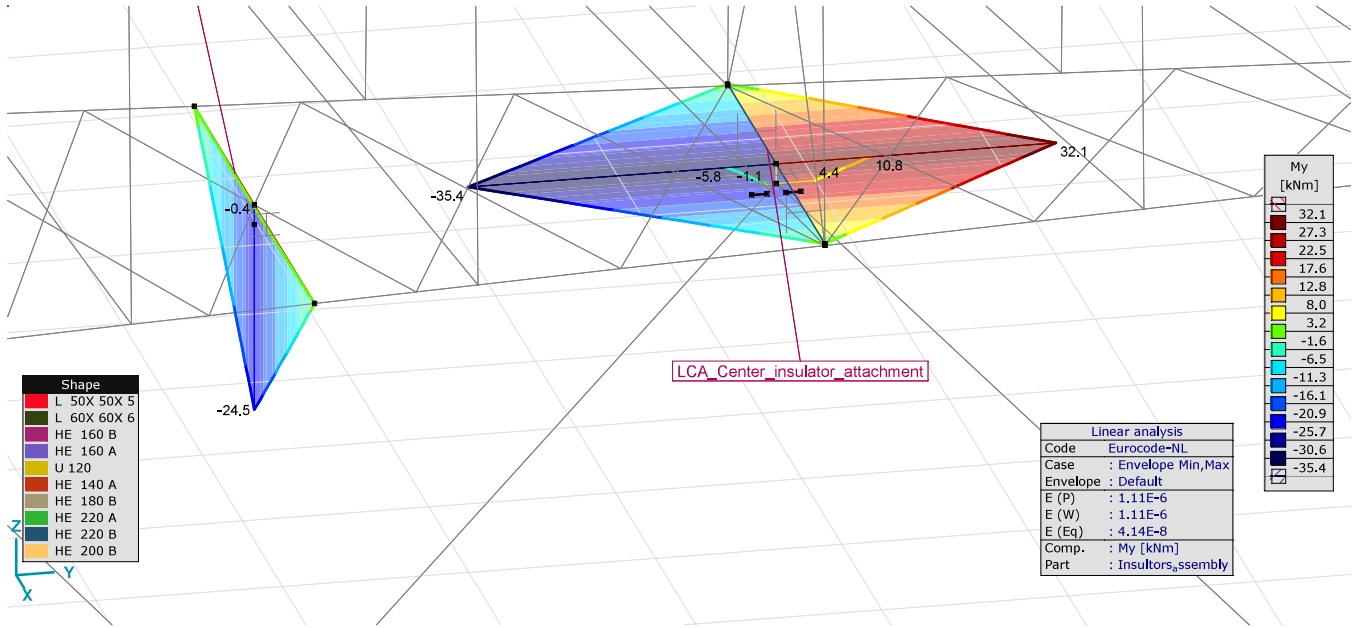

BCA_Center_insulator_attachment_Linear, Envelope (Default), My [kNm], Filled diagram

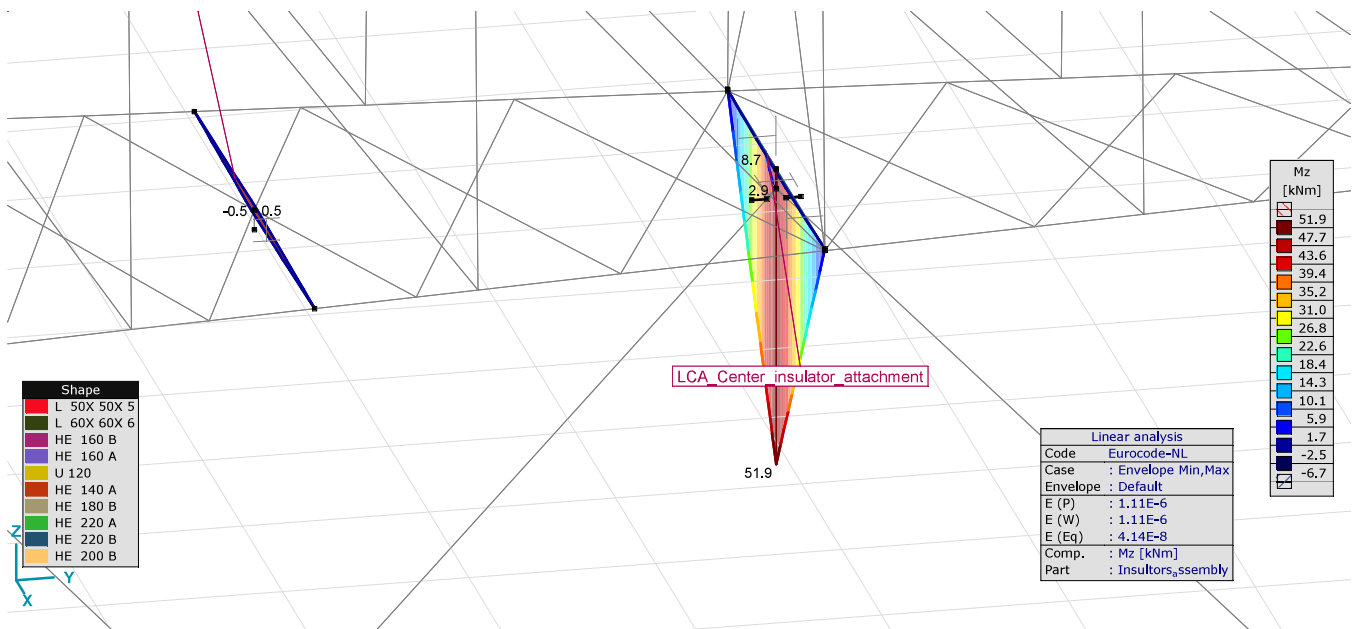

BCA_Center_insulator_attachment_Linear, Envelope (Default), Mz [kNm], Filled diagram

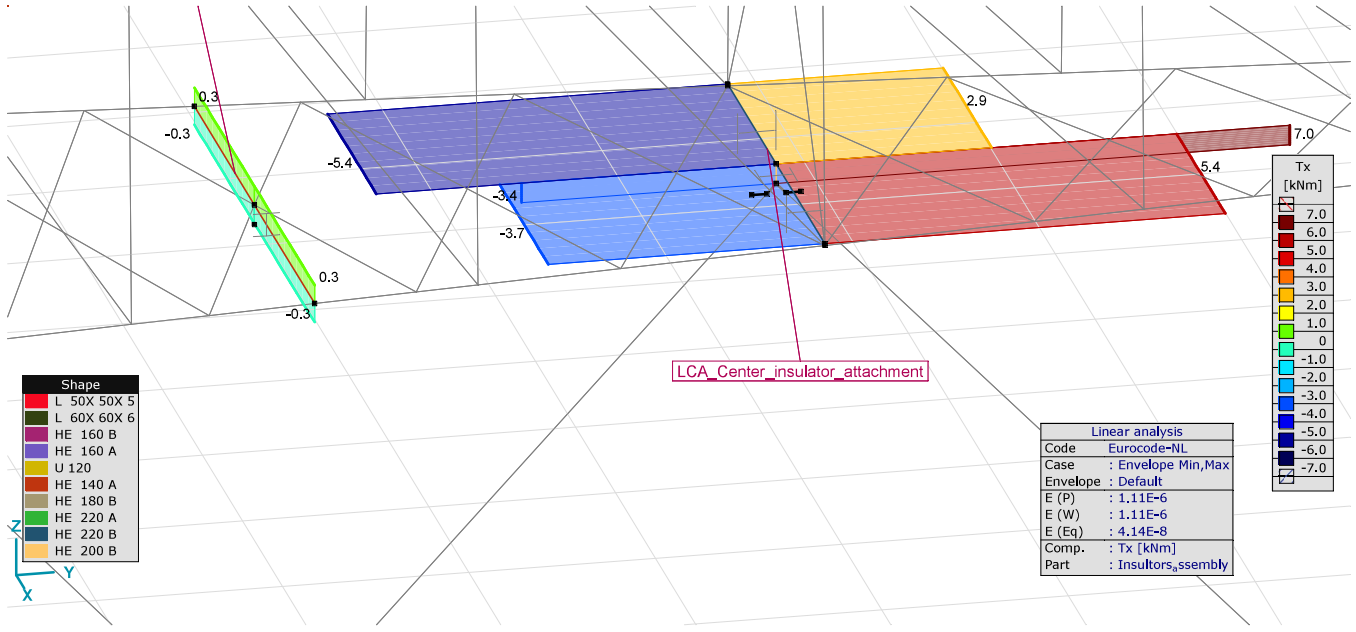

BCA_Center_insulator_attachment_Linear, Envelope (Default), Tx [kNm], Filled diagram

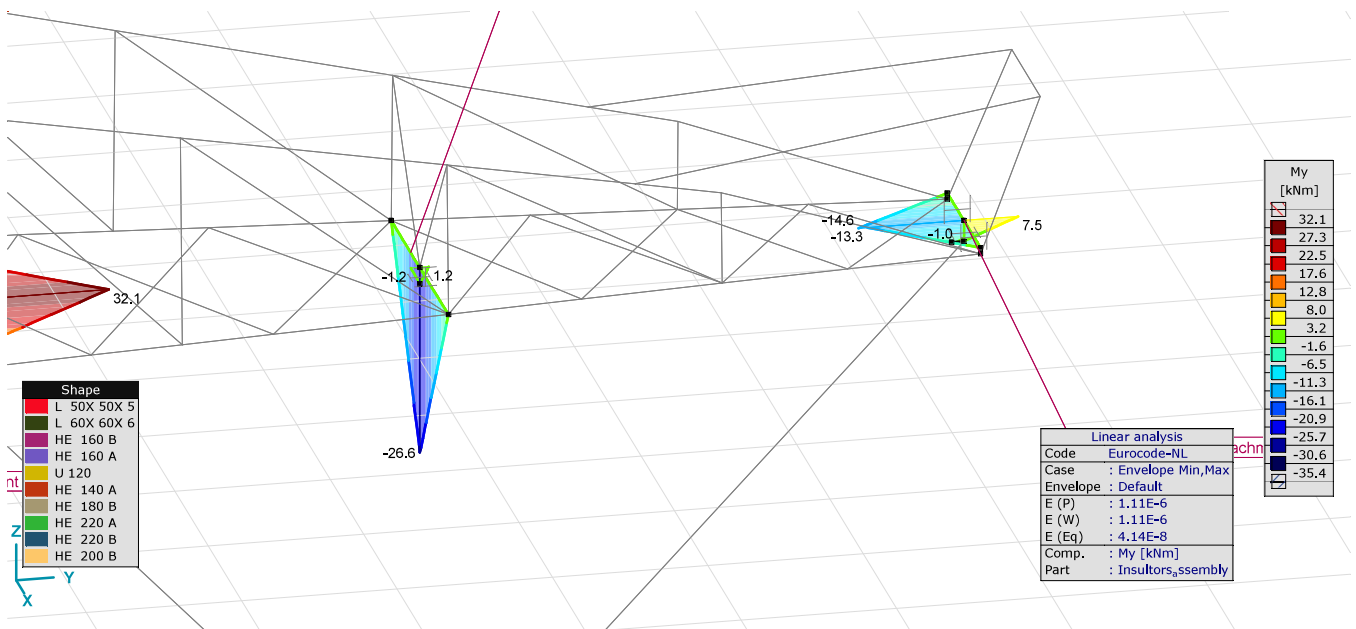

BCA_380KV_right_attachment_Linear, Envelope (Default), My [kNm], Filled diagram

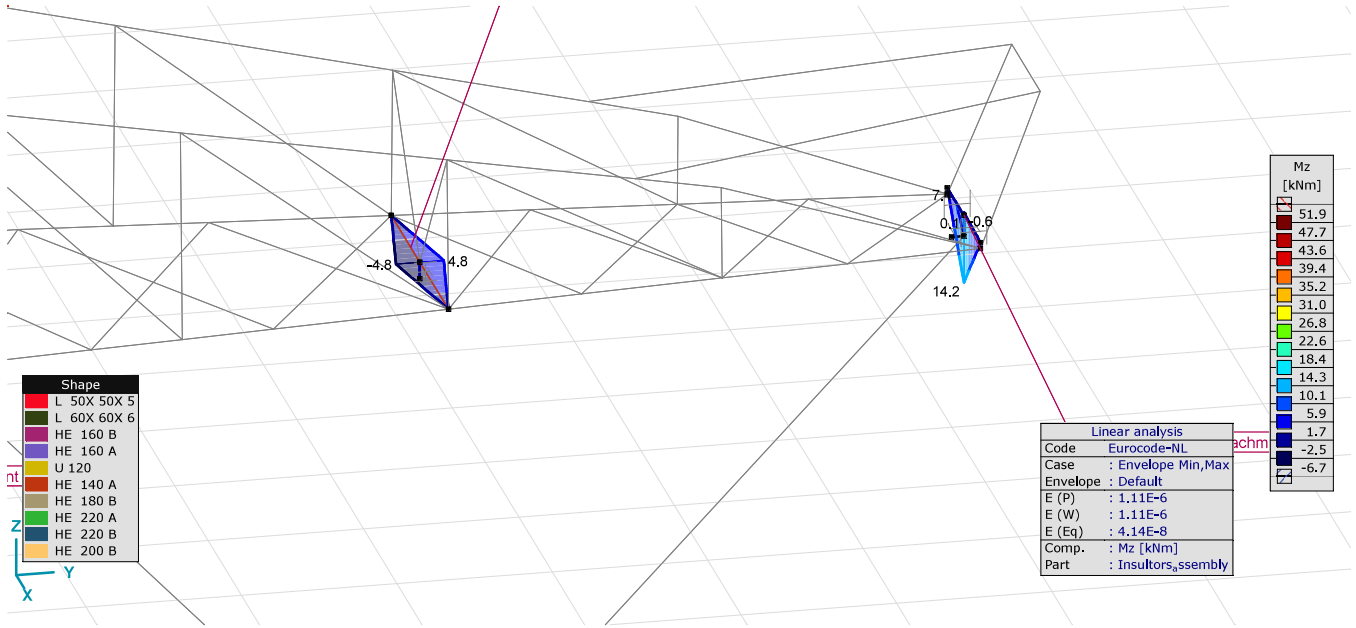

BCA_380KV_right_attachment_Linear, Envelope (Default), Mz [kNm], Filled diagram

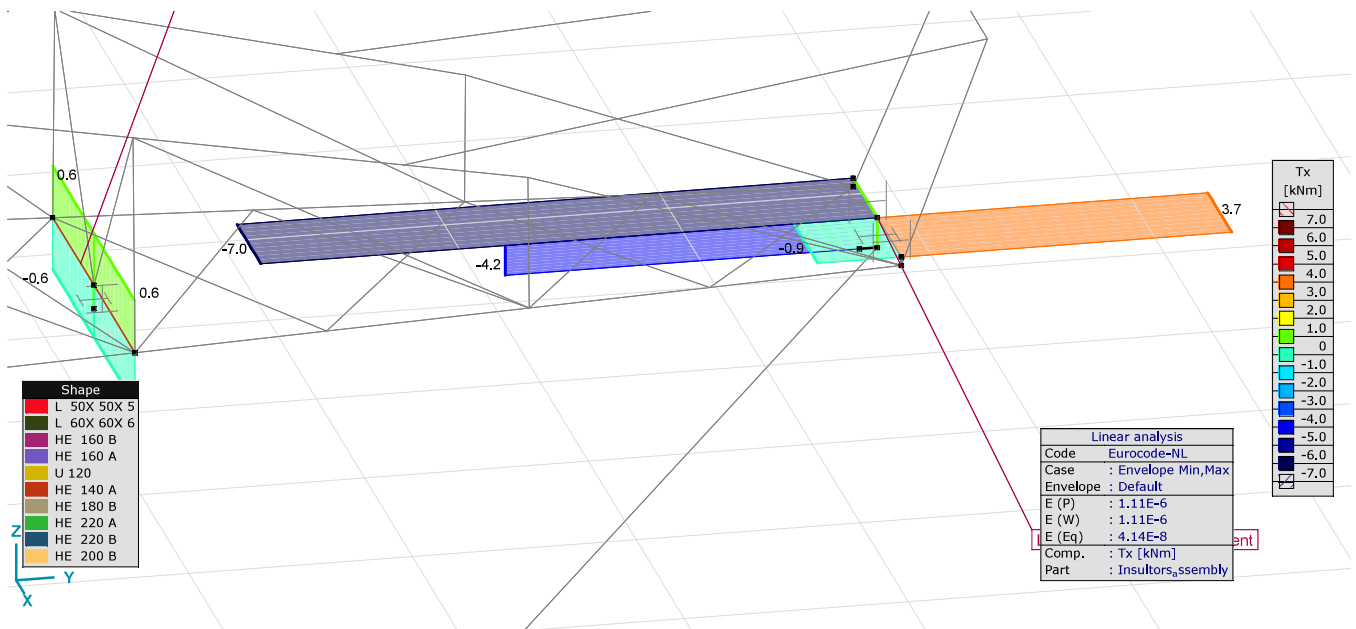

BCA_380KV_right_attachment_LLlinear, Envelope (Default), Tx [kNm], Filled diagram

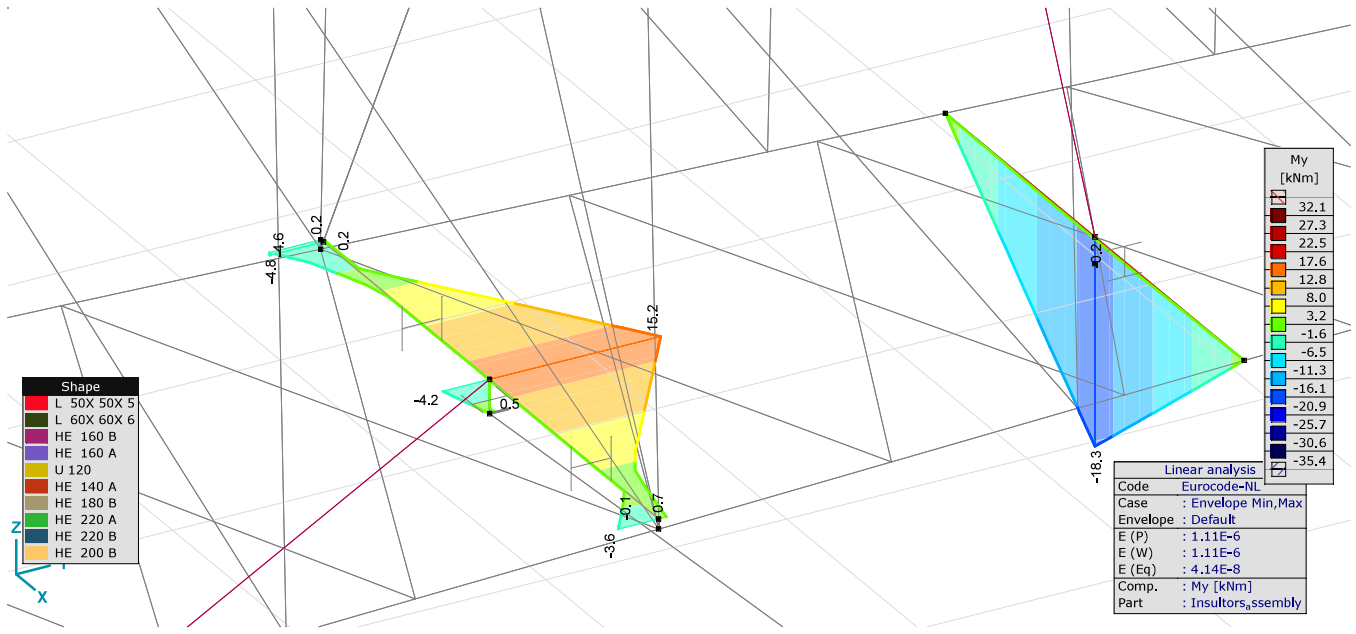

MCA_150_KV_left_attachment_Linear, Envelope (Default), My [kNm], Filled diagram

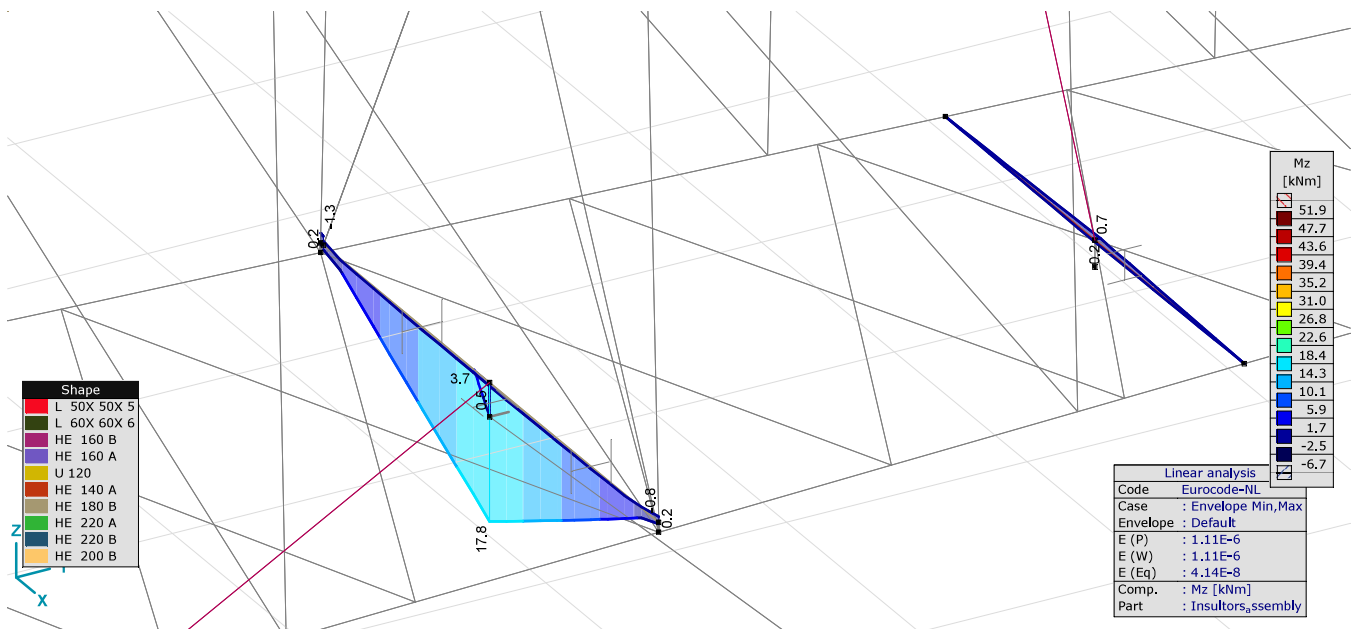

MCA_150_KV_left_attachment_Linear, Envelope (Default), Mz [kNm], Filled diagram

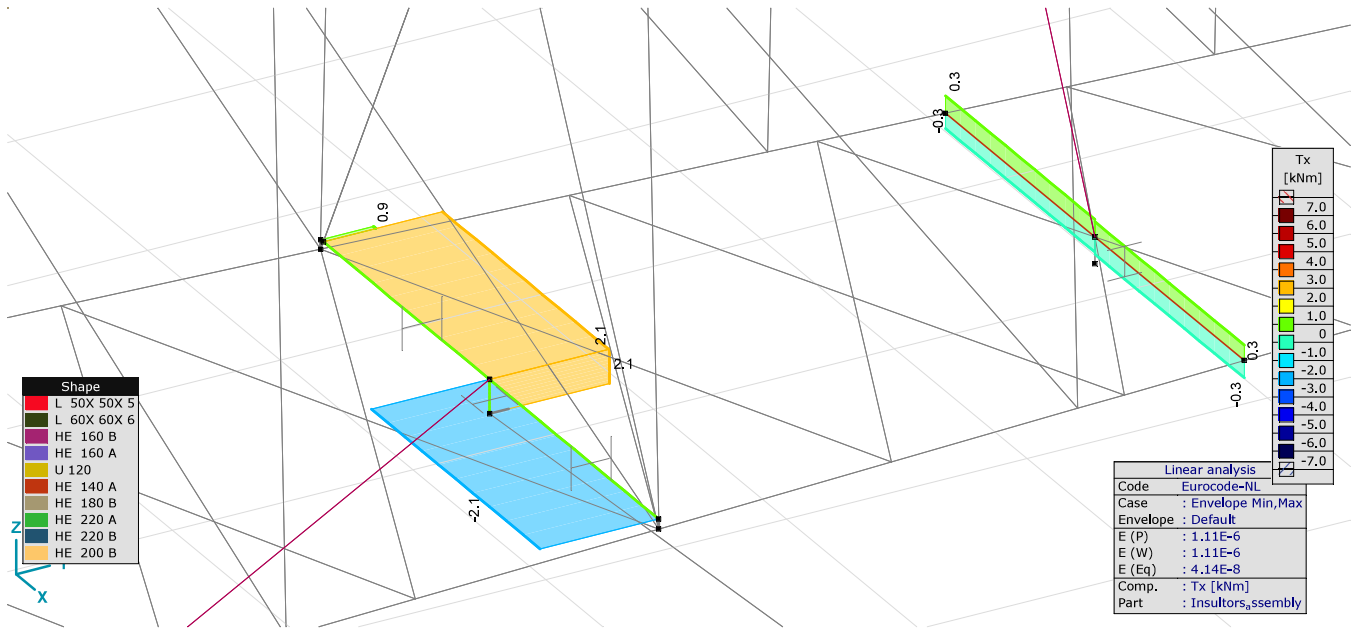

MCA_150_KV_left_attachment_Linear, Envelope (Default), Tx [kNm], Filled diagram

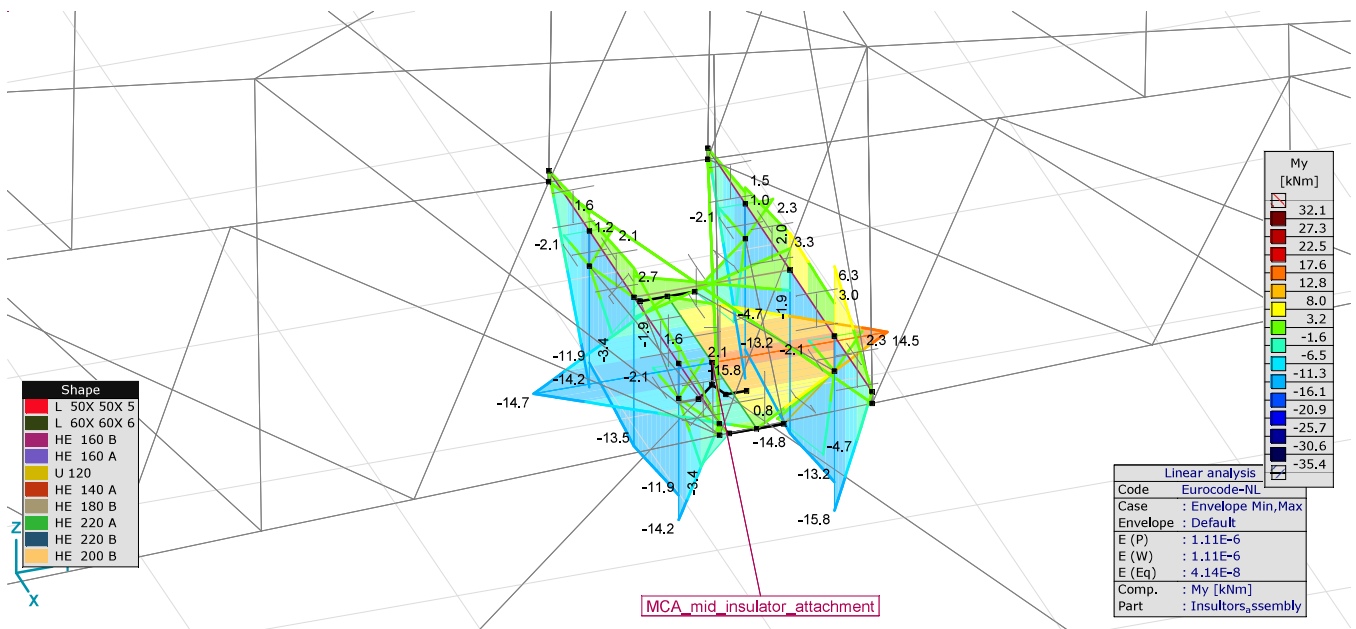

MCA_mid_insulator_attachment

MCA_mid_insulator_attachment_Linear, Envelope (Default), My [kNm], Filled diagram

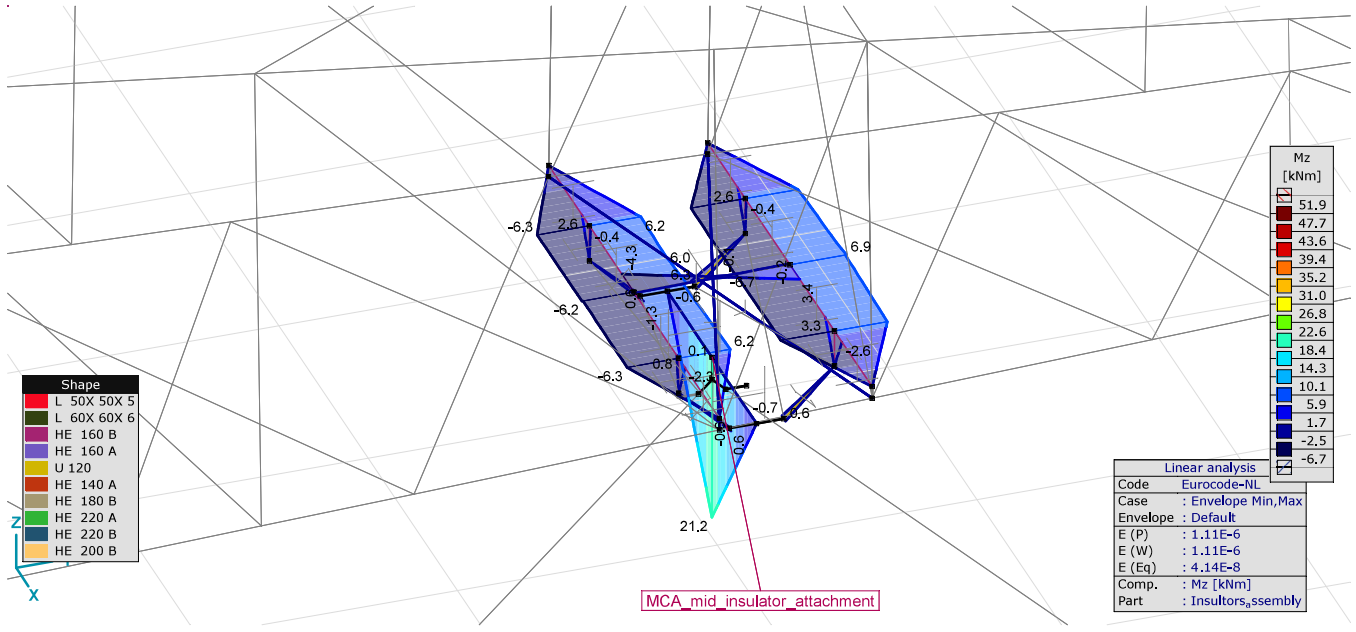

MCA_mid_insulator_attachment_Linear, Envelope (Default), Mz [kNm], Filled diagram

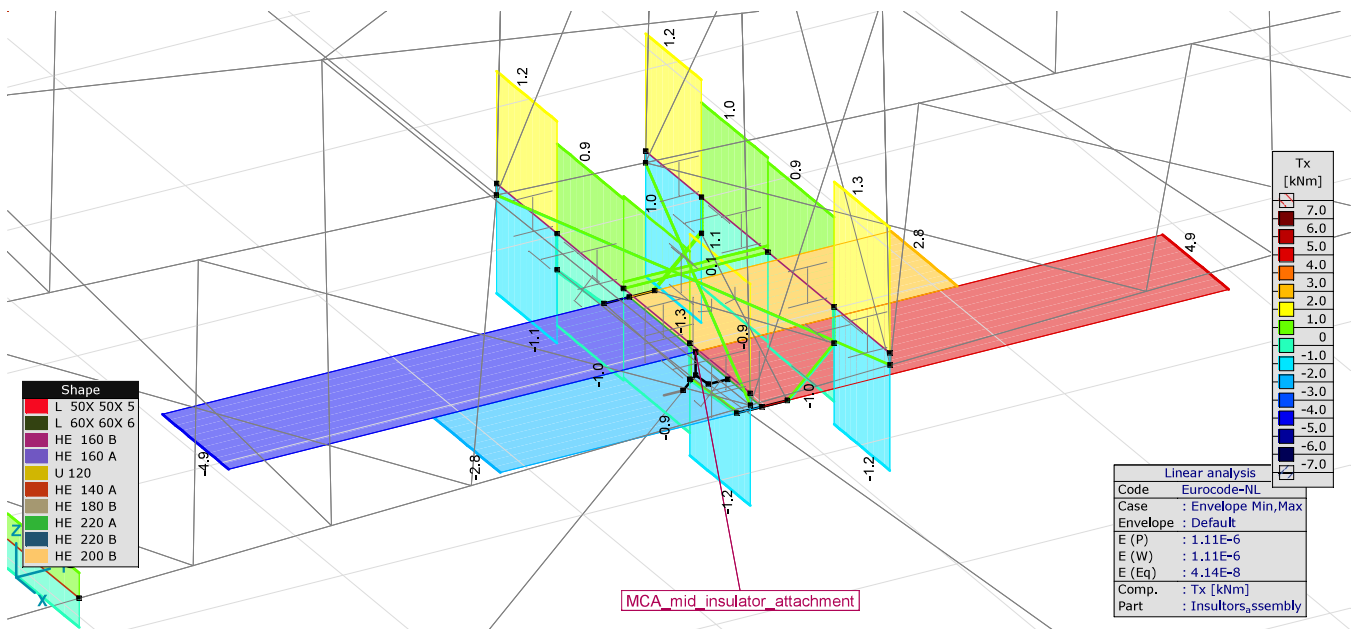

MCA_mid_insulator_attachment_Linear, Envelope (Default), Tx [kNm], Filled diagram

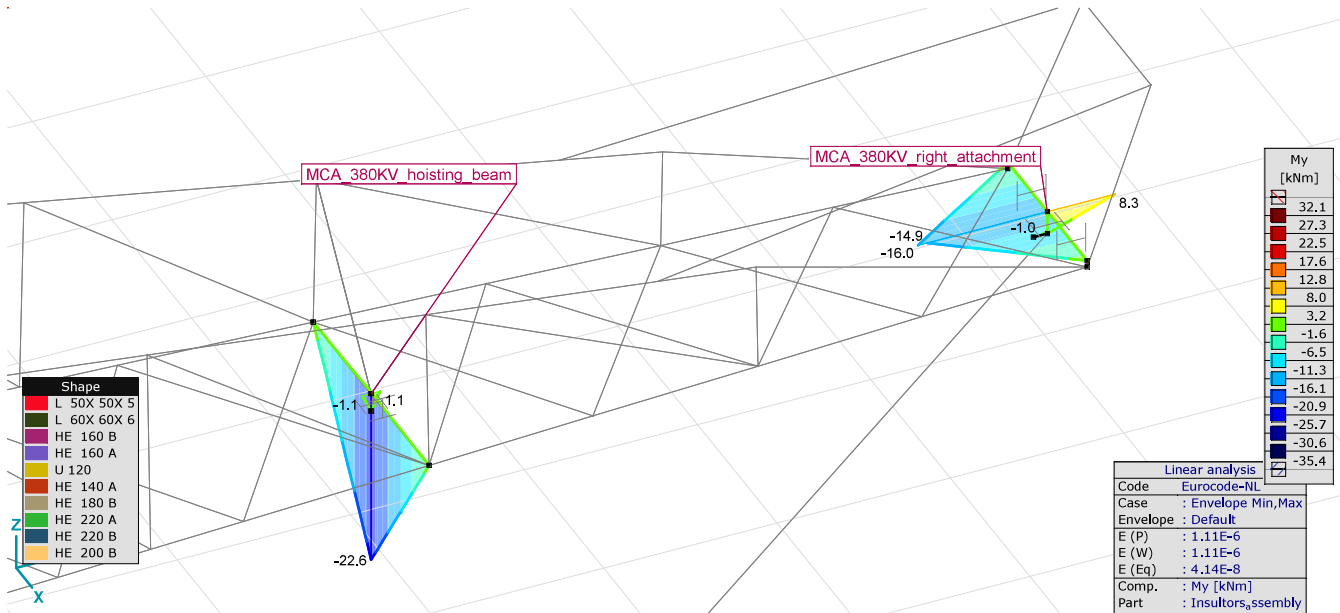

MCA_380KV_right_attachement_Linear, Envelope (Default), My [kNm], Filled diagram

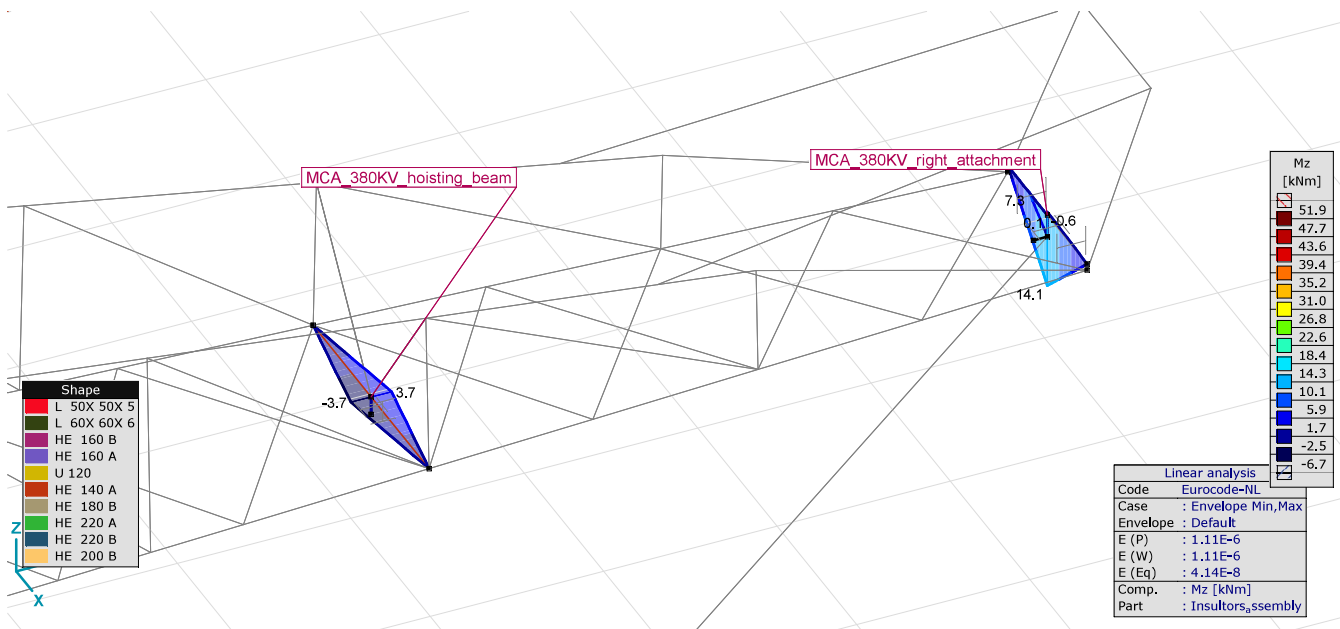

MCA_380KV_right_attachement_Linear, Envelope (Default), Mz [kNm], Filled diagram

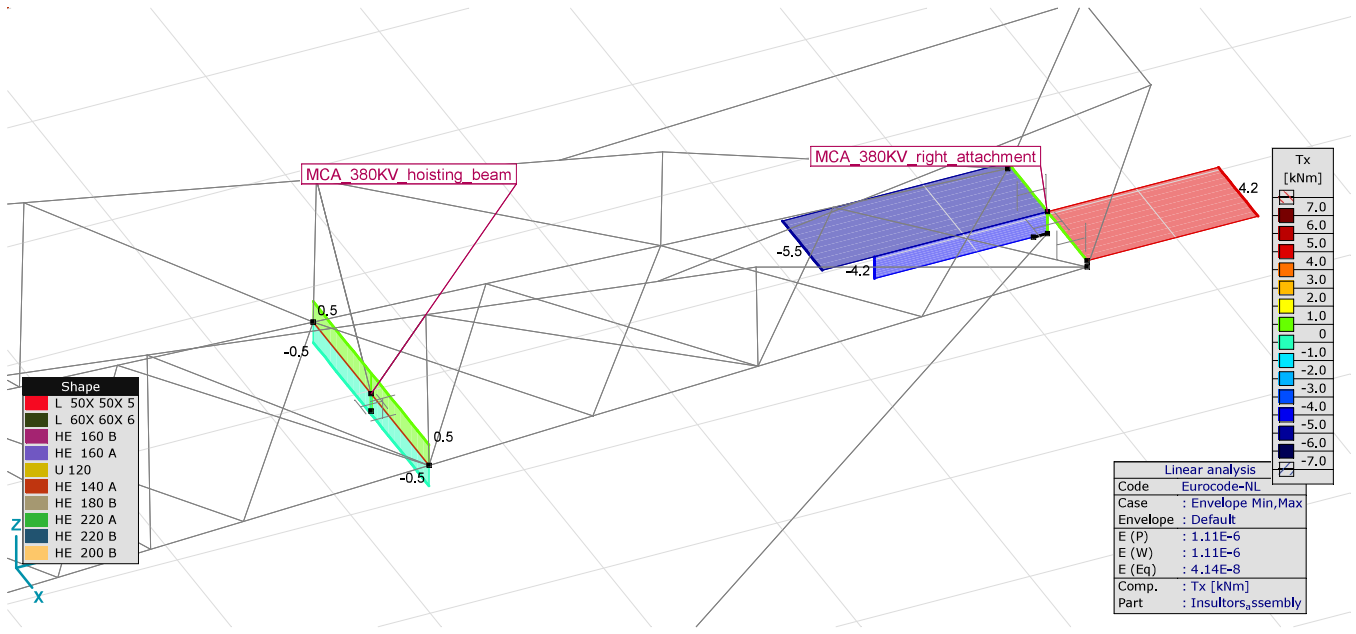

MCA_380KV_right_attachment_Linear, Envelope (Default), Tx [kNm], Filled diagram

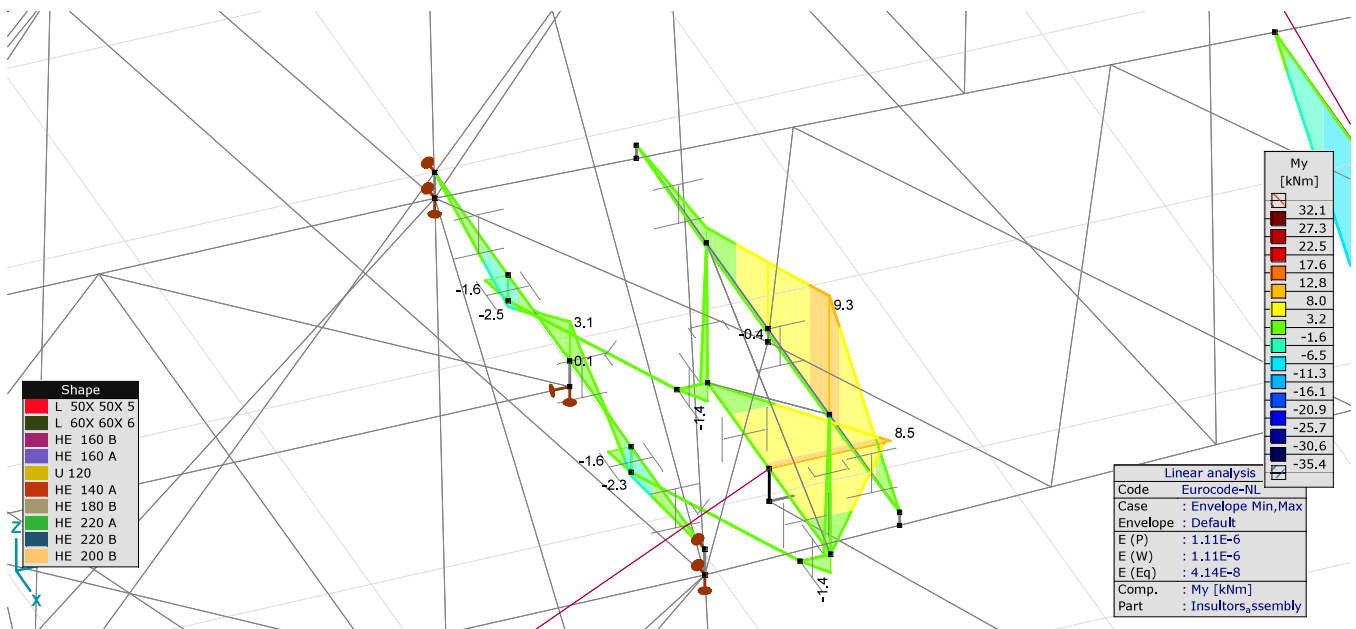

UCA_150KV_left_attachment_Linear, Envelope (Default), My [kNm], Filled diagram

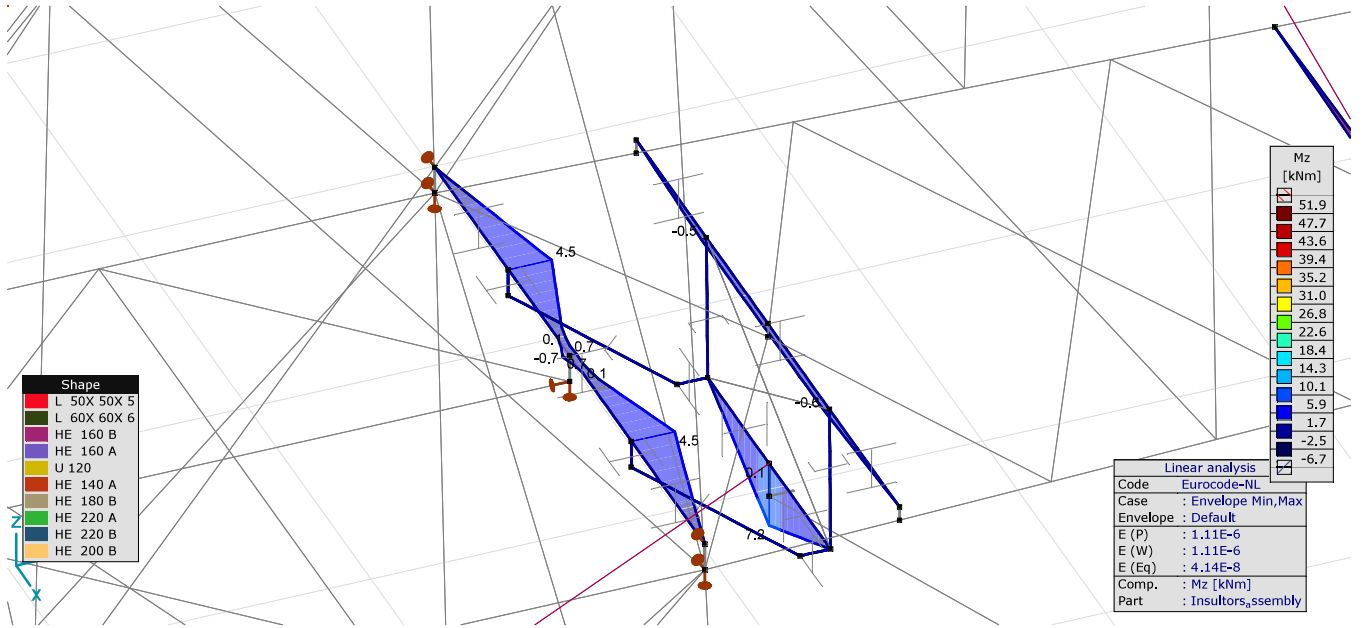

UCA_150KV_left_attachment_Linear, Envelope (Default), Mz [kNm], Filled diagram

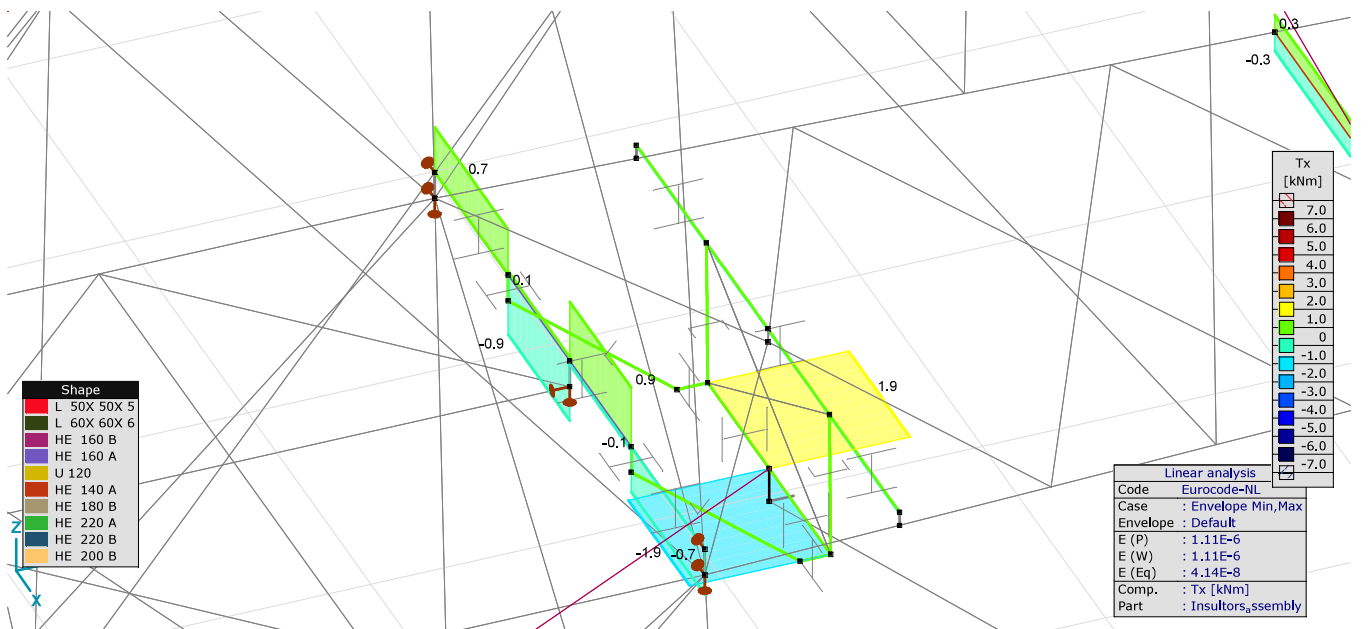

UCA_150KV_left_attachment_Linear, Envelope (Default), Tx [kNm], Filled diagram

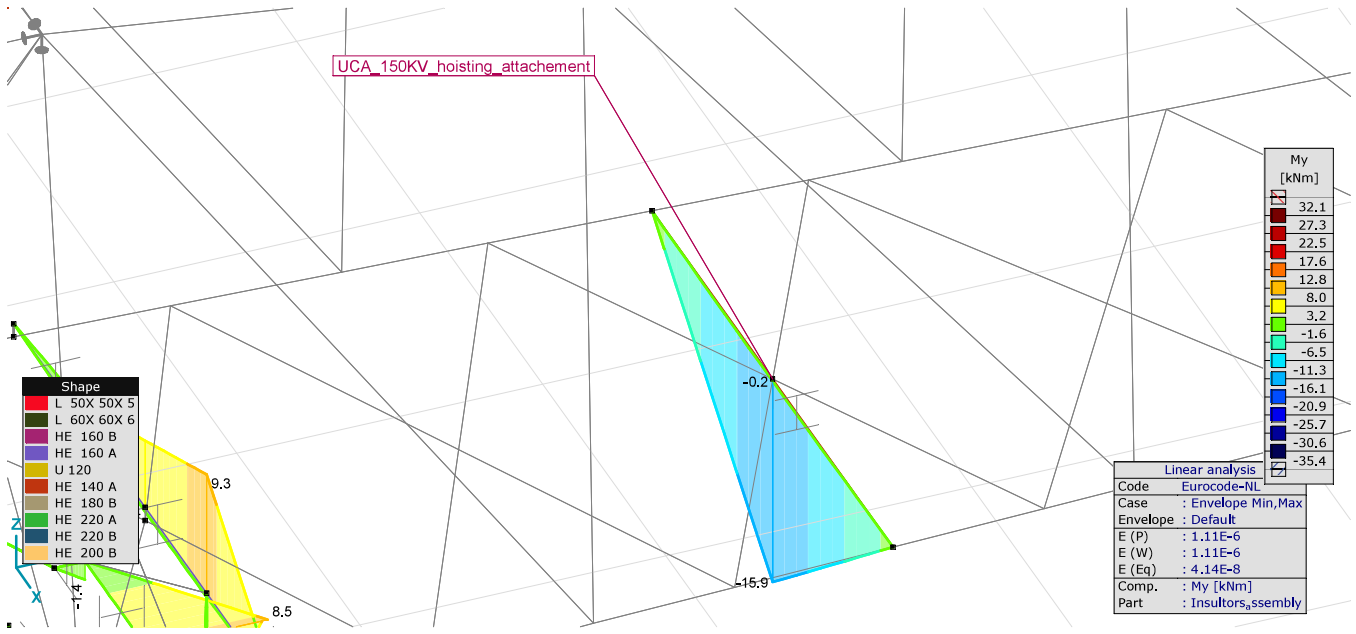

UCA_150KV_hoisting_attachment_Linear, Envelope (Default), My [kNm], Filled diagram

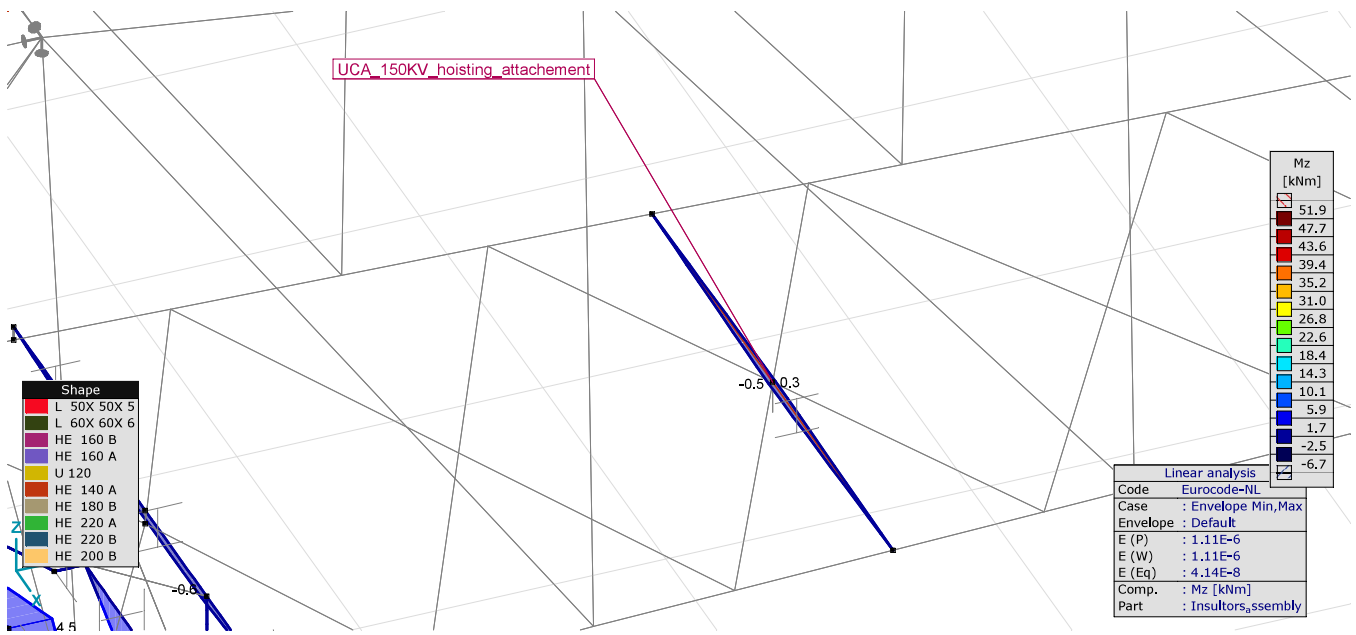

UCA_150KV_hoisting_attachment_Linear, Envelope (Default), Mz [kNm], Filled diagram

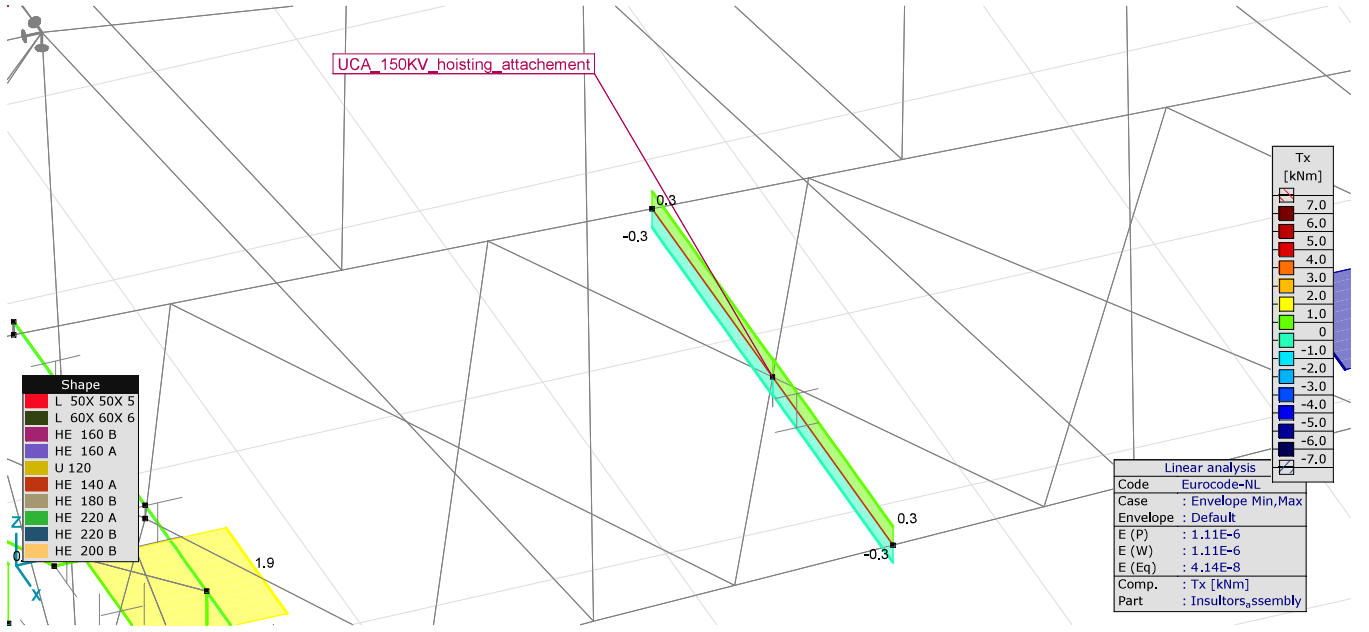

UCA_150KV_hoisting_attachment_Linear, Envelope (Default), Tx [kNm], Filled diagram

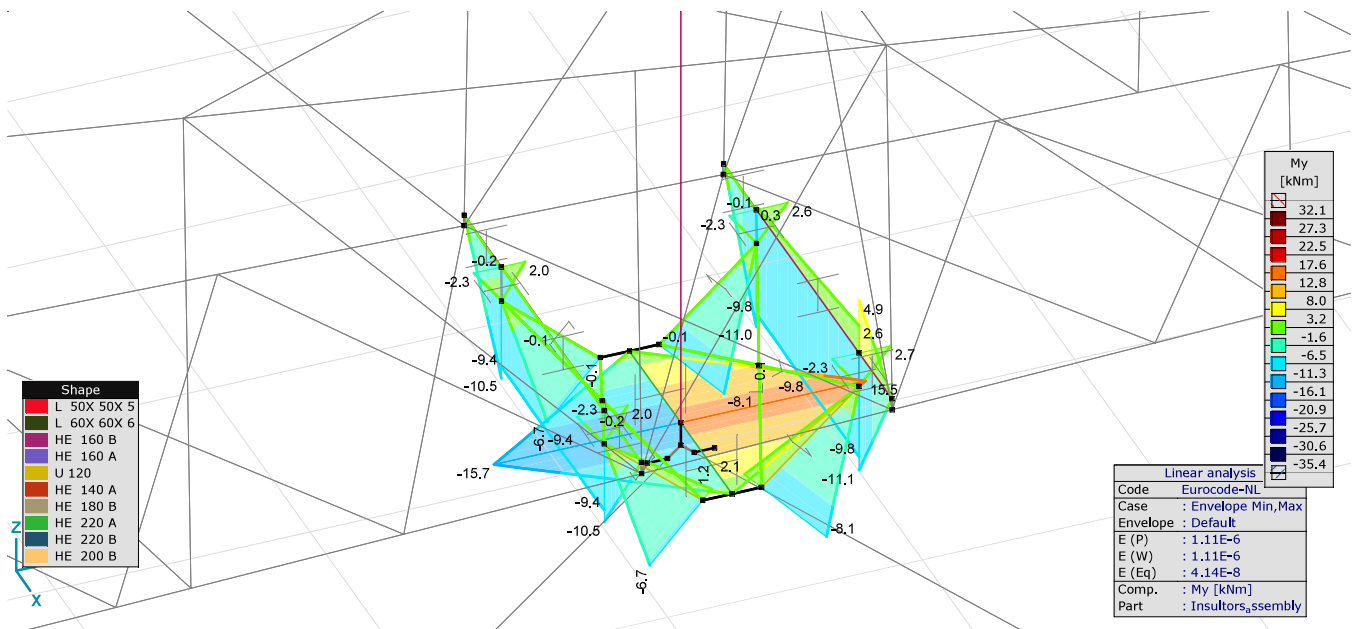

UCA_mid_insulator_attachment_Linear, Envelope (Default), My [kNm], Filled diagram

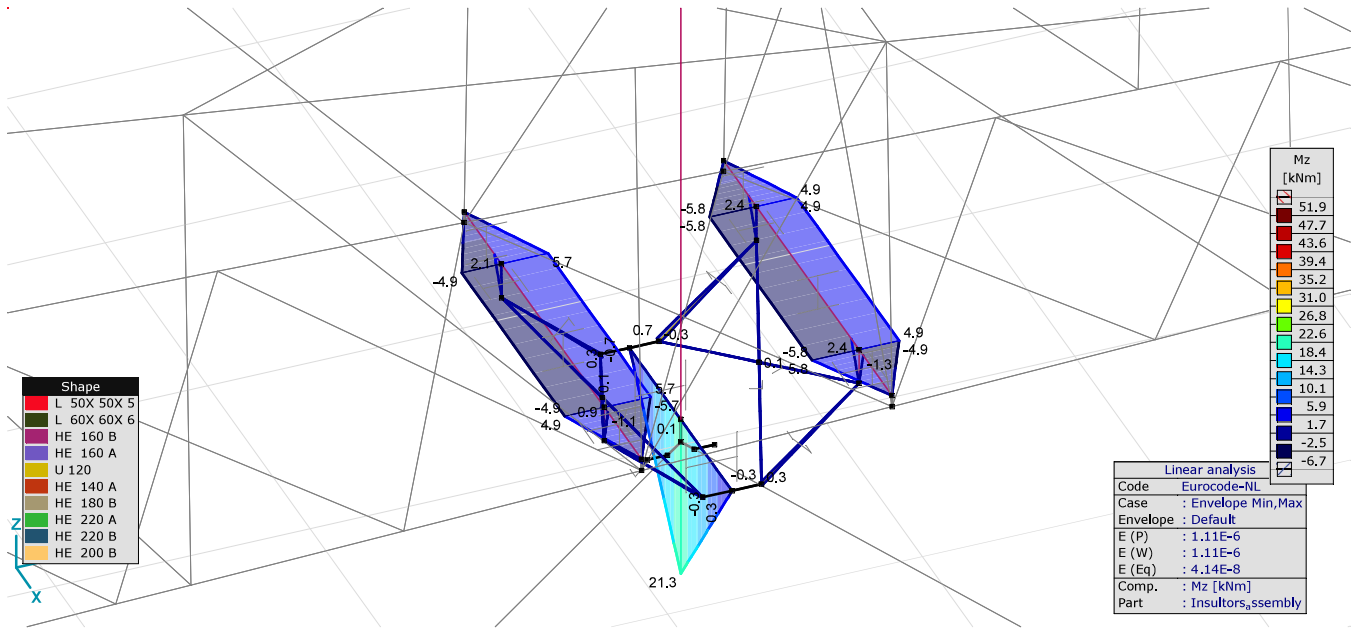

UCA_mid_insulator_attachment_Linear, Envelope (Default), Mz [kNm], Filled diagram

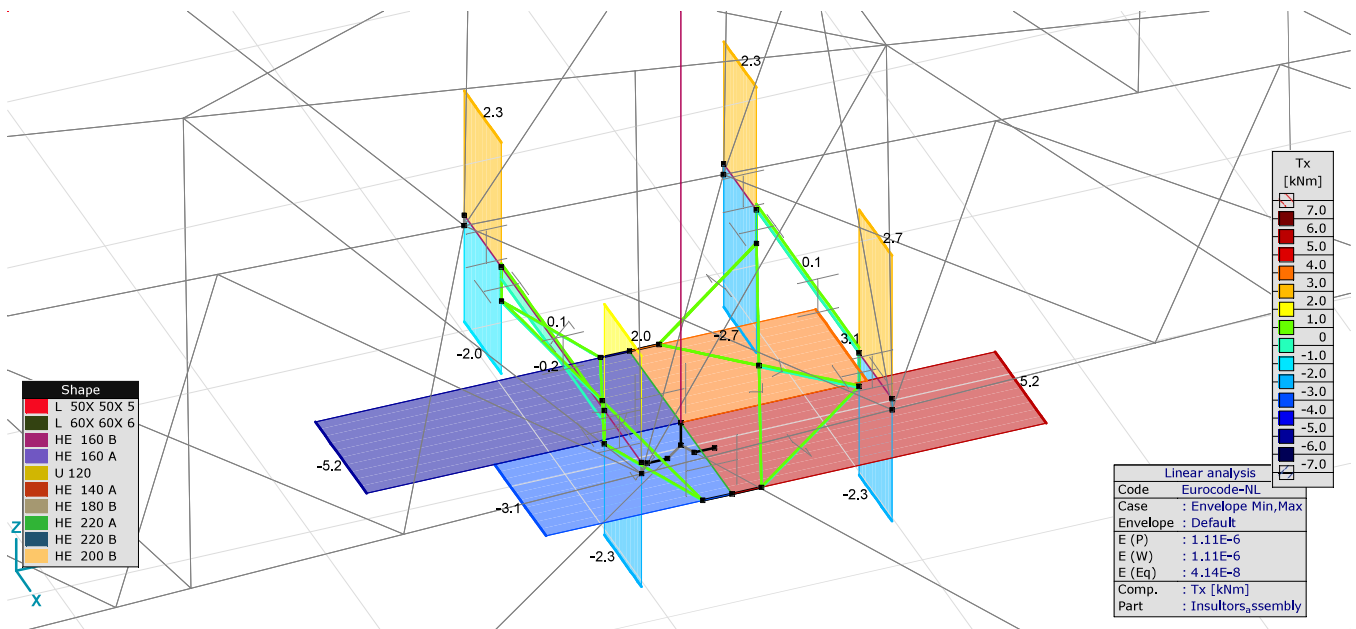

UCA_mid_insulator_attachment_Linear, Envelope (Default), Tx [kNm], Filled diagram

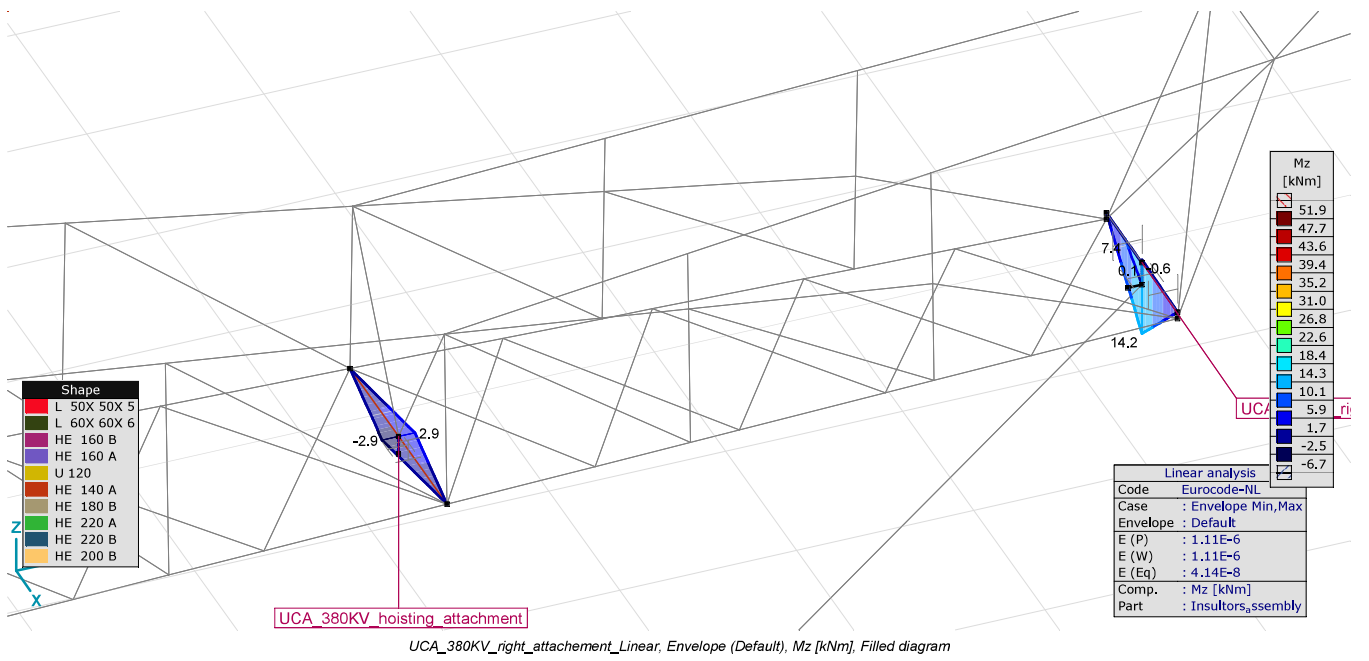
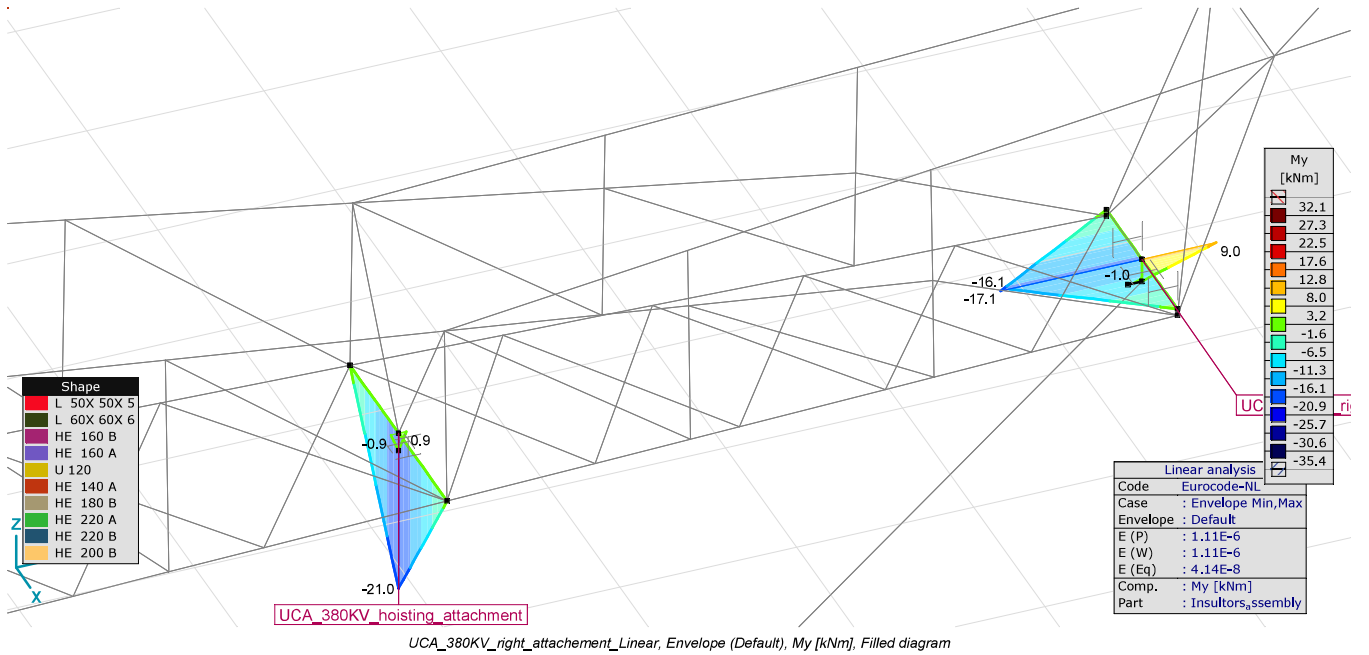

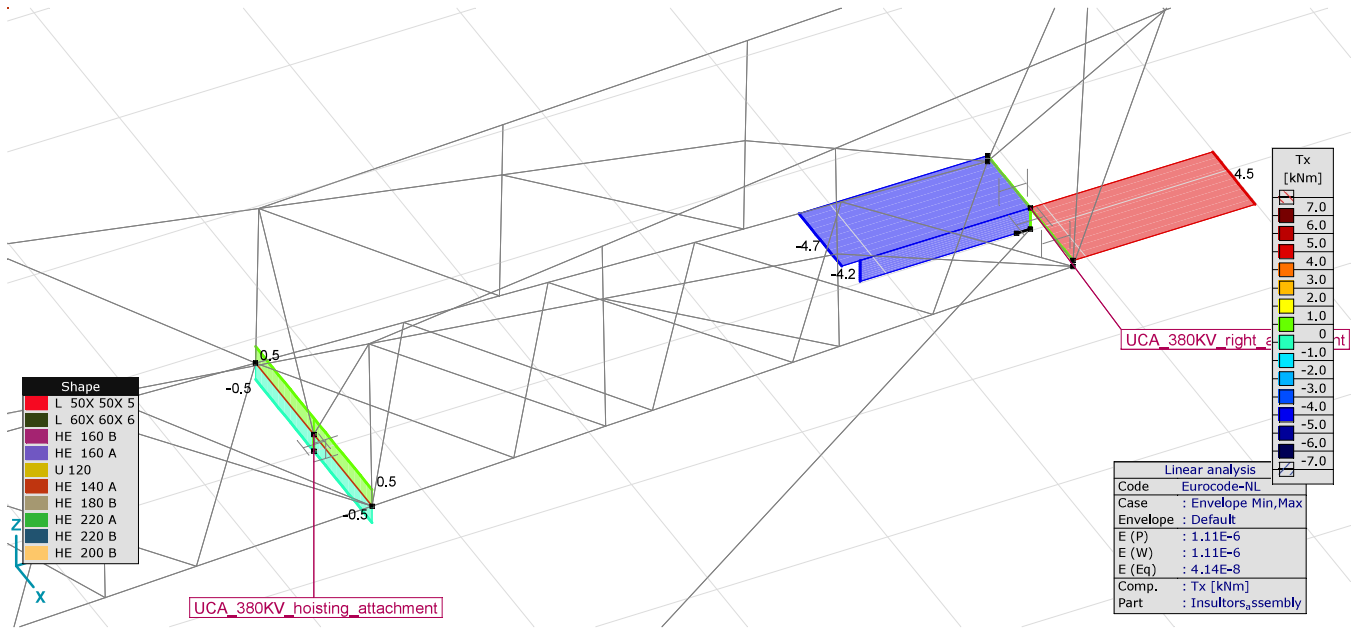

APPENDIX F

Sterkte-coördinatie

In 5.5.1 van het uitgangspuntenrapport is beschreven dat aan sterkte-coördinatie wordt voldaan als de U.C. van de staven in de traverse 10 procentpunt groter is dan de U.C. van de staven in het mastlichaam. Uitgangspunt is belastingcombinatie 5a, geleiderbreuk. In deze Appendix wordt getoetst of de U.C. van de staven in het mastlichaam voldoende laag is ten opzichte van de U.C. van de staven in de traverse.

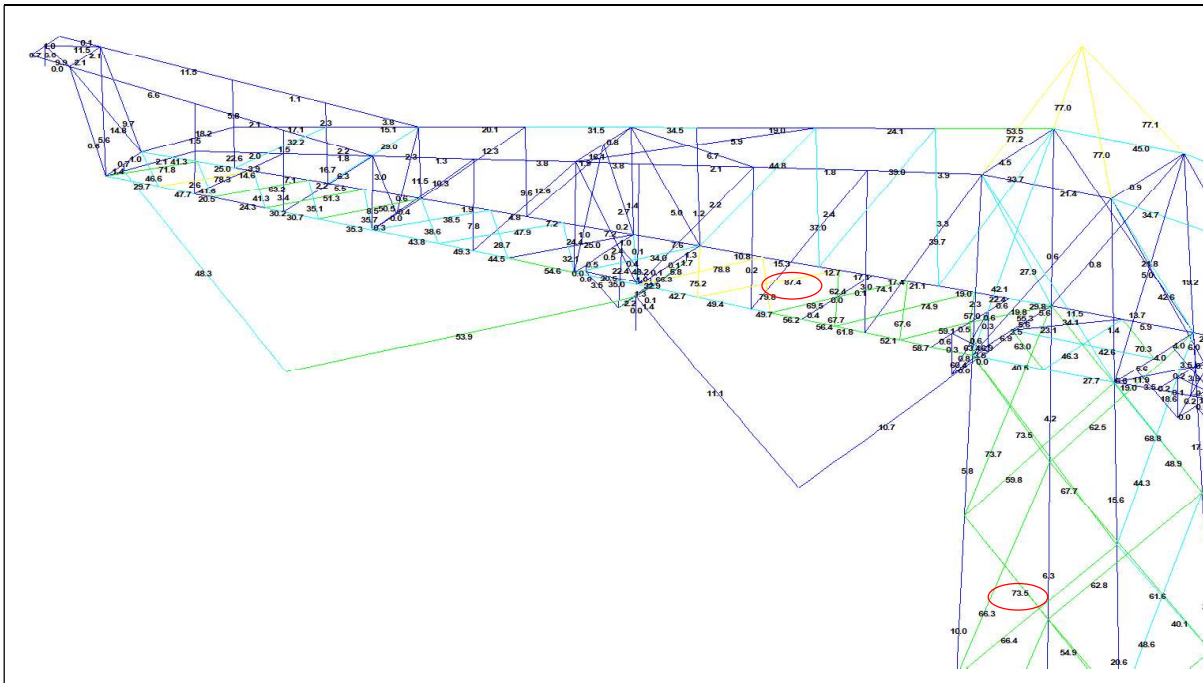

Boventraverse – diagonalen bovenstuk 2: $87,4 / 73,5 = 1,18 \geq 1,10$ OK.

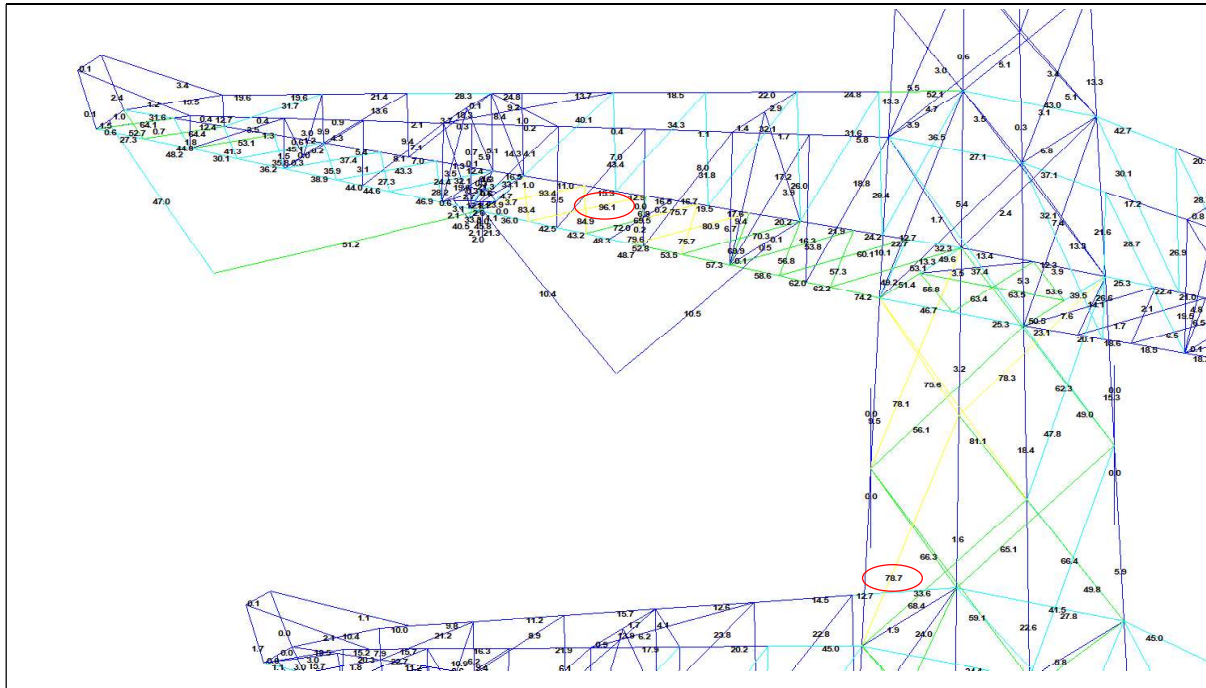

Middentraverse – diagonalen bovenstuk: $96,1 / 78,7 = 1,22 \geq 1,10$ OK.

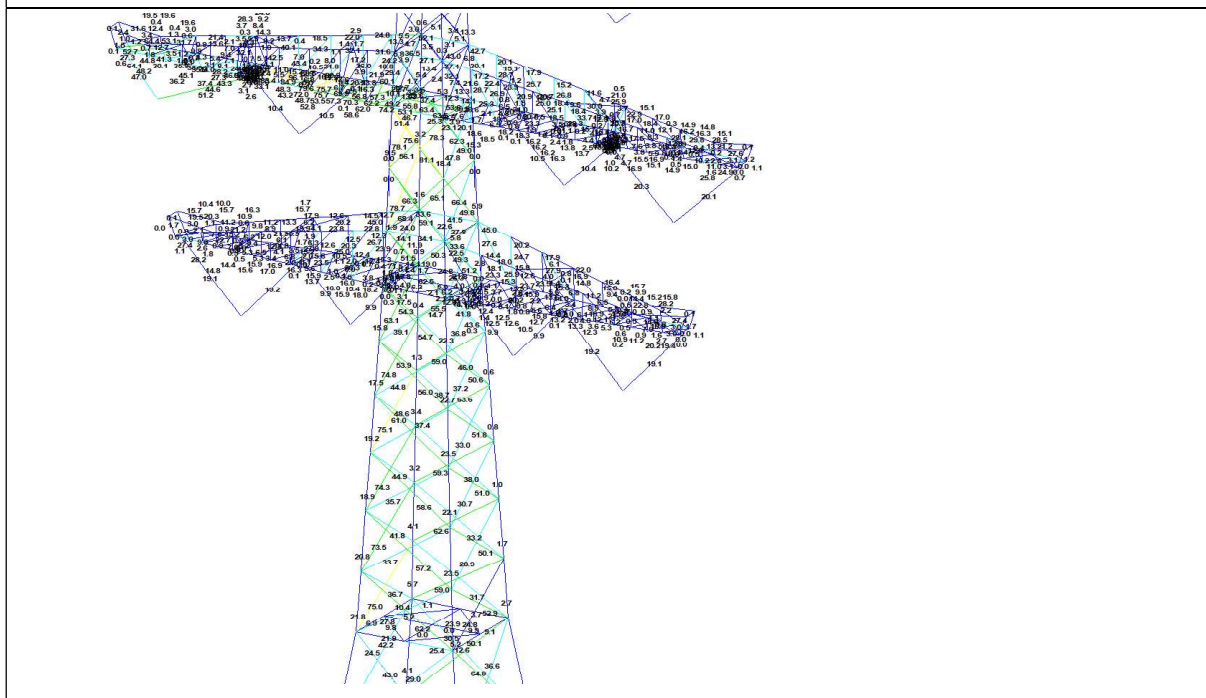

Middentraverse – diagonalen onderstuk: $96,1 / 75,0 = 1,28 \geq 1,10$ OK.

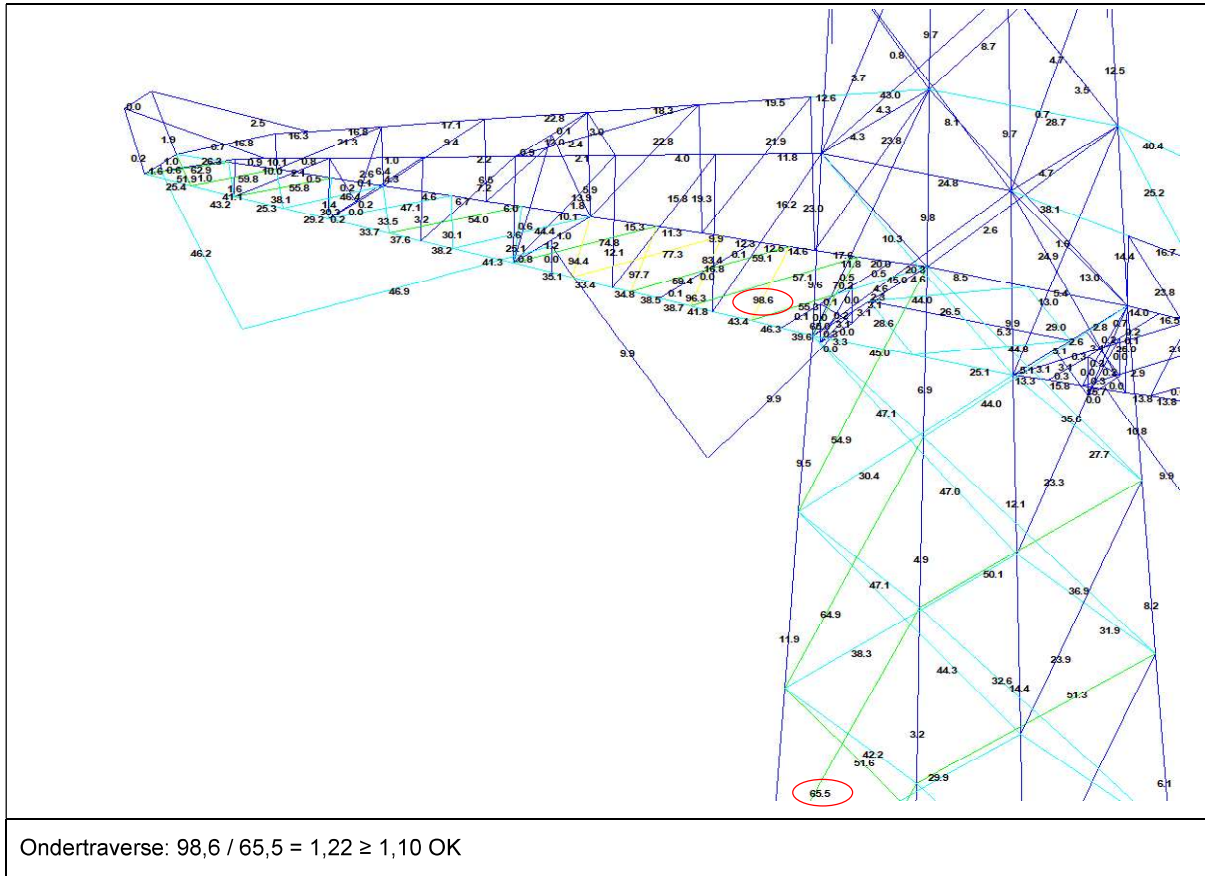



About DNV

DNV is the independent expert in risk management and assurance, operating in more than 100 countries. Through its broad experience and deep expertise DNV advances safety and sustainable performance, sets industry benchmarks, and inspires and invents solutions.

Whether assessing a new ship design, optimizing the performance of a wind farm, analyzing sensor data from a gas pipeline or certifying a food company's supply chain, DNV enables its customers and their stakeholders to make critical decisions with confidence.

Driven by its purpose, to safeguard life, property, and the environment, DNV helps tackle the challenges and global transformations facing its customers and the world today and is a trusted voice for many of the world's most successful and forward-thinking companies.

B.3 002.678.00 0928551 Mastrapportage HA_c

ZUID-WEST 380 KV OOST VERBINDINGEN

Mastrapport combi-hoekmasten HA/c

TenneT TSO B.V.

Meridian doc.nr.: 002.678.00 0928551

Rapport nr.: 21-0773, Rev. 1

Datum: 2021-07-19

DATUM:	30-09-2021
STATUS TENNET:	DEFINITIEF
REVISIE TENNET:	1.0





Projectnaam: Zuid-West 380 kV Oost Verbindingen
Rapport titel: Mastrapport combi-hoekmasten HA/c
Klant: TenneT TSO B.V.,
Contactpersoon klant: XXXXXXXXXX
Datum uitgave: 2021-07-19
Project nr.: 10124719
Organisatie unit: TDT
Meridian doc.nr.: 002.678.00 0928551
Rapport nr.: 21-0773, Rev. 1

Energy Systems
DNV Netherlands B.V.
Utrechtseweg 310-B50
6812 AR Arnhem

Tel: 026 356 9111
Handelsregister Arnhem 09006404

Geschreven door: XXXXXXXXXX Beoordeeld door: XXXXXXXXXX Goedgekeurd door: XXXXXXXXXX

Copyright © DNV 2021. All rights reserved. Unless otherwise agreed in writing: (i) This publication or parts thereof may not be copied, reproduced or transmitted in any form, or by any means, whether digitally or otherwise; (ii) The content of this publication shall be kept confidential by the customer; (iii) No third party may rely on its contents; and (iv) DNV undertakes no duty of care toward any third party. Reference to part of this publication which may lead to misinterpretation is prohibited.

DNV Distributie:

- Open
- Intern
- Commercieel vertrouwelijk
- Vertrouwelijk
- Geheim

*Specificatie distributie: --

Trefwoorden:

Rev.	Datum	Reden van uitgave	Auteur	Beoordelaar	Goedkeuder
0	2021-05-18	Eerste uitgave	XXXXXXXXXX	XXXXXXXXXX	XXXXXXXXXX
0	2021-07-21	RFA-commentaar verwerkt	XXXXXXXXXX	XXXXXXXXXX	XXXXXXXXXX

Inhoudsopgave

1	INLEIDING	1
2	UITGANGSPUNTEN EN RANDVOORWAARDEN	2
2.1	Normen	2
2.2	TenneT-specificaties	2
2.3	Eisenverificatie	2
2.4	Ontwerprapporten	2
2.5	Materialen	2
2.6	Software	3
3	MASTONTWERP	4
3.1	Mastbeelden	4
3.2	Uitgangspunten berekening	8
3.3	Mastenlijst	8
3.4	Geleiderbelastingen	9
3.5	Reacties op de fundering	9
3.6	Modellering	9
3.7	Overige controles	9
3.8	Mastgewicht	9
4	TOETSING	10
4.1	Resultaat PLS-TOWER	10
4.2	Toetsing overige onderdelen	13
Appendix A	Geleiderbelastingen	
Appendix B	Resultaten PLS tower	
Appendix C	Knikverkorters	
Appendix D	Blokdeuvels	
Appendix E	Liggers	
Appendix F	Sterkte-coördinatie	
Appendix G	Galloping	

1 INLEIDING

In het basisontwerp van de vakwerkmasten voor de verbinding RLL-TLB380 in het project Zuid-West 380 kV-Oost zijn voor het vaststellen van de haalbaarheid constructieve berekeningen uitgevoerd aan de masten en fundaties. In de Definitief Ontwerpfase, moeten berekeningen verder worden uitgewerkt om te kunnen dienen voor de benodigde vergunningsdocumentatie, voor de aanbesteding en als voorbereiding voor de uitvoeringsfase. Het DO omvat het ontwerp van de mastconstructies, de fundaties en de opstijpunten in de verbinding.

Deze rapportage bevat de resultaten van de toetsing van alle masttypen binnen de groep van combi-hoekmasten type HA, een masttype geschikt voor 2 circuits 150 kV en 380 kV en geschikt voor lijnhoeken van 180° tot 160°. Het ontwerp van de combi-hoekmasten HA+0/c t/m HA+6/c is zodanig dat de "mastkop" gedeeld wordt binnen de groep van de combi-HA-hoekmasten, alleen de hoogte van het onderstuk verschilt

In deze rapportage is de toetsing van de mastkop van de combi-HA-hoekmasten en de toetsing van alle onderstukken van de verschillende typen opgenomen. De toetsing bestaat uit controle van:

- de profielen en boutverbindingen onderdeel van de hoofd draagconstructie
- de knikverkorters
- de liggers voor de isolator kettingen
- de verbinding met de fundatie via blokdeuvels
- aanvullende controle op sterkte-coördinatie

Buiten de scope van dit DO-rapport valt de controle van de schetsplaten en overige verbinding details in de constructie. Dit moet in de UO-fase worden uitgewerkt. Ook de voorzieningen voor de high-step rail en bordessen vallen onder uitwerking in UO-fase.

In hoofdstuk 2 zijn de uitgangspunten en randvoorwaarden vanuit de van toepassing zijnde normen en TenneT-specificaties opgenomen. Hoofdstuk 3 beschrijft de gevolgde aanpak van de berekening. In hoofdstuk 4 is de toetsing opgenomen.

2 UITGANGSPUNTEN EN RANDVOORWAARDEN

2.1 Normen

Er is gebruik gemaakt van de normen volgens Tabel 1.

Tabel 1 Gebruikgemaakte normen, voorschriften en richtlijnen

Norm	Titel
NEN-EN 50341-1:2013	“Overhead electrical lines exceeding AC 1 kV - Part 1: General requirements – Common”
NEN-EN 50341-2-15:2019	“Overhead electrical lines exceeding AC 1 kV Part 2 National Normative Aspects (NNA) for THE NETHERLANDS”
NEN-EN 1990+A1+A1/C2:2019/NB:2019nl	“Grondslagen van het ontwerp”
NEN-EN 1991-1-4+A1+C2:2011/NB:2019+C1:2020	“Deel 1-4: Windbelasting op constructies”
NEN-EN 1992-1-1+C2:2011/NB:2016+A1:2020	“Eurocode 2: Ontwerp en berekening van betonconstructies, deel 1-1: algemene regels en regels voor gebouwen”
NEN-EN 1993-1-1+C2+A1:2016 nl	“Eurocode 3: Ontwerp en berekening van staalconstructies, deel 1-1: algemene regels en regels voor gebouwen”
NEN-EN 1993-3-1:2007/NB:2011 nl	“Deel 3-1: Torens, masten en schoorstenen - Torens en masten”
NEN-EN 1993-1-8+C2:2011/NB:2011 nl	“Ontwerp en berekening van staalconstructies, deel 1-8: ontwerp en berekening van verbindingen”

2.2 TenneT-specificaties

In Tabel 2 zijn de documenten opgenomen die relevant zijn voor de berekeningen en toetsingen die binnen dit project in de mastrapportage uitgevoerd zullen worden.

Tabel 2 Relevante documenten t.b.v. mechanische rapportages

Nummer	Onderwerp
PVE.05.000 v3.2	PvE Lijnen
sPVE.05.001	sPvE Lijnen
SPE.05.346 v1.3	Algemene specificatie stalen masten

2.3 Eisenverificatie

Voor de eisenverificatie wordt verwezen naar het rapport “Verificatierapport eisen DO Moldau”, DNV GL rapport 21-0451, Meridiannummer 002.678.00 0910757.

2.4 Ontwerppapporten

Voor de achtergrond van het ontwerp wordt verwezen naar het uitgangspuntenrapport “Uitgangspunten definitief ontwerp Moldaumast”, DNV GL rapport 21-0036, Meridiannummer 002.678.00 0876917.

2.5 Materialen

Voor het ontwerp van de mastconstructies en fundaties wordt uitgegaan van de eigenschappen volgens Tabel 3.

Tabel 3 Materialen aangepaste constructie

Staalsoort	S355J0 (t≤16 mm) S355J2 (16<t≤40 mm)
Boutkwaliteit	8.8 gerolde draad
Betonkwaliteit	C30/37
Wapeningsstaal	B500



Voor de constructie geldt conform TenneT-specificatie:

- Toe te passen bouten: M16/M20/M24;
- Voor hoekstaal is de minimale afmeting L50x5 mm;
- Minimale plaatdikte 6 mm.

Mocht het noodzakelijk zijn M30 toe te passen, bij grote plaatdiktes is dit als afwijking door TenneT toegestaan.

2.6 Software

De gebruikte software wordt benoemd in Tabel 4.

Tabel 4 Toegepaste software

Software		Versie
Mastontwerp	PLS-CADD	16.65
Mastberekeningen	PLS-TOWER	16.65
Constructieve analyse	AxisVM	X5 R4h



3 MASTONTWERP

3.1 Mastbeelden

In dit hoofdstuk worden de mastbeelden weergegeven met de belangrijkste maatvoering, voor volledige tekeningen van de masttypen wordt verwezen naar onderstaande tekeningen:

- Mastbeeldtekening HA+0/c, Meridiannummer 002.678.00 0901943
- Mastbeeldtekening HA+3/c, Meridiannummer 002.678.00 0927472
- Mastbeeldtekening HA+6/c, Meridiannummer 002.678.00 0927480

Masttype HA/c is een combimast voor twee circuits 380 kV en twee circuits 150kV. De belastingen grijpen als trekkrachten aan via de afspankettingen. Onder de traverse bevinden zich verticale post-isolatoren die de bretellebogen fixeren

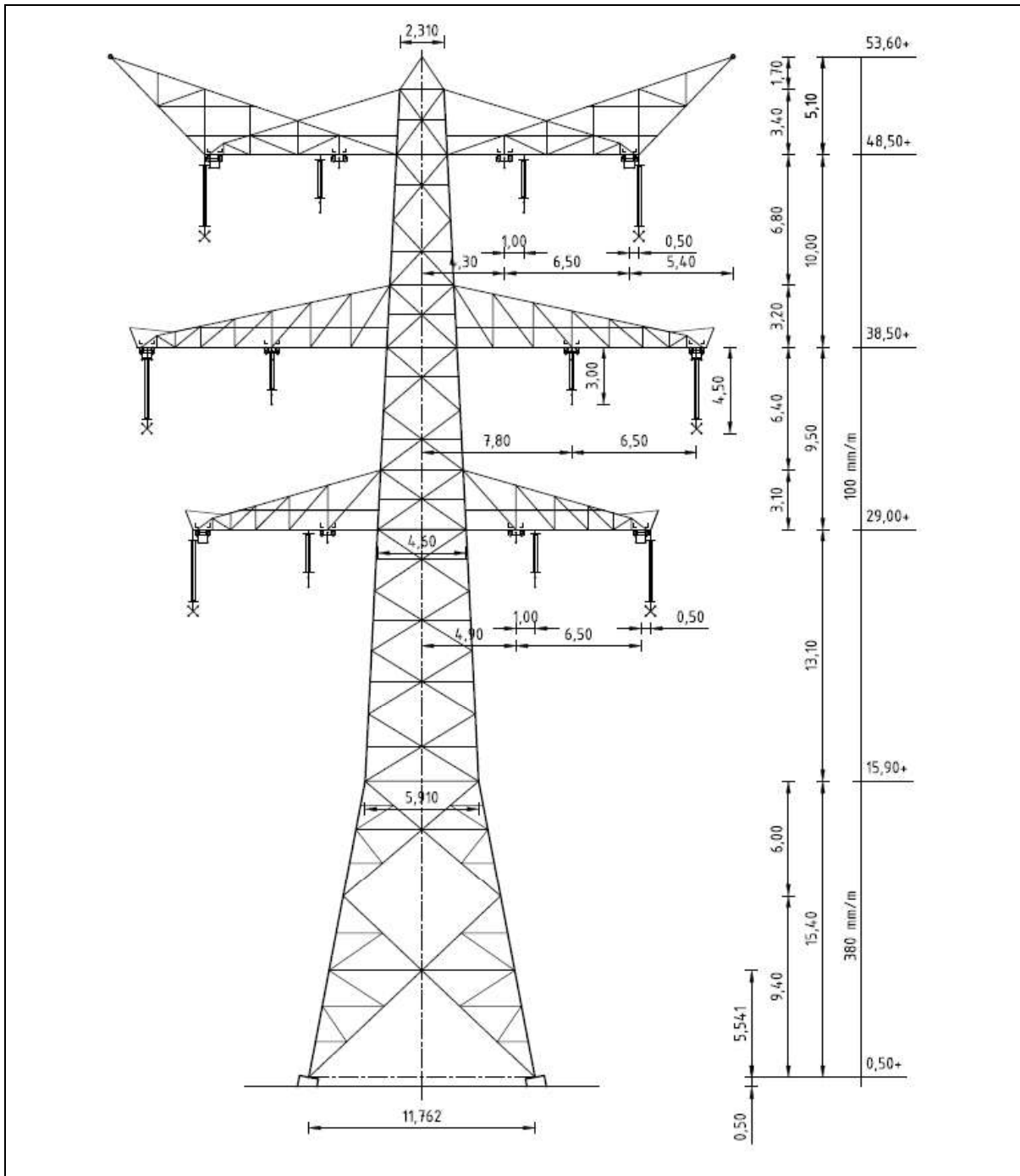

Figuur 1 Mastbeeld masttype HA+0/c

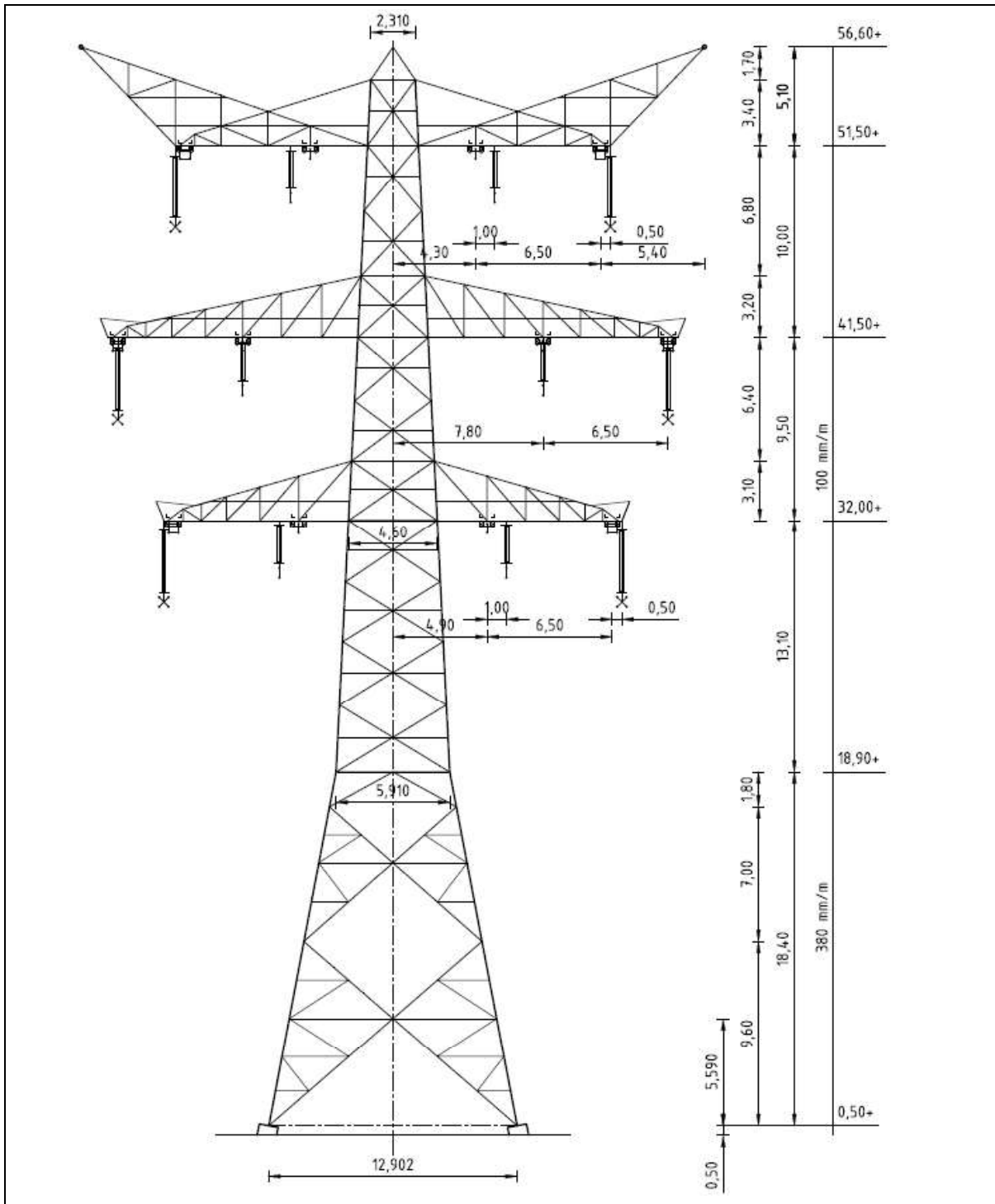

Figuur 2 Mastbeeld masttype HA+3/c

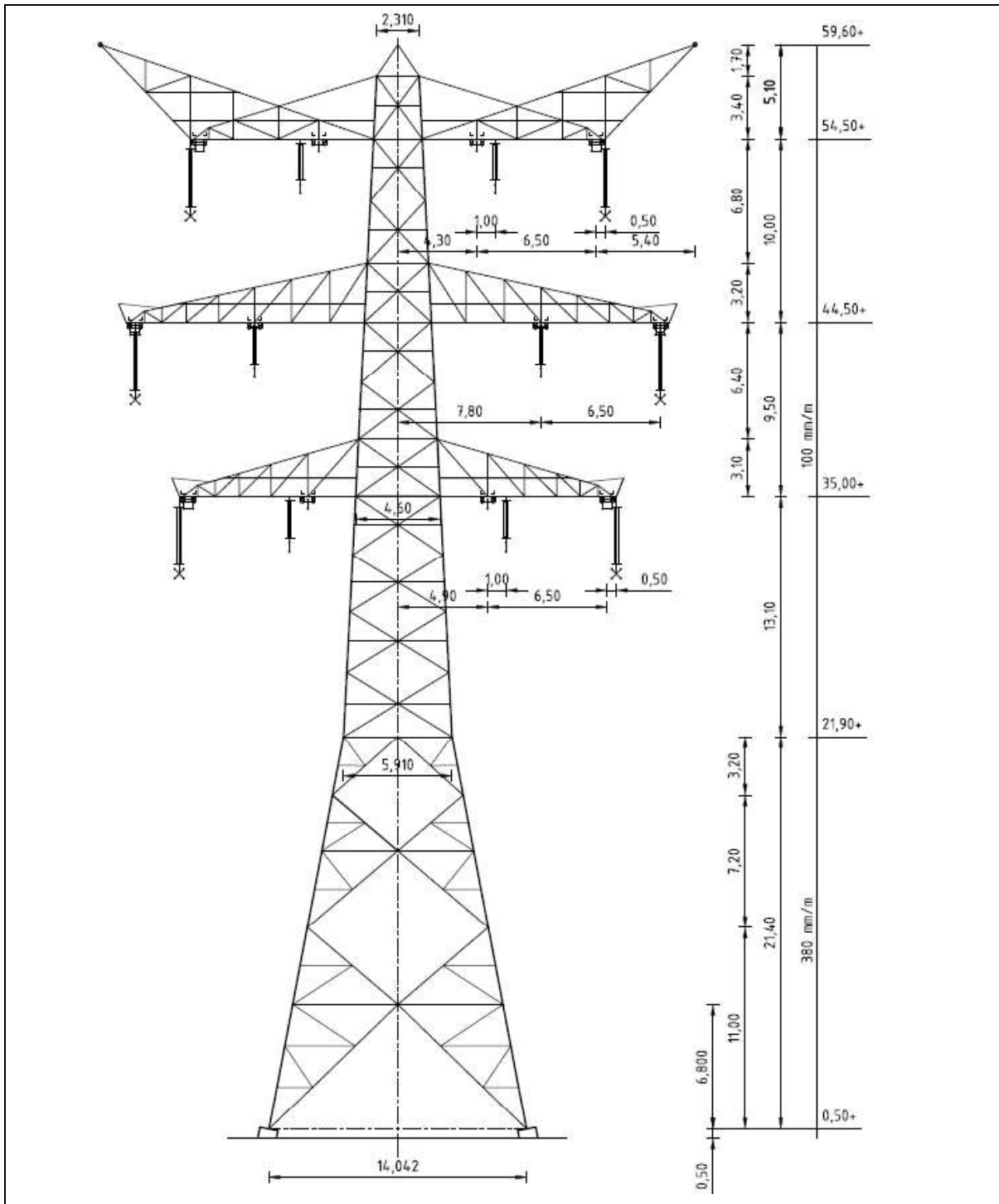

Figuur 3 Mastbeeld masttype HA+6/c

3.2 Uitgangspunten berekening

De uitgangspunten volgens Tabel 5 zijn van toepassing.

Tabel 5 Uitgangspunten

Norm	NEN-EN50341-2-15:2019
Gevolgklasse initieel	CC2
Betrouwbaarheidsniveau	Nieuwbouw
Referentieperiode	50 jaar
Windgebied	III
Windsnelheid (m/s)	24,5
Terreincategorie	II
Reductiefactor c_{dir}	1,00
IJsg gebied fasegeleider	B
IJsg gebied bliksemgeleider	A

3.3 Mastenlijst

De mastenlijst is gebaseerd op de “staking table” van het DO-uitgangspuntenrapport en vernoemd als “VKA 1.1 Concept 20201112 1037-1044_1086-1094_1099-1105_1192-1204.xlsx”. De mastenlijst is vanwege lopende traceringsvraagstukken aan verandering onderhevig en is derhalve indicatief.

In Tabel 6 *tot en met* Tabel 8 zijn alle masten in het tracé van het type HA+0/c, HA+3/c en HA+6/c opgenomen. De mast met grootste wind span is vetgedrukt aangegeven. Het masttype zal niet met deze wind en weight span worden berekend maar met generieke wind en weight span, zie uitgangspuntenrapport.

Tabel 6 Mastenlijst Masttype HA+0

Mast-nummer	Masttype	Lijnhoek (°)	Wind span (m)	Weight span (m)	Hoogteverschil ba+ah (m)	Hoogteverschil back (m)	Hoogteverschil ahead (m)
1044	HA+0_c	171,9	332,7	316,0	-2,8	-3,4	0,7
1086	HA+0_c	174,6	359,0	329,3	-6,3	-0,2	-6,1
1105	HA+0_c	176,9	368,6	354,9	-3,0	-2,9	-0,1
1123	HA+0_c	167,7	358,6	356,0	-0,5	-0,6	0,1
1130	HA+0_c	163,6	331,6	335,7	0,7	0,0	0,7
1188	HA+0_c	161,4	386,4	387,8	0,3	0,6	-0,3
1195	HA+0_c	168,9	269,6	262,0	-1,1	-0,1	-1,1

Tabel 7 Mastenlijst Masttype HA+3

Mast-nummer	Masttype	Lijnhoek (°)	Wind span (m)	Weight span (m)	Hoogteverschil ba+ah (m)	Hoogteverschil back (m)	Hoogteverschil ahead (m)
1094	HA+3_c	167,0	382,9	384,8	0,4	0,3	0,1
1095	HA+3_c	180,0	375,2	388,6	2,9	-0,1	3,0

Tabel 8 Mastenlijst Masttype HA+6

Mast-nummer	Masttype	Lijnhoek (°)	Wind span (m)	Weight span (m)	Hoogteverschil ba+ah (m)	Hoogteverschil back (m)	Hoogteverschil ahead (m)
1067	HA+6_c	167,6	352,7	381,9	5,0	4,9	0,1
1068	HA+6_c	173,3	397,1	399,1	0,4	-0,1	0,6
1069	HA+6_c	175,9	363,0	374,4	2,0	-0,6	2,5
1078	HA+6_c	173,8	398,8	374,3	-5,4	-5,8	0,4

3.4 Geleiderbelastingen

De berekening is uitgevoerd met het geleiderbelastingprogramma van DNV GL. De belastingen op de mastconstructie zijn bepaald op basis van de modellering in PLS-TOWER (staafoppervlaktes). Voor de toeslagen op eigen gewicht en windoppervlakte wordt verwezen naar het uitgangspuntenrapport. In Appendix A zijn de resultaten van de geleiderbelastingen samengevat.

3.5 Reacties op de fundering

De oplegreacties op de fundering worden ontleend aan de uitvoer van het geleiderbelastingprogramma. Zie Appendix A.

3.6 Modelling

Op basis van de ontwerptekeningen is de mast in PLS-TOWER ingevoerd. De toetsing wordt per staafgroep uitgevoerd. De hoofdelementen zijn gemodelleerd, niet-dragende profielen als knikverkorters zijn weggelaten, deze worden separaat getoetst. De profielen zijn in PLS-TOWER inclusief de boutverbindingen ingevoerd en getoetst, de controle van de schetsplaten en andere detailverbindingen valt buiten de scope.

De geleiderbelastingen vanuit het geleiderbelastingprogramma zijn als invoer voor de belastingen gebruikt.

De gewichts- en windbelasting op de mastconstructie wordt door PLS-TOWER automatisch bepaald. Via toeslagfactoren wordt de invloed van niet gemodelleerde elementen als knikverkorters, bordesconstructies en klimvoorzieningen meegenomen. Voor schetsplaten, zinklaag en bouten is een aanvullende toeslag op het gewicht van 20% toeslag gerekend.

Diagonalen in voor- en achtervlak respectievelijk de twee zijvlakken zijn samengenomen in een groep.

3.7 Overige controles

In PLS-TOWER zijn niet alle elementen getoetst. Knikverkorterprofielen en overige profielen voor beloopbaarheid worden separaat getoetst. In Appendix C is dit opgenomen. De verbinding met de fundatie bestaat uit ingestorte profielen voorzien van blokdeuvels. Dit is in Appendix D opgenomen. De liggers van isolatorkettingen vereisen een aanvullende controle op buiging. De toetsing is uitgevoerd met de software AxisVM en is beschreven in Appendix E. Appendix F omvat de toetsing op sterkte-coördinatie. Voor hoekmasten moet een toetsing op vermoeiing worden uitgevoerd voor galloping. Dit is in Appendix G opgenomen.

De mastranden uitgevoerd als XEA-profielen worden separaat op torsieknik gecontroleerd. Dit is in Appendix B opgenomen. De berekende capaciteit die lager is dan de capaciteit voor buigingsknik is in PLS-TOWER via aangepaste buckling-ratio ingevoerd.

3.8 Mastgewicht

Het totale mastgewicht per masttype is met de uitgangspunten van paragraaf 3.6 bepaald op:

- Masttype HA+0/c -> 99,5 ton;
- Masttype HA+3/c -> 107,0 ton;
- Masttype HA+6/c -> 114,6 ton.

4 TOETSING

4.1 Resultaat PLS-TOWER

Het resultaat van de toetsing met PLS-TOWER is per masttype weergegeven in Figuur 2 tot en met Tabel 8. Voor elk masttype zijn de belastingen apart bepaald. Alléén voor masttype HA+6/c bepalend voor het ontwerp van de mastkop, zijn deze ook inclusief bouwphase en afspannen

De uitnutting van de constructie loopt op van blauw (0-25%) tot geel (75-100%). Uit de figuur wordt geconcludeerd dat alle profielen en boutverbindingen voldoen.

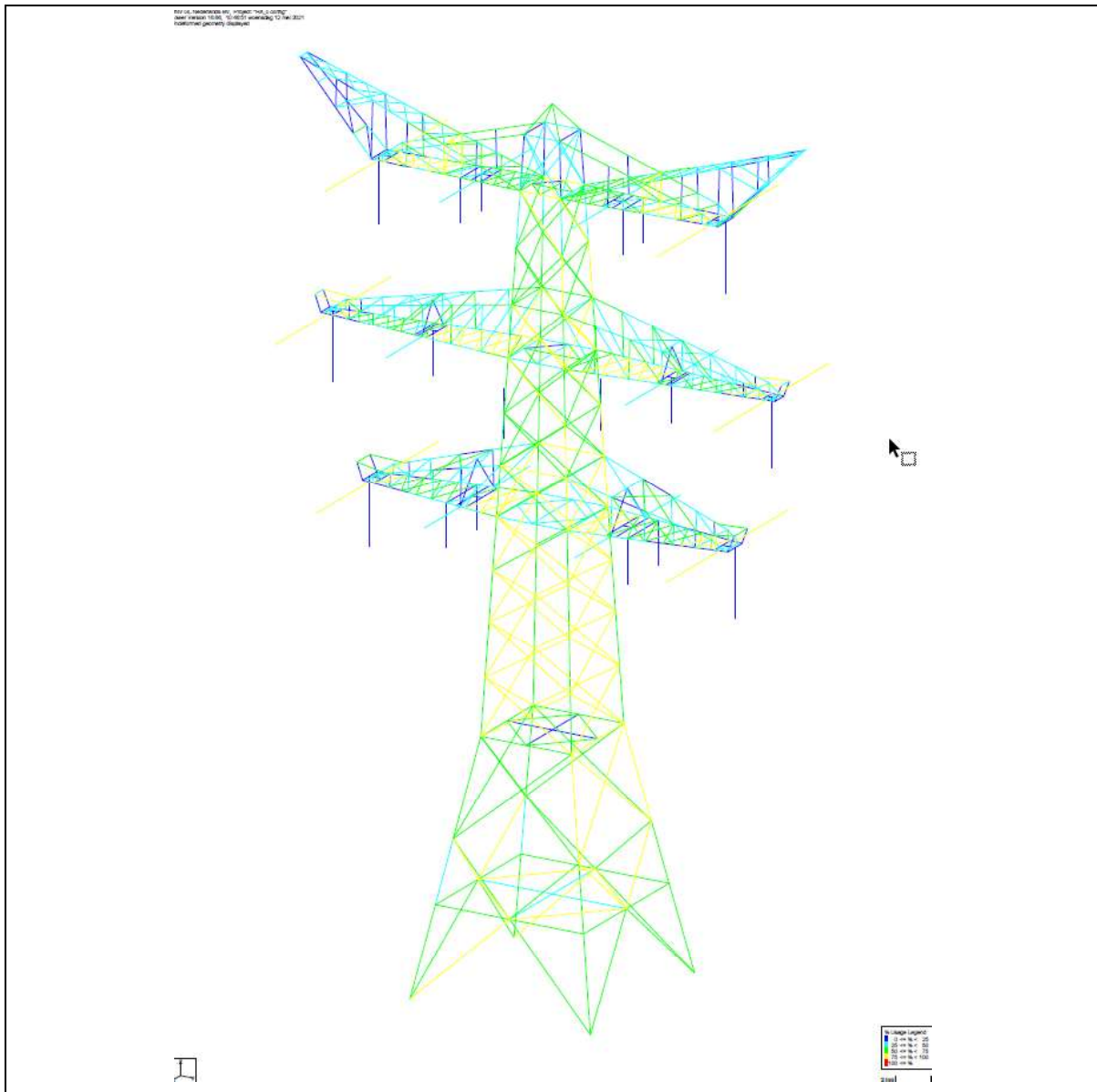

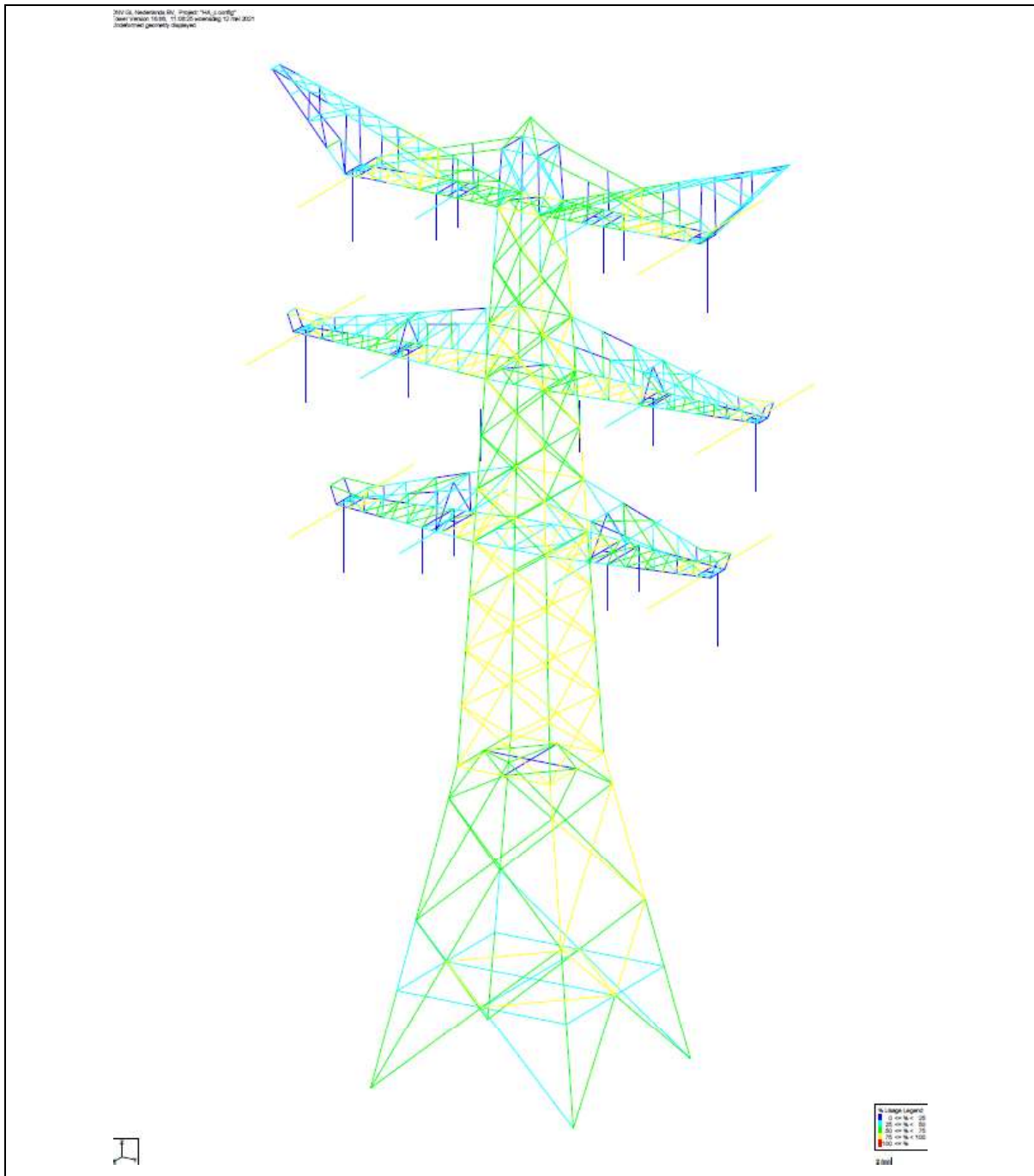

Figuur 5 Resultaat PLS-TOWER voor masttype HA+3/c

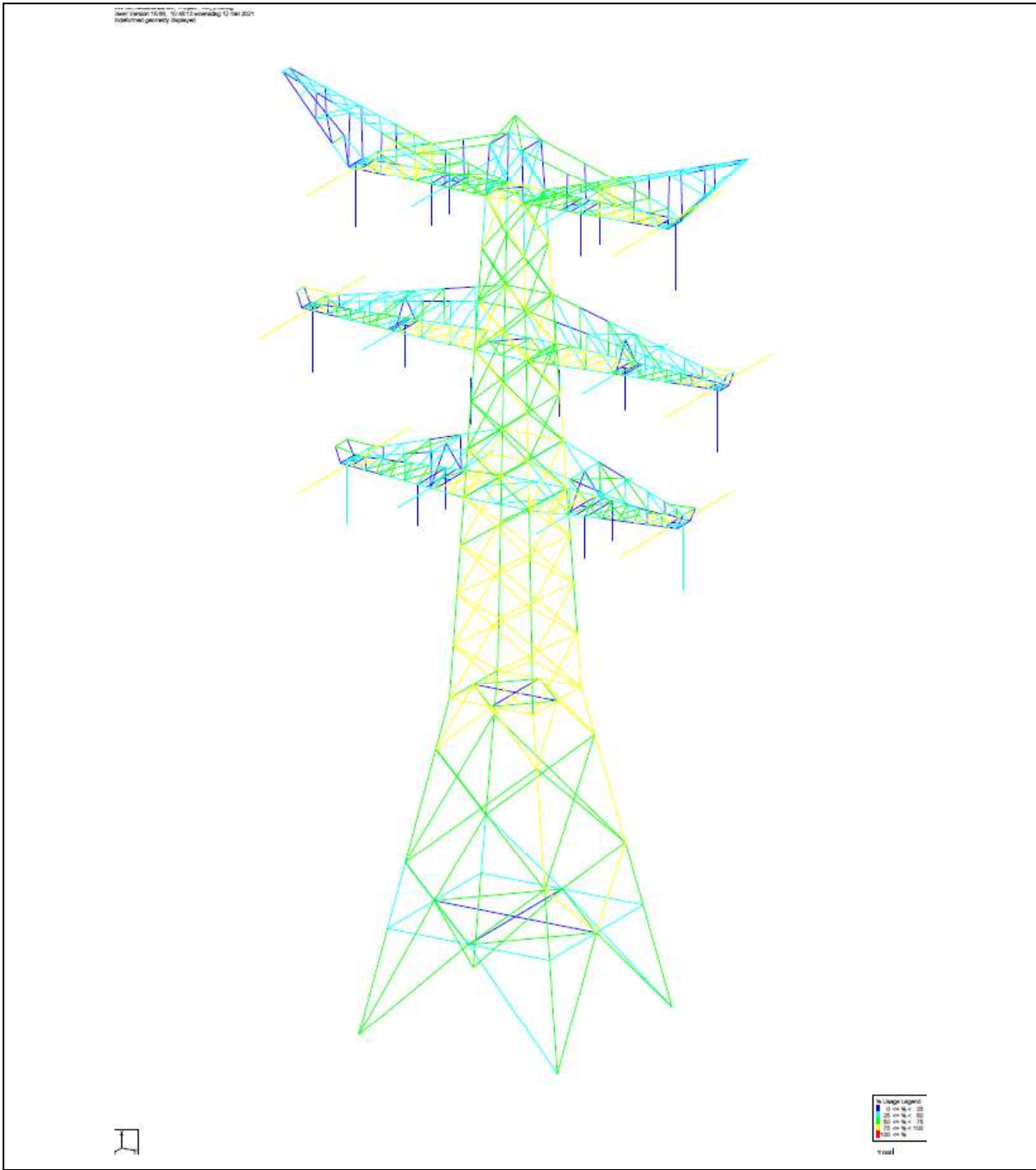

Figuur 6 Resultaat PLS-TOWER voor masttype HA+6/c

4.2 Toetsing overige onderdelen

In Tabel 7 zijn de resultaten van de uitgevoerde toetsingen weergegeven.

Tabel 9 Samenvatting uitgevoerde controles

Controle van	Beoordeling	Referentie
Profielen	Voldoen	Figuur 4 Figuur 5 Figuur 6 Appendix B
Knikverkorters	Voldoen	Appendix C
Blokdeuvels randstijl	Voldoen	Appendix D
Liggers	Voldoen	Appendix E
Sterkte-coördinatie	Voldoet	Appendix F

APPENDIX A

Geleiderbelastingen

Geleiderbelastingen opgenomen:

- Masttype HA+0/c
- Masttype HA+3/c
- Masttype HA+6/c
- Masttype HA+6/c bouwfase
- Afspannen

Project: RLL-TLB380
Tower: HA+0_c
Number: 1188

Auteur: TBR
Versie: v12.0

Geleiderbelastingen

Algemeen

Benaming HA+0_c
Masttype Hoekmast
Aantal circuits 4
Configuratie 4-circuit-dubbel verticaal
Aantal bliksemgeleiders 2

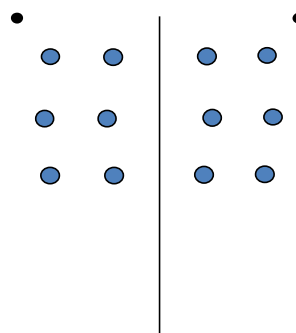

Configuratie geleiders

Uitgangspunten

Norm NEN-EN50341-2-15:2019
Gevolgklasse initieel CC2
Betrouwbaarheidsniveau initieel Nieuwbouw
Referentieperiode initieel 50 jaar
Betrouwbaarheidsniveau na aanpassing n.v.t.
50 jaar
Windgebied III
Windsnelheid (m/s) 24,5 m/s
Terreincategorie II
Reductiefactor C_{dir} 1,00
IJsgebied fasegeleider B
IJsgebied bliksemgeleider A

Geleiders Back

Omschrijving	Spanning	Geleider Back	Bundel Ba	IJsgebied	Toeslag gewicht	Toeslag diameter	Intrekwaarden P_{back}
Circuit 1	380 kV	AAAC-AL7 620	4	B	3 %	3 %	1800
Circuit 2	380 kV	AAAC-AL7 620	4	B	3 %	3 %	1800
Circuit 3	150 kV	AAAC-AL7 620	2	B	3 %	3 %	1800
Circuit 4	150 kV	AAAC-AL7 620	2	B	3 %	3 %	1800
Bliksemdraad 1		AACSR 241-AL3-39-A20SA	1	A	2 %	2 %	1800
Bliksemdraad 2		OPGW AFL-226/38	1	A	2 %	2 %	1800

Geleiders Ahead

Omschrijving	Spanning	Geleider Ahead	Bundel Ah	IJsgebied	Toeslag gewicht	Toeslag diameter	Intrekwaarden P_{ahead}
Circuit 1	380 kV	AAAC-AL7 620	4	B	3 %	3 %	1800
Circuit 2	380 kV	AAAC-AL7 620	4	B	3 %	3 %	1800
Circuit 3	150 kV	AAAC-AL7 620	2	B	3 %	3 %	1800
Circuit 4	150 kV	AAAC-AL7 620	2	B	3 %	3 %	1800
Bliksemdraad 1		AACSR 241-AL3-39-A20SA	1	A	2 %	2 %	1800
Bliksemdraad 2		OPGW AFL-226/38	1	A	2 %	2 %	1800

Isolatoren (1)

Omschrijving	Ophanging	Gewicht [kN]	Lengte [m]	Windopp. [m ²]
Circuit 1	Afspanketting	3,00	6,50	1,10
Circuit 2	Afspanketting	3,00	6,50	1,10
Circuit 3	Afspanketting	2,00	3,50	0,80
Circuit 4	Afspanketting	2,00	3,50	0,80
Bliksemdraad 1	Afspanketting	0,10	0,20	0,10
Bliksemdraad 2	Afspanketting	0,10	0,20	0,10

1. Eigenschappen gelden voor geheel van de isolatorset

Ophanghoogte en positie in mast

Circuits	Aanduiding	Nummer	Ophanghoogte	Aangrijppunt	Positie in mast Horizontale afstand
Circuit 1	10	380ct1f1	48,0 m	48,0 m	-10,8 m
Circuit 1	11	380ct1f2	38,0 m	38,0 m	-14,3 m
Circuit 1	12	380ct1f3	28,5 m	28,5 m	-11,4 m
Circuit 2	40	380ct2f1	48,0 m	48,0 m	10,8 m
Circuit 2	41	380ct2f2	38,0 m	38,0 m	14,3 m
Circuit 2	42	380ct2f3	28,5 m	28,5 m	11,4 m
Circuit 3	20	150ct3f1	48,0 m	48,0 m	-4,3 m
Circuit 3	21	150ct3f2	38,0 m	38,0 m	-7,8 m
Circuit 3	22	150ct3f3	28,5 m	28,5 m	-4,9 m
Circuit 4	30	150ct4f1	48,0 m	48,0 m	4,3 m
Circuit 4	31	150ct4f2	38,0 m	38,0 m	7,8 m
Circuit 4	32	150ct4f3	28,5 m	28,5 m	4,9 m
Bliksemdraad 1	1	bl1	53,1 m	53,1 m	-16,2 m
Bliksemdraad 2	3	bl2	53,1 m	53,1 m	16,2 m

Project: RLL-TLB380
 Tower: HA+0_c
 Number: 1188

Hoogteaanpassing naastgelegen masten (aanpassing wind- en weight span)

	Back	Ahead	
Verhoging voor windbelasting	18,0 m	6,0 m	(positief: omhoog)
Verlaging voor verticale belasting	-9,0 m	-9,0 m	(negatief: omlaag, grotere weight span)
Verlaging:	Niet in 0,9EG-combinaties		

Hoogteafwijking mastbeeld naastgelegen masten en richtingsverandering t.o.v. Lijnrichting

Circuits	Aanduiding	Nummer	Hoogteverschil		Richtingsverandering	
			Δh back	Δh ahead	Δy back	Δy ahead
Circuit 1	10	380ct1f1	0,0	0,0 m	0,0	0,0 m
Circuit 1	11	380ct1f2	0,0	0,0 m	0,0	0,0 m
Circuit 1	12	380ct1f3	0,0	0,0 m	0,0	0,0 m
Circuit 2	40	380ct2f1	0,0	0,0 m	0,0	0,0 m
Circuit 2	41	380ct2f2	0,0	0,0 m	0,0	0,0 m
Circuit 2	42	380ct2f3	0,0	0,0 m	0,0	0,0 m
Circuit 3	20	150ct3f1	0,0	0,0 m	0,0	0,0 m
Circuit 3	21	150ct3f2	0,0	0,0 m	0,0	0,0 m
Circuit 3	22	150ct3f3	0,0	0,0 m	0,0	0,0 m
Circuit 4	30	150ct4f1	0,0	0,0 m	0,0	0,0 m
Circuit 4	31	150ct4f2	0,0	0,0 m	0,0	0,0 m
Circuit 4	32	150ct4f3	0,0	0,0 m	0,0	0,0 m
Bliksemdraad 1	1	bl1	0,0	0,0 m	0,0	0,0 m
Bliksemdraad 2	3	bl2	0,0	0,0 m	0,0	0,0 m

Lijn- en mastgegevens

	Back	Ahead
Ruling span $\sqrt{(\Sigma L^3)/\Sigma L}$	400,0	400,0 m
Lijnhoek β	160 °	
Rotatie mast t.o.v. bissectrice θ	0 °	
Vaklengte	400	400 m
Hoogte onderkant mast t.o.v. maaiveld	0,5 m	
Beschouwde windrichtingen	α_1	0 °
Windrichtingen volgens:	α_2	45 °
Geleiderbelastingen	α_3	90 °
	α_4	135 °
	α_5	80 °
	α_6	100 °

Windrichtingen gelden t.o.v. hoofdrichting mastconstructie, niet t.o.v. bissectrice.

Windrichtingen en positieve richtingen belastingen

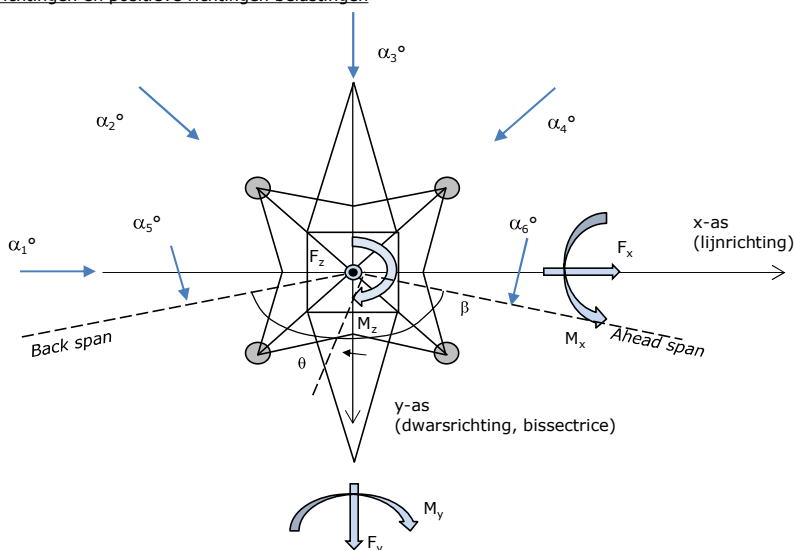

Beschouwd aantal windrichtingen

1a	6
3	6
4	1
6	1
Overig	1

Project: RLL-TLB380
 Tower: HA+0_c
 Number: 1188

Geleiderafval

		SPLS - torsie		SPLS - Enkelzijdige trek		5a - geleiderbreuk	
		Aanw.	Afw.	Aanw.	Afw.	Aanw.	Afw.
Circuit 1	380ct1f1	1	0	1	0	1	0
Circuit 1	380ct1f2	1	0	1	0	1	0
Circuit 1	380ct1f3	1	0	1	0	1	0
Circuit 2	380ct2f1	0	1	1	0	1	0
Circuit 2	380ct2f2	0	1	1	0	1	0
Circuit 2	380ct2f3	0	1	1	0	1	0
Circuit 3	150ct3f1	1	0	1	0	1	0
Circuit 3	150ct3f2	1	0	1	0	1	0
Circuit 3	150ct3f3	1	0	1	0	1	0
Circuit 4	150ct4f1	0	1	1	0	1	0
Circuit 4	150ct4f2	0	1	1	0	1	0
Circuit 4	150ct4f3	0	1	1	0	1	0
Bliksemdraad 1	b11	1	0	1	0	1	0
Bliksemdraad 2	b12	0	1	1	0	1	0

Belastingssituaties SPLS

Beschouwde situaties SPLS: 1 t/m 6, alle mogelijke situaties.

Principe belastingssituaties:

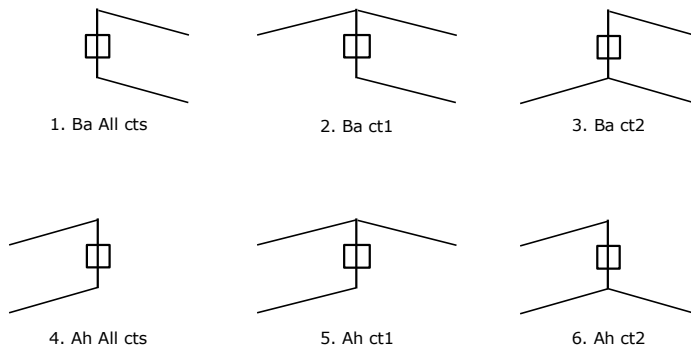

Belastingssituaties 5a. Geleiderbreuk

Beschouwde situaties geleiderbreuk 5a: 1 en 2, alle mogelijke situaties.

Principe belastingssituaties:

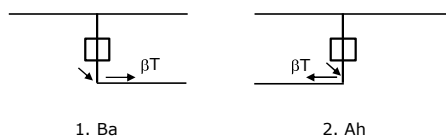

Project: RLL-TLB380
 Tower: HA+0_c
 Number: 1188

Belastingsituaties 6. Bouw- en onderhoud

Onder 6a wordt de belasting door aanwezigheid lijnwagen of lijnfiets in combinatie met puntlast op traverse in rekening gebracht. Combinatie 6b bevat geen belastingen in geleider of op traverse. Deze combinatie is toegevoegd om te kunnen combineren met separate controle bordessen etc. De situaties worden in ULS en in iedere SPLS-situatie (in geval van hoekmast) toegepast.

	Fase	Bliksem
Lijnwagen	4,0 kN	2,0 kN
Puntlast op traverse	1,0 kN	1,0 kN

Beschouwde situaties bouw- en onderhoud 6a: 1 t/m 4, alle mogelijke situaties.

Aanwezigheid lijnwagen: Circuit, belasting tegelijk aanwezig in alle geleiders per circuit.

Principe belastingssituaties:

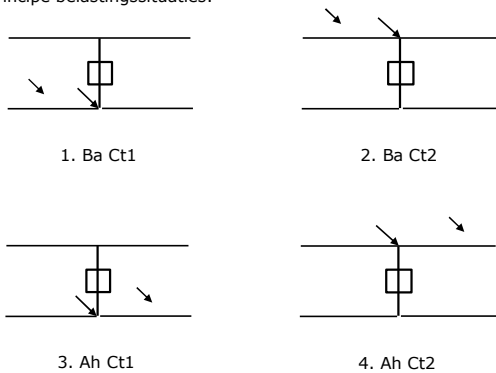

Belastingsituaties 8. Lijndansen als statische belasting

Geleider		
Steunmast fase	0,866 W	1,5 W
Steunmast bliksem	1,5 EDS	1,5 W
Hoekmast fase en bliksem	1,5 EDS	1,5 W

Beschouwde situaties lijndansen 8: 1 en 2, alle mogelijke situaties.

Belasting tegelijk aanwezig in alle geleiders van het circuit.

Principe belastingssituaties:

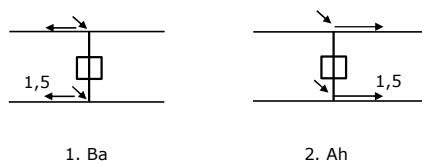

Belastingcombinatie 8. Lijndansen als dynamische belasting

Alleen van toepassing op hoek- en eindmasten
 Belasting bestaat uit EDS-trekbelasting in één van de geleiders aan één zijde van de mast
 Door gebruiker via het belastingsspectrum van tabel 4.11/NL.1 om te zetten naar spanningspectrum

Project: RLL-TLB380
 Tower: HA+0_c
 Number: 1188

Mastconstructie

Eigenschappen

Masttype	Hoekmast	
Mastbenaming	HA+0_c	
Voetplaat t.o.v. maaiveld	0,5 m	
Masthoogte t.o.v. voetplaat	53,1 m	
Gewicht mast	976,4 kN	
<i>Breedte en helling mast bij fundatie</i>	<i>x-ri.</i>	<i>y-ri.</i>
Pootsprei	11,76	11,76 m
Helling van de randstijl	0,190	0,190 -
Factor spatkracht	1,1	1,1 -

Berekening windbelasting

Dynamische invloed G_T	1,00 (<i>Masthoogte < 60 m</i>)
Windbelasting overhoeks op mastlichaam evenredig met:	$(A1C1\sin^2(\phi)+A2C2\cos^2(\phi))$
Windbelasting overhoeks op traverse evenredig met:	$(A1C1\sin^2(\phi)+A2C2\cos^2(\phi))$
Vergroting wind overhoeks mastlichaam	$(1+0,2\sin^2(2\phi))$
Vergroting wind overhoeks traverse	$(1+0,2\sin^2(2\phi))$
Factor wind evenwijdig t.o.v. haaks op traverse	0,4

Eigenschappen mastsecties langsrichting (vooraanzicht, yz-vlak)

Omschrijving	h [m]	b ₁ [m]	b ₂ [m]	Δh [m]	Δ _x [m]	A ₀ [m ²]	A ₁ [m ²]	χ = A ₁ /A ₀ [-]	C _t
Broekstuk	15,40	11,76	5,91	15,40	0,190	136,07	31,47	0,23	2,80
Eerste tussenstuk	22,20	5,91	5,23	6,80	0,050	37,88	13,24	0,35	2,37
Tweede tussenstuk	28,50	5,23	4,60	6,30	0,050	30,96	10,25	0,33	2,43
Bovenstuk 1	38,00	4,60	3,65	9,50	0,050	39,19	11,88	0,30	2,52
Bovenstuk 2	51,40	3,65	2,31	13,40	0,050	39,93	13,01	0,33	2,45
Topstuk	53,10	2,31		1,70		1,96	0,33	0,17	3,08
Ondertraverse	28,50	9,40		3,10		14,57	4,37	0,30	2,54
Middentraverse	38,00	12,78		3,20		20,45	6,34	0,31	2,50
Boventraverse	48,00	14,88		5,10		37,93	7,34	0,19	2,96

Eigenschappen mastsecties dwarsrichting (zijaanzicht, xz-vlak)

Omschrijving	h [m]	b ₁ [m]	b ₂ [m]	Δh [m]	Δ _x [m]	A ₀ [m ²]	A ₁ [m ²]	χ = A ₁ /A ₀ [-]	C _t
Broekstuk	15,40	11,76	5,91	15,40	0,190	136,07	31,47	0,23	2,80
Eerste tussenstuk	22,20	5,91	5,23	6,80	0,050	37,88	13,24	0,35	2,37
Tweede tussenstuk	28,50	5,23	4,60	6,30	0,050	30,96	10,25	0,33	2,43
Bovenstuk 1	38,00	4,60	3,65	9,50	0,050	39,19	11,88	0,30	2,52
Bovenstuk 2	51,40	3,65	2,31	13,40	0,050	39,93	13,01	0,33	2,45
Topstuk	53,10	2,31		1,70		1,96	0,33	0,17	3,08
Ondertraverse	28,50	9,40		3,10		14,57	4,37	0,30	2,54
Middentraverse	38,00	12,78		3,20		20,45	6,34	0,31	2,50
Boventraverse	48,00	14,88		5,10		37,93	7,34	0,19	2,96

NB: oppervlakte traverse dwarsrichting van de tabel wordt in berekening gereduceerd.
 NB: oppervlakte traverse per zijde, dus helft van totaal van twee traveses.

Project: RLL-TLB380
 Tower: HA+0_c
 Number: 1188

Windoppervlak feeders telecominstallaties

Onderdeel	A (m ² /m)	Factor	Δh	A ₁
Broekstuk	0,14	0,71	15,4	1,5
Eerste tussenstuk	0,14	0,71	6,8	0,7
Tweede tussenstuk	0,14	0,71	6,3	0,6
Bovenstuk 1	0,14	0,71	9,5	0,9
Bovenstuk 2				

Invoer antennes

Omschrijving	A (m ²)	h (m)	C _i (m)
Antenne top			
Antenne o.t.	4,7	34,7	1,5

Belastingen mastsectie langsrichting (x-richting) per windrichting

Omschrijving	P _w [kN/m ²]	F _{x1} [kN]	F _{x2} [kN]	F _{x3} [kN]	F _{x4} [kN]	h _{ef} [m]	M _{y1} [kNm]	M _{y2} [kNm]	M _{y3} [kNm]	M _{y4} [kNm]
Broekstuk	0,70	61,7	52,4	0,0	-52,4	7,7	475,5	403,4	0,0	-403,4
Eerste tussenstuk	0,86	27,0	22,9	0,0	-22,9	18,8	507,6	430,7	0,0	-430,7
Tweede tussenstuk	0,94	23,4	19,9	0,0	-19,9	25,4	594,1	504,1	0,0	-504,1
Bovenstuk 1	1,02	30,6	26,0	0,0	-26,0	33,3	1018,5	864,2	0,0	-864,2
Bovenstuk 2	1,10	35,1	29,8	0,0	-29,8	44,7	1567,6	1330,2	0,0	-1330,2
Topstuk	1,15	1,2	1,0	0,0	-1,0	52,3	60,7	51,5	0,0	-51,5
Ondertraverse	0,98	21,8	12,9	0,0	-12,9	29,5	643,5	382,2	0,0	-382,2
Middentraverse	1,06	33,7	20,0	0,0	-20,0	39,1	1316,8	782,2	0,0	-782,2
Boventraverse	1,13	49,3	29,3	0,0	-29,3	49,7	2447,7	1453,9	0,0	-1453,9
Totaal		283,8	214,1	0,0	-214,1		8632,0	6202,4	0,0	-6202,4

Belastingen mastsectie dwarsrichting (y-richting) per windrichting

Omschrijving	P _w [kN/m ²]	F _{y1} [kN]	F _{y2} [kN]	F _{y3} [kN]	F _{y4} [kN]	h _{ef} [m]	M _{x1} [kNm]	M _{x2} [kNm]	M _{x3} [kNm]	M _{x4} [kNm]
Broekstuk	0,70	0,0	52,4	61,7	52,4	7,7	0,0	403,4	475,5	403,4
Eerste tussenstuk	0,86	0,0	22,9	27,0	22,9	18,8	0,0	430,7	507,6	430,7
Tweede tussenstuk	0,94	0,0	19,9	23,4	19,9	25,4	0,0	504,1	594,1	504,1
Bovenstuk 1	1,02	0,0	26,0	30,6	26,0	33,3	0,0	864,2	1018,5	864,2
Bovenstuk 2	1,10	0,0	29,8	35,1	29,8	44,7	0,0	1330,2	1567,6	1330,2
Topstuk	1,15	0,0	1,0	1,2	1,0	52,3	0,0	51,5	60,7	51,5
Ondertraverse	0,98	0,0	12,9	8,7	12,9	29,5	0,0	382,2	257,4	382,2
Middentraverse	1,06	0,0	20,0	13,5	20,0	39,1	0,0	782,2	526,7	782,2
Boventraverse	1,13	0,0	29,3	19,7	29,3	49,7	0,0	1453,9	979,1	1453,9
Totaal		0,0	214,1	220,9	214,1		0,0	6202,4	5987,2	6202,4

Resulterende belastingen vanuit mastconstructie incl. antenne zonder geleiders niveau fundatie (kar. waarde)

Belasting / windrichting	F _x [kN]	F _y [kN]	F _z [kN]	M _x [kNm]	M _y [kNm]	M _z [kNm]
Permanente belasting	0	0	976	0	0	0
Windrichting 0°	291	0	0	0	8884	0
Windrichting 45°	219	219	0	6381	6381	0
Windrichting 90°	0	228	0	6239	0	0
Windrichting 135°	-219	219	0	6381	-6381	0

Project: RLL-TLB380
 Tower: HA+0_c
 Number: 1188

Tussenresultaten geleiderbelastingen

Geleiders back

Circuit	Geleider	Diameter [mm]	A [mm ²]	G [N/m]	E [N/mm ²]	αT [-]
Circuit 1	AAAC-AL7 620	32,4	621,0	17,71	56000	2,30E-05
Circuit 2	AAAC-AL7 620	32,4	621,0	17,71	56000	2,30E-05
Circuit 3	AAAC-AL7 620	32,4	621,0	17,71	56000	2,30E-05
Circuit 4	AAAC-AL7 620	32,4	621,0	17,71	56000	2,30E-05
Bliksemdraad 1	AACSR 241-AL3-39-A20SA	21,8	281,0	9,38	70165	1,97E-05
Bliksemdraad 2	OPGW AFL-226/38	21,7	264,0	9,13	72000	1,98E-05

Geleiders ahead

Circuit	Geleider	Diameter [mm]	A [mm ²]	G [N/m]	E [N/mm ²]	αT [-]
Circuit 1	AAAC-AL7 620	32,4	621,0	17,71	56000	2,30E-05
Circuit 2	AAAC-AL7 620	32,4	621,0	17,71	56000	2,30E-05
Circuit 3	AAAC-AL7 620	32,4	621,0	17,71	56000	2,30E-05
Circuit 4	AAAC-AL7 620	32,4	621,0	17,71	56000	2,30E-05
Bliksemdraad 1	AACSR 241-AL3-39-A20SA	21,8	281,0	9,38	70165	1,97E-05
Bliksemdraad 2	OPGW AFL-226/38	21,7	264,0	9,13	72000	1,98E-05

Verticale belasting back

Circuit	Bundel [-]	Toeslag [%]	$W_{z,G}$ [N/m]	IJsgebied	Formule	$W_{z,ijs}$ [N/m]	$W_{z,ijs,bundel}$ [N/m]
Circuit 1	4	3	73,0	B	4+0,2d	10,5	41,9
Circuit 2	4	3	73,0	B	4+0,2d	10,5	41,9
Circuit 3	2	3	36,5	B	4+0,2d	10,5	21,0
Circuit 4	2	3	36,5	B	4+0,2d	10,5	21,0
Bliksemdraad 1	1	2	9,6	A	15+0,4d	23,7	23,7
Bliksemdraad 2	1	2	9,3	A	15+0,4d	23,7	23,7

Verticale belasting ahead

Circuit	Bundel [-]	Toeslag [%]	$W_{z,G}$ [N/m]	IJsgebied	Formule	$W_{z,ijs}$ [N/m]	$W_{z,ijs,bundel}$ [N/m]
Circuit 1	4	3	73,0	B	4+0,2d	10,5	41,9
Circuit 2	4	3	73,0	B	4+0,2d	10,5	41,9
Circuit 3	2	3	36,5	B	4+0,2d	10,5	21,0
Circuit 4	2	3	36,5	B	4+0,2d	10,5	21,0
Bliksemdraad 1	1	2	9,6	A	15+0,4d	23,7	23,7
Bliksemdraad 2	1	2	9,3	A	15+0,4d	23,7	23,7

Isolatoren

Geleider	$G_{isolator}$ [kN]	Aantal	$F_{v,iso}$ [kN]	Lengte [m]	Windopp. [m ²]	Windhoogte [m]	Stuwdruk [kN/m ²]	Vormfactor [-]	$F_{h,iso}$ [kN]
380ct1f1	3,00	1	3	6,5	1,1	48,50	1,13	1,2	1,49
380ct1f2	3,00	1	3	6,5	1,1	38,50	1,06	1,2	1,40
380ct1f3	3,00	1	3	6,5	1,1	29,00	0,98	1,2	1,29
380ct2f1	3,00	1	3	6,5	1,1	48,50	1,13	1,2	1,49
380ct2f2	3,00	1	3	6,5	1,1	38,50	1,06	1,2	1,40
380ct2f3	3,00	1	3	6,5	1,1	29,00	0,98	1,2	1,29
150ct3f1	2,00	1	2	3,5	0,8	48,50	1,13	1,2	1,08
150ct3f2	2,00	1	2	3,5	0,8	38,50	1,06	1,2	1,02
150ct3f3	2,00	1	2	3,5	0,8	29,00	0,98	1,2	0,94
150ct4f1	2,00	1	2	3,5	0,8	48,50	1,13	1,2	1,08
150ct4f2	2,00	1	2	3,5	0,8	38,50	1,06	1,2	1,02
150ct4f3	2,00	1	2	3,5	0,8	29,00	0,98	1,2	0,94
bl1	0,10	1	0,1	0,2	0,1	53,60	1,16	1,2	0,14
bl2	0,10	1	0,1	0,2	0,1	53,60	1,16	1,2	0,14

Project: RLL-TLB380
 Tower: HA+0_c
 Number: 1188

Windbelasting back

Geleider	hoogte		G _{c,dwars}	G _{c,trek}	C _c	d _{toeslag}	W _y	W _{y,vak}	D _{jjs,toeslag}	W _{y,ijs}	W _{y,ijs,vak}
	wind	Stuwdruk									
	[m]	[kN/m ²]	[-]	[-]	[-]	[mm]	[N/m]	[N/m]	[mm]	[N/m]	[N/m]
380ct1f1	50,1	1,14	0,62	0,68	0,96	33,37	89,8	98,8	51,8	174,5	191,9
380ct1f2	40,1	1,07	0,60	0,66	0,98	33,37	84,0	92,4	51,8	159,9	175,9
380ct1f3	30,6	0,99	0,58	0,64	1,00	33,37	77,1	84,9	51,8	143,2	157,6
380ct2f1	50,1	1,14	0,62	0,68	0,96	33,37	89,8	98,8	51,8	174,5	191,9
380ct2f2	40,1	1,07	0,60	0,66	0,98	33,37	84,0	92,4	51,8	159,9	175,9
380ct2f3	30,6	0,99	0,58	0,64	1,00	33,37	77,1	84,9	51,8	143,2	157,6
150ct3f1	50,1	1,14	0,62	0,68	0,96	33,37	44,9	49,4	51,8	87,3	95,9
150ct3f2	40,1	1,07	0,60	0,66	0,98	33,37	42,0	46,2	51,8	79,9	88,0
150ct3f3	30,6	0,99	0,58	0,64	1,00	33,37	38,6	42,4	51,8	71,6	78,8
150ct4f1	50,1	1,14	0,62	0,68	0,96	33,37	44,9	49,4	51,8	87,3	95,9
150ct4f2	40,1	1,07	0,60	0,66	0,98	33,37	42,0	46,2	51,8	79,9	88,0
150ct4f3	30,6	0,99	0,58	0,64	1,00	33,37	38,6	42,4	51,8	71,6	78,8
bl1	55,2	1,17	0,62	0,69	1,18	22,24	19,1	21,0	63,1	55,2	60,6
bl2	55,2	1,17	0,62	0,69	1,18	22,13	19,0	20,9	63,0	55,1	60,5

Windbelasting ahead

Geleider	hoogte		G _{c,dwars}	G _{c,trek}	C _c	d _{toeslag}	W _y	W _{y,vak}	D _{jjs,toeslag}	W _{y,ijs}	W _{y,ijs,vak}
	wind	Stuwdruk									
	[m]	[kN/m ²]	[-]	[-]	[-]	[mm]	[N/m]	[N/m]	[mm]	[N/m]	[N/m]
380ct1f1	44,1	1,10	0,61	0,67	0,97	33,37	86,5	95,1	51,8	166,0	182,6
380ct1f2	34,1	1,02	0,59	0,65	0,99	33,37	79,9	87,9	51,8	149,7	164,8
380ct1f3	24,6	0,93	0,56	0,62	1,02	33,37	71,7	78,9	51,8	130,4	143,6
380ct2f1	44,1	1,10	0,61	0,67	0,97	33,37	86,5	95,1	51,8	166,0	182,6
380ct2f2	34,1	1,02	0,59	0,65	0,99	33,37	79,9	87,9	51,8	149,7	164,8
380ct2f3	24,6	0,93	0,56	0,62	1,02	33,37	71,7	78,9	51,8	130,4	143,6
150ct3f1	44,1	1,10	0,61	0,67	0,97	33,37	43,2	47,6	51,8	83,0	91,3
150ct3f2	34,1	1,02	0,59	0,65	0,99	33,37	39,9	43,9	51,8	74,9	82,4
150ct3f3	24,6	0,93	0,56	0,62	1,02	33,37	35,8	39,5	51,8	65,2	71,8
150ct4f1	44,1	1,10	0,61	0,67	0,97	33,37	43,2	47,6	51,8	83,0	91,3
150ct4f2	34,1	1,02	0,59	0,65	0,99	33,37	39,9	43,9	51,8	74,9	82,4
150ct4f3	24,6	0,93	0,56	0,62	1,02	33,37	35,8	39,5	51,8	65,2	71,8
bl1	49,2	1,13	0,62	0,68	1,19	22,24	18,4	20,2	63,1	52,8	58,0
bl2	49,2	1,13	0,62	0,68	1,19	22,13	18,3	20,1	63,0	52,7	57,9

NB: belastingen w_v gelden voor bundel

Project: RLL-TLB380
 Masttype: HA+0_c
 Mast: 1188

Auteur: TBR
 Versie: v12.0

Geleiderbelastingen

Uitgangspunten

Betrouwbaarheidsniveau Nieuwbouw CC2
 Referentieperiode 50 jaar

ULS (bezwijksterkte)		NEN-EN50341-2-15:2019							
Belastingsgeval	omschrijving	Temp °C	γ_G		γ_Q			γ_a A_k	
			$G_{k,mast}$	$G_{k,geleider}$	Q_{pk}	Q_{wk}	Q_{ik}		
ULS 1a	Wind	10°	1,20	1,20	0,00	1,50	0,00	0,0	
ULS 1a_0,9	Wind 0,9Gk alleen mast	10°	0,90	1,20	0,00	1,50	0,00	0,0	
ULS 1a_0,9_0,9	Wind 0,9Gk ook geleider	10°	0,90	0,90	0,00	1,50	0,00	0,0	
ULS 3	Wind+ijs	-5°	1,20	1,20	0,00	0,45	1,50	0,0	
ULS 3_0,9	Wind+ijs 0,9	-5°	0,90	1,20	0,00	0,45	1,50	0,0	
ULS 4	Koude+wind	-20°	1,20	1,20	0,00	0,30	0,00	0,0	
ULS 4_0,9	Koude+wind 0,9	-20°	0,90	1,20	0,00	0,30	0,00	0,0	
ULS 5a	Torsiebelastingen	10°	1,00	1,00	1,00	0,00	0,00	1,0	
ULS 5b	Longitudinale belastingen	10°	1,00	1,00	0,00	0,00	0,00	1,0	
ULS 6	Bouw en onderhoud	5°	1,20	1,20	1,50	0,30	0,00	0,0	
ULS 6_0,9	Bouw en onderhoud	5°	1,20	1,20	0,00	0,30	0,00	0,0	
ULS 7	Permanent	10°	1,35	1,35	0,00	0,00	0,00	0,0	
ULS 8	Special	10°	1,00	1,00	0,00	0,00	0,00	1,0	
SPLS (Bezwijksterkte, enkel voor hoekmasten: afwezigheid geleiders)				γ_G G_k	γ_Q Q_{pk} Q_{wk} Q_{ik}			A_k	
SPLS 1a	Wind	10°	1,20	1,20	0,0	0,78	0,00	0,0	
SPLS 1a_0,9	Wind 0,9	10°	0,90	1,20	0,0	0,78	0,00	0,0	
SPLS 1a_0,9_0,9	Wind 0,9	10°	0,90	0,90	0,0	0,78	0,00	0,0	
SPLS 3	Wind+ijs	-5°	1,20	1,20	0,0	0,36	0,34	0,0	
SPLS 3_0,9	Wind+ijs 0,9	-5°	0,90	1,20	0,0	0,36	0,34	0,0	
SPLS 4	Koude+wind	-20°	1,20	1,20	0,0	0,24	0,00	0,0	
SPLS 4_0,9	Koude+wind 0,9	-20°	0,90	1,20	0,0	0,24	0,00	0,0	
SPLS 6	Bouw en onderhoud	5°	1,20	1,20	1,2	0,24	0,0	0,0	
SPLS 6_0,9	Bouw en onderhoud	5°	1,20	1,20	0,0	0,24	0,0	0,0	
SLS (controle van de vervormingen, vermoeiing, EDS)				G_k	Q_{pk}	Q_{wk}	Q_{ik}	A_k	
SLS 1a	Wind	10°	1,00	1,00	0,0	1,00	0,0	0,0	
SLS 3	Wind+ijs	-5°	1,00	1,00	0,0	0,30	1,00	0,0	
SLS 4	Wind	-20°	1,00	1,00	0,0	0,20	0,0	0,0	
SLS 6	Bouw en onderhoud	5°	1,00	1,00	0,0	0,20	0,0	0,0	
SLS 7	PB (EDS, geen wind)	10°	1,00	1,00	0,0	0,00	0,0	0,0	

Aantal windrichtingen 6
 Aantal belastingcombinaties ULS 100
 Aantal belastingcombinaties SPLS 246
 Aantal belastingcombinaties SLS 15
 Aantal knooplasten 12274

Project: RLL-TLB380
 Masttype: HA+0_c
 Mast: 1188

Samenvattingstabellen geleiderbelastingen

In de onderstaande vier tabellen is weergegeven:

- De maximale geleiderbelasting in het globale assenstelsel, gesplitst in aandeel van back en ahead span
- De gecombineerde geleiderbelasting (Ba+Ah) in het globale assenstelsel met in het lokale assenstelsel de maximaal optredende trekkracht. Componenten Fx en Fy als absolute waarde
- De alledaagse (EDS) waarden van de gecombineerde geleiderbelastingen (Ba+Ah) met bijbehorende trekkrachten
- Controle op uplift, waar een negatieve waarde duidt op uplift

Maximale waarden voor back en ahead span

Geleider	Fx_ba [kN]	Fx_ah [kN]	Fy_ba [kN]	Fy_ah [kN]	Fz_ba [kN]	Fz_ah [kN]
bl1	-65,7	65,2	16,7	16,4	11,1	11,0
380ct1f1	-264,6	262,4	73,5	71,6	39,8	39,7
380ct1f2	-260,9	258,4	70,2	67,8	39,7	39,6
380ct1f3	-256,9	254,1	66,2	63,1	39,6	39,5
Post-isolato	0,0	0,0	0,0	0,0	0,0	
Post-isolato	0,0	0,0	0,0	0,0	0,0	
Post-isolato	0,0	0,0	0,0	0,0	0,0	
380ct2f1	-264,6	262,4	73,5	71,6	39,8	39,7
380ct2f2	-260,9	258,4	70,2	67,8	39,7	39,6
380ct2f3	-256,9	254,1	66,2	63,1	39,6	39,5
150ct3f1	-132,3	131,2	37,3	36,3	21,3	21,3
150ct3f2	-130,4	129,2	35,6	34,4	21,3	21,3
150ct3f3	-128,4	127,0	33,6	32,1	21,3	21,3
150ct4f1	-132,3	131,2	37,3	36,3	21,3	21,3
150ct4f2	-130,4	129,2	35,6	34,4	21,3	21,3
150ct4f3	-128,4	127,0	33,6	32,1	21,3	21,3
bl2	-64,8	64,3	16,5	16,2	11,0	10,9
Post-isolato	0,0	0,0	0,0	0,0	0,0	
Post-isolato	0,0	0,0	0,0	0,0	0,0	
Post-isolato	0,0	0,0	0,0	0,0	0,0	

Min. Weight span (m)

Weight spar Combinatie1

Geleider	SLS 1a	SLS 4	SLS 7
bl1	481,1	498,0	481,0
380ct1f1	481,1	496,4	481,0
380ct1f2	481,0	496,2	481,0
380ct1f3	481,0	495,8	481,0
Post-isolator 1			
Post-isolator 2			
Post-isolator 3			
380ct2f1	481,1	496,4	481,0
380ct2f2	481,0	496,2	481,0
380ct2f3	481,0	495,8	481,0
150ct3f1	481,1	496,4	481,0
150ct3f2	481,0	496,2	481,0
150ct3f3	481,0	495,8	481,0
150ct4f1	481,1	496,4	481,0
150ct4f2	481,0	496,2	481,0
150ct4f3	481,0	495,8	481,0
bl2	481,1	498,3	481,0
Post-isolator 4			
Post-isolator 5			
Post-isolator 6			

Max. Weight span (m)

Weight spar Combinatie1

Geleider	ULS 1a	ULS 3
bl1	575,0	464,1
380ct1f1	529,0	480,4
380ct1f2	524,0	479,3
380ct1f3	518,0	478,0
Post-isolator 1		
Post-isolator 2		
Post-isolator 3		
380ct2f1	529,0	480,4
380ct2f2	524,0	479,3
380ct2f3	518,0	478,0
150ct3f1	529,0	480,4
150ct3f2	524,0	479,3
150ct3f3	518,0	478,0
150ct4f1	529,0	480,4
150ct4f2	524,0	479,3
150ct4f3	518,0	478,0
bl2	577,5	463,7
Post-isolator 4		
Post-isolator 5		
Post-isolator 6		

Omhullende weight span over alle combinaties (incl. 0,9 combinaties)

Over alle geleiders	Wind / Weight span verhouding
Max. weight span	575,0 m 1,437 -
Min. weight span	93,3 m 0,233 -

Project: RLL-TLB380
 Masttype: HA+0_c
 Mast: 1188

Maximale waarden back+ahead span

Geleider	Maximale waarden back+ahead span		Maximale waarden trekkracht geleider		
	Fx [kN]	Fy [kN]	Fz [kN]	Ft_ba [kN]	Ft_ah [kN]
bl1	38,7	32,7	11,1	-67,6	67,1
380ct1f1	205,8	141,9	39,8	-271,5	269,2
380ct1f2	201,9	135,0	39,7	-267,5	264,9
380ct1f3	197,6	126,6	39,6	-263,3	260,2
Post-isolato	4,2	4,2	6,8	0,0	
Post-isolato	3,2	3,2	4,7	0,0	
Post-isolato	4,9	4,9	6,8	0,0	
380ct2f1	205,8	141,9	39,8	-271,5	269,2
380ct2f2	201,9	135,0	39,7	-267,5	264,9
380ct2f3	197,6	126,6	39,6	-263,3	260,2
150ct3f1	108,3	71,9	21,3	-135,8	134,6
150ct3f2	108,2	68,5	21,3	-133,8	132,4
150ct3f3	108,1	64,3	21,3	-131,6	130,1
150ct4f1	108,3	71,9	21,3	-135,8	134,6
150ct4f2	108,2	68,5	21,3	-133,8	132,4
150ct4f3	108,1	64,3	21,3	-131,6	130,1
bl2	38,2	32,3	11,0	-66,7	66,1
Post-isolato	4,2	4,2	6,8	0,0	
Post-isolato	3,2	3,2	4,7	0,0	
Post-isolato	4,9	4,9	6,8	0,0	

EDS-belastingen geleiders

Geleider	EDS-belastingen geleiders		Maximale waarden trekkracht geleider		
	Fx [kN]	Fy [kN]	Fz [kN]	Ft_ba [kN]	Ft_ah [kN]
bl1	17,0	3,0	2,4	-17,2	17,2
380ct1f1	129,3	22,8	20,5	-131,3	131,3
380ct1f2	129,3	22,8	20,5	-131,3	131,3
380ct1f3	129,3	22,8	20,5	-131,3	131,3
Post-isolato	0,0	0,0	5,0	0,0	
Post-isolato	0,0	0,0	3,5	0,0	
Post-isolato	0,0	0,0	5,0	0,0	
380ct2f1	129,3	22,8	20,5	-131,3	131,3
380ct2f2	129,3	22,8	20,5	-131,3	131,3
380ct2f3	129,3	22,8	20,5	-131,3	131,3
150ct3f1	64,7	11,4	10,8	-65,7	65,7
150ct3f2	64,7	11,4	10,8	-65,7	65,7
150ct3f3	64,7	11,4	10,8	-65,7	65,7
150ct4f1	64,7	11,4	10,8	-65,7	65,7
150ct4f2	64,7	11,4	10,8	-65,7	65,7
150ct4f3	64,7	11,4	10,8	-65,7	65,7
bl2	16,5	2,9	2,3	-16,8	16,8
Post-isolato	0,0	0,0	5,0	0,0	
Post-isolato	0,0	0,0	3,5	0,0	
Post-isolato	0,0	0,0	5,0	0,0	

Controle uplift SLS-wind

Combinatie: Geleider	Controle uplift SLS-wind	
	Fz_ba [kN]	Fz_ah [kN]
SLS 4 bl1	0,0	0,0
380ct1f1	0,0	0,0
380ct1f2	0,0	0,0
380ct1f3	0,0	0,0
Post-isolato	0,0	
Post-isolato	0,0	
Post-isolato	0,0	
380ct2f1	0,0	0,0
380ct2f2	0,0	0,0
380ct2f3	0,0	0,0
150ct3f1	0,0	0,0
150ct3f2	0,0	0,0
150ct3f3	0,0	0,0
150ct4f1	0,0	0,0
150ct4f2	0,0	0,0
150ct4f3	0,0	0,0
bl2	0,0	0,0
Post-isolato	0,0	
Post-isolato	0,0	
Post-isolato	0,0	

Project: RLL-TLB380
 Masttype: HA+0_c
 Mast: 1188

ULS-fundatiebelasting combinatie 1 en 3 wind haaks op de lijn of bissectrice en EDS, vanuit geleiders

Combinatie	Combination	F_x [kN]	F_y [kN]	F_z [kN]	M_x [kNm]	M_y [kNm]	M_z [kNm]
ULS 1a_90		-59	1294	531	50645	-2205	0
ULS 1a_0,9_0		27	490	336	18910	1051	0
ULS 1a_0,9_0,9_90		-65	1252	193	49061	-2426	0
ULS 3_0		9	806	788	31398	343	0
SLS 7		0	422	412	16292	0	0

ULS-fundatiebelasting combinatie 1 en 3 wind haaks op de lijn of bissectrice en EDS, totaal geleiders en mast

Combinatie	F_x [kN]	F_y [kN]	F_z [kN]	M_x [kNm]	M_y [kNm]	M_z [kNm]
ULS 1a_90	-59	1636	1702	60003	-2205	0
ULS 1a_0,9_0,9_90	-65	1595	1072	58419	-2426	0
SLS 7	0	422	1389	16292	0	0

Fundatiebelastingen, selectie belastingcombinaties op basis grootste waarde

Combinatie	F_x [kN]	F_y [kN]	F_z [kN]	M_x [kNm]	M_y [kNm]	M_z [kNm]
ULS 1a_0,9_90	-59	1636	1164	60004	-2205	0
SPLS 3_80 Ah All Cts	-1877	491	1509	18181	-73179	9
SPLS 3_80 Ba Ct1	895	666	1623	26158	34591	-9703
SPLS 3_0,9_80 Ah All Cts	-1877	491	1077	18181	-73179	9

Noot: grootste waarden kunnen in meerdere combinaties voorkomen, een combinatie is weergegeven.

Oplegreacties op fundering per randstijl

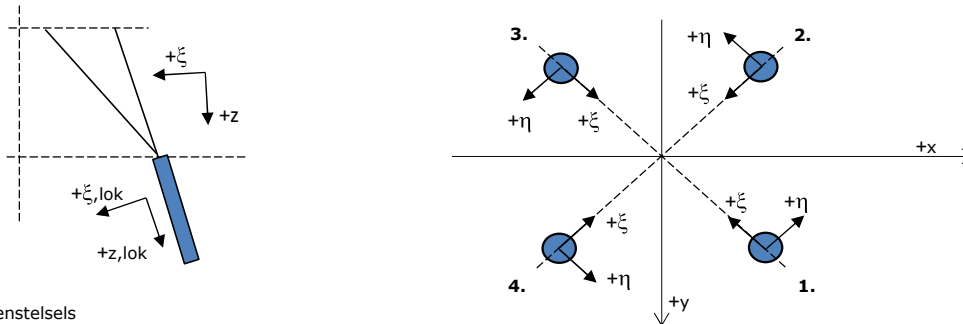

Assenstelsels

Maximale drukbelasting

Stijl	Combinatie	R_x [kN]	R_y [kN]	R_z [kN]	R_η [kN]	R_ξ [kN]	$R_{\xi,lok}$ [kN]	$R_{z,lok}$ [kN]
1	SPLS 3_100 Ba All Cts	701	842	4207	-100	-1090	40	4357
2	ULS 8 Ah	417	-613	2793	138	-728	22	2892
3	ULS 8 Ba	-417	-613	2793	-138	-728	22	2892
4	SPLS 3_80 Ah All Cts	-709	852	4261	101	-1104	41	4412

Maximale trekbelasting

Stijl	Combinatie	R_x [kN]	R_y [kN]	R_z [kN]	R_η [kN]	R_ξ [kN]	$R_{\xi,lok}$ [kN]	$R_{z,lok}$ [kN]
1	SPLS 3_0,9_90 Ah All Cts	-254	-472	-2074	154	513	-44	-2148
2	SPLS 3_0,9_80 Ah All Cts	-575	717	-3614	-100	913	-58	-3743
3	SPLS 3_0,9_100 Ba All Cts	563	703	-3547	99	895	-58	-3672
4	SPLS 3_0,9_0 Ba All Cts	284	-469	-2112	-131	532	-35	-2187

Maximale torsiebelasting (positief)

Stijl	Combinatie	R_x [kN]	R_y [kN]	R_z [kN]	R_η [kN]	R_ξ [kN]	$R_{\xi,lok}$ [kN]	$R_{z,lok}$ [kN]
1	SPLS 3_90 Ah Ct1	285	-277	-38	398	-6	-16	-39
2	SPLS 3_0,9_90 Ba Ct2	-134	-415	758	388	-199	5	785
3	SPLS 3_90 Ba Ct2	154	605	-2133	319	536	-37	-2209
4	SPLS 3_0,9_90 Ah Ct1	-329	761	2979	305	-771	29	3084

Maximale torsiebelasting (negatief)

Stijl	Combinatie	R_x [kN]	R_y [kN]	R_z [kN]	R_η [kN]	R_ξ [kN]	$R_{\xi,lok}$ [kN]	$R_{z,lok}$ [kN]
1	SPLS 3_0,9_90 Ba Ct1	315	752	2909	-309	-755	27	3012
2	SPLS 3_90 Ah Ct2	-166	615	-2198	-317	553	-38	-2276
3	SPLS 3_0,9_90 Ah Ct2	122	-422	817	-385	-212	7	846
4	SPLS 3_90 Ba Ct1	-296	-268	15	-399	-19	-15	16

Project: RLL-TLB380
 Masttype: HA+0_c
 Mast: 1188

Combinatie Ftrek+Fhor

Stijl	Combinatie	R _x [kN]	R _y [kN]	R _z [kN]	R _η [kN]	R _ξ [kN]	R _{ξ,lok} [kN]	R _{z,lok} [kN]
1	SPLS 3_0,9_90 Ah All Cts	-254	-472	-2074	154	513	-44	-2148
2	SPLS 3_0,9_80 Ah All Cts	-575	717	-3614	-100	913	-58	-3743
3	SPLS 3_0,9_100 Ba All Cts	563	703	-3547	99	895	-58	-3672
4	SPLS 3_0,9_0 Ba All Cts	284	-469	-2112	-131	532	-35	-2187

Permanente belasting

Stijl	Combinatie	R _x [kN]	R _y [kN]	R _z [kN]	R _η [kN]	R _ξ [kN]	R _{ξ,lok} [kN]	R _{z,lok} [kN]
1	SLS 7	217	178	1040	28	-280	0	1077
2	SLS 7	-72	33	-345	28	74	-18	-358
3	SLS 7	72	33	-345	-28	74	-18	-358
4	SLS 7	-217	178	1040	-28	-280	0	1077

Omhullenden ongeacht stijl

Belasting	Combinatie	R _x [kN]	R _y [kN]	R _z [kN]	R _η [kN]	R _ξ [kN]	R _{ξ,lok} [kN]	R _{z,lok} [kN]
Max. druk	SPLS 3_80 Ah All Cts	-709	852	4261	101	-1104	41	4412
Max. trek	SPLS 3_0,9_80 Ah All Cts	-575	717	-3614	-100	913	-58	-3743
Max. pos. torsie	SPLS 3_90 Ah Ct1	285	-277	-38	398	-6	-16	-39
Max. neg. torsie	SPLS 3_90 Ba Ct1	-296	-268	15	-399	-19	-15	16
Comb. trek+torsie	SPLS 3_0,9_80 Ah All Cts	-575	717	-3614	-100	913	-58	-3743

Maximale trekbelasting SLS

Stijl	Combinatie	R _x [kN]	R _y [kN]	R _z [kN]	R _η [kN]	R _ξ [kN]	R _{ξ,lok} [kN]	R _{z,lok} [kN]
1	SPLS 3_0,9_80 Ah All Cts	-251	-471	-2069	156	511	-45	-2142
2	SPLS 3_0,9_80 Ah All Cts	-575	717	-3614	-100	913	-58	-3743
3	SPLS 1a_0,9_100 Ba Ct2	231	609	-2340	267	594	-35	-2423
4	SPLS 3_0,9_100 Ba Ct2	151	108	-197	184	30	-22	-204

Maximale drukbelasting SLS

Stijl	Combinatie	R _x [kN]	R _y [kN]	R _z [kN]	R _η [kN]	R _ξ [kN]	R _{ξ,lok} [kN]	R _{z,lok} [kN]
1	SPLS 1a_100 Ba Ct2	722	398	2999	230	-792	14	3105
2	SPLS 3_100 Ba Ct2	-98	-440	927	380	-242	7	960
3	SPLS 3_80 Ah All Cts	-387	-606	2715	-155	-702	28	2811
4	SPLS 3_80 Ah All Cts	-709	852	4261	101	-1104	41	4412

Project: RLL-TLB380
Masttype: HA+0_c
Mast: 1188

Project: RLL-TLB380
Tower: HA+3_c
Number: 1094

Auteur: TBR
Versie: v12.0

Geleiderbelastingen

Algemeen

Benaming HA+3_c
Masttype Hoekmast
Aantal circuits 4
Configuratie 4-circuit-dubbel verticaal
Aantal bliksemgeleiders 2

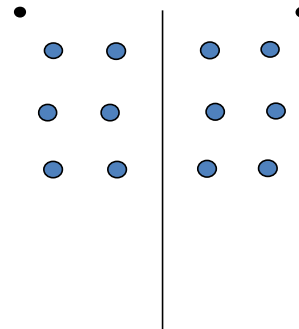

Configuratie geleiders

Uitgangspunten

Norm NEN-EN50341-2-15:2019
Gevolgklasse initieel CC2
Betrouwbaarheidsniveau initieel Nieuwbouw
Referentieperiode initieel 50 jaar
Betrouwbaarheidsniveau na aanpassing n.v.t.
50 jaar
Windgebied III
Windsnelheid (m/s) 24,5 m/s
Terreincategorie II
Reductiefactor C_{dir} 1,00
IJSgebied fasegeleider B
IJSgebied bliksemgeleider A

Geleiders Back

Omschrijving	Spanning	Geleider Back	Bundel Ba	IJSgebied	Toeslag gewicht	Toeslag diameter	Intrekwaarden P_{back}
Circuit 1	380 kV	AAAC-AL7 620	4	B	3 %	3 %	1800
Circuit 2	380 kV	AAAC-AL7 620	4	B	3 %	3 %	1800
Circuit 3	150 kV	AAAC-AL7 620	2	B	3 %	3 %	1800
Circuit 4	150 kV	AAAC-AL7 620	2	B	3 %	3 %	1800
Bliksemdraad 1		AACSR 241-AL3-39-A20SA	1	A	2 %	2 %	1800
Bliksemdraad 2		OPGW AFL-226/38	1	A	2 %	2 %	1800

Geleiders Ahead

Omschrijving	Spanning	Geleider Ahead	Bundel Ah	IJSgebied	Toeslag gewicht	Toeslag diameter	Intrekwaarden P_{ahead}
Circuit 1	380 kV	AAAC-AL7 620	4	B	3 %	3 %	1800
Circuit 2	380 kV	AAAC-AL7 620	4	B	3 %	3 %	1800
Circuit 3	150 kV	AAAC-AL7 620	2	B	3 %	3 %	1800
Circuit 4	150 kV	AAAC-AL7 620	2	B	3 %	3 %	1800
Bliksemdraad 1		AACSR 241-AL3-39-A20SA	1	A	2 %	2 %	1800
Bliksemdraad 2		OPGW AFL-226/38	1	A	2 %	2 %	1800

Isolatoren (1)

Omschrijving	Ophanging	Gewicht [kN]	Lengte [m]	Windopp. [m ²]
Circuit 1	Afspanketting	3,00	6,50	2,20
Circuit 2	Afspanketting	3,00	6,50	2,20
Circuit 3	Afspanketting	2,00	4,50	1,00
Circuit 4	Afspanketting	2,00	4,50	1,00
Bliksemdraad 1	Afspanketting	0,10	0,20	0,10
Bliksemdraad 2	Afspanketting	0,10	0,20	0,10

1. Eigenschappen gelden voor geheel van de isolatorset

Ophanghoogte en positie in mast

Circuits	Aanduiding	Nummer	Ophanghoogte	Aangrijppunt	Positie in mast Horizontale afstand
Circuit 1	10	380ct1f1	51,0 m	51,0 m	-10,8 m
Circuit 1	11	380ct1f2	41,0 m	41,0 m	-14,3 m
Circuit 1	12	380ct1f3	31,5 m	31,5 m	-11,4 m
Circuit 2	40	380ct2f1	51,0 m	51,0 m	10,8 m
Circuit 2	41	380ct2f2	41,0 m	41,0 m	14,3 m
Circuit 2	42	380ct2f3	31,5 m	31,5 m	11,4 m
Circuit 3	20	150ct3f1	51,0 m	51,0 m	-4,3 m
Circuit 3	21	150ct3f2	41,0 m	41,0 m	-7,8 m
Circuit 3	22	150ct3f3	31,5 m	31,5 m	-4,9 m
Circuit 4	30	150ct4f1	51,0 m	51,0 m	4,3 m
Circuit 4	31	150ct4f2	41,0 m	41,0 m	7,8 m
Circuit 4	32	150ct4f3	31,5 m	31,5 m	4,9 m
Bliksemdraad 1	1	bl1	56,1 m	56,1 m	-16,2 m
Bliksemdraad 2	3	bl2	56,1 m	56,1 m	16,2 m

Project: RLL-TLB380
 Tower: HA+3_c
 Number: 1094

Hoogteaanpassing naastgelegen masten (aanpassing wind- en weight span)

	Back	Ahead	
Verhoging voor windbelasting	15,0 m	6,0 m	(positief: omhoog)
Verlaging voor verticale belasting	-6,0 m	-6,0 m	(negatief: omlaag, grotere weight span)
Verlaging: Niet in 0,9EG-combinaties			

Hoogteafwijking mastbeeld naastgelegen masten en richtingsverandering t.o.v. Lijnrichting

Circuits	Aanduiding	Nummer	Hoogteverschil		Richtingsverandering	
			Δh back	Δh ahead	Δy back	Δy ahead
Circuit 1	10	380ct1f1	0,0	0,0 m	0,0	0,0 m
Circuit 1	11	380ct1f2	0,0	0,0 m	0,0	0,0 m
Circuit 1	12	380ct1f3	0,0	0,0 m	0,0	0,0 m
Circuit 2	40	380ct2f1	0,0	0,0 m	0,0	0,0 m
Circuit 2	41	380ct2f2	0,0	0,0 m	0,0	0,0 m
Circuit 2	42	380ct2f3	0,0	0,0 m	0,0	0,0 m
Circuit 3	20	150ct3f1	0,0	0,0 m	0,0	0,0 m
Circuit 3	21	150ct3f2	0,0	0,0 m	0,0	0,0 m
Circuit 3	22	150ct3f3	0,0	0,0 m	0,0	0,0 m
Circuit 4	30	150ct4f1	0,0	0,0 m	0,0	0,0 m
Circuit 4	31	150ct4f2	0,0	0,0 m	0,0	0,0 m
Circuit 4	32	150ct4f3	0,0	0,0 m	0,0	0,0 m
Bliksemdraad 1	1	bl1	0,0	0,0 m	0,0	0,0 m
Bliksemdraad 2	3	bl2	0,0	0,0 m	0,0	0,0 m

Lijn- en mastgegevens

	Back	Ahead
Ruling span $\sqrt{(\Sigma L^3)/\Sigma L}$	400,0	400,0 m
Lijnhoek β	160 °	
Rotatie mast t.o.v. bissectrice θ	0 °	
Vaklengte	400	400 m
Hoogte onderkant mast t.o.v. maaiveld	0,5 m	
Beschouwde windrichtingen	α_1	0 °
Windrichtingen volgens:	α_2	45 °
Geleiderbelastingen	α_3	90 °
	α_4	135 °
	α_5	80 °
	α_6	100 °

Windrichtingen gelden t.o.v. hoofdrichting mastconstructie, niet t.o.v. bissectrice.

Windrichtingen en positieve richtingen belastingen

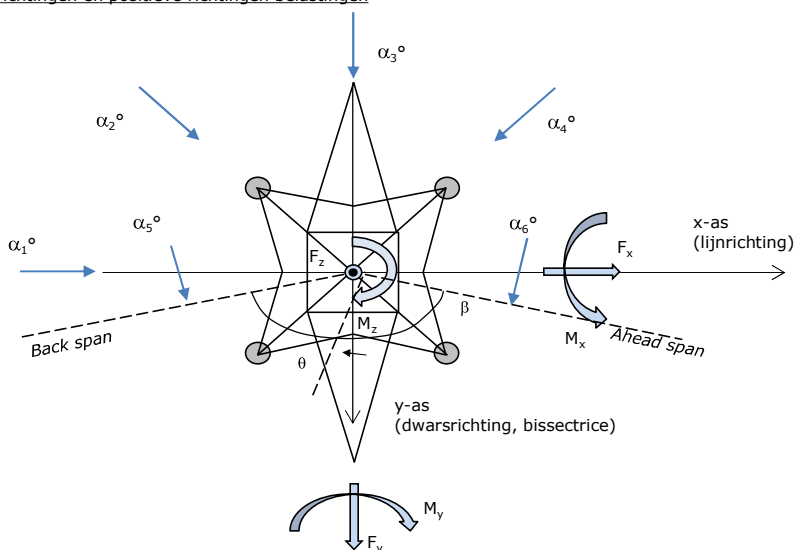

Beschouwd aantal windrichtingen

1a	6
3	6
4	1
6	1
Overig	1

Project: RLL-TLB380
 Tower: HA+3_c
 Number: 1094

Geleiderafval

		SPLS - torsie		SPLS - Enkelzijdige trek		5a - geleiderbreuk	
		Aanw.	Afw.	Aanw.	Afw.	Aanw.	Afw.
Circuit 1	380ct1f1	1	0	1	0	1	0
Circuit 1	380ct1f2	1	0	1	0	1	0
Circuit 1	380ct1f3	1	0	1	0	1	0
Circuit 2	380ct2f1	0	1	1	0	1	0
Circuit 2	380ct2f2	0	1	1	0	1	0
Circuit 2	380ct2f3	0	1	1	0	1	0
Circuit 3	150ct3f1	1	0	1	0	1	0
Circuit 3	150ct3f2	1	0	1	0	1	0
Circuit 3	150ct3f3	1	0	1	0	1	0
Circuit 4	150ct4f1	0	1	1	0	1	0
Circuit 4	150ct4f2	0	1	1	0	1	0
Circuit 4	150ct4f3	0	1	1	0	1	0
Bliksemdraad 1	b11	1	0	1	0	1	0
Bliksemdraad 2	b12	0	1	1	0	1	0

Belastingssituaties SPLS

Beschouwde situaties SPLS: 1 t/m 6, alle mogelijke situaties.

Principe belastingssituaties:

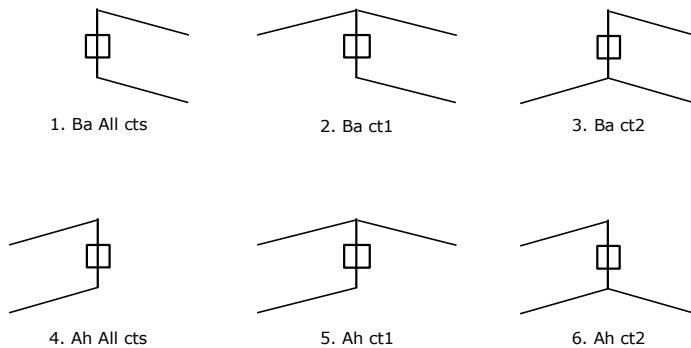

Belastingssituaties 5a. Geleiderbreuk

Beschouwde situaties geleiderbreuk 5a: 1 en 2, alle mogelijke situaties.

Principe belastingssituaties:

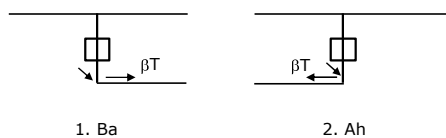

Project: RLL-TLB380
 Tower: HA+3_c
 Number: 1094

Belastingsituaties 6. Bouw- en onderhoud

Onder 6a wordt de belasting door aanwezigheid lijnwagen of lijnfiets in combinatie met puntlast op traverse in rekening gebracht. Combinatie 6b bevat geen belastingen in geleider of op traverse. Deze combinatie is toegevoegd om te kunnen combineren met separate controle bordessen etc. De situaties worden in ULS en in iedere SPLS-situatie (in geval van hoekmast) toegepast.

	Fase	Bliksem
Lijnwagen	4,0 kN	2,0 kN
Puntlast op traverse	1,0 kN	1,0 kN

Beschouwde situaties bouw- en onderhoud 6a: 1 t/m 4, alle mogelijke situaties.

Aanwezigheid lijnwagen: Circuit, belasting tegelijk aanwezig in alle geleiders per circuit.

Principe belastingssituaties:

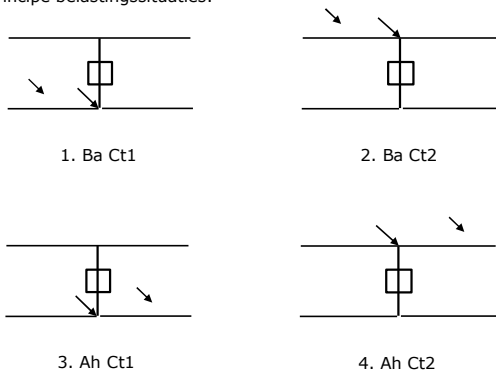

Belastingsituaties 8. Lijndansen als statische belasting

Geleider		
Steunmast fase	0,866 W	1,5 W
Steunmast bliksem	1,5 EDS	1,5 W
Hoekmast fase en bliksem	1,5 EDS	1,5 W

Beschouwde situaties lijndansen 8: 1 en 2, alle mogelijke situaties.

Belasting tegelijk aanwezig in alle geleiders van het circuit.

Principe belastingssituaties:

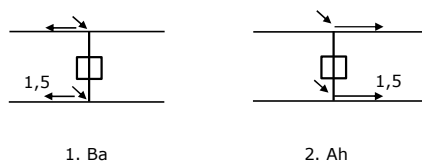

Belastingcombinatie 8. Lijndansen als dynamische belasting

Alleen van toepassing op hoek- en eindmasten

Belasting bestaat uit EDS-trekbelasting in één van de geleiders aan één zijde van de mast

Door gebruiker via het belastingsspectrum van tabel 4.11/NL.1 om te zetten naar spanningspectrum

Project: RLL-TLB380
 Tower: HA+3_c
 Number: 1094

Mastconstructie

Eigenschappen

Masttype	Hoekmast	
Mastbenaming	HA+3_c	
Voetplaat t.o.v. maaiveld	0,5 m	
Masthoogte t.o.v. voetplaat	56,1 m	
Gewicht mast	1049,8 kN	
<i>Breedte en helling mast bij fundatie</i>		
	x-ri.	y-ri.
Pootsprei	12,90	12,90 m
Helling van de randstijl	0,190	0,190 -
Factor spatkracht	1,1	1,1 -

Berekening windbelasting

Dynamische invloed G_T	1,00 (<i>Masthoogte < 60 m</i>)
Windbelasting overhoeks op mastlichaam evenredig met:	$(A1C1\sin^2(\phi)+A2C2\cos^2(\phi))$
Windbelasting overhoeks op traverse evenredig met:	$(A1C1\sin^2(\phi)+A2C2\cos^2(\phi))$
Vergroting wind overhoeks mastlichaam	$(1+0,2\sin^2(2\phi))$
Vergroting wind overhoeks traverse	$(1+0,2\sin^2(2\phi))$
Factor wind evenwijdig t.o.v. haaks op traverse	0,4

Eigenschappen mastsecties langsrichting (vooraanzicht, yz-vlak)

Omschrijving	h [m]	b ₁ [m]	b ₂ [m]	Δh [m]	Δ _x [m]	A ₀ [m ²]	A ₁ [m ²]	χ = A ₁ /A ₀ [-]	C _t
Broekstuk	18,40	12,90	5,91	18,40	0,190	173,07	39,79	0,23	2,80
Eerste tussenstuk	25,20	5,91	5,23	6,80	0,050	37,88	13,24	0,35	2,37
Tweede tussenstuk	31,50	5,23	4,60	6,30	0,050	30,96	10,25	0,33	2,43
Bovenstuk 1	41,00	4,60	3,65	9,50	0,050	39,19	11,88	0,30	2,52
Bovenstuk 2	54,40	3,65	2,31	13,40	0,050	39,93	13,01	0,33	2,45
Topstuk	56,10	2,31		1,70		1,96	0,33	0,17	3,08
Ondertraverse	31,50	9,40		3,10		14,57	4,37	0,30	2,54
Middentraverse	41,00	12,78		3,20		20,45	6,34	0,31	2,50
Boventraverse	51,00	14,88		5,10		37,93	7,34	0,19	2,96

Eigenschappen mastsecties dwarsrichting (zijaanzicht, xz-vlak)

Omschrijving	h [m]	b ₁ [m]	b ₂ [m]	Δh [m]	Δ _x [m]	A ₀ [m ²]	A ₁ [m ²]	χ = A ₁ /A ₀ [-]	C _t
Broekstuk	18,40	12,90	5,91	18,40	0,190	173,07	39,79	0,23	2,80
Eerste tussenstuk	25,20	5,91	5,23	6,80	0,050	37,88	13,24	0,35	2,37
Tweede tussenstuk	31,50	5,23	4,60	6,30	0,050	30,96	10,25	0,33	2,43
Bovenstuk 1	41,00	4,60	3,65	9,50	0,050	39,19	11,88	0,30	2,52
Bovenstuk 2	54,40	3,65	2,31	13,40	0,050	39,93	13,01	0,33	2,45
Topstuk	56,10	2,31		1,70		1,96	0,33	0,17	3,08
Ondertraverse	31,50	9,40		3,10		14,57	4,37	0,30	2,54
Middentraverse	41,00	12,78		3,20		20,45	6,34	0,31	2,50
Boventraverse	51,00	14,88		5,10		37,93	7,34	0,19	2,96

NB: oppervlakte traverse dwarsrichting van de tabel wordt in berekening gereduceerd.
 NB: oppervlakte traverse per zijde, dus helft van totaal van twee traveres.

Project: RLL-TLB380
 Tower: HA+3_c
 Number: 1094

Windoppervlak feeders telecominstallaties

Onderdeel	A (m ² /m)	Factor	Δh	A ₁
Broekstuk	0,14	0,71	18,4	1,8
Eerste tussenstuk	0,14	0,71	6,8	0,7
Tweede tussenstuk	0,14	0,71	6,3	0,6
Bovenstuk 1	0,14	0,71	9,5	0,9
Bovenstuk 2				

Invoer antennes

Omschrijving	A (m ²)	h (m)	C _i (m)
Antenne top			
Antenne o.t.	4,7	37,7	1,5

Belastingen mastsectie langsrichting (x-richting) per windrichting

Omschrijving	P _w [kN/m ²]	F _{x1} [kN]	F _{x2} [kN]	F _{x3} [kN]	F _{x4} [kN]	h _{ef} [m]	M _{y1} [kNm]	M _{y2} [kNm]	M _{y3} [kNm]	M _{y4} [kNm]
Broekstuk	0,70	78,2	66,4	0,0	-66,4	9,2	719,6	610,6	0,0	-610,6
Eerste tussenstuk	0,90	28,2	24,0	0,0	-24,0	21,8	615,6	522,3	0,0	-522,3
Tweede tussenstuk	0,97	24,2	20,5	0,0	-20,5	28,4	686,2	582,3	0,0	-582,3
Bovenstuk 1	1,05	31,4	26,6	0,0	-26,6	36,3	1136,7	964,5	0,0	-964,5
Bovenstuk 2	1,12	35,7	30,3	0,0	-30,3	47,7	1701,8	1444,0	0,0	-1444,0
Topstuk	1,17	1,2	1,0	0,0	-1,0	55,3	65,2	55,3	0,0	-55,3
Ondertraverse	1,01	22,4	13,3	0,0	-13,3	32,5	728,4	432,7	0,0	-432,7
Middentraverse	1,08	34,4	20,4	0,0	-20,4	42,1	1446,5	859,2	0,0	-859,2
Boventraverse	1,15	50,0	29,7	0,0	-29,7	52,7	2635,4	1565,3	0,0	-1565,3
Totaal		305,7	232,2	0,0	-232,2		9735,3	7036,1	0,0	-7036,1

Belastingen mastsectie dwarsrichting (y-richting) per windrichting

Omschrijving	P _w [kN/m ²]	F _{y1} [kN]	F _{y2} [kN]	F _{y3} [kN]	F _{y4} [kN]	h _{ef} [m]	M _{x1} [kNm]	M _{x2} [kNm]	M _{x3} [kNm]	M _{x4} [kNm]
Broekstuk	0,70	0,0	66,4	78,2	66,4	9,2	0,0	610,6	719,6	610,6
Eerste tussenstuk	0,90	0,0	24,0	28,2	24,0	21,8	0,0	522,3	615,6	522,3
Tweede tussenstuk	0,97	0,0	20,5	24,2	20,5	28,4	0,0	582,3	686,2	582,3
Bovenstuk 1	1,05	0,0	26,6	31,4	26,6	36,3	0,0	964,5	1136,7	964,5
Bovenstuk 2	1,12	0,0	30,3	35,7	30,3	47,7	0,0	1444,0	1701,8	1444,0
Topstuk	1,17	0,0	1,0	1,2	1,0	55,3	0,0	55,3	65,2	55,3
Ondertraverse	1,01	0,0	13,3	9,0	13,3	32,5	0,0	432,7	291,4	432,7
Middentraverse	1,08	0,0	20,4	13,8	20,4	42,1	0,0	859,2	578,6	859,2
Boventraverse	1,15	0,0	29,7	20,0	29,7	52,7	0,0	1565,3	1054,1	1565,3
Totaal		0,0	232,2	241,6	232,2		0,0	7036,1	6849,1	7036,1

Resulterende belastingen vanuit mastconstructie incl. antenne zonder geleiders niveau fundatie (kar. waarde)

Belasting / windrichting	F _x [kN]	F _y [kN]	F _z [kN]	M _x [kNm]	M _y [kNm]	M _z [kNm]
Permanente belasting	0	0	1050	0	0	0
Windrichting 0°	313	0	0	0	10015	0
Windrichting 45°	237	237	0	7234	7234	0
Windrichting 90°	0	249	0	7129	0	0
Windrichting 135°	-237	237	0	7234	-7234	0

Project: RLL-TLB380
 Tower: HA+3_c
 Number: 1094

Tussenresultaten geleiderbelastingen

Geleiders back

Circuit	Geleider	Diameter [mm]	A [mm ²]	G [N/m]	E [N/mm ²]	αT [-]
Circuit 1	AAAC-AL7 620	32,4	621,0	17,71	56000	2,30E-05
Circuit 2	AAAC-AL7 620	32,4	621,0	17,71	56000	2,30E-05
Circuit 3	AAAC-AL7 620	32,4	621,0	17,71	56000	2,30E-05
Circuit 4	AAAC-AL7 620	32,4	621,0	17,71	56000	2,30E-05
Bliksemdraad 1	AACSR 241-AL3-39-A20SA	21,8	281,0	9,38	70165	1,97E-05
Bliksemdraad 2	OPGW AFL-226/38	21,7	264,0	9,13	72000	1,98E-05

Geleiders ahead

Circuit	Geleider	Diameter [mm]	A [mm ²]	G [N/m]	E [N/mm ²]	αT [-]
Circuit 1	AAAC-AL7 620	32,4	621,0	17,71	56000	2,30E-05
Circuit 2	AAAC-AL7 620	32,4	621,0	17,71	56000	2,30E-05
Circuit 3	AAAC-AL7 620	32,4	621,0	17,71	56000	2,30E-05
Circuit 4	AAAC-AL7 620	32,4	621,0	17,71	56000	2,30E-05
Bliksemdraad 1	AACSR 241-AL3-39-A20SA	21,8	281,0	9,38	70165	1,97E-05
Bliksemdraad 2	OPGW AFL-226/38	21,7	264,0	9,13	72000	1,98E-05

Verticale belasting back

Circuit	Bundel [-]	Toeslag [%]	$W_{z,G}$ [N/m]	IJsgebied	Formule	$W_{z,ijs}$ [N/m]	$W_{z,ijs,bundel}$ [N/m]
Circuit 1	4	3	73,0	B	4+0,2d	10,5	41,9
Circuit 2	4	3	73,0	B	4+0,2d	10,5	41,9
Circuit 3	2	3	36,5	B	4+0,2d	10,5	21,0
Circuit 4	2	3	36,5	B	4+0,2d	10,5	21,0
Bliksemdraad 1	1	2	9,6	A	15+0,4d	23,7	23,7
Bliksemdraad 2	1	2	9,3	A	15+0,4d	23,7	23,7

Verticale belasting ahead

Circuit	Bundel [-]	Toeslag [%]	$W_{z,G}$ [N/m]	IJsgebied	Formule	$W_{z,ijs}$ [N/m]	$W_{z,ijs,bundel}$ [N/m]
Circuit 1	4	3	73,0	B	4+0,2d	10,5	41,9
Circuit 2	4	3	73,0	B	4+0,2d	10,5	41,9
Circuit 3	2	3	36,5	B	4+0,2d	10,5	21,0
Circuit 4	2	3	36,5	B	4+0,2d	10,5	21,0
Bliksemdraad 1	1	2	9,6	A	15+0,4d	23,7	23,7
Bliksemdraad 2	1	2	9,3	A	15+0,4d	23,7	23,7

Isolatoren

Geleider	$G_{isolator}$ [kN]	Aantal	$F_{v,iso}$ [kN]	Lengte [m]	Windopp. [m ²]	Windhoogte [m]	Stuwdruk [kN/m ²]	Vormfactor [-]	$F_{h,iso}$ [kN]
380ct1f1	3,00	1	3	6,5	2,2	51,50	1,14	1,2	3,02
380ct1f2	3,00	1	3	6,5	2,2	41,50	1,08	1,2	2,85
380ct1f3	3,00	1	3	6,5	2,2	32,00	1,01	1,2	2,66
380ct2f1	3,00	1	3	6,5	2,2	51,50	1,14	1,2	3,02
380ct2f2	3,00	1	3	6,5	2,2	41,50	1,08	1,2	2,85
380ct2f3	3,00	1	3	6,5	2,2	32,00	1,01	1,2	2,66
150ct3f1	2,00	1	2	4,5	1,0	51,50	1,14	1,2	1,37
150ct3f2	2,00	1	2	4,5	1,0	41,50	1,08	1,2	1,30
150ct3f3	2,00	1	2	4,5	1,0	32,00	1,01	1,2	1,21
150ct4f1	2,00	1	2	4,5	1,0	51,50	1,14	1,2	1,37
150ct4f2	2,00	1	2	4,5	1,0	41,50	1,08	1,2	1,30
150ct4f3	2,00	1	2	4,5	1,0	32,00	1,01	1,2	1,21
bl1	0,10	1	0,1	0,2	0,1	56,60	1,17	1,2	0,14
bl2	0,10	1	0,1	0,2	0,1	56,60	1,17	1,2	0,14

Project: RLL-TLB380
 Tower: HA+3_c
 Number: 1094

Windbelasting back

Geleider	hoogte		G_{c_dwars}	G_{c_trek}	C_c	$d_{toeslag}$	w_y	$w_{y,vak}$	$D_{ijs,toeslag}$	$w_{y,ijs}$	$w_{y,ijs,vak}$
	wind	Stuwdruk									
	[m]	[kN/m ²]	[-]	[-]	[-]	[mm]	[N/m]	[N/m]	[mm]	[N/m]	[N/m]
380ct1f1	51,6	1,14	0,62	0,68	0,96	33,37	90,6	99,6	51,8	176,5	194,1
380ct1f2	41,6	1,08	0,60	0,66	0,98	33,37	85,0	93,5	51,8	162,2	178,5
380ct1f3	32,1	1,01	0,58	0,64	1,00	33,37	78,3	86,2	51,8	146,0	160,7
380ct2f1	51,6	1,14	0,62	0,68	0,96	33,37	90,6	99,6	51,8	176,5	194,1
380ct2f2	41,6	1,08	0,60	0,66	0,98	33,37	85,0	93,5	51,8	162,2	178,5
380ct2f3	32,1	1,01	0,58	0,64	1,00	33,37	78,3	86,2	51,8	146,0	160,7
150ct3f1	51,6	1,14	0,62	0,68	0,96	33,37	45,3	49,8	51,8	88,3	97,0
150ct3f2	41,6	1,08	0,60	0,66	0,98	33,37	42,5	46,7	51,8	81,1	89,2
150ct3f3	32,1	1,01	0,58	0,64	1,00	33,37	39,2	43,1	51,8	73,0	80,4
150ct4f1	51,6	1,14	0,62	0,68	0,96	33,37	45,3	49,8	51,8	88,3	97,0
150ct4f2	41,6	1,08	0,60	0,66	0,98	33,37	42,5	46,7	51,8	81,1	89,2
150ct4f3	32,1	1,01	0,58	0,64	1,00	33,37	39,2	43,1	51,8	73,0	80,4
bl1	56,7	1,17	0,63	0,69	1,18	22,24	19,3	21,2	63,1	55,7	61,2
bl2	56,7	1,17	0,63	0,69	1,18	22,13	19,2	21,1	63,0	55,6	61,2

Windbelasting ahead

Geleider	hoogte		G_{c_dwars}	G_{c_trek}	C_c	$d_{toeslag}$	w_y	$w_{y,vak}$	$D_{ijs,toeslag}$	$w_{y,ijs}$	$w_{y,ijs,vak}$
	wind	Stuwdruk									
	[m]	[kN/m ²]	[-]	[-]	[-]	[mm]	[N/m]	[N/m]	[mm]	[N/m]	[N/m]
380ct1f1	47,1	1,12	0,61	0,67	0,96	33,37	88,2	97,0	51,8	170,4	187,4
380ct1f2	37,1	1,05	0,59	0,65	0,99	33,37	82,0	90,3	51,8	155,0	170,5
380ct1f3	27,6	0,97	0,57	0,63	1,01	33,37	74,5	82,0	51,8	137,1	150,9
380ct2f1	47,1	1,12	0,61	0,67	0,96	33,37	88,2	97,0	51,8	170,4	187,4
380ct2f2	37,1	1,05	0,59	0,65	0,99	33,37	82,0	90,3	51,8	155,0	170,5
380ct2f3	27,6	0,97	0,57	0,63	1,01	33,37	74,5	82,0	51,8	137,1	150,9
150ct3f1	47,1	1,12	0,61	0,67	0,96	33,37	44,1	48,5	51,8	85,2	93,7
150ct3f2	37,1	1,05	0,59	0,65	0,99	33,37	41,0	45,1	51,8	77,5	85,3
150ct3f3	27,6	0,97	0,57	0,63	1,01	33,37	37,3	41,0	51,8	68,5	75,5
150ct4f1	47,1	1,12	0,61	0,67	0,96	33,37	44,1	48,5	51,8	85,2	93,7
150ct4f2	37,1	1,05	0,59	0,65	0,99	33,37	41,0	45,1	51,8	77,5	85,3
150ct4f3	27,6	0,97	0,57	0,63	1,01	33,37	37,3	41,0	51,8	68,5	75,5
bl1	52,2	1,15	0,62	0,68	1,18	22,24	18,7	20,6	63,1	54,0	59,4
bl2	52,2	1,15	0,62	0,68	1,18	22,13	18,7	20,5	63,0	53,9	59,3

NB: belastingen w_v gelden voor bundel

Project: RLL-TLB380
 Masttype: HA+3_c
 Mast: 1094

Auteur: TBR
 Versie: v12.0

Geleiderbelastingen

Uitgangspunten

Betrouwbaarheidsniveau Nieuwbouw CC2
 Referentieperiode 50 jaar

ULS (bezwijksterkte)		NEN-EN50341-2-15:2019							
Belastingsgeval	omschrijving	Temp °C	γ_G		γ_Q			γ_a A_k	
			$G_{k,mast}$	$G_{k,geleider}$	Q_{pk}	Q_{wk}	Q_{ik}		
ULS 1a	Wind	10°	1,20	1,20	0,00	1,50	0,00	0,0	
ULS 1a_0,9	Wind 0,9Gk alleen mast	10°	0,90	1,20	0,00	1,50	0,00	0,0	
ULS 1a_0,9_0,9	Wind 0,9Gk ook geleider	10°	0,90	0,90	0,00	1,50	0,00	0,0	
ULS 3	Wind+ijs	-5°	1,20	1,20	0,00	0,45	1,50	0,0	
ULS 3_0,9	Wind+ijs 0,9	-5°	0,90	1,20	0,00	0,45	1,50	0,0	
ULS 4	Koude+wind	-20°	1,20	1,20	0,00	0,30	0,00	0,0	
ULS 4_0,9	Koude+wind 0,9	-20°	0,90	1,20	0,00	0,30	0,00	0,0	
ULS 5a	Torsiebelastingen	10°	1,00	1,00	1,00	0,00	0,00	1,0	
ULS 5b	Longitudinale belastingen	10°	1,00	1,00	0,00	0,00	0,00	1,0	
ULS 6	Bouw en onderhoud	5°	1,20	1,20	1,50	0,30	0,00	0,0	
ULS 6_0,9	Bouw en onderhoud	5°	1,20	1,20	0,00	0,30	0,00	0,0	
ULS 7	Permanent	10°	1,35	1,35	0,00	0,00	0,00	0,0	
ULS 8	Special	10°	1,00	1,00	0,00	0,00	0,00	1,0	
SPLS (Bezwijksterkte, enkel voor hoekmasten: afwezigheid geleiders)				γ_G G_k	γ_Q Q_{pk} Q_{wk} Q_{ik}			A_k	
SPLS 1a	Wind	10°	1,20	1,20	0,0	0,78	0,00	0,0	
SPLS 1a_0,9	Wind 0,9	10°	0,90	1,20	0,0	0,78	0,00	0,0	
SPLS 1a_0,9_0,9	Wind 0,9	10°	0,90	0,90	0,0	0,78	0,00	0,0	
SPLS 3	Wind+ijs	-5°	1,20	1,20	0,0	0,36	0,34	0,0	
SPLS 3_0,9	Wind+ijs 0,9	-5°	0,90	1,20	0,0	0,36	0,34	0,0	
SPLS 4	Koude+wind	-20°	1,20	1,20	0,0	0,24	0,00	0,0	
SPLS 4_0,9	Koude+wind 0,9	-20°	0,90	1,20	0,0	0,24	0,00	0,0	
SPLS 6	Bouw en onderhoud	5°	1,20	1,20	1,2	0,24	0,0	0,0	
SPLS 6_0,9	Bouw en onderhoud	5°	1,20	1,20	0,0	0,24	0,0	0,0	
SLS (controle van de vervormingen, vermoeiing, EDS)				G_k	Q_{pk}	Q_{wk}	Q_{ik}	A_k	
SLS 1a	Wind	10°	1,00	1,00	0,0	1,00	0,0	0,0	
SLS 3	Wind+ijs	-5°	1,00	1,00	0,0	0,30	1,00	0,0	
SLS 4	Wind	-20°	1,00	1,00	0,0	0,20	0,0	0,0	
SLS 6	Bouw en onderhoud	5°	1,00	1,00	0,0	0,20	0,0	0,0	
SLS 7	PB (EDS, geen wind)	10°	1,00	1,00	0,0	0,00	0,0	0,0	

Aantal windrichtingen 6
 Aantal belastingcombinaties ULS 100
 Aantal belastingcombinaties SPLS 246
 Aantal belastingcombinaties SLS 15
 Aantal knooplasten 12274

Project: RLL-TLB380
 Masttype: HA+3_c
 Mast: 1094

Samenvattingstabellen geleiderbelastingen

In de onderstaande vier tabellen is weergegeven:

- De maximale geleiderbelasting in het globale assenstelsel, gesplitst in aandeel van back en ahead span
- De gecombineerde geleiderbelasting (Ba+Ah) in het globale assenstelsel met in het lokale assenstelsel de maximaal optredende trekkracht. Componenten Fx en Fy als absolute waarde
- De alledaagse (EDS) waarden van de gecombineerde geleiderbelastingen (Ba+Ah) met bijbehorende trekkrachten
- Controle op uplift, waar een negatieve waarde duidt op uplift

Maximale waarden voor back en ahead span

Geleider	Fx_ba [kN]	Fx_ah [kN]	Fy_ba [kN]	Fy_ah [kN]	Fz_ba [kN]	Fz_ah [kN]
bl1	-65,8	65,5	16,8	16,5	10,5	10,5
380ct1f1	-265,0	263,4	76,2	74,9	37,8	37,7
380ct1f2	-261,3	259,5	73,0	71,3	37,7	37,7
380ct1f3	-257,4	255,4	69,2	67,0	37,6	37,6
Post-isolato	0,0	0,0	0,0	0,0	0,0	
Post-isolato	0,0	0,0	0,0	0,0	0,0	
Post-isolato	0,0	0,0	0,0	0,0	0,0	
380ct2f1	-265,0	263,4	76,2	74,9	37,8	37,7
380ct2f2	-261,3	259,5	73,0	71,3	37,7	37,7
380ct2f3	-257,4	255,4	69,2	67,0	37,6	37,6
150ct3f1	-132,5	131,7	37,9	37,2	20,4	20,4
150ct3f2	-130,7	129,8	36,3	35,5	20,4	20,4
150ct3f3	-128,7	127,7	34,4	33,3	20,4	20,4
150ct4f1	-132,5	131,7	37,9	37,2	20,4	20,4
150ct4f2	-130,7	129,8	36,3	35,5	20,4	20,4
150ct4f3	-128,7	127,7	34,4	33,3	20,4	20,4
bl2	-64,9	64,5	16,6	16,4	10,5	10,5
Post-isolato	0,0	0,0	0,0	0,0	0,0	
Post-isolato	0,0	0,0	0,0	0,0	0,0	
Post-isolato	0,0	0,0	0,0	0,0	0,0	

Min. Weight span (m)

Weight spar Combinatie1

Geleider	SLS 1a	SLS 4	SLS 7
bl1	454,1	465,5	454,0
380ct1f1	454,0	464,3	454,0
380ct1f2	454,0	464,1	454,0
380ct1f3	454,0	463,9	454,0
Post-isolator 1			
Post-isolator 2			
Post-isolator 3			
380ct2f1	454,0	464,3	454,0
380ct2f2	454,0	464,1	454,0
380ct2f3	454,0	463,9	454,0
150ct3f1	454,0	464,3	454,0
150ct3f2	454,0	464,1	454,0
150ct3f3	454,0	463,9	454,0
150ct4f1	454,0	464,3	454,0
150ct4f2	454,0	464,1	454,0
150ct4f3	454,0	463,9	454,0
bl2	454,1	465,7	454,0
Post-isolator 4			
Post-isolator 5			
Post-isolator 6			

Max. Weight span (m)

Weight spar Combinatie1

Geleider	ULS 1a	ULS 3
bl1	517,7	442,8
380ct1f1	486,6	453,8
380ct1f2	483,5	453,0
380ct1f3	479,8	452,2
Post-isolator 1		
Post-isolator 2		
Post-isolator 3		
380ct2f1	486,6	453,8
380ct2f2	483,5	453,0
380ct2f3	479,8	452,2
150ct3f1	486,6	453,8
150ct3f2	483,5	453,0
150ct3f3	479,8	452,2
150ct4f1	486,6	453,8
150ct4f2	483,5	453,0
150ct4f3	479,8	452,2
bl2	519,4	442,6
Post-isolator 4		
Post-isolator 5		
Post-isolator 6		

Omhullende weight span over alle combinaties (incl. 0,9 combinaties)

Wind / Weight span verhouding	
Max. weight span	517,7 m
Min. weight span	130,0 m
	1,294 -
	0,325 -

Project: RLL-TLB380
 Masttype: HA+3_c
 Mast: 1094

Maximale waarden back+ahead span Maximale waarden trekkracht geleider

Geleider	Fx [kN]	Fy [kN]	Fz [kN]	Ft_ba [kN]	Ft_ah [kN]
bl1	39,0	32,9	10,5	-67,7	67,3
380ct1f1	206,2	147,7	37,8	-272,1	270,4
380ct1f2	202,4	141,1	37,7	-268,2	266,2
380ct1f3	198,3	133,3	37,6	-264,0	261,8
Post-isolato	4,3	4,3	6,8	0,0	
Post-isolato	3,3	3,3	4,7	0,0	
Post-isolato	4,9	4,9	6,8	0,0	
380ct2f1	206,2	147,7	37,8	-272,1	270,4
380ct2f2	202,4	141,1	37,7	-268,2	266,2
380ct2f3	198,3	133,3	37,6	-264,0	261,8
150ct3f1	108,3	73,5	20,4	-136,1	135,2
150ct3f2	108,2	70,2	20,4	-134,1	133,1
150ct3f3	108,1	66,3	20,4	-132,0	130,9
150ct4f1	108,3	73,5	20,4	-136,1	135,2
150ct4f2	108,2	70,2	20,4	-134,1	133,1
150ct4f3	108,1	66,3	20,4	-132,0	130,9
bl2	38,4	32,5	10,5	-66,8	66,4
Post-isolato	4,3	4,3	6,8	0,0	
Post-isolato	3,3	3,3	4,7	0,0	
Post-isolato	4,9	4,9	6,8	0,0	

EDS-belastingen geleiders

Geleider	Fx [kN]	Fy [kN]	Fz [kN]	Ft_ba [kN]	Ft_ah [kN]
bl1	17,0	3,0	2,3	-17,2	17,2
380ct1f1	129,3	22,8	19,6	-131,3	131,3
380ct1f2	129,3	22,8	19,6	-131,3	131,3
380ct1f3	129,3	22,8	19,6	-131,3	131,3
Post-isolato	0,0	0,0	5,0	0,0	
Post-isolato	0,0	0,0	3,5	0,0	
Post-isolato	0,0	0,0	5,0	0,0	
380ct2f1	129,3	22,8	19,6	-131,3	131,3
380ct2f2	129,3	22,8	19,6	-131,3	131,3
380ct2f3	129,3	22,8	19,6	-131,3	131,3
150ct3f1	64,7	11,4	10,3	-65,7	65,7
150ct3f2	64,7	11,4	10,3	-65,7	65,7
150ct3f3	64,7	11,4	10,3	-65,7	65,7
150ct4f1	64,7	11,4	10,3	-65,7	65,7
150ct4f2	64,7	11,4	10,3	-65,7	65,7
150ct4f3	64,7	11,4	10,3	-65,7	65,7
bl2	16,5	2,9	2,2	-16,8	16,8
Post-isolato	0,0	0,0	5,0	0,0	
Post-isolato	0,0	0,0	3,5	0,0	
Post-isolato	0,0	0,0	5,0	0,0	

Controle uplift SLS-wind

Combinatie: Geleider	Fz_ba [kN]	Fz_ah [kN]
SLS 4 bl1	0,0	0,0
380ct1f1	0,0	0,0
380ct1f2	0,0	0,0
380ct1f3	0,0	0,0
Post-isolato	0,0	
Post-isolato	0,0	
Post-isolato	0,0	
380ct2f1	0,0	0,0
380ct2f2	0,0	0,0
380ct2f3	0,0	0,0
150ct3f1	0,0	0,0
150ct3f2	0,0	0,0
150ct3f3	0,0	0,0
150ct4f1	0,0	0,0
150ct4f2	0,0	0,0
150ct4f3	0,0	0,0
bl2	0,0	0,0
Post-isolato	0,0	
Post-isolato	0,0	
Post-isolato	0,0	

Project: RLL-TLB380
 Masttype: HA+3_c
 Mast: 1094

ULS-fundatiebelasting combinatie 1 en 3 wind haaks op de lijn of bissectrice en EDS, vanuit geleiders

Combinatie	Combination	F_x [kN]	F_y [kN]	F_z [kN]	M_x [kNm]	M_y [kNm]	M_z [kNm]
ULS 1a_90		-42	1343	497	56512	-1692	0
ULS 1a_0,9_0		28	490	347	20377	1164	0
ULS 1a_0,9_0,9_90		-46	1302	208	54834	-1857	0
ULS 3_0		9	806	754	33814	380	0
SLS 7		0	422	394	17560	0	0

ULS-fundatiebelasting combinatie 1 en 3 wind haaks op de lijn of bissectrice en EDS, totaal geleiders en mast

Combinatie	F_x [kN]	F_y [kN]	F_z [kN]	M_x [kNm]	M_y [kNm]	M_z [kNm]
ULS 1a_90	-42	1716	1757	67205	-1692	0
ULS 1a_0,9_0,9_90	-46	1675	1153	65527	-1857	0
SLS 7	0	422	1444	17560	0	0

Fundatiebelastingen, selectie belastingcombinaties op basis grootste waarde

Combinatie	F_x [kN]	F_y [kN]	F_z [kN]	M_x [kNm]	M_y [kNm]	M_z [kNm]
ULS 1a_0,9_90	-42	1716	1246	67206	-1692	0
SPLS 3_80 Ah All Cts	-1881	508	1582	20107	-79016	9
SPLS 3_80 Ba Ct1	904	685	1690	28630	37591	-9731
SPLS 3_0,9_80 Ah All Cts	-1881	508	1158	20108	-79016	9

Noot: grootste waarden kunnen in meerdere combinaties voorkomen, een combinatie is weergegeven.

Oplegreacties op fundering per randstijl

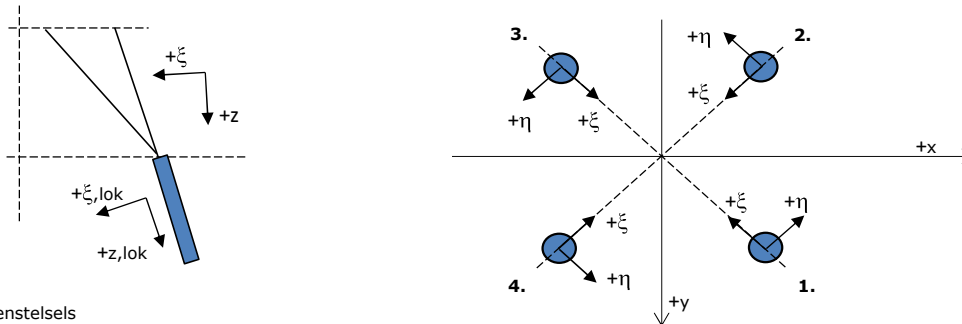

Assenstelsels

Maximale drukbelasting

Stijl	Combinatie	R_x [kN]	R_y [kN]	R_z [kN]	R_η [kN]	R_ξ [kN]	$R_{\xi,lok}$ [kN]	$R_{z,lok}$ [kN]
1	SPLS 3_100 Ba All Cts	709	842	4199	-94	-1097	31	4348
2	ULS 8 Ah	422	-605	2762	129	-726	17	2860
3	ULS 8 Ba	-422	-605	2762	-129	-726	17	2860
4	SPLS 3_80 Ah All Cts	-716	850	4237	95	-1107	32	4387

Maximale trekbelasting

Stijl	Combinatie	R_x [kN]	R_y [kN]	R_z [kN]	R_η [kN]	R_ξ [kN]	$R_{\xi,lok}$ [kN]	$R_{z,lok}$ [kN]
1	ULS 8 Ba	-263	-447	-2007	130	502	-37	-2078
2	SPLS 3_0,9_80 Ah All Cts	-573	706	-3552	-94	905	-50	-3678
3	SPLS 3_0,9_100 Ba All Cts	564	697	-3503	94	891	-50	-3627
4	SPLS 3_0,9_0 Ba All Cts	284	-456	-2060	-122	523	-30	-2133

Maximale torsiebelasting (positief)

Stijl	Combinatie	R_x [kN]	R_y [kN]	R_z [kN]	R_η [kN]	R_ξ [kN]	$R_{\xi,lok}$ [kN]	$R_{z,lok}$ [kN]
1	SPLS 3_90 Ah Ct1	271	-246	5	366	-18	-17	5
2	SPLS 3_0,9_90 Ba Ct2	-111	-393	759	357	-200	4	786
3	SPLS 3_90 Ba Ct2	173	586	-2116	292	536	-32	-2191
4	SPLS 3_0,9_90 Ah Ct1	-350	747	2970	280	-776	22	3075

Maximale torsiebelasting (negatief)

Stijl	Combinatie	R_x [kN]	R_y [kN]	R_z [kN]	R_η [kN]	R_ξ [kN]	$R_{\xi,lok}$ [kN]	$R_{z,lok}$ [kN]
1	SPLS 3_0,9_90 Ba Ct1	340	740	2921	-283	-764	20	3024
2	SPLS 3_90 Ah Ct2	-182	594	-2162	-291	548	-33	-2239
3	SPLS 3_0,9_90 Ah Ct2	103	-399	800	-355	-209	6	829
4	SPLS 3_90 Ba Ct1	-279	-240	43	-367	-28	-16	44

Project: RLL-TLB380
 Masttype: HA+3_c
 Mast: 1094

Combinatie Ftrek+Fhor

Stijl	Combinatie	R _x [kN]	R _y [kN]	R _z [kN]	R _η [kN]	R _ξ [kN]	R _{ξ,lok} [kN]	R _{z,lok} [kN]
1	SPLS 3_0,9_90 Ah All Cts	-249	-453	-1999	144	497	-40	-2070
2	SPLS 3_0,9_80 Ah All Cts	-573	706	-3552	-94	905	-50	-3678
3	SPLS 3_0,9_100 Ba All Cts	564	697	-3503	94	891	-50	-3627
4	SPLS 3_0,9_0 Ba All Cts	284	-456	-2060	-122	523	-30	-2133

Permanente belasting

Stijl	Combinatie	R _x [kN]	R _y [kN]	R _z [kN]	R _η [kN]	R _ξ [kN]	R _{ξ,lok} [kN]	R _{z,lok} [kN]
1	SLS 7	218	181	1041	26	-282	-2	1078
2	SLS 7	-67	30	-320	26	69	-17	-331
3	SLS 7	67	30	-320	-26	69	-17	-331
4	SLS 7	-218	181	1041	-26	-282	-2	1078

Omhullenden ongeacht stijl

Belasting	Combinatie	R _x [kN]	R _y [kN]	R _z [kN]	R _η [kN]	R _ξ [kN]	R _{ξ,lok} [kN]	R _{z,lok} [kN]
Max. druk	SPLS 3_80 Ah All Cts	-716	850	4237	95	-1107	32	4387
Max. trek	SPLS 3_0,9_80 Ah All Cts	-573	706	-3552	-94	905	-50	-3678
Max. pos. torsie	SPLS 3_90 Ah Ct1	271	-246	5	366	-18	-17	5
Max. neg. torsie	SPLS 3_90 Ba Ct1	-279	-240	43	-367	-28	-16	44
Comb. trek+torsie	SPLS 3_0,9_80 Ah All Cts	-573	706	-3552	-94	905	-50	-3678

Maximale trekbelasting SLS

Stijl	Combinatie	R _x [kN]	R _y [kN]	R _z [kN]	R _η [kN]	R _ξ [kN]	R _{ξ,lok} [kN]	R _{z,lok} [kN]
1	SPLS 3_0,9_80 Ah All Cts	-247	-453	-1994	146	495	-41	-2064
2	SPLS 3_0,9_80 Ah All Cts	-573	706	-3552	-94	905	-50	-3678
3	SPLS 1a_0,9_100 Ba Ct2	249	597	-2336	246	599	-29	-2419
4	SPLS 3_0,9_100 Ba Ct2	131	102	-161	165	21	-23	-167

Maximale drukbelasting SLS

Stijl	Combinatie	R _x [kN]	R _y [kN]	R _z [kN]	R _η [kN]	R _ξ [kN]	R _{ξ,lok} [kN]	R _{z,lok} [kN]
1	SPLS 1a_100 Ba Ct2	719	424	3037	209	-808	8	3145
2	SPLS 3_100 Ba Ct2	-77	-419	919	351	-242	5	951
3	SPLS 3_80 Ah All Cts	-390	-595	2679	-145	-697	23	2774
4	SPLS 3_80 Ah All Cts	-716	850	4237	95	-1107	32	4387

Project: RLL-TLB380
Masttype: HA+3_c
Mast: 1094

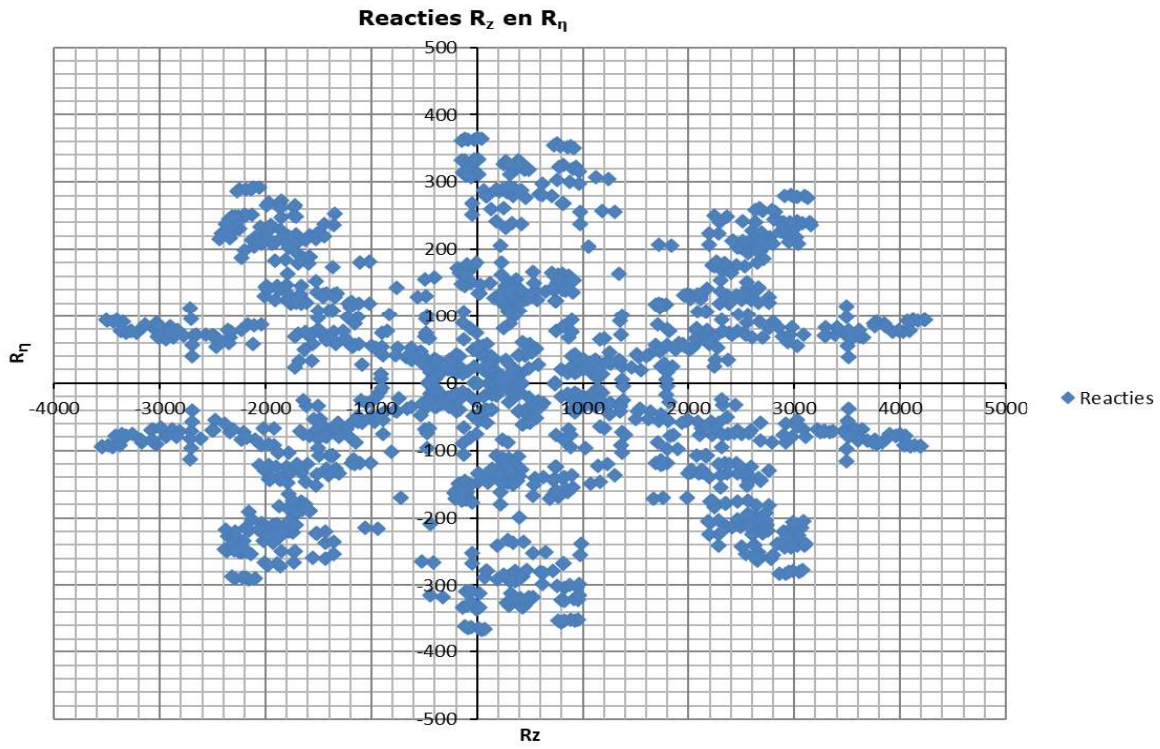

Project: RLL-TLB380
Tower: HA+6_c
Number: 1078

Auteur: TBR
Versie: v12.0

Geleiderbelastingen

Algemeen

Benaming HA+6_c
Masttype Hoekmast
Aantal circuits 4
Configuratie 4-circuit-dubbel verticaal
Aantal bliksemgeleiders 2

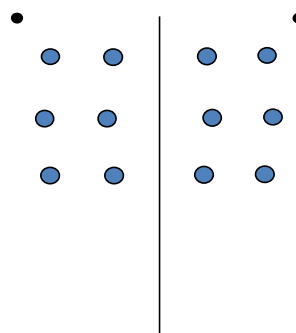

Configuratie geleiders

Uitgangspunten

Norm NEN-EN50341-2-15:2019
Gevolgklasse initieel CC2
Betrouwbaarheidsniveau initieel Nieuwbouw
Referentieperiode initieel 50 jaar
Betrouwbaarheidsniveau na aanpassing n.v.t.
50 jaar
Windgebied III
Windsnelheid (m/s) 24,5 m/s
Terreincategorie II
Reductiefactor C_{dir} 1,00
IJSgebied fasegeleider B
IJSgebied bliksemgeleider A

Geleiders Back

Omschrijving	Spanning	Geleider Back	Bundel Ba	IJSgebied	Toeslag gewicht	Toeslag diameter	Intrekwaarden P_{back}
Circuit 1	380 kV	AAAC-AL7 620	4	B	3 %	3 %	1800
Circuit 2	380 kV	AAAC-AL7 620	4	B	3 %	3 %	1800
Circuit 3	150 kV	AAAC-AL7 620	2	B	3 %	3 %	1800
Circuit 4	150 kV	AAAC-AL7 620	2	B	3 %	3 %	1800
Bliksemdraad 1		AACSR 241-AL3-39-A20SA	1	A	2 %	2 %	1800
Bliksemdraad 2		OPGW AFL-226/38	1	A	2 %	2 %	1800

Geleiders Ahead

Omschrijving	Spanning	Geleider Ahead	Bundel Ah	IJSgebied	Toeslag gewicht	Toeslag diameter	Intrekwaarden P_{ahead}
Circuit 1	380 kV	AAAC-AL7 620	4	B	3 %	3 %	1800
Circuit 2	380 kV	AAAC-AL7 620	4	B	3 %	3 %	1800
Circuit 3	150 kV	AAAC-AL7 620	2	B	3 %	3 %	1800
Circuit 4	150 kV	AAAC-AL7 620	2	B	3 %	3 %	1800
Bliksemdraad 1		AACSR 241-AL3-39-A20SA	1	A	2 %	2 %	1800
Bliksemdraad 2		OPGW AFL-226/38	1	A	2 %	2 %	1800

Isolatoren (1)

Omschrijving	Ophanging	Gewicht [kN]	Lengte [m]	Windopp. [m ²]
Circuit 1	Afspanketting	3,00	6,50	1,10
Circuit 2	Afspanketting	3,00	6,50	1,10
Circuit 3	Afspanketting	2,00	3,50	0,80
Circuit 4	Afspanketting	2,00	3,50	0,80
Bliksemdraad 1	Afspanketting	0,10	0,20	0,10
Bliksemdraad 2	Afspanketting	0,10	0,20	0,10

1. Eigenschappen gelden voor geheel van de isolatorset

Ophanghoogte en positie in mast

Circuits	Aanduiding	Nummer	Ophanghoogte	Aangrijppunt	Positie in mast Horizontale afstand
Circuit 1	10	380ct1f1	54,0 m	54,0 m	-10,8 m
Circuit 1	11	380ct1f2	44,0 m	44,0 m	-14,3 m
Circuit 1	12	380ct1f3	34,5 m	34,5 m	-11,4 m
Circuit 2	40	380ct2f1	54,0 m	54,0 m	10,8 m
Circuit 2	41	380ct2f2	44,0 m	44,0 m	14,3 m
Circuit 2	42	380ct2f3	34,5 m	34,5 m	11,4 m
Circuit 3	20	150ct3f1	54,0 m	54,0 m	-4,3 m
Circuit 3	21	150ct3f2	44,0 m	44,0 m	-7,8 m
Circuit 3	22	150ct3f3	34,5 m	34,5 m	-4,9 m
Circuit 4	30	150ct4f1	54,0 m	54,0 m	4,3 m
Circuit 4	31	150ct4f2	44,0 m	44,0 m	7,8 m
Circuit 4	32	150ct4f3	34,5 m	34,5 m	4,9 m
Bliksemdraad 1	1	bl1	59,1 m	59,1 m	-16,2 m
Bliksemdraad 2	3	bl2	59,1 m	59,1 m	16,2 m

Project: RLL-TLB380
 Tower: HA+6_c
 Number: 1078

Hoogteaanpassing naastgelegen masten (aanpassing wind- en weight span)

	Back	Ahead	
Verhoging voor windbelasting	12,0 m	6,0 m	(positief: omhoog)
Verlaging voor verticale belasting	-9,0 m	-6,0 m	(negatief: omlaag, grotere weight span)
Verlaging:	Niet in 0,9EG-combinaties		

Hoogteafwijking mastbeeld naastgelegen masten en richtingsverandering t.o.v. Lijnrichting

Circuits	Aanduiding	Nummer	Hoogteverschil		Richtingsverandering	
			Δh back	Δh ahead	Δy back	Δy ahead
Circuit 1	10	380ct1f1	0,0	0,0 m	0,0	0,0 m
Circuit 1	11	380ct1f2	0,0	0,0 m	0,0	0,0 m
Circuit 1	12	380ct1f3	0,0	0,0 m	0,0	0,0 m
Circuit 2	40	380ct2f1	0,0	0,0 m	0,0	0,0 m
Circuit 2	41	380ct2f2	0,0	0,0 m	0,0	0,0 m
Circuit 2	42	380ct2f3	0,0	0,0 m	0,0	0,0 m
Circuit 3	20	150ct3f1	0,0	0,0 m	0,0	0,0 m
Circuit 3	21	150ct3f2	0,0	0,0 m	0,0	0,0 m
Circuit 3	22	150ct3f3	0,0	0,0 m	0,0	0,0 m
Circuit 4	30	150ct4f1	0,0	0,0 m	0,0	0,0 m
Circuit 4	31	150ct4f2	0,0	0,0 m	0,0	0,0 m
Circuit 4	32	150ct4f3	0,0	0,0 m	0,0	0,0 m
Bliksemdraad 1	1	bl1	0,0	0,0 m	0,0	0,0 m
Bliksemdraad 2	3	bl2	0,0	0,0 m	0,0	0,0 m

Lijn- en mastgegevens

	Back	Ahead
Ruling span $\sqrt{(\Sigma L^3)/\Sigma L}$	400,0	400,0 m
Lijnhoek β	160 °	
Rotatie mast t.o.v. bissectrice θ	0 °	
Vaklengte	400	400 m
Hoogte onderkant mast t.o.v. maaiveld	0,5 m	
Beschouwde windrichtingen	α_1	0 °
Windrichtingen volgens:	α_2	45 °
Geleiderbelastingen	α_3	90 °
	α_4	135 °
	α_5	80 °
	α_6	100 °

Windrichtingen gelden t.o.v. hoofdrichting mastconstructie, niet t.o.v. bissectrice.

Windrichtingen en positieve richtingen belastingen

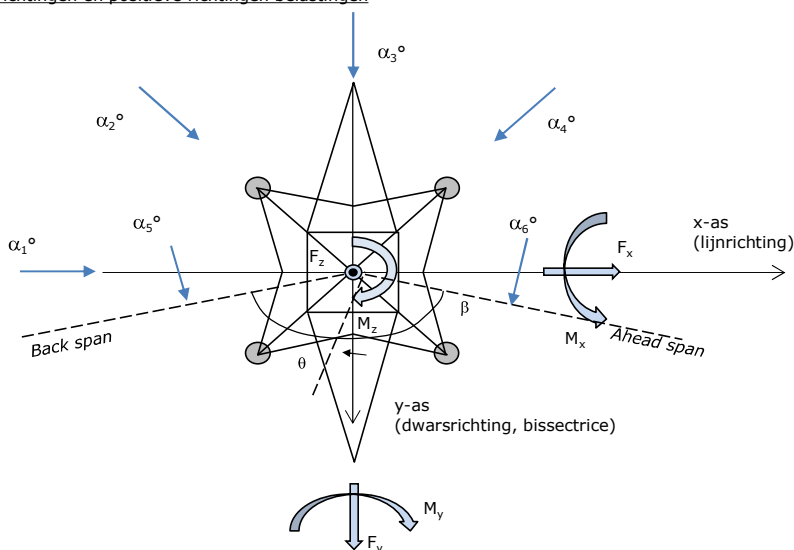

Beschouwd aantal windrichtingen

1a	6
3	6
4	1
6	1
Overig	1

Project: RLL-TLB380
 Tower: HA+6_c
 Number: 1078

Geleiderafval

		SPLS - torsie		SPLS - Enkelzijdige trek		5a - geleiderbreuk	
		Aanw.	Afw.	Aanw.	Afw.	Aanw.	Afw.
Circuit 1	380ct1f1	1	0	1	0	1	0
Circuit 1	380ct1f2	1	0	1	0	1	0
Circuit 1	380ct1f3	1	0	1	0	1	0
Circuit 2	380ct2f1	0	1	1	0	1	0
Circuit 2	380ct2f2	0	1	1	0	1	0
Circuit 2	380ct2f3	0	1	1	0	1	0
Circuit 3	150ct3f1	1	0	1	0	1	0
Circuit 3	150ct3f2	1	0	1	0	1	0
Circuit 3	150ct3f3	1	0	1	0	1	0
Circuit 4	150ct4f1	0	1	1	0	1	0
Circuit 4	150ct4f2	0	1	1	0	1	0
Circuit 4	150ct4f3	0	1	1	0	1	0
Bliksemdraad 1	b11	1	0	1	0	1	0
Bliksemdraad 2	b12	0	1	1	0	1	0

Belastingssituaties SPLS

Beschouwde situaties SPLS: 1 t/m 6, alle mogelijke situaties.

Principe belastingssituaties:

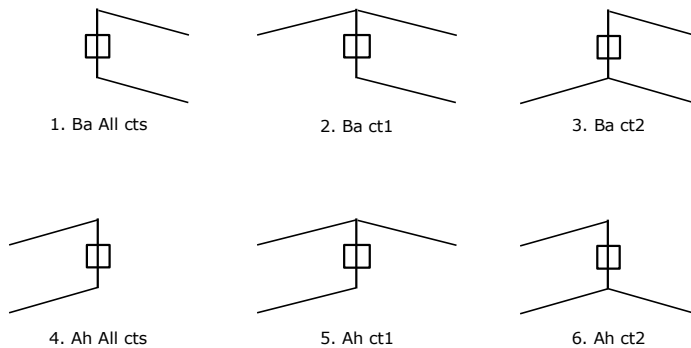

Belastingssituaties 5a. Geleiderbreuk

Beschouwde situaties geleiderbreuk 5a: 1 en 2, alle mogelijke situaties.

Principe belastingssituaties:

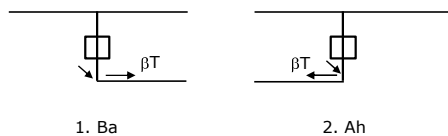

Project: RLL-TLB380
 Tower: HA+6_c
 Number: 1078

Belastingsituaties 6. Bouw- en onderhoud

Onder 6a wordt de belasting door aanwezigheid lijnwagen of lijnfiets in combinatie met puntlast op traverse in rekening gebracht. Combinatie 6b bevat geen belastingen in geleider of op traverse. Deze combinatie is toegevoegd om te kunnen combineren met separate controle bordessen etc. De situaties worden in ULS en in iedere SPLS-situatie (in geval van hoekmast) toegepast.

	Fase	Bliksem
Lijnwagen	4,0 kN	2,0 kN
Puntlast op traverse	1,0 kN	1,0 kN

Beschouwde situaties bouw- en onderhoud 6a: 1 t/m 4, alle mogelijke situaties.

Aanwezigheid lijnwagen: Circuit, belasting tegelijk aanwezig in alle geleiders per circuit.

Principe belastingssituaties:

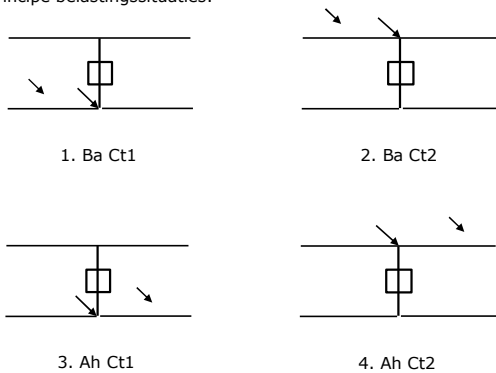

Belastingsituaties 8. Lijndansen als statische belasting

Geleider		
Steunmast fase	0,866 W	1,5 W
Steunmast bliksem	1,5 EDS	1,5 W
Hoekmast fase en bliksem	1,5 EDS	1,5 W

Beschouwde situaties lijndansen 8: 1 en 2, alle mogelijke situaties.

Belasting tegelijk aanwezig in alle geleiders van het circuit.

Principe belastingssituaties:

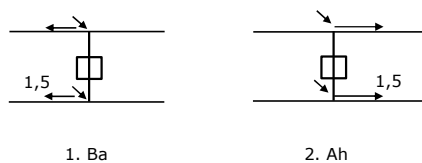

Belastingcombinatie 8. Lijndansen als dynamische belasting

Alleen van toepassing op hoek- en eindmasten

Belasting bestaat uit EDS-trekbelasting in één van de geleiders aan één zijde van de mast

Door gebruiker via het belastingspectrum van tabel 4.11/NL.1 om te zetten naar spanningspectrum

Project: RLL-TLB380
 Tower: HA+6_c
 Number: 1078

Mastconstructie

Eigenschappen

Masttype	Hoekmast	
Mastbenaming	HA+6_c	
Voetplaat t.o.v. maaiveld	0,5 m	
Masthoogte t.o.v. voetplaat	59,1 m	
Gewicht mast	1124,0 kN	
<i>Breedte en helling mast bij fundatie</i>	x-ri.	y-ri.
Pootsprei	14,04	14,04 m
Helling van de randstijl	0,190	0,190 -
Factor spatkracht	1,1	1,1 -

Berekening windbelasting

Dynamische invloed G_T	1,00 (<i>Masthoogte < 60 m</i>)
Windbelasting overhoeks op mastlichaam evenredig met:	$(A1C1\sin^2(\phi)+A2C2\cos^2(\phi))$
Windbelasting overhoeks op traverse evenredig met:	$(A1C1\sin^2(\phi)+A2C2\cos^2(\phi))$
Vergroting wind overhoeks mastlichaam	$(1+0,2\sin^2(2\phi))$
Vergroting wind overhoeks traverse	$(1+0,2\sin^2(2\phi))$
Factor wind evenwijdig t.o.v. haaks op traverse	0,4

Eigenschappen mastsecties langsrichting (vooraanzicht, yz-vlak)

Omschrijving	h [m]	b ₁ [m]	b ₂ [m]	Δh [m]	Δ _x [m]	A ₀ [m ²]	A ₁ [m ²]	χ = A ₁ /A ₀ [-]	C _t
Broekstuk	21,40	14,04	5,91	21,40	0,190	213,49	48,90	0,23	2,81
Eerste tussenstuk	28,20	5,91	5,23	6,80	0,050	37,88	13,24	0,35	2,37
Tweede tussenstuk	34,50	5,23	4,60	6,30	0,050	30,96	10,25	0,33	2,43
Bovenstuk 1	44,00	4,60	3,65	9,50	0,050	39,19	11,88	0,30	2,52
Bovenstuk 2	57,40	3,65	2,31	13,40	0,050	39,93	13,01	0,33	2,45
Topstuk	59,10	2,31		1,70		1,96	0,33	0,17	3,08
Ondertraverse	34,50	9,40		3,10		14,57	4,37	0,30	2,54
Middentraverse	44,00	12,78		3,20		20,45	6,34	0,31	2,50
Boventraverse	54,00	14,88		5,10		37,93	7,34	0,19	2,96

Eigenschappen mastsecties dwarsrichting (zijaanzicht, xz-vlak)

Omschrijving	h [m]	b ₁ [m]	b ₂ [m]	Δh [m]	Δ _x [m]	A ₀ [m ²]	A ₁ [m ²]	χ = A ₁ /A ₀ [-]	C _t
Broekstuk	21,40	14,04	5,91	21,40	0,190	213,49	48,90	0,23	2,81
Eerste tussenstuk	28,20	5,91	5,23	6,80	0,050	37,88	13,24	0,35	2,37
Tweede tussenstuk	34,50	5,23	4,60	6,30	0,050	30,96	10,25	0,33	2,43
Bovenstuk 1	44,00	4,60	3,65	9,50	0,050	39,19	11,88	0,30	2,52
Bovenstuk 2	57,40	3,65	2,31	13,40	0,050	39,93	13,01	0,33	2,45
Topstuk	59,10	2,31		1,70		1,96	0,33	0,17	3,08
Ondertraverse	34,50	9,40		3,10		14,57	4,37	0,30	2,54
Middentraverse	44,00	12,78		3,20		20,45	6,34	0,31	2,50
Boventraverse	54,00	14,88		5,10		37,93	7,34	0,19	2,96

NB: oppervlakte traverse dwarsrichting van de tabel wordt in berekening gereduceerd.
 NB: oppervlakte traverse per zijde, dus helft van totaal van twee traveres.

Project: RLL-TLB380
 Tower: HA+6_c
 Number: 1078

Windoppervlak feeders telecominstallaties

Onderdeel	A (m ² /m)	Factor	Δh	A ₁
Broekstuk	0,14	0,71	21,4	2,1
Eerste tussenstuk	0,14	0,71	6,8	0,7
Tweede tussenstuk	0,14	0,71	6,3	0,6
Bovenstuk 1	0,14	0,71	9,5	0,9
Bovenstuk 2				

Invoer antennes

Omschrijving	A (m ²)	h (m)	C _i (m)
Antenne top			
Antenne o.t.	4,7	40,7	1,5

Belastingen mastsectie langsrichting (x-richting) per windrichting

Omschrijving	P _w [kN/m ²]	F _{x1} [kN]	F _{x2} [kN]	F _{x3} [kN]	F _{x4} [kN]	h _{ef} [m]	M _{y1} [kNm]	M _{y2} [kNm]	M _{y3} [kNm]	M _{y4} [kNm]
Broekstuk	0,72	98,5	83,6	0,0	-83,6	10,7	1054,1	894,4	0,0	-894,4
Eerste tussenstuk	0,94	29,3	24,9	0,0	-24,9	24,8	727,4	617,3	0,0	-617,3
Tweede tussenstuk	1,00	24,9	21,1	0,0	-21,1	31,4	780,8	662,5	0,0	-662,5
Bovenstuk 1	1,07	32,0	27,2	0,0	-27,2	39,3	1257,3	1066,9	0,0	-1066,9
Bovenstuk 2	1,14	36,3	30,8	0,0	-30,8	50,7	1837,9	1559,5	0,0	-1559,5
Topstuk	1,18	1,2	1,0	0,0	-1,0	58,3	69,6	59,1	0,0	-59,1
Ondertraverse	1,04	22,9	13,6	0,0	-13,6	35,5	815,3	484,2	0,0	-484,2
Middentraverse	1,10	35,0	20,8	0,0	-20,8	45,1	1578,4	937,5	0,0	-937,5
Boventraverse	1,17	50,7	30,1	0,0	-30,1	55,7	2825,4	1678,2	0,0	-1678,2
Totaal		330,9	253,1	0,0	-253,1		10946,2	7959,6	0,0	-7959,6

Belastingen mastsectie dwarsrichting (y-richting) per windrichting

Omschrijving	P _w [kN/m ²]	F _{y1} [kN]	F _{y2} [kN]	F _{y3} [kN]	F _{y4} [kN]	h _{ef} [m]	M _{x1} [kNm]	M _{x2} [kNm]	M _{x3} [kNm]	M _{x4} [kNm]
Broekstuk	0,72	0,0	83,6	98,5	83,6	10,7	0,0	894,4	1054,1	894,4
Eerste tussenstuk	0,94	0,0	24,9	29,3	24,9	24,8	0,0	617,3	727,4	617,3
Tweede tussenstuk	1,00	0,0	21,1	24,9	21,1	31,4	0,0	662,5	780,8	662,5
Bovenstuk 1	1,07	0,0	27,2	32,0	27,2	39,3	0,0	1066,9	1257,3	1066,9
Bovenstuk 2	1,14	0,0	30,8	36,3	30,8	50,7	0,0	1559,5	1837,9	1559,5
Topstuk	1,18	0,0	1,0	1,2	1,0	58,3	0,0	59,1	69,6	59,1
Ondertraverse	1,04	0,0	13,6	9,2	13,6	35,5	0,0	484,2	326,1	484,2
Middentraverse	1,10	0,0	20,8	14,0	20,8	45,1	0,0	937,5	631,3	937,5
Boventraverse	1,17	0,0	30,1	20,3	30,1	55,7	0,0	1678,2	1130,2	1678,2
Totaal		0,0	253,1	265,7	253,1		0,0	7959,6	7814,8	7959,6

Resulterende belastingen vanuit mastconstructie incl. antenne zonder geleiders niveau fundatie (kar. waarde)

Belasting / windrichting	F _x [kN]	F _y [kN]	F _z [kN]	M _x [kNm]	M _y [kNm]	M _z [kNm]
Permanente belasting	0	0	1124	0	0	0
Windrichting 0°	339	0	0	0	11255	0
Windrichting 45°	258	258	0	8178	8178	0
Windrichting 90°	0	273	0	8123	0	0
Windrichting 135°	-258	258	0	8178	-8178	0

Project: RLL-TLB380
 Tower: HA+6_c
 Number: 1078

Tussenresultaten geleiderbelastingen

Geleiders back

Circuit	Geleider	Diameter [mm]	A [mm ²]	G [N/m]	E [N/mm ²]	αT [-]
Circuit 1	AAAC-AL7 620	32,4	621,0	17,71	56000	2,30E-05
Circuit 2	AAAC-AL7 620	32,4	621,0	17,71	56000	2,30E-05
Circuit 3	AAAC-AL7 620	32,4	621,0	17,71	56000	2,30E-05
Circuit 4	AAAC-AL7 620	32,4	621,0	17,71	56000	2,30E-05
Bliksemdraad 1	AACSR 241-AL3-39-A20SA	21,8	281,0	9,38	70165	1,97E-05
Bliksemdraad 2	OPGW AFL-226/38	21,7	264,0	9,13	72000	1,98E-05

Geleiders ahead

Circuit	Geleider	Diameter [mm]	A [mm ²]	G [N/m]	E [N/mm ²]	αT [-]
Circuit 1	AAAC-AL7 620	32,4	621,0	17,71	56000	2,30E-05
Circuit 2	AAAC-AL7 620	32,4	621,0	17,71	56000	2,30E-05
Circuit 3	AAAC-AL7 620	32,4	621,0	17,71	56000	2,30E-05
Circuit 4	AAAC-AL7 620	32,4	621,0	17,71	56000	2,30E-05
Bliksemdraad 1	AACSR 241-AL3-39-A20SA	21,8	281,0	9,38	70165	1,97E-05
Bliksemdraad 2	OPGW AFL-226/38	21,7	264,0	9,13	72000	1,98E-05

Verticale belasting back

Circuit	Bundel [-]	Toeslag [%]	$W_{z,G}$ [N/m]	IJsgebied	Formule	$W_{z,ijs}$ [N/m]	$W_{z,ijs,bundel}$ [N/m]
Circuit 1	4	3	73,0	B	4+0,2d	10,5	41,9
Circuit 2	4	3	73,0	B	4+0,2d	10,5	41,9
Circuit 3	2	3	36,5	B	4+0,2d	10,5	21,0
Circuit 4	2	3	36,5	B	4+0,2d	10,5	21,0
Bliksemdraad 1	1	2	9,6	A	15+0,4d	23,7	23,7
Bliksemdraad 2	1	2	9,3	A	15+0,4d	23,7	23,7

Verticale belasting ahead

Circuit	Bundel [-]	Toeslag [%]	$W_{z,G}$ [N/m]	IJsgebied	Formule	$W_{z,ijs}$ [N/m]	$W_{z,ijs,bundel}$ [N/m]
Circuit 1	4	3	73,0	B	4+0,2d	10,5	41,9
Circuit 2	4	3	73,0	B	4+0,2d	10,5	41,9
Circuit 3	2	3	36,5	B	4+0,2d	10,5	21,0
Circuit 4	2	3	36,5	B	4+0,2d	10,5	21,0
Bliksemdraad 1	1	2	9,6	A	15+0,4d	23,7	23,7
Bliksemdraad 2	1	2	9,3	A	15+0,4d	23,7	23,7

Isolatoren

Geleider	$G_{isolator}$ [kN]	Aantal	$F_{v,iso}$ [kN]	Lengte [m]	Windopp. [m ²]	Windhoogte [m]	Stuwdruk [kN/m ²]	Vormfactor [-]	$F_{h,iso}$ [kN]
380ct1f1	3,00	1	3	6,5	1,1	54,50	1,16	1,2	1,53
380ct1f2	3,00	1	3	6,5	1,1	44,50	1,10	1,2	1,45
380ct1f3	3,00	1	3	6,5	1,1	35,00	1,03	1,2	1,36
380ct2f1	3,00	1	3	6,5	1,1	54,50	1,16	1,2	1,53
380ct2f2	3,00	1	3	6,5	1,1	44,50	1,10	1,2	1,45
380ct2f3	3,00	1	3	6,5	1,1	35,00	1,03	1,2	1,36
150ct3f1	2,00	1	2	3,5	0,8	54,50	1,16	1,2	1,11
150ct3f2	2,00	1	2	3,5	0,8	44,50	1,10	1,2	1,06
150ct3f3	2,00	1	2	3,5	0,8	35,00	1,03	1,2	0,99
150ct4f1	2,00	1	2	3,5	0,8	54,50	1,16	1,2	1,11
150ct4f2	2,00	1	2	3,5	0,8	44,50	1,10	1,2	1,06
150ct4f3	2,00	1	2	3,5	0,8	35,00	1,03	1,2	0,99
bl1	0,10	1	0,1	0,2	0,1	59,60	1,19	1,2	0,14
bl2	0,10	1	0,1	0,2	0,1	59,60	1,19	1,2	0,14

Project: RLL-TLB380
 Tower: HA+6_c
 Number: 1078

Windbelasting back

Geleider	hoogte		G _{c,dwars} [-]	G _{c,trek} [-]	C _c [-]	d _{toeslag} [mm]	W _y [N/m]	W _{y,vak} [N/m]	D _{jjs,toeslag} [mm]	W _{y,ijs} [N/m]	W _{y,ijs,vak} [N/m]
	wind [m]	Stuwdruk [kN/m ²]									
380ct1f1	53,1	1,15	0,62	0,68	0,95	33,37	91,4	100,4	51,8	178,5	196,2
380ct1f2	43,1	1,09	0,61	0,67	0,97	33,37	85,9	94,5	51,8	164,5	181,0
380ct1f3	33,6	1,02	0,59	0,65	1,00	33,37	79,5	87,5	51,8	148,8	163,8
380ct2f1	53,1	1,15	0,62	0,68	0,95	33,37	91,4	100,4	51,8	178,5	196,2
380ct2f2	43,1	1,09	0,61	0,67	0,97	33,37	85,9	94,5	51,8	164,5	181,0
380ct2f3	33,6	1,02	0,59	0,65	1,00	33,37	79,5	87,5	51,8	148,8	163,8
150ct3f1	53,1	1,15	0,62	0,68	0,95	33,37	45,7	50,2	51,8	89,2	98,1
150ct3f2	43,1	1,09	0,61	0,67	0,97	33,37	42,9	47,2	51,8	82,3	90,5
150ct3f3	33,6	1,02	0,59	0,65	1,00	33,37	39,7	43,7	51,8	74,4	81,9
150ct4f1	53,1	1,15	0,62	0,68	0,95	33,37	45,7	50,2	51,8	89,2	98,1
150ct4f2	43,1	1,09	0,61	0,67	0,97	33,37	42,9	47,2	51,8	82,3	90,5
150ct4f3	33,6	1,02	0,59	0,65	1,00	33,37	39,7	43,7	51,8	74,4	81,9
bl1	58,2	1,18	0,63	0,69	1,18	22,24	19,4	21,3	63,1	56,3	61,8
bl2	58,2	1,18	0,63	0,69	1,18	22,13	19,4	21,3	63,0	56,2	61,8

Windbelasting ahead

Geleider	hoogte		G _{c,dwars} [-]	G _{c,trek} [-]	C _c [-]	d _{toeslag} [mm]	W _y [N/m]	W _{y,vak} [N/m]	D _{jjs,toeslag} [mm]	W _{y,ijs} [N/m]	W _{y,ijs,vak} [N/m]
	wind [m]	Stuwdruk [kN/m ²]									
380ct1f1	50,1	1,14	0,62	0,68	0,96	33,37	89,8	98,8	51,8	174,5	191,9
380ct1f2	40,1	1,07	0,60	0,66	0,98	33,37	84,0	92,4	51,8	159,9	175,9
380ct1f3	30,6	0,99	0,58	0,64	1,00	33,37	77,1	84,9	51,8	143,2	157,6
380ct2f1	50,1	1,14	0,62	0,68	0,96	33,37	89,8	98,8	51,8	174,5	191,9
380ct2f2	40,1	1,07	0,60	0,66	0,98	33,37	84,0	92,4	51,8	159,9	175,9
380ct2f3	30,6	0,99	0,58	0,64	1,00	33,37	77,1	84,9	51,8	143,2	157,6
150ct3f1	50,1	1,14	0,62	0,68	0,96	33,37	44,9	49,4	51,8	87,3	95,9
150ct3f2	40,1	1,07	0,60	0,66	0,98	33,37	42,0	46,2	51,8	79,9	88,0
150ct3f3	30,6	0,99	0,58	0,64	1,00	33,37	38,6	42,4	51,8	71,6	78,8
150ct4f1	50,1	1,14	0,62	0,68	0,96	33,37	44,9	49,4	51,8	87,3	95,9
150ct4f2	40,1	1,07	0,60	0,66	0,98	33,37	42,0	46,2	51,8	79,9	88,0
150ct4f3	30,6	0,99	0,58	0,64	1,00	33,37	38,6	42,4	51,8	71,6	78,8
bl1	55,2	1,17	0,62	0,69	1,18	22,24	19,1	21,0	63,1	55,2	60,6
bl2	55,2	1,17	0,62	0,69	1,18	22,13	19,0	20,9	63,0	55,1	60,5

NB: belastingen w_v gelden voor bundel

Project: RLL-TLB380
 Masttype: HA+6_c
 Mast: 1078

Auteur: TBR
 Versie: v12.0

Geleiderbelastingen

Uitgangspunten

Betrouwbaarheidsniveau Nieuwbouw CC2
 Referentieperiode 50 jaar

ULS (bezwijksterkte)		NEN-EN50341-2-15:2019							
Belastingsgeval	omschrijving	Temp °C	γ_G		γ_Q			γ_a A_k	
			$G_{k,mast}$	$G_{k,geleider}$	Q_{pk}	Q_{wk}	Q_{ik}		
ULS 1a	Wind	10°	1,20	1,20	0,00	1,50	0,00	0,0	
ULS 1a_0,9	Wind 0,9Gk alleen mast	10°	0,90	1,20	0,00	1,50	0,00	0,0	
ULS 1a_0,9_0,9	Wind 0,9Gk ook geleider	10°	0,90	0,90	0,00	1,50	0,00	0,0	
ULS 3	Wind+ijs	-5°	1,20	1,20	0,00	0,45	1,50	0,0	
ULS 3_0,9	Wind+ijs 0,9	-5°	0,90	1,20	0,00	0,45	1,50	0,0	
ULS 4	Koude+wind	-20°	1,20	1,20	0,00	0,30	0,00	0,0	
ULS 4_0,9	Koude+wind 0,9	-20°	0,90	1,20	0,00	0,30	0,00	0,0	
ULS 5a	Torsiebelastingen	10°	1,00	1,00	1,00	0,00	0,00	1,0	
ULS 5b	Longitudinale belastingen	10°	1,00	1,00	0,00	0,00	0,00	1,0	
ULS 6	Bouw en onderhoud	5°	1,20	1,20	1,50	0,30	0,00	0,0	
ULS 6_0,9	Bouw en onderhoud	5°	1,20	1,20	0,00	0,30	0,00	0,0	
ULS 7	Permanent	10°	1,35	1,35	0,00	0,00	0,00	0,0	
ULS 8	Special	10°	1,00	1,00	0,00	0,00	0,00	1,0	
SPLS (Bezwijksterkte, enkel voor hoekmasten: afwezigheid geleiders)			γ_G		γ_Q				
			G_k	G_k	Q_{pk}	Q_{wk}	Q_{ik}	A_k	
SPLS 1a	Wind	10°	1,20	1,20	0,0	0,78	0,00	0,0	
SPLS 1a_0,9	Wind 0,9	10°	0,90	1,20	0,0	0,78	0,00	0,0	
SPLS 1a_0,9_0,9	Wind 0,9	10°	0,90	0,90	0,0	0,78	0,00	0,0	
SPLS 3	Wind+ijs	-5°	1,20	1,20	0,0	0,36	0,34	0,0	
SPLS 3_0,9	Wind+ijs 0,9	-5°	0,90	1,20	0,0	0,36	0,34	0,0	
SPLS 4	Koude+wind	-20°	1,20	1,20	0,0	0,24	0,00	0,0	
SPLS 4_0,9	Koude+wind 0,9	-20°	0,90	1,20	0,0	0,24	0,00	0,0	
SPLS 6	Bouw en onderhoud	5°	1,20	1,20	1,2	0,24	0,0	0,0	
SPLS 6_0,9	Bouw en onderhoud	5°	1,20	1,20	0,0	0,24	0,0	0,0	
SLS (controle van de vervormingen, vermoeiing, EDS)			G_k		Q_{pk}	Q_{wk}	Q_{ik}	A_k	
			G_k	G_k	Q_{pk}	Q_{wk}	Q_{ik}	A_k	
SLS 1a	Wind	10°	1,00	1,00	0,0	1,00	0,0	0,0	
SLS 3	Wind+ijs	-5°	1,00	1,00	0,0	0,30	1,00	0,0	
SLS 4	Wind	-20°	1,00	1,00	0,0	0,20	0,0	0,0	
SLS 6	Bouw en onderhoud	5°	1,00	1,00	0,0	0,20	0,0	0,0	
SLS 7	PB (EDS, geen wind)	10°	1,00	1,00	0,0	0,00	0,0	0,0	

Aantal windrichtingen 6
 Aantal belastingcombinaties ULS 100
 Aantal belastingcombinaties SPLS 246
 Aantal belastingcombinaties SLS 15
 Aantal knooplasten 12274

Project: RLL-TLB380
 Masttype: HA+6_c
 Mast: 1078

Samenvattingstabellen geleiderbelastingen

In de onderstaande vier tabellen is weergegeven:

- De maximale geleiderbelasting in het globale assenstelsel, gesplitst in aandeel van back en ahead span
- De gecombineerde geleiderbelasting (Ba+Ah) in het globale assenstelsel met in het lokale assenstelsel de maximaal optredende trekkracht. Componenten Fx en Fy als absolute waarde
- De alledaagse (EDS) waarden van de gecombineerde geleiderbelastingen (Ba+Ah) met bijbehorende trekkrachten
- Controle op uplift, waar een negatieve waarde duidt op uplift

Maximale waarden voor back en ahead span

Geleider	Fx_ba [kN]	Fx_ah [kN]	Fy_ba [kN]	Fy_ah [kN]	Fz_ba [kN]	Fz_ah [kN]
bl1	-65,9	65,7	16,8	16,7	11,1	10,5
380ct1f1	-265,6	264,6	74,5	73,6	39,8	37,8
380ct1f2	-262,0	260,8	71,3	70,3	39,7	37,7
380ct1f3	-258,2	256,9	67,7	66,3	39,6	37,6
Post-isolato	0,0	0,0	0,0	0,0	0,0	
Post-isolato	0,0	0,0	0,0	0,0	0,0	
Post-isolato	0,0	0,0	0,0	0,0	0,0	
380ct2f1	-265,6	264,6	74,5	73,6	39,8	37,8
380ct2f2	-262,0	260,8	71,3	70,3	39,7	37,7
380ct2f3	-258,2	256,9	67,7	66,3	39,6	37,6
150ct3f1	-132,8	132,3	37,7	37,3	21,3	20,4
150ct3f2	-131,0	130,4	36,2	35,6	21,3	20,4
150ct3f3	-129,1	128,4	34,3	33,7	21,3	20,4
150ct4f1	-132,8	132,3	37,7	37,3	21,3	20,4
150ct4f2	-131,0	130,4	36,2	35,6	21,3	20,4
150ct4f3	-129,1	128,4	34,3	33,7	21,3	20,4
bl2	-65,0	64,8	16,7	16,5	11,0	10,5
Post-isolato	0,0	0,0	0,0	0,0	0,0	
Post-isolato	0,0	0,0	0,0	0,0	0,0	
Post-isolato	0,0	0,0	0,0	0,0	0,0	

Min. Weight span (m)

Weight spar Combinatie1

Geleider	SLS 1a	SLS 4	SLS 7
bl1	467,6	482,0	467,5
380ct1f1	467,5	480,5	467,5
380ct1f2	467,5	480,3	467,5
380ct1f3	467,5	480,0	467,5
Post-isolator 1			
Post-isolator 2			
Post-isolator 3			
380ct2f1	467,5	480,5	467,5
380ct2f2	467,5	480,3	467,5
380ct2f3	467,5	480,0	467,5
150ct3f1	467,5	480,5	467,5
150ct3f2	467,5	480,3	467,5
150ct3f3	467,5	480,0	467,5
150ct4f1	467,5	480,5	467,5
150ct4f2	467,5	480,3	467,5
150ct4f3	467,5	480,0	467,5
bl2	467,6	482,2	467,5
Post-isolator 4			
Post-isolator 5			
Post-isolator 6			

Max. Weight span (m)

Weight spar Combinatie1

Geleider	ULS 1a	ULS 3
bl1	548,6	453,7
380ct1f1	509,2	467,5
380ct1f2	505,5	466,5
380ct1f3	501,1	465,6
Post-isolator 1		
Post-isolator 2		
Post-isolator 3		
380ct2f1	509,2	467,5
380ct2f2	505,5	466,5
380ct2f3	501,1	465,6
150ct3f1	509,2	467,5
150ct3f2	505,5	466,5
150ct3f3	501,1	465,6
150ct4f1	509,2	467,5
150ct4f2	505,5	466,5
150ct4f3	501,1	465,6
bl2	550,8	453,4
Post-isolator 4		
Post-isolator 5		
Post-isolator 6		

Omhullende weight span over alle combinaties (incl. 0,9 combinaties)

Voor alle geleiders

Max. weight span	548,6 m
Min. weight span	166,8 m

Wind / Weight span verhouding

1,372 -
0,417 -

Project: RLL-TLB380
 Masttype: HA+6_c
 Mast: 1078

Maximale waarden back+ahead span Maximale waarden trekkracht geleider

Geleider	Fx [kN]	Fy [kN]	Fz [kN]	Ft_ba [kN]	Ft_ah [kN]
bl1	39,2	33,1	11,1	-67,8	67,6
380ct1f1	206,9	144,8	39,8	-272,7	271,5
380ct1f2	203,1	138,5	39,7	-268,8	267,5
380ct1f3	199,0	131,1	39,6	-264,7	263,3
Post-isolato	4,4	4,4	6,8	0,0	
Post-isolato	3,4	3,4	4,7	0,0	
Post-isolato	5,0	5,0	6,8	0,0	
380ct2f1	206,9	144,8	39,8	-272,7	271,5
380ct2f2	203,1	138,5	39,7	-268,8	267,5
380ct2f3	199,0	131,1	39,6	-264,7	263,3
150ct3f1	108,3	73,4	21,3	-136,3	135,8
150ct3f2	108,2	70,2	21,3	-134,4	133,8
150ct3f3	108,1	66,5	21,3	-132,3	131,6
150ct4f1	108,3	73,4	21,3	-136,3	135,8
150ct4f2	108,2	70,2	21,3	-134,4	133,8
150ct4f3	108,1	66,5	21,3	-132,3	131,6
bl2	38,6	32,8	11,0	-66,9	66,7
Post-isolato	4,4	4,4	6,8	0,0	
Post-isolato	3,4	3,4	4,7	0,0	
Post-isolato	5,0	5,0	6,8	0,0	

EDS-belastingen geleiders

Geleider	Fx [kN]	Fy [kN]	Fz [kN]	Ft_ba [kN]	Ft_ah [kN]
bl1	17,0	3,0	2,4	-17,2	17,2
380ct1f1	129,3	22,8	20,5	-131,3	131,3
380ct1f2	129,3	22,8	20,5	-131,3	131,3
380ct1f3	129,3	22,8	20,5	-131,3	131,3
Post-isolato	0,0	0,0	5,0	0,0	
Post-isolato	0,0	0,0	3,5	0,0	
Post-isolato	0,0	0,0	5,0	0,0	
380ct2f1	129,3	22,8	20,5	-131,3	131,3
380ct2f2	129,3	22,8	20,5	-131,3	131,3
380ct2f3	129,3	22,8	20,5	-131,3	131,3
150ct3f1	64,7	11,4	10,8	-65,7	65,7
150ct3f2	64,7	11,4	10,8	-65,7	65,7
150ct3f3	64,7	11,4	10,8	-65,7	65,7
150ct4f1	64,7	11,4	10,8	-65,7	65,7
150ct4f2	64,7	11,4	10,8	-65,7	65,7
150ct4f3	64,7	11,4	10,8	-65,7	65,7
bl2	16,5	2,9	2,3	-16,8	16,8
Post-isolato	0,0	0,0	5,0	0,0	
Post-isolato	0,0	0,0	3,5	0,0	
Post-isolato	0,0	0,0	5,0	0,0	

Controle uplift SLS-wind

Combinatie: Geleider	Fz_ba [kN]	Fz_ah [kN]
SLS 4 bl1	0,0	0,0
380ct1f1	0,0	0,0
380ct1f2	0,0	0,0
380ct1f3	0,0	0,0
Post-isolato	0,0	
Post-isolato	0,0	
Post-isolato	0,0	
380ct2f1	0,0	0,0
380ct2f2	0,0	0,0
380ct2f3	0,0	0,0
150ct3f1	0,0	0,0
150ct3f2	0,0	0,0
150ct3f3	0,0	0,0
150ct4f1	0,0	0,0
150ct4f2	0,0	0,0
150ct4f3	0,0	0,0
bl2	0,0	0,0
Post-isolato	0,0	
Post-isolato	0,0	
Post-isolato	0,0	

Project: RLL-TLB380
 Masttype: HA+6_c
 Mast: 1078

ULS-fundatiebelasting combinatie 1 en 3 wind haaks op de lijn of bissectrice en EDS, vanuit geleiders

Combinatie	Combination	F_x [kN]	F_y [kN]	F_z [kN]	M_x [kNm]	M_y [kNm]	M_z [kNm]
ULS 1a_90		-27	1329	515	59913	-1151	0
ULS 1a_0,9_0		28	490	358	21843	1265	0
ULS 1a_0,9_0,9_90		-29	1289	223	58143	-1260	0
ULS 3_0		9	806	771	36230	413	0
SLS 7		0	422	403	18826	0	0

ULS-fundatiebelasting combinatie 1 en 3 wind haaks op de lijn of bissectrice en EDS, totaal geleiders en mast

Combinatie	F_x [kN]	F_y [kN]	F_z [kN]	M_x [kNm]	M_y [kNm]	M_z [kNm]
ULS 1a_90	-27	1739	1864	72098	-1151	0
ULS 1a_0,9_0,9_90	-29	1699	1235	70328	-1260	0
SLS 7	0	422	1527	18826	0	0

Fundatiebelastingen, selectie belastingcombinaties op basis grootste waarde

Combinatie	F_x [kN]	F_y [kN]	F_z [kN]	M_x [kNm]	M_y [kNm]	M_z [kNm]
ULS 1a_0,9_90	-27	1739	1329	72099	-1151	0
SPLS 3_80 Ah All Cts	-1886	512	1686	21492	-84933	9
SPLS 3_80 Ba Ct1	913	691	1787	30717	40649	-9765
SPLS 3_0,9_80 Ah All Cts	-1886	512	1239	21493	-84933	9

Noot: grootste waarden kunnen in meerdere combinaties voorkomen, een combinatie is weergegeven.

Oplegreacties op fundering per randstijl

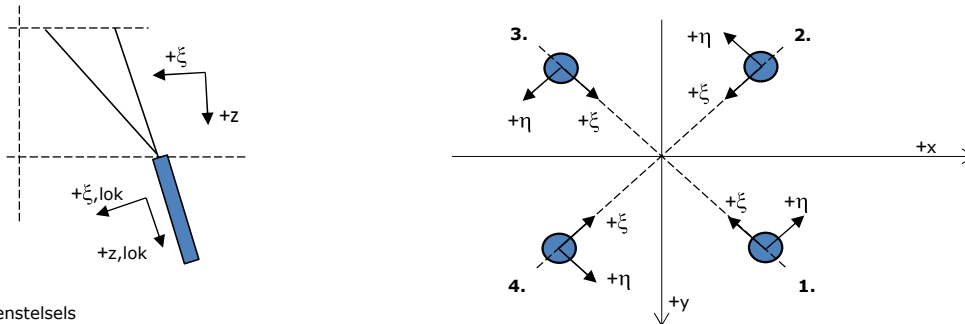

Assenstelsels

Maximale drukbelasting

Stijl	Combinatie	R_x [kN]	R_y [kN]	R_z [kN]	R_η [kN]	R_ξ [kN]	$R_{\xi,lok}$ [kN]	$R_{z,lok}$ [kN]
1	SPLS 3_100 Ba All Cts	714	843	4183	-91	-1101	23	4332
2	SPLS 3_0 Ba All Cts	438	-598	2750	113	-733	6	2847
3	ULS 8 Ba	-428	-600	2748	-122	-727	12	2846
4	SPLS 3_80 Ah All Cts	-719	848	4211	91	-1108	23	4360

Maximale trekbelasting

Stijl	Combinatie	R_x [kN]	R_y [kN]	R_z [kN]	R_η [kN]	R_ξ [kN]	$R_{\xi,lok}$ [kN]	$R_{z,lok}$ [kN]
1	SPLS 3_0,9_90 Ah All Cts	-250	-441	-1956	135	488	-37	-2026
2	SPLS 3_0,9_80 Ah All Cts	-567	695	-3480	-91	892	-43	-3603
3	SPLS 3_0,9_100 Ba All Cts	561	689	-3448	90	884	-43	-3571
4	SPLS 3_0,9_0 Ba All Cts	284	-445	-2015	-114	516	-26	-2087

Maximale torsiebelasting (positief)

Stijl	Combinatie	R_x [kN]	R_y [kN]	R_z [kN]	R_η [kN]	R_ξ [kN]	$R_{\xi,lok}$ [kN]	$R_{z,lok}$ [kN]
1	SPLS 3_90 Ah Ct1	259	-221	35	339	-27	-18	36
2	SPLS 3_0,9_90 Ba Ct2	-87	-379	785	330	-207	4	813
3	SPLS 3_90 Ba Ct2	182	566	-2070	272	529	-28	-2143
4	SPLS 3_0,9_90 Ah Ct1	-364	734	2948	261	-776	16	3052

Maximale torsiebelasting (negatief)

Stijl	Combinatie	R_x [kN]	R_y [kN]	R_z [kN]	R_η [kN]	R_ξ [kN]	$R_{\xi,lok}$ [kN]	$R_{z,lok}$ [kN]
1	SPLS 3_0,9_90 Ba Ct1	358	729	2916	-262	-769	15	3020
2	SPLS 3_90 Ah Ct2	-188	571	-2100	-271	536	-28	-2174
3	SPLS 3_0,9_90 Ah Ct2	82	-383	811	-329	-213	5	840
4	SPLS 3_90 Ba Ct1	-264	-217	60	-340	-33	-17	62

Project: RLL-TLB380
 Masttype: HA+6_c
 Mast: 1078

Combinatie Ftrek+Fhor

Stijl	Combinatie	R _x [kN]	R _y [kN]	R _z [kN]	R _η [kN]	R _ξ [kN]	R _{ξ,lok} [kN]	R _{z,lok} [kN]
1	SPLS 3_0,9_90 Ah All Cts	-250	-441	-1956	135	488	-37	-2026
2	SPLS 3_0,9_80 Ah All Cts	-567	695	-3480	-91	892	-43	-3603
3	SPLS 3_0,9_100 Ba All Cts	561	689	-3448	90	884	-43	-3571
4	SPLS 3_0,9_0 Ba All Cts	284	-445	-2015	-114	516	-26	-2087

Permanente belasting

Stijl	Combinatie	R _x [kN]	R _y [kN]	R _z [kN]	R _η [kN]	R _ξ [kN]	R _{ξ,lok} [kN]	R _{z,lok} [kN]
1	SLS 7	220	185	1052	24	-287	-4	1089
2	SLS 7	-60	26	-289	24	61	-17	-299
3	SLS 7	60	26	-289	-24	61	-17	-299
4	SLS 7	-220	185	1052	-24	-287	-4	1089

Omhullenden ongeacht stijl

Belasting	Combinatie	R _x [kN]	R _y [kN]	R _z [kN]	R _η [kN]	R _ξ [kN]	R _{ξ,lok} [kN]	R _{z,lok} [kN]
Max. druk	SPLS 3_80 Ah All Cts	-719	848	4211	91	-1108	23	4360
Max. trek	SPLS 3_0,9_80 Ah All Cts	-567	695	-3480	-91	892	-43	-3603
Max. pos. torsie	SPLS 3_90 Ah Ct1	259	-221	35	339	-27	-18	36
Max. neg. torsie	SPLS 3_90 Ba Ct1	-264	-217	60	-340	-33	-17	62
Comb. trek+torsie	SPLS 3_0,9_80 Ah All Cts	-567	695	-3480	-91	892	-43	-3603

Maximale trekbelasting SLS

Stijl	Combinatie	R _x [kN]	R _y [kN]	R _z [kN]	R _η [kN]	R _ξ [kN]	R _{ξ,lok} [kN]	R _{z,lok} [kN]
1	SPLS 3_0,9_80 Ah All Cts	-247	-440	-1949	136	485	-39	-2018
2	SPLS 3_0,9_80 Ah All Cts	-567	695	-3480	-91	892	-43	-3603
3	SPLS 1a_0,9_100 Ba Ct2	256	582	-2291	231	593	-23	-2372
4	SPLS 3_0,9_100 Ba Ct2	119	95	-150	151	17	-24	-155

Maximale drukbelasting SLS

Stijl	Combinatie	R _x [kN]	R _y [kN]	R _z [kN]	R _η [kN]	R _ξ [kN]	R _{ξ,lok} [kN]	R _{z,lok} [kN]
1	SPLS 1a_100 Ba Ct2	710	443	3035	189	-815	1	3143
2	SPLS 3_100 Ba Ct2	-53	-406	948	325	-250	5	982
3	SPLS 3_80 Ah All Cts	-400	-592	2680	-136	-701	19	2776
4	SPLS 3_80 Ah All Cts	-719	848	4211	91	-1108	23	4360

Project: RLL-TLB380
Masttype: HA+6_c
Mast: 1078

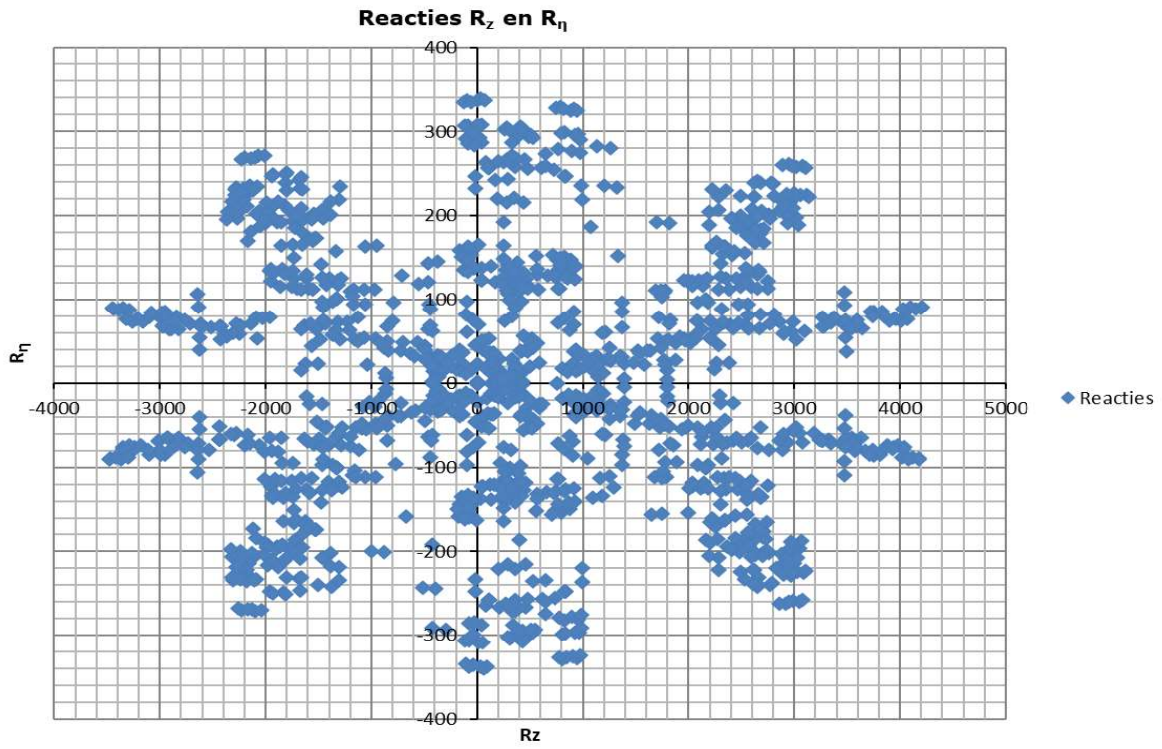

Project: RLL-TLB380
 Tower: HA+6_c - bouwfase
 Number: 1078

Auteur: TBR
 Versie: v12.0

Geleiderbelastingen

Algemeen

Benaming HA+6_c - bouwfase
 Masttype Hoekmast
 Aantal circuits 2
 Configuratie 2-circuit-verticaal
 Aantal bliksemgeleiders 1

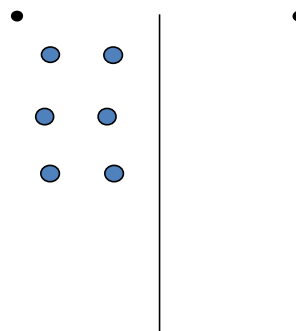

Configuratie geleiders

Uitgangspunten

Norm NEN-EN50341-2-15:2019
 Gevolgklasse initieel CC2
 Betrouwbaarheidsniveau initieel Nieuwbouw
 Referentieperiode initieel 15 jaar
 CC2
 Betrouwbaarheidsniveau na aanpassing n.v.t.
 15 jaar
 Windgebied III
 Windsnelheid (m/s) 24,5 m/s
 Terreincategorie II
 Reductiefactor C_{dir} 1,00
 IJsgebied fasegeleider B
 IJsgebied bliksemgeleider A

Geleiders Back

Omschrijving	Spanning	Geleider Back	Bundel Ba	IJsgebied	Toeslag gewicht	Toeslag diameter	Intrekwaarden P_{back}
Circuit 1	380 kV	AAAC-AL7 620	4	B	3 %	3 %	1800
Circuit 2	150 kV	AAAC-AL7 620	2	B	3 %	3 %	1800
Bliksemdraad 1		AACSR 241-AL3-39-A20SA	1	A	2 %	2 %	1800

Geleiders Ahead

Omschrijving	Spanning	Geleider Ahead	Bundel Ah	IJsgebied	Toeslag gewicht	Toeslag diameter	Intrekwaarden P_{ahead}
Circuit 1	380 kV	AAAC-AL7 620	4	B	3 %	3 %	1800
Circuit 2	150 kV	AAAC-AL7 620	2	B	3 %	3 %	1800
Bliksemdraad 1		AACSR 241-AL3-39-A20SA	1	A	2 %	2 %	1800

Isolatoren (1)

Omschrijving	Ophanging	Gewicht [kN]	Lengte [m]	Windopp. [m ²]
Circuit 1	Afspanketting	3,00	6,50	1,10
Circuit 2	Afspanketting	3,00	6,50	1,10
Bliksemdraad 1	Afspanketting	0,10	0,20	0,10

1. Eigenschappen gelden voor geheel van de isolatorset

Ophanghoogte en positie in mast

Circuits	Aanduiding	Nummer	Ophanghoogte	Aangrijppunt	Positie in mast Horizontale afstand
Circuit 1	10	380ct1f1	54,0 m	54,0 m	-10,8 m
Circuit 1	11	380ct1f2	44,0 m	44,0 m	-14,3 m
Circuit 1	12	380ct1f3	34,5 m	34,5 m	-11,4 m
Circuit 2	20	150ct2f1	54,0 m	54,0 m	-4,3 m
Circuit 2	21	150ct2f2	44,0 m	44,0 m	-7,8 m
Circuit 2	22	150ct2f3	34,5 m	34,5 m	-4,9 m
Bliksemdraad 1	1	bl1	59,1 m	59,1 m	-16,2 m

Project: RLL-TLB380
 Tower: HA+6_c - bouwfase
 Number: 1078

Hoogteaanpassing naastgelegen masten (aanpassing wind- en weight span)

	Back	Ahead	
Verhoging voor windbelasting	12,0 m	6,0 m	(positief: omhoog)
Verlaging voor verticale belasting	-9,0 m	-6,0 m	(negatief: omlaag, grotere weight span)
Verlaging:	Niet in 0,9EG-combinaties		

Hoogteafwijking mastbeeld naastgelegen masten en richtingsverandering t.o.v. Lijnrichting

Circuits	Aanduiding	Nummer	Hoogteverschil		Richtingsverandering	
			Δh back	Δh ahead	Δy back	Δy ahead
Circuit 1	10	380ct1f1	0,0	0,0 m	0,0	0,0 m
Circuit 1	11	380ct1f2	0,0	0,0 m	0,0	0,0 m
Circuit 1	12	380ct1f3	0,0	0,0 m	0,0	0,0 m
Circuit 2	20	150ct2f1	0,0	0,0 m	0,0	0,0 m
Circuit 2	21	150ct2f2	0,0	0,0 m	0,0	0,0 m
Circuit 2	22	150ct2f3	0,0	0,0 m	0,0	0,0 m
Bliksemdraad 1	1	bl1	0,0	0,0 m	0,0	0,0 m

Lijn- en mastgegevens

	Back	Ahead
Ruling span $\sqrt{(\Sigma L^3)/\Sigma L}$	400,0	400,0 m
Lijnhoek β	160 °	
Rotatie mast t.o.v. bissectrice θ	0 °	
Vaklengte	400	400 m
Hoogte onderkant mast t.o.v. maaiveld	0,5 m	
Beschouwde windrichtingen	0 °	
Windrichtingen volgens:	45 °	
<i>Geleiderbelastingen</i>	90 °	
	135 °	
	80 °	
	100 °	

Windrichtingen gelden t.o.v. hoofdrichting mastconstructie, niet t.o.v. bissectrice.

Windrichtingen en positieve richtingen belastingen

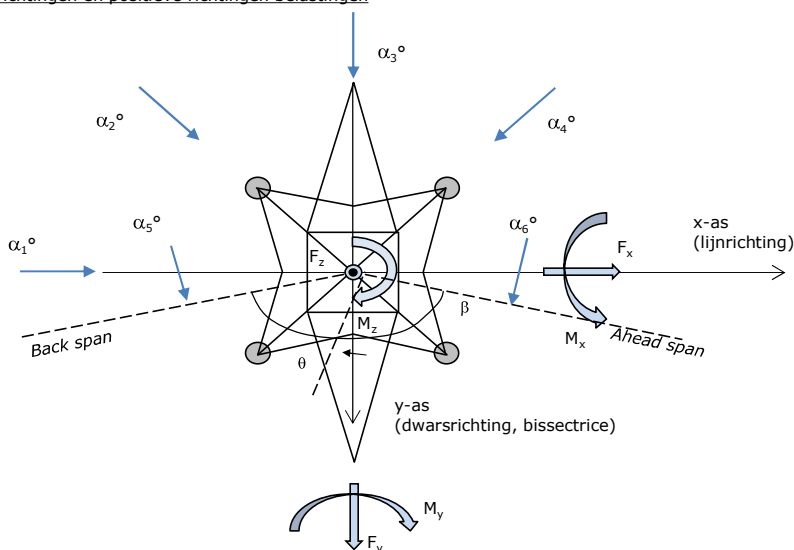

Beschouwd aantal windrichtingen

1a	6
3	6
4	1
6	1
Overig	1

Project: RLL-TLB380
 Tower: HA+6_c - bouwfase
 Number: 1078

Geleiderafval

		SPLS - torsie		SPLS - Enkelzijdige trek		5a - geleiderbreuk	
		Aanw.	Afw.	Aanw.	Afw.	Aanw.	Afw.
Circuit 1	380ct1f1	1	0	1	0	1	0
Circuit 1	380ct1f2	1	0	1	0	1	0
Circuit 1	380ct1f3	1	0	1	0	1	0
Circuit 2	150ct2f1	0	1	1	0	1	0
Circuit 2	150ct2f2	0	1	1	0	1	0
Circuit 2	150ct2f3	0	1	1	0	1	0
Bliksemdraad 1	bl1	1	0	1	0	1	0

Belastingsituaties SPLS

Beschouwde situaties SPLS: 1 t/m 6, alle mogelijke situaties.

Principe belastingssituaties:

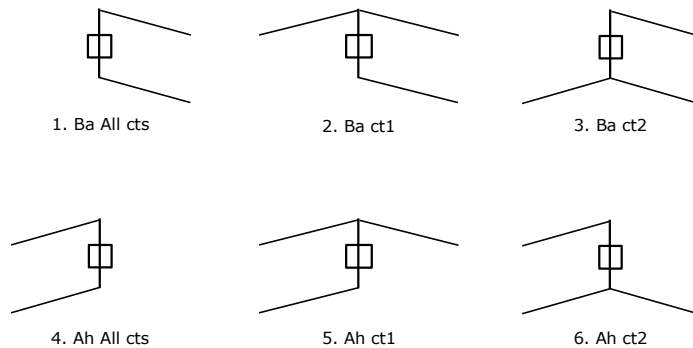

Belastingsituaties 5a. Geleiderbreuk

Beschouwde situaties geleiderbreuk 5a: 1 en 2, alle mogelijke situaties.

Principe belastingssituaties:

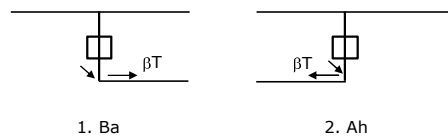

Project: RLL-TLB380
 Tower: HA+6_c - bouwfase
 Number: 1078

Belastingsituaties 6. Bouw- en onderhoud

Onder 6a wordt de belasting door aanwezigheid lijnwagen of lijnfiets in combinatie met puntlast op traverse in rekening gebracht. Combinatie 6b bevat geen belastingen in geleider of op traverse. Deze combinatie is toegevoegd om te kunnen combineren met separate controle bordessen etc. De situaties worden in ULS en in iedere SPLS-situatie (in geval van hoekmast) toegepast.

	Fase	Bliksem
Lijnwagen	4,0 kN	2,0 kN
Puntlast op traverse	1,0 kN	1,0 kN

Beschouwde situaties bouw- en onderhoud 6a: 1 t/m 4, alle mogelijke situaties.

Aanwezigheid lijnwagen: Circuit, belasting tegelijk aanwezig in alle geleiders per circuit.

Principe belastingssituaties:

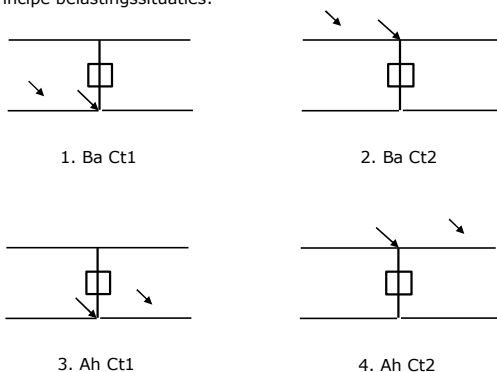

Belastingsituaties 8. Lijndansen als statische belasting

Geleider		
Steunmast fase	0,866 W	1,5 W
Steunmast bliksem	1,5 EDS	1,5 W
Hoekmast fase en bliksem	1,5 EDS	1,5 W

Beschouwde situaties lijndansen 8: 1 en 2, alle mogelijke situaties.

Belasting tegelijk aanwezig in alle geleiders van het circuit.

Principe belastingssituaties:

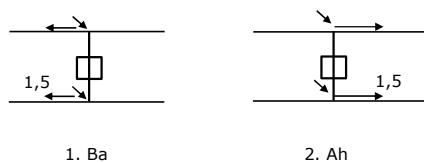

Belastingcombinatie 8. Lijndansen als dynamische belasting

Alleen van toepassing op hoek- en eindmasten

Belasting bestaat uit EDS-trekbelasting in één van de geleiders aan één zijde van de mast

Door gebruiker via het belastingspectrum van tabel 4.11/NL.1 om te zetten naar spanningspectrum

Project: RLL-TLB380
 Tower: HA+6_c - bouwfase
 Number: 1078

Mastconstructie

Eigenschappen

Masttype	Hoekmast	
Mastbenaming	HA+6_c - bouwfase	
Voetplaat t.o.v. maaiveld	0,5 m	
Masthoogte t.o.v. voetplaat	59,1 m	
Gewicht mast	1124,0 kN	
<i>Breedte en helling mast bij fundatie</i>		
	x-ri.	y-ri.
Pootsprei	14,04	14,04 m
Helling van de randstijl	0,190	0,190 -
Factor spatkracht	1,1	1,1 -

Berekening windbelasting

Dynamische invloed G_T	1,00 (Masthoogte < 60 m)
Windbelasting overhoeks op mastlichaam evenredig met:	$(A1C1\sin^2(\phi)+A2C2\cos^2(\phi))$
Windbelasting overhoeks op traverse evenredig met:	$(A1C1\sin^2(\phi)+A2C2\cos^2(\phi))$
Vergroting wind overhoeks mastlichaam	$(1+0,2\sin^2(2\phi))$
Vergroting wind overhoeks traverse	$(1+0,2\sin^2(2\phi))$
Factor wind evenwijdig t.o.v. haaks op traverse	0,4

Eigenschappen mastsecties langsrichting (vooraanzicht, yz-vlak)

Omschrijving	h [m]	b ₁ [m]	b ₂ [m]	Δh [m]	Δ _x [m]	A ₀ [m ²]	A ₁ [m ²]	χ = A ₁ /A ₀ [-]	C _t
Broekstuk	21,40	14,04	5,91	21,40	0,190	213,49	48,90	0,23	2,81
Eerste tussenstuk	28,20	5,91	5,23	6,80	0,050	37,88	13,24	0,35	2,37
Tweede tussenstuk	34,50	5,23	4,60	6,30	0,050	30,96	10,25	0,33	2,43
Bovenstuk 1	44,00	4,60	3,65	9,50	0,050	39,19	11,88	0,30	2,52
Bovenstuk 2	57,40	3,65	2,31	13,40	0,050	39,93	13,01	0,33	2,45
Topstuk	59,10	2,31		1,70		1,96	0,33	0,17	3,08
Ondertraverse	34,50	9,40		3,10		14,57	4,37	0,30	2,54
Middentraverse	44,00	12,78		3,20		20,45	6,34	0,31	2,50
Boventraverse	54,00	14,88		5,10		37,93	7,34	0,19	2,96

Eigenschappen mastsecties dwarsrichting (zijaanzicht, xz-vlak)

Omschrijving	h [m]	b ₁ [m]	b ₂ [m]	Δh [m]	Δ _x [m]	A ₀ [m ²]	A ₁ [m ²]	χ = A ₁ /A ₀ [-]	C _t
Broekstuk	21,40	14,04	5,91	21,40	0,190	213,49	48,90	0,23	2,81
Eerste tussenstuk	28,20	5,91	5,23	6,80	0,050	37,88	13,24	0,35	2,37
Tweede tussenstuk	34,50	5,23	4,60	6,30	0,050	30,96	10,25	0,33	2,43
Bovenstuk 1	44,00	4,60	3,65	9,50	0,050	39,19	11,88	0,30	2,52
Bovenstuk 2	57,40	3,65	2,31	13,40	0,050	39,93	13,01	0,33	2,45
Topstuk	59,10	2,31		1,70		1,96	0,33	0,17	3,08
Ondertraverse	34,50	9,40		3,10		14,57	4,37	0,30	2,54
Middentraverse	44,00	12,78		3,20		20,45	6,34	0,31	2,50
Boventraverse	54,00	14,88		5,10		37,93	7,34	0,19	2,96

NB: oppervlakte traverse dwarsrichting van de tabel wordt in berekening gereduceerd.
 NB: oppervlakte traverse per zijde, dus helft van totaal van twee traveses.

Project: RLL-TLB380
 Tower: HA+6_c - bouwfase
 Number: 1078

Windoppervlak feeders telecominstallaties

Onderdeel	A (m ² /m)	Factor	Δh	A ₁
Broekstuk	0,14	0,71	21,4	2,1
Eerste tussenstuk	0,14	0,71	6,8	0,7
Tweede tussenstuk	0,14	0,71	6,3	0,6
Bovenstuk 1	0,14	0,71	9,5	0,9
Bovenstuk 2				

Invoer antennes

Omschrijving	A (m ²)	h (m)	C _i (m)
Antenne top			
Antenne o.t.	4,7	40,7	1,5

Belastingen mastsectie langsrichting (x-richting) per windrichting

Omschrijving	P _w [kN/m ²]	F _{x1} [kN]	F _{x2} [kN]	F _{x3} [kN]	F _{x4} [kN]	h _{ef} [m]	M _{y1} [kNm]	M _{y2} [kNm]	M _{y3} [kNm]	M _{y4} [kNm]
Broekstuk	0,72	98,5	83,6	0,0	-83,6	10,7	1054,1	894,4	0,0	-894,4
Eerste tussenstuk	0,94	29,3	24,9	0,0	-24,9	24,8	727,4	617,3	0,0	-617,3
Tweede tussenstuk	1,00	24,9	21,1	0,0	-21,1	31,4	780,8	662,5	0,0	-662,5
Bovenstuk 1	1,07	32,0	27,2	0,0	-27,2	39,3	1257,3	1066,9	0,0	-1066,9
Bovenstuk 2	1,14	36,3	30,8	0,0	-30,8	50,7	1837,9	1559,5	0,0	-1559,5
Topstuk	1,18	1,2	1,0	0,0	-1,0	58,3	69,6	59,1	0,0	-59,1
Ondertraverse	1,04	22,9	13,6	0,0	-13,6	35,5	815,3	484,2	0,0	-484,2
Middentraverse	1,10	35,0	20,8	0,0	-20,8	45,1	1578,4	937,5	0,0	-937,5
Boventraverse	1,17	50,7	30,1	0,0	-30,1	55,7	2825,4	1678,2	0,0	-1678,2
Totaal		330,9	253,1	0,0	-253,1		10946,2	7959,6	0,0	-7959,6

Belastingen mastsectie dwarsrichting (y-richting) per windrichting

Omschrijving	P _w [kN/m ²]	F _{y1} [kN]	F _{y2} [kN]	F _{y3} [kN]	F _{y4} [kN]	h _{ef} [m]	M _{x1} [kNm]	M _{x2} [kNm]	M _{x3} [kNm]	M _{x4} [kNm]
Broekstuk	0,72	0,0	83,6	98,5	83,6	10,7	0,0	894,4	1054,1	894,4
Eerste tussenstuk	0,94	0,0	24,9	29,3	24,9	24,8	0,0	617,3	727,4	617,3
Tweede tussenstuk	1,00	0,0	21,1	24,9	21,1	31,4	0,0	662,5	780,8	662,5
Bovenstuk 1	1,07	0,0	27,2	32,0	27,2	39,3	0,0	1066,9	1257,3	1066,9
Bovenstuk 2	1,14	0,0	30,8	36,3	30,8	50,7	0,0	1559,5	1837,9	1559,5
Topstuk	1,18	0,0	1,0	1,2	1,0	58,3	0,0	59,1	69,6	59,1
Ondertraverse	1,04	0,0	13,6	9,2	13,6	35,5	0,0	484,2	326,1	484,2
Middentraverse	1,10	0,0	20,8	14,0	20,8	45,1	0,0	937,5	631,3	937,5
Boventraverse	1,17	0,0	30,1	20,3	30,1	55,7	0,0	1678,2	1130,2	1678,2
Totaal		0,0	253,1	265,7	253,1		0,0	7959,6	7814,8	7959,6

Resulterende belastingen vanuit mastconstructie incl. antenne zonder geleiders niveau fundatie (kar. waarde)

Belasting / windrichting	F _x [kN]	F _y [kN]	F _z [kN]	M _x [kNm]	M _y [kNm]	M _z [kNm]
Permanente belasting	0	0	1124	0	0	0
Windrichting 0°	339	0	0	0	11255	0
Windrichting 45°	258	258	0	8178	8178	0
Windrichting 90°	0	273	0	8123	0	0
Windrichting 135°	-258	258	0	8178	-8178	0

Project: RLL-TLB380
 Tower: HA+6_c - bouwfase
 Number: 1078

Tussenresultaten geleiderbelastingen

Geleiders back

Circuit	Geleider	Diameter [mm]	A [mm ²]	G [N/m]	E [N/mm ²]	αT [-]
Circuit 1	AAAC-AL7 620	32,4	621,0	17,71	56000	2,30E-05
Circuit 2	AAAC-AL7 620	32,4	621,0	17,71	56000	2,30E-05
Bliksemdraad 1	AACSR 241-AL3-39-A20SA	21,8	281,0	9,38	70165	1,97E-05

Geleiders ahead

Circuit	Geleider	Diameter [mm]	A [mm ²]	G [N/m]	E [N/mm ²]	αT [-]
Circuit 1	AAAC-AL7 620	32,4	621,0	17,71	56000	2,30E-05
Circuit 2	AAAC-AL7 620	32,4	621,0	17,71	56000	2,30E-05
Bliksemdraad 1	AACSR 241-AL3-39-A20SA	21,8	281,0	9,38	70165	1,97E-05

Verticale belasting back

Circuit	Bundel [-]	Toeslag [%]	$W_{z,G}$ [N/m]	IJsgebied	Formule	$W_{z,ijs}$ [N/m]	$W_{z,ijs,bundel}$ [N/m]
Circuit 1	4	3	73,0	B	4+0,2d	10,5	41,9
Circuit 2	2	3	36,5	B	4+0,2d	10,5	21,0
Bliksemdraad 1	1	2	9,6	A	15+0,4d	23,7	23,7

Verticale belasting ahead

Circuit	Bundel [-]	Toeslag [%]	$W_{z,G}$ [N/m]	IJsgebied	Formule	$W_{z,ijs}$ [N/m]	$W_{z,ijs,bundel}$ [N/m]
Circuit 1	4	3	73,0	B	4+0,2d	10,5	41,9
Circuit 2	2	3	36,5	B	4+0,2d	10,5	21,0
Bliksemdraad 1	1	2	9,6	A	15+0,4d	23,7	23,7

Isolatoren

Geleider	$G_{isolator}$ [kN]	Aantal	$F_{v,iso}$ [kN]	Lengte [m]	Windopp. [m ²]	Windhoogte [m]	Stuwdruk [kN/m ²]	Vormfactor [-]	$F_{h,iso}$ [kN]
380ct1f1	3,00	1	3	6,5	1,1	54,50	1,16	1,2	1,53
380ct1f2	3,00	1	3	6,5	1,1	44,50	1,10	1,2	1,45
380ct1f3	3,00	1	3	6,5	1,1	35,00	1,03	1,2	1,36
150ct2f1	3,00	1	3	6,5	1,1	54,50	1,16	1,2	1,53
150ct2f2	3,00	1	3	6,5	1,1	44,50	1,10	1,2	1,45
150ct2f3	3,00	1	3	6,5	1,1	35,00	1,03	1,2	1,36
bl1	0,10	1	0,1	0,2	0,1	59,60	1,19	1,2	0,14

Project: RLL-TLB380
 Tower: HA+6_c - bouwfase
 Number: 1078

Windbelasting back

Geleider	hoogte		G_{c_dwars}	G_{c_trek}	C_c	$d_{toeslag}$	W_y	$W_{y,vak}$	$D_{ijs,toeslag}$	$W_{y,ijs}$	$W_{y,ijs,vak}$
	wind [m]	Stuwdruk [kN/m ²]									
380ct1f1	53,1	1,15	0,62	0,68	0,95	33,37	91,4	100,4	51,8	178,5	196,2
380ct1f2	43,1	1,09	0,61	0,67	0,97	33,37	85,9	94,5	51,8	164,5	181,0
380ct1f3	33,6	1,02	0,59	0,65	1,00	33,37	79,5	87,5	51,8	148,8	163,8
150ct2f1	53,1	1,15	0,62	0,68	0,95	33,37	45,7	50,2	51,8	89,2	98,1
150ct2f2	43,1	1,09	0,61	0,67	0,97	33,37	42,9	47,2	51,8	82,3	90,5
150ct2f3	33,6	1,02	0,59	0,65	1,00	33,37	39,7	43,7	51,8	74,4	81,9
bl1	58,2	1,18	0,63	0,69	1,18	22,24	19,4	21,3	63,1	56,3	61,8

Windbelasting ahead

Geleider	hoogte		G_{c_dwars}	G_{c_trek}	C_c	$d_{toeslag}$	W_y	$W_{y,vak}$	$D_{ijs,toeslag}$	$W_{y,ijs}$	$W_{y,ijs,vak}$
	wind [m]	Stuwdruk [kN/m ²]									
380ct1f1	50,1	1,14	0,62	0,68	0,96	33,37	89,8	98,8	51,8	174,5	191,9
380ct1f2	40,1	1,07	0,60	0,66	0,98	33,37	84,0	92,4	51,8	159,9	175,9
380ct1f3	30,6	0,99	0,58	0,64	1,00	33,37	77,1	84,9	51,8	143,2	157,6
150ct2f1	50,1	1,14	0,62	0,68	0,96	33,37	44,9	49,4	51,8	87,3	95,9
150ct2f2	40,1	1,07	0,60	0,66	0,98	33,37	42,0	46,2	51,8	79,9	88,0
150ct2f3	30,6	0,99	0,58	0,64	1,00	33,37	38,6	42,4	51,8	71,6	78,8
bl1	55,2	1,17	0,62	0,69	1,18	22,24	19,1	21,0	63,1	55,2	60,6

NB: belastingen w_v gelden voor bundel

Project: RLL-TLB380
 Masttype: HA+6_c - bouwfase
 Mast: 1078

Auteur: TBR
 Versie: v12.0

Geleiderbelastingen

Uitgangspunten
 Betrouwbaarheidsniveau Nieuwbouw CC2
 Referentieperiode 15 jaar

ULS (bezwijksterkte)		NEN-EN50341-2-15:2019							
Belastingsgeval	omschrijving	Temp °C	γ_G		γ_Q			γ_a A_k	
			$G_{k,mast}$	$G_{k,geleider}$	Q_{pk}	Q_{wk}	Q_{ik}		
ULS 1a	Wind	10°	1,20	1,20	0,00	1,25	0,00	0,0	
ULS 1a_0,9	Wind 0,9Gk alleen mast	10°	0,90	1,20	0,00	1,25	0,00	0,0	
ULS 1a_0,9_0,9	Wind 0,9Gk ook geleider	10°	0,90	0,90	0,00	1,25	0,00	0,0	
ULS 3	Wind+ijs	-5°	1,20	1,20	0,00	0,38	1,07	0,0	
ULS 3_0,9	Wind+ijs 0,9	-5°	0,90	1,20	0,00	0,38	1,07	0,0	
ULS 4	Koude+wind	-20°	1,20	1,20	0,00	0,25	0,00	0,0	
ULS 4_0,9	Koude+wind 0,9	-20°	0,90	1,20	0,00	0,25	0,00	0,0	
ULS 5a	Torsiebelastingen	10°	1,00	1,00	1,00	0,00	0,00	1,0	
ULS 5b	Longitudinale belastingen	10°	1,00	1,00	0,00	0,00	0,00	1,0	
ULS 6	Bouw en onderhoud	5°	1,20	1,20	1,50	0,25	0,00	0,0	
ULS 6_0,9	Bouw en onderhoud	5°	1,20	1,20	0,00	0,25	0,00	0,0	
ULS 7	Permanent	10°	1,35	1,35	0,00	0,00	0,00	0,0	
ULS 8	Special	10°	1,00	1,00	0,00	0,00	0,00	1,0	
SPLS (Bezwijksterkte, enkel voor hoekmasten: afwezigheid geleiders)				γ_G G_k	γ_Q Q_{pk} Q_{wk} Q_{ik}			A_k	
SPLS 1a	Wind	10°	1,20	1,20	0,0	0,78	0,00	0,0	
SPLS 1a_0,9	Wind 0,9	10°	0,90	1,20	0,0	0,78	0,00	0,0	
SPLS 1a_0,9_0,9	Wind 0,9	10°	0,90	0,90	0,0	0,78	0,00	0,0	
SPLS 3	Wind+ijs	-5°	1,20	1,20	0,0	0,36	0,34	0,0	
SPLS 3_0,9	Wind+ijs 0,9	-5°	0,90	1,20	0,0	0,36	0,34	0,0	
SPLS 4	Koude+wind	-20°	1,20	1,20	0,0	0,24	0,00	0,0	
SPLS 4_0,9	Koude+wind 0,9	-20°	0,90	1,20	0,0	0,24	0,00	0,0	
SPLS 6	Bouw en onderhoud	5°	1,20	1,20	1,2	0,24	0,0	0,0	
SPLS 6_0,9	Bouw en onderhoud	5°	1,20	1,20	0,0	0,24	0,0	0,0	
SLS (controle van de vervormingen, vermoeiing, EDS)				G_k	Q_{pk}	Q_{wk}	Q_{ik}	A_k	
SLS 1a	Wind	10°	1,00	1,00	0,0	0,87	0,0	0,0	
SLS 3	Wind+ijs	-5°	1,00	1,00	0,0	0,26	0,71	0,0	
SLS 4	Wind	-20°	1,00	1,00	0,0	0,17	0,0	0,0	
SLS 6	Bouw en onderhoud	5°	1,00	1,00	0,0	0,17	0,0	0,0	
SLS 7	PB (EDS, geen wind)	10°	1,00	1,00	0,0	0,00	0,0	0,0	

Aantal windrichtingen 6
 Aantal belastingcombinaties ULS 68
 Aantal belastingcombinaties SPLS 222
 Aantal belastingcombinaties SLS 15
 Aantal knooplasten 5185

Project: RLL-TLB380
 Masttype: HA+6_c - bouwfase
 Mast: 1078

Samenvattingstabellen geleiderbelastingen

In de onderstaande vier tabellen is weergegeven:

- De maximale geleiderbelasting in het globale assenstelsel, gesplitst in aandeel van back en ahead span
- De gecombineerde geleiderbelasting (Ba+Ah) in het globale assenstelsel met in het lokale assenstelsel de maximaal optredende trekkracht. Componenten Fx en Fy als absolute waarde
- De alledaagse (EDS) waarden van de gecombineerde geleiderbelastingen (Ba+Ah) met bijbehorende trekkrachten
- Controle op uplift, waar een negatieve waarde duidt op uplift

Maximale waarden voor back en ahead span

Geleider	Fx_ba [kN]	Fx_ah [kN]	Fy_ba [kN]	Fy_ah [kN]	Fz_ba [kN]	Fz_ah [kN]
bl1	-54,0	53,8	13,9	13,7	8,2	7,8
380ct1f1	-239,7	238,8	65,4	64,7	35,6	33,8
380ct1f2	-236,6	235,7	62,8	61,9	35,5	33,7
380ct1f3	-233,4	232,4	59,8	58,7	35,5	33,7
Post-isolato	0,0	0,0	0,0	0,0	0,0	
Post-isolato	0,0	0,0	0,0	0,0	0,0	
Post-isolato	0,0	0,0	0,0	0,0	0,0	
150ct2f1	-119,8	119,3	33,7	33,3	22,5	21,6
150ct2f2	-118,3	117,8	32,4	31,9	22,5	21,6
150ct2f3	-116,7	116,1	30,8	30,3	22,5	21,6

Min. Weight span (m)

Weight spar Combinatie1

Geleider	SLS 1a	SLS 4	SLS 7
bl1	467,6	480,7	467,5
380ct1f1	467,5	480,0	467,5
380ct1f2	467,5	479,8	467,5
380ct1f3	467,5	479,6	467,5
Post-isolator 1			
Post-isolator 2			
Post-isolator 3			
150ct2f1	467,5	480,0	467,5
150ct2f2	467,5	479,8	467,5
150ct2f3	467,5	479,6	467,5

Max. Weight span (m)

Weight spar Combinatie1

Geleider	ULS 1a	ULS 3
bl1	532,3	460,2
380ct1f1	499,2	469,1
380ct1f2	496,2	468,2
380ct1f3	492,6	467,3
Post-isolator 1		
Post-isolator 2		
Post-isolator 3		
150ct2f1	499,2	469,1
150ct2f2	496,2	468,2
150ct2f3	492,6	467,3

Omhullende weight span over alle combinaties (incl. 0,9 combinaties)

Voor alle geleiders

		Wind / Weight span verhouding
Max. weight span	532,3 m	1,331 -
Min. weight span	194,1 m	0,485 -

Project: RLL-TLB380
 Masttype: HA+6_c - bouwfase
 Mast: 1078

Maximale waarden back+ahead span Maximale waarden trekkracht geleider

Geleider	Fx	Fy	Fz	Ft_ba	Ft_ah
	[kN]	[kN]	[kN]	[kN]	[kN]
bl1	39,2	27,2	8,2	-55,6	55,3
380ct1f1	206,9	127,4	35,6	-245,8	244,9
380ct1f2	203,1	122,2	35,5	-242,6	241,5
380ct1f3	199,0	116,1	35,5	-239,1	237,9
Post-isolato	3,7	3,7	6,8	0,0	
Post-isolato	2,8	2,8	4,7	0,0	
Post-isolato	4,2	4,2	6,8	0,0	
150ct2f1	108,3	65,5	22,5	-122,9	122,4
150ct2f2	108,2	63,0	22,5	-121,3	120,8
150ct2f3	108,1	59,9	22,5	-119,6	119,0

EDS-belastingen geleiders

Geleider	Fx	Fy	Fz	Ft_ba	Ft_ah
	[kN]	[kN]	[kN]	[kN]	[kN]
bl1	17,0	3,0	2,4	-17,2	17,2
380ct1f1	129,3	22,8	20,5	-131,3	131,3
380ct1f2	129,3	22,8	20,5	-131,3	131,3
380ct1f3	129,3	22,8	20,5	-131,3	131,3
Post-isolato	0,0	0,0	5,0	0,0	
Post-isolato	0,0	0,0	3,5	0,0	
Post-isolato	0,0	0,0	5,0	0,0	
150ct2f1	64,7	11,4	11,8	-65,7	65,7
150ct2f2	64,7	11,4	11,8	-65,7	65,7
150ct2f3	64,7	11,4	11,8	-65,7	65,7

Controle uplift SLS-wind

Combinatie: Geleider	Fz_ba	Fz_ah
	[kN]	[kN]
SLS 4 bl1	0,0	0,0
380ct1f1	0,0	0,0
380ct1f2	0,0	0,0
380ct1f3	0,0	0,0
Post-isolato	0,0	
Post-isolato	0,0	
Post-isolato	0,0	
150ct2f1	0,0	0,0
150ct2f2	0,0	0,0
150ct2f3	0,0	0,0

Project: RLL-TLB380
 Masttype: HA+6_c - bouwfase
 Mast: 1078

ULS-fundatiebelasting combinatie 1 en 3 wind haaks op de lijn of bissectrice en EDS, vanuit geleiders

Combinatie	Combination	F_x [kN]	F_y [kN]	F_z [kN]	M_x [kNm]	M_y [kNm]	M_z [kNm]
ULS 1a_90		-11	588	261	23872	-470	111
ULS 1a_0,9_0		12	245	186	9058	529	-143
ULS 1a_0,9_0,9_90		-12	565	122	24236	-528	125
ULS 3_0		4	364	351	12743	173	-46
SLS 7		0	211	208	7321	0	0

ULS-fundatiebelasting combinatie 1 en 3 wind haaks op de lijn of bissectrice en EDS, totaal geleiders en mast

Combinatie	F_x [kN]	F_y [kN]	F_z [kN]	M_x [kNm]	M_y [kNm]	M_z [kNm]
ULS 1a_90	-11	931	1610	34051	-470	111
ULS 1a_0,9_0,9_90	-12	907	1134	34415	-528	125
SLS 7	0	211	1332	7321	0	0

Fundatiebelastingen, selectie belastingcombinaties op basis grootste waarde

Combinatie	F_x [kN]	F_y [kN]	F_z [kN]	M_x [kNm]	M_y [kNm]	M_z [kNm]
ULS 1a_0,9_90	-11	931	1182	34987	-470	111
SPLS 3_90 Ah All Cts	-946	303	1525	10366	-42466	9697
SPLS 3_80 Ah All Cts	-934	307	1525	10502	-42216	9758
SPLS 1a_0,9_90 Ah All Cts	-844	445	1122	15646	-37812	8619

Noot: grootste waarden kunnen in meerdere combinaties voorkomen, een combinatie is weergegeven.

Oplegreacties op fundering per randstijl

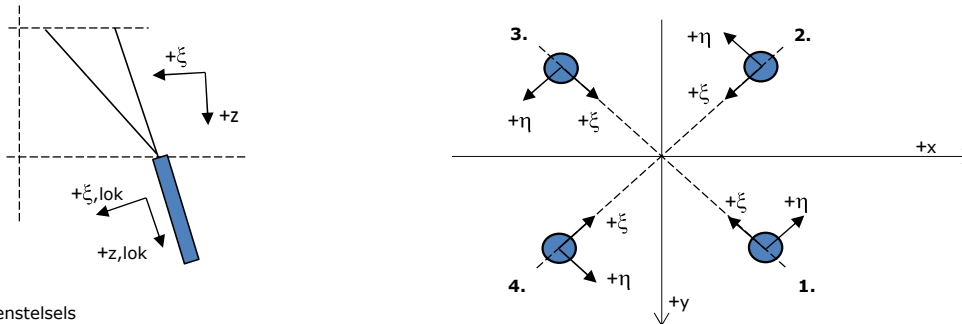

Assenstelsels

Maximale drukbelasting

Stijl	Combinatie	R_x [kN]	R_y [kN]	R_z [kN]	R_η [kN]	R_ξ [kN]	$R_{\xi,lok}$ [kN]	$R_{z,lok}$ [kN]
1	SPLS 3_90 Ba All Cts	220	640	2252	-297	-608	-3	2332
2	SPLS 3_0 Ba All Cts	434	-199	1678	-166	-447	3	1737
3	ULS 8 Ba	-424	-167	1601	182	-418	12	1658
4	SPLS 1a_90 Ah All Cts	-249	625	2262	266	-618	-10	2343

Maximale trekbelasting

Stijl	Combinatie	R_x [kN]	R_y [kN]	R_z [kN]	R_η [kN]	R_ξ [kN]	$R_{\xi,lok}$ [kN]	$R_{z,lok}$ [kN]
1	ULS 8 Ba	44	-350	-921	279	217	-31	-953
2	SPLS 1a_0,9_90 Ah All Cts	-422	181	-1623	171	426	-10	-1681
3	SPLS 1a_0,9_90 Ba All Cts	417	178	-1602	-169	421	-9	-1659
4	SPLS 3_0,9_0 Ba All Cts	-11	-362	-1001	-264	249	-20	-1036

Maximale torsiebelasting (positief)

Stijl	Combinatie	R_x [kN]	R_y [kN]	R_z [kN]	R_η [kN]	R_ξ [kN]	$R_{\xi,lok}$ [kN]	$R_{z,lok}$ [kN]
1	SPLS 3_0,9_80 Ah All Cts	82	-352	-826	307	191	-31	-855
2	SPLS 3_0,9_80 Ah All Cts	-431	158	-1615	193	416	-18	-1672
3	SPLS 3_80 Ah All Cts	-409	-143	1510	188	-390	15	1564
4	SPLS 3_80 Ah All Cts	-218	644	2258	302	-609	-3	2338

Maximale torsiebelasting (negatief)

Index	Combinatie	R_x [kN]	R_y [kN]	R_z [kN]	R_η [kN]	R_ξ [kN]	$R_{\xi,lok}$ [kN]	$R_{z,lok}$ [kN]
1	SPLS 3_100 Ba All Cts	217	640	2247	-299	-606	-2	2327
2	SPLS 3_100 Ba All Cts	406	-143	1499	-186	-388	15	1552
3	SPLS 3_0,9_100 Ba All Cts	426	156	-1593	-191	411	-17	-1650
4	SPLS 3_0,9_100 Ba All Cts	-81	-349	-821	-304	189	-31	-850

Project: RLL-TLB380
 Masttype: HA+6_c - bouwfase
 Mast: 1078

Combinatie Ftrek+Fhor

Stijl	Combinatie	R _x [kN]	R _y [kN]	R _z [kN]	R _η [kN]	R _ξ [kN]	R _{ξ,lok} [kN]	R _{z,lok} [kN]
1	ULS 8 Ba	44	-350	-921	279	217	-31	-953
2	SPLS 3_0,9_90 Ah All Cts	-431	160	-1618	192	418	-17	-1676
3	SPLS 3_0,9_90 Ba All Cts	426	158	-1598	-190	413	-16	-1655
4	SPLS 3_0,9_0 Ba All Cts	-11	-362	-1001	-264	249	-20	-1036

Permanente belasting

Stijl	Combinatie	R _x [kN]	R _y [kN]	R _z [kN]	R _η [kN]	R _ξ [kN]	R _{ξ,lok} [kN]	R _{z,lok} [kN]
1	SLS 7	124	122	594	1	-174	-15	615
2	SLS 7	15	-17	72	1	-23	-3	75
3	SLS 7	-15	-17	72	-1	-23	-3	75
4	SLS 7	-124	122	594	-1	-174	-15	615

Omhullenden ongeacht stijl

Belasting	Combinatie	R _x [kN]	R _y [kN]	R _z [kN]	R _η [kN]	R _ξ [kN]	R _{ξ,lok} [kN]	R _{z,lok} [kN]
Max. druk	SPLS 1a_90 Ah All Cts	-249	625	2262	266	-618	-10	2343
Max. trek	SPLS 1a_0,9_90 Ah All Cts	-422	181	-1623	171	426	-10	-1681
Max. pos. torsie	SPLS 3_0,9_80 Ah All Cts	82	-352	-826	307	191	-31	-855
Max. neg. torsie	SPLS 3_0,9_100 Ba All Cts	-81	-349	-821	-304	189	-31	-850
Comb. trek+torsie	SPLS 3_0,9_90 Ah All Cts	-431	160	-1618	192	418	-17	-1676

Maximale trekbelasting SLS

Stijl	Combinatie	R _x [kN]	R _y [kN]	R _z [kN]	R _η [kN]	R _ξ [kN]	R _{ξ,lok} [kN]	R _{z,lok} [kN]
1	SPLS 3_0,9_100 Ah All Cts	72	-349	-837	298	196	-29	-867
2	SPLS 1a_0,9_100 Ah All Cts	-420	184	-1615	167	427	-7	-1673
3	SPLS 1a_0,9_100 Ba Ct2	191	141	-883	-36	235	-3	-914
4	SLS 1a_0	-51	45	234	-4	-68	-5	242

Maximale drukbelasting SLS

Stijl	Combinatie	R _x [kN]	R _y [kN]	R _z [kN]	R _η [kN]	R _ξ [kN]	R _{ξ,lok} [kN]	R _{z,lok} [kN]
1	SPLS 1a_100 Ba Ct2	267	346	1544	-56	-434	-19	1599
2	SLS 1a_0	92	-90	432	-1	-129	-13	448
3	SPLS 3_100 Ah All Cts	-410	-149	1522	184	-396	13	1576
4	SPLS 3_80 Ah All Cts	-218	644	2258	302	-609	-3	2338

Project: RLL-TLB380
Masttype: HA+6_c - bouwfase
Mast: 1078

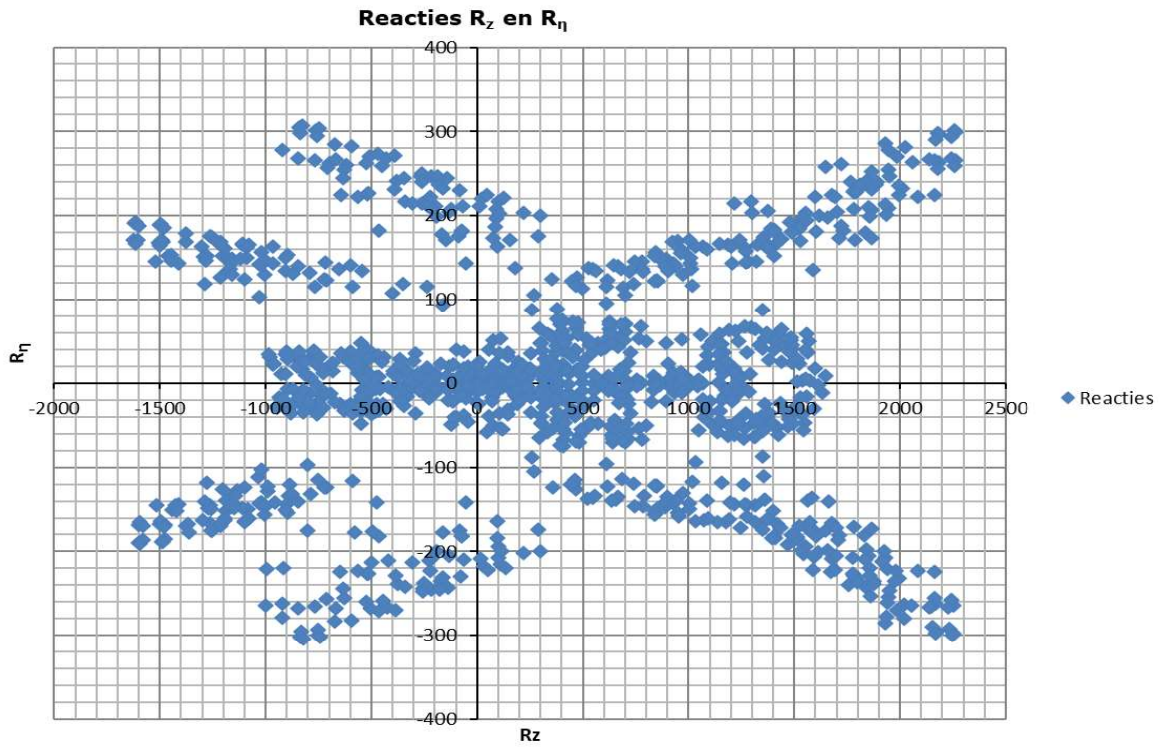

Belastinggeval - afspannen

Date: 2021-05-10
 Author: TBR
 Version: 1.1

RLL-TLB
 HA+6_c (afspannen)

Invoergegevens

Hoogteafwijking mastbeeld naastgelegen masten en richtingsverandering t.o.v. Lijnrichting

Circuits	Aanduiding	Nummer	Hoogteverschil		Richtingsverandering	
			Dh_back	Dh_ahead	Dy_back	Dy_ahead
Circuit 1	10	380ct1f1	0,0	-9,0 m	0,0	0,0 m
Circuit 1	11	380ct1f2	0,0	-9,0 m	0,0	0,0 m
Circuit 1	12	380ct1f3	0,0	-9,0 m	0,0	0,0 m
Circuit 2	13	380ct2f1	-54,0	0,0 m	0,0	0,0 m
Circuit 2	14	380ct2f2	-38,0	0,0 m	0,0	0,0 m
Circuit 2	15	380ct2f3	-28,5	0,0 m	0,0	0,0 m
Circuit 3	20	150ct3f1	0,0	-9,0 m	0,0	0,0 m
Circuit 3	21	150ct3f2	0,0	-9,0 m	0,0	0,0 m
Circuit 3	22	150ct3f3	0,0	-9,0 m	0,0	0,0 m
Circuit 4	23	150ct4f1	-54,0	0,0 m	0,0	0,0 m
Circuit 4	24	150ct4f2	-38,0	0,0 m	0,0	0,0 m
Circuit 4	25	150ct4f3	-28,5	0,0 m	0,0	0,0 m
Bliksemdraad 1	1	bl1	0,0	-9,0 m	0,0	0,0 m
Bliksemdraad 2	3	bl2	-59,1	0,0 m	0,0	0,0 m

Lijn- en mastgegevens

		Back	Ahead
Ruling span $\sqrt{(SL3/SL)}$		82,5	400,0 m
Lijnhoek	β	180 °	
Rotatie mast t.o.v. bissectrice	θ	-10 °	
Vaklengte		83	400 m
Hoogte onderkant mast t.o.v. maaiveld		0,5 m	
Beschouwde windrichtingen	a1	0 °	
Windrichtingen volgens:	a2	45 °	
<i>Geleiderbelastingen</i>	a3	90 °	
	a4	135 °	
	a5	100 °	
	a6	100 °	

Windrichtingen gelden t.o.v. hoofdrichting mastconstructie, niet t.o.v. bissectrice.

In onderstaande tabel zijn de optredende belastingen weergegeven, voor deze situatie geldt:

- belasting op geleider1, 10 t/m 12 en 20 t/m 22 zijn permanent aanwezig
- van de belasting op de overige geleiders is er telkens één aanwezig per belastingcombinatie

Uitvoer geleiderbelastingen

Belastingcombi	nummer	Fxtotaal	Fytotaal	Fztotaal	Ftrekahead	Ftrekback
ULS 6b_90	10	156,3	32,5	24,7	159,5	0,0
	11	155,7	32,0	24,7	158,9	0,0
	12	155,1	31,4	24,7	158,2	0,0
	1	21,2	4,7	2,9	21,7	0,0
	20	78,1	16,3	13,0	79,8	0,0
	21	77,8	16,1	12,9	79,5	0,0
	22	77,5	15,8	12,9	79,1	0,0
	3	-19,4	-3,2	14,7	0,0	-19,7
	13	-147,7	-24,9	105,2	0,0	-149,8
	14	-147,6	-24,9	76,2	0,0	-149,7
	15	-147,5	-24,9	58,9	0,0	-149,6
	23	-73,9	-12,3	53,2	0,0	-74,9
	24	-73,8	-12,4	38,7	0,0	-74,9
	25	-73,8	-12,4	30,0	0,0	-74,8

APPENDIX B

Resultaten PLS-TOWER

Deze Appendix bevat de resultaten uit PLS-TOWER voor de verschillende masttypen. De samenstelling van de bovenstukken zijn voor alle masttypen gelijk. De resultaten van het bovenstuk zijn dan ook alleen opgenomen van het maatgevende masttype HA+6/c. De resultaten van het onderstuk zijn voor alle masten opgenomen.

Resultaten opgenomen voor:

- Masttype HA+0/c
- Masttype HA+3/c
- Masttype HA+6/c

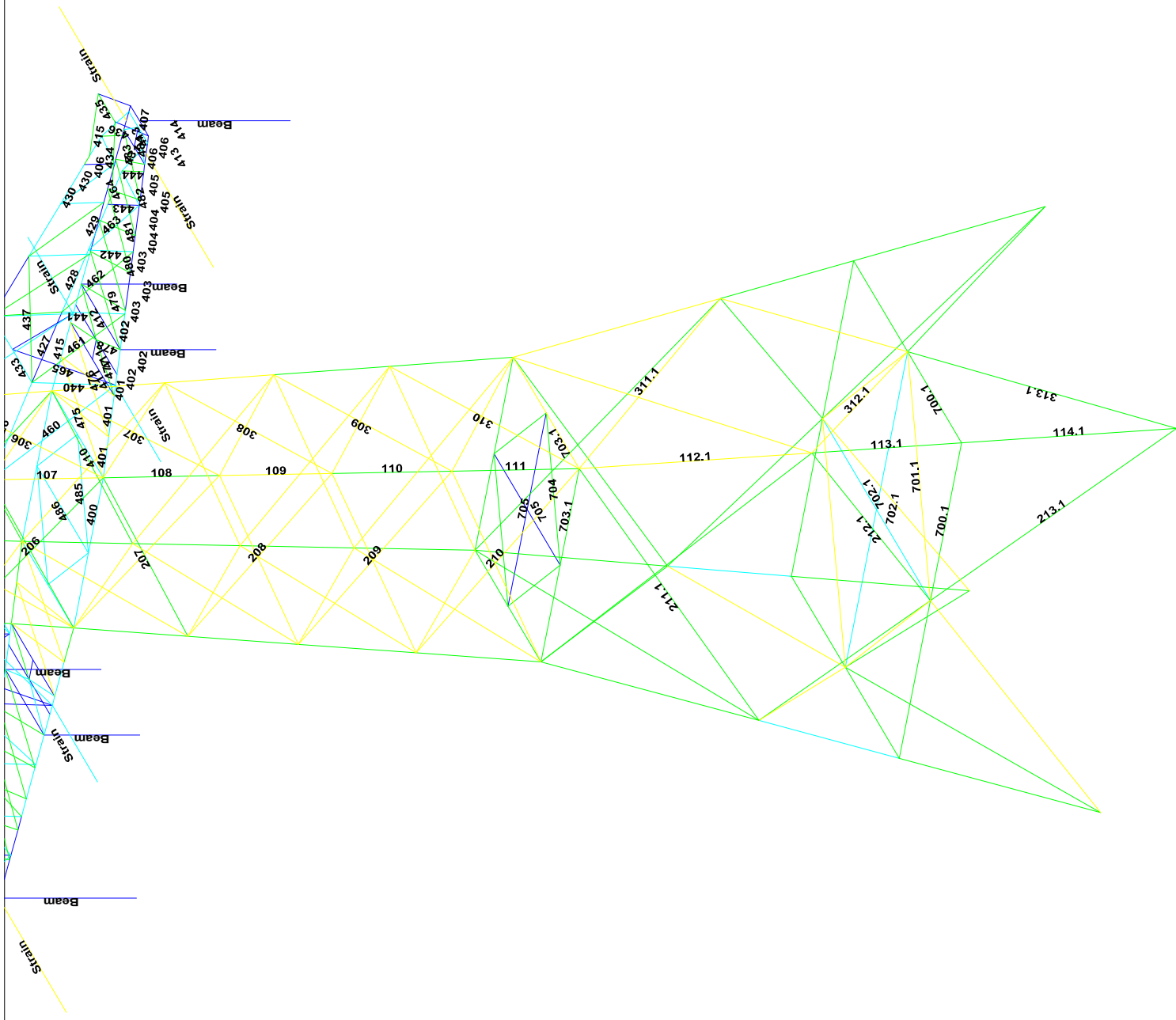

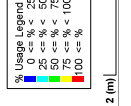
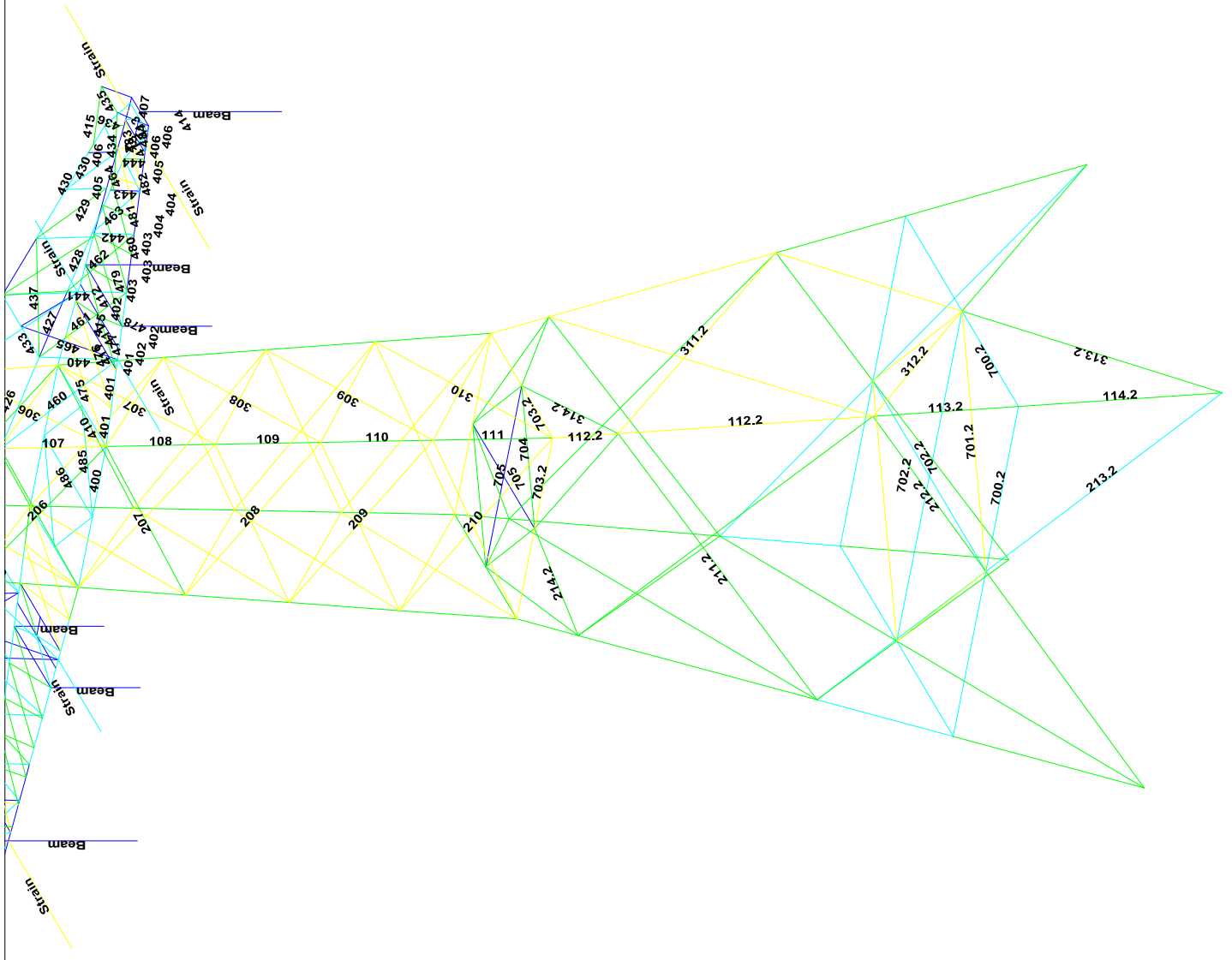

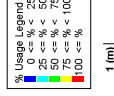
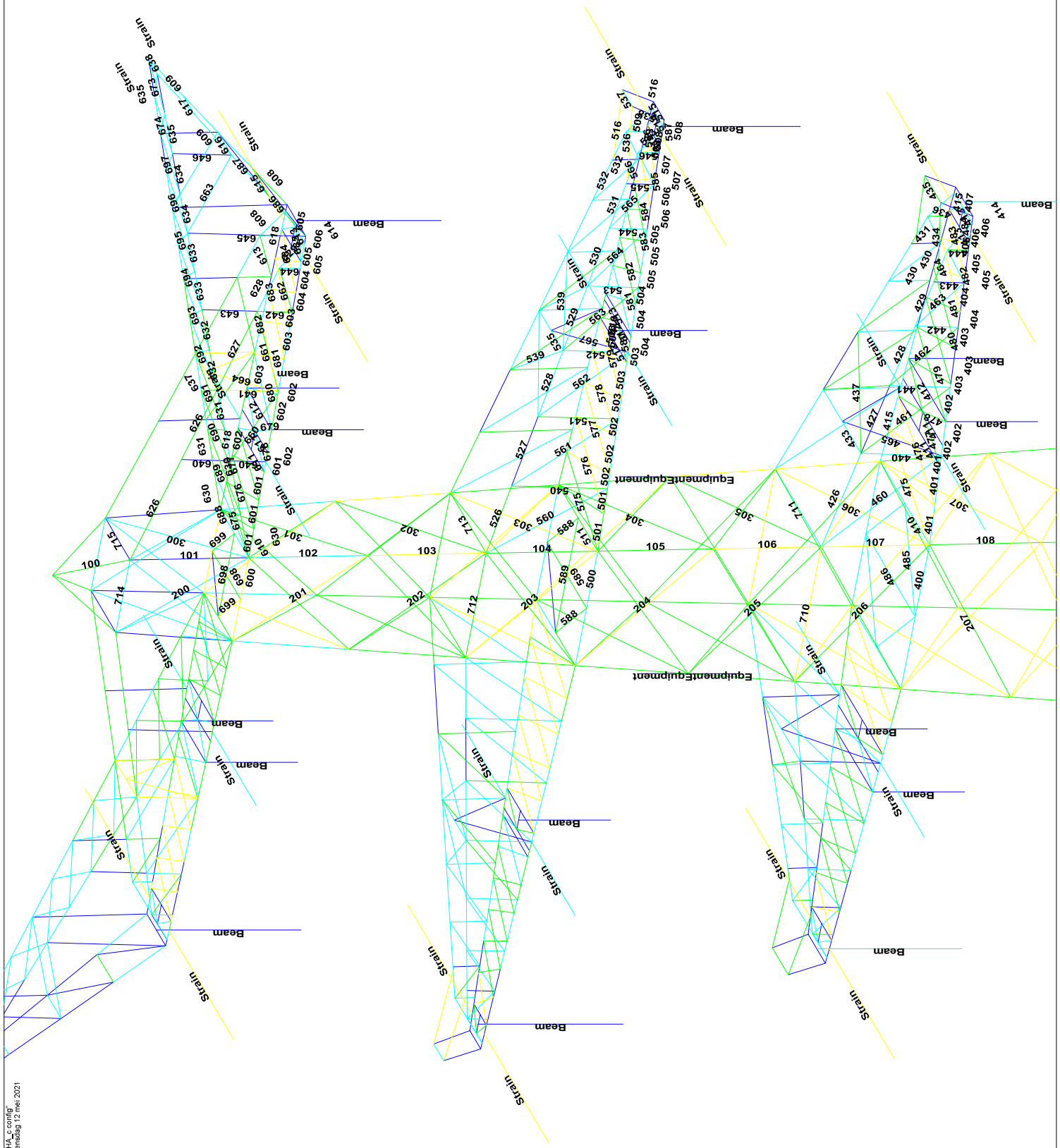



Date 15-7-2021
 Author MRE
 Version 2.0

Assessment of angle groups - Tower top

RLI-TBG
 HA4-0/C

Group Label	Element ID	Type	Grade	Area [m ²]	Dist. [m]	z-top [m]	z-btm [m]	z-avg [m]	Slenderness	Compression [kN]	Shear [kN]	U.C. (Comp)	Incidence (Comp)	Tension [kN]	U.C. (Tension)	Ret. Eccentricity [m]	U.C. (Ret)	Price [Euro]						
691	6066046	EA	6066046	5355	2016-8-8	1	35	25	0.5	0.52	0.52	0.52	0.19	64.8	120.6	141.1	70.6	0.63	60.3	120.6	108.4	120.6	108.4	0.21
692	6066046	EA	6066046	5355	1916-8-8	1	35	25	0.5	0.52	0.52	0.52	0.19	64.8	120.6	141.1	70.6	0.63	60.3	120.6	108.4	120.6	108.4	0.21
693	6066046	EA	6066046	5355	1816-8-8	1	35	25	0.5	0.52	0.52	0.52	0.19	64.8	120.6	141.1	70.6	0.63	60.3	120.6	108.4	120.6	108.4	0.21
694	6066046	EA	6066046	5355	1716-8-8	1	35	25	0.5	0.53	0.53	0.53	0.24	64.8	120.6	141.1	70.6	0.63	60.3	120.6	108.4	120.6	108.4	0.21
695	6066046	EA	6066046	5355	1616-8-8	1	35	25	0.5	0.53	0.53	0.53	0.24	64.8	120.6	141.1	70.6	0.63	60.3	120.6	108.4	120.6	108.4	0.21
696	6066046	EA	6066046	5355	1516-8-8	1	35	25	0.5	0.54	0.54	0.54	0.28	64.8	120.6	141.1	70.6	0.63	60.3	120.6	108.4	120.6	108.4	0.21
697	6066046	EA	6066046	5355	1416-8-8	1	35	25	0.5	0.54	0.54	0.54	0.28	64.8	120.6	141.1	70.6	0.63	60.3	120.6	108.4	120.6	108.4	0.21
698	1506150412	EA	1506150412	5355	4924-8-8	1	55	40	0.8	1.00	0.50	0.50	0.58	310.3	542.2	846.7	846.7	0.77	678.2	542.2	786.1	542.2	786.1	0.59
699	1406140413	EA	1406140413	5355	5924-8-8	1	55	40	0.8	1.00	1.00	1.00	0.77	678.2	542.2	846.7	846.7	0.77	678.2	542.2	786.1	542.2	786.1	0.59
700	1206120414	EA	1206120414	5355	2624-8-8	1	55	40	0.8	1.00	1.00	1.00	0.77	678.2	542.2	846.7	846.7	0.77	678.2	542.2	786.1	542.2	786.1	0.59
711	1206120412	EA	1206120412	5355	4924-8-8	1	55	40	0.8	1.00	1.00	1.00	0.77	678.2	542.2	846.7	846.7	0.77	678.2	542.2	786.1	542.2	786.1	0.59
712	1206120412	EA	1206120412	5355	4924-8-8	1	55	40	0.8	1.00	1.00	1.00	0.77	678.2	542.2	846.7	846.7	0.77	678.2	542.2	786.1	542.2	786.1	0.59
713	1206120412	EA	1206120412	5355	2624-8-8	1	55	40	0.8	1.00	1.00	1.00	0.77	678.2	542.2	846.7	846.7	0.77	678.2	542.2	786.1	542.2	786.1	0.59
714	1206120412	EA	1206120412	5355	4924-8-8	1	55	40	0.8	1.00	1.00	1.00	0.77	678.2	542.2	846.7	846.7	0.77	678.2	542.2	786.1	542.2	786.1	0.59
715	1206120412	EA	1206120412	5355	2624-8-8	1	55	40	0.8	1.00	1.00	1.00	0.77	678.2	542.2	846.7	846.7	0.77	678.2	542.2	786.1	542.2	786.1	0.59

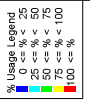
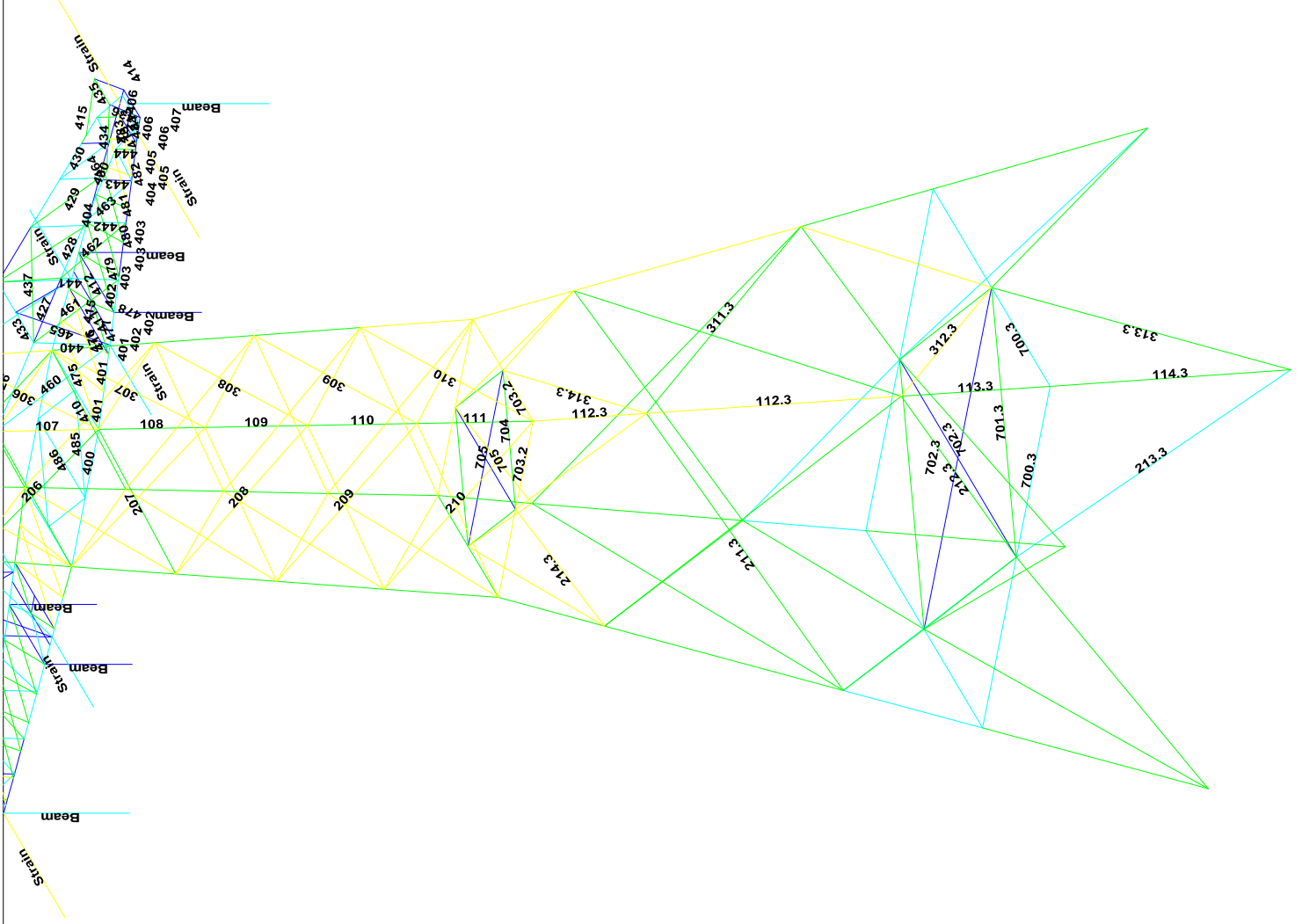



Assessment of angle groups - Lower structure

RLI_TBG
 HA46/C

Group Label	Description	Type	Profile	Steel (Q460 E, 18)	Steel (Q460 E, 18)	Slenderness	Compression	Steel Class (Compression)	Bracing	Share (Comp) (min)	U.C. (Comp) (max)	U.C. (Comp) (max) (Comp)	U.C. (Tension) (min)	U.C. (Tension) (max)	U.C. (Tension) (max) (Tens)			
108	Main leg	MEA	200x200x24	5355	2092x4-R,R	2	55	50	70	0.52	0.52	1.18	5422.1	8467.2	5511.3	5422.1	7399.3	0.62
109	Main leg	MEA	200x200x24	5355	2092x4-R,R	2	55	50	70	0.52	0.52	1.22	5422.1	8467.2	5511.3	5422.1	7399.3	0.62
110	Main leg	MEA	200x200x24	5355	2092x4-R,R	2	55	50	70	0.52	0.52	1.22	5422.1	8467.2	5511.3	5422.1	7399.3	0.62
111	Main leg	MEA	200x200x24	5355	2092x4-R,R	2	55	50	70	0.52	0.52	1.54	6448.9	10166.6	7210.5	6448.9	8711.2	0.65
207	Diag front face	DEA	120x120x12(12.6)	5355	4692x4-R,R	2	55	40	80	0.52	0.52	0.52	1084.4	1692.4	1346.9	1084.4	1578.1	0.70
208	Diag front face	DEA	120x120x12(12.6)	5355	4692x4-R,R	2	55	40	80	0.52	0.52	0.52	1084.4	1692.4	1346.9	1084.4	1578.1	0.70
209	Diag front face	DEA	120x120x12(12.6)	5355	4692x4-R,R	2	55	40	80	0.52	0.52	0.52	1084.4	1692.4	1346.9	1084.4	1578.1	0.70
210	Diag front face	DEA	120x120x12(12.6)	5355	4692x4-R,R	2	55	40	80	0.52	0.52	0.52	1084.4	1692.4	1346.9	1084.4	1578.1	0.70
307	Diag side face	DEA	120x120x12(12.6)	5355	4692x4-R,R	2	55	40	80	0.52	0.52	0.52	1084.4	1692.4	1346.9	1084.4	1578.1	0.77
308	Diag side face	DEA	120x120x12(12.6)	5355	4692x4-R,R	2	55	40	80	0.52	0.52	0.52	1084.4	1692.4	1346.9	1084.4	1578.1	0.77
309	Diag side face	DEA	120x120x12(12.6)	5355	4692x4-R,R	2	55	40	80	0.52	0.52	0.52	1084.4	1692.4	1346.9	1084.4	1578.1	0.77
310	Diag side face	DEA	120x120x12(12.6)	5355	4692x4-R,R	2	55	40	80	0.52	0.52	0.52	1084.4	1692.4	1346.9	1084.4	1578.1	0.77
705	2nd flm bearing	DEA	90x90x8 (not comp)	5355	2492x4-R,R	1	45	35	70	0.50	0.50	0.50	188.2	235.2	188.2	188.2	213.8	0.40
112.3	Main leg	MEA	200x200x24	5355	2092x4-R,R	2	55	50	70	0.50	0.50	1.68	6448.9	10166.6	4688.9	6448.9	8711.2	0.71
112.4	Main leg	MEA	200x200x24	5355	2092x4-R,R	2	55	50	70	0.50	0.50	1.68	6448.9	10166.6	4688.9	6448.9	8711.2	0.71
211.3	Diag front face	DEA	150x150x12(12.6)	5355	3624x4-R,R	2	55	40	80	0.58	0.29	0.29	698.8	1066.8	1782.0	698.8	1184.6	0.59
211.4	Diag front face	DEA	150x150x12(12.6)	5355	3624x4-R,R	2	55	40	80	0.58	0.29	0.29	698.8	1066.8	1782.0	698.8	1184.6	0.59
211.5	Diag front face	DEA	150x150x12(12.6)	5355	3624x4-R,R	2	55	40	80	0.58	0.29	0.29	698.8	1066.8	1782.0	698.8	1184.6	0.59
214.3	Diag front face	DEA	160x160x15(15.6)	5355	5024x4-R,R	2	55	40	80	0.33	1.00	0.33	1352.5	2644.0	2415.5	1352.5	2484.6	0.75
311.3	Diag side face	DEA	150x150x12(12.6)	5355	3624x4-R,R	2	55	40	80	1.00	0.50	0.50	1084.4	846.7	1782.0	1084.4	796.1	0.80
311.4	Diag side face	DEA	150x150x12(12.6)	5355	3624x4-R,R	2	55	40	80	1.00	0.50	0.50	1084.4	846.7	1782.0	1084.4	796.1	0.80
311.5	Diag side face	DEA	150x150x12(12.6)	5355	3624x4-R,R	2	55	40	80	1.00	0.50	0.50	1084.4	846.7	1782.0	1084.4	796.1	0.80
314.3	Diag side face	DEA	150x150x12(12.6)	5355	3624x4-R,R	2	55	40	80	0.33	1.00	0.33	1352.5	2644.0	2415.5	1352.5	2484.6	0.77
314.4	Diag side face	DEA	150x150x12(12.6)	5355	3624x4-R,R	2	55	40	80	1.00	0.50	0.50	1084.4	846.7	1782.0	1084.4	796.1	0.80
701.2	Hor. flm bearing hip structure	EA	110x110x10	5355	2492x4-R,R	1	45	35	70	0.50	1.00	0.50	188.2	294.0	357.3	188.2	267.3	0.44
702.2	Hor. flm bearing hip structure	EA	130x130x10 (not comp)	5355	2492x4-R,R	1	45	35	70	0.50	1.00	0.50	188.2	294.0	357.3	188.2	267.3	0.44
702.3	Hor. flm bearing hip structure	EA	130x130x10 (not comp)	5355	2492x4-R,R	1	45	35	70	0.50	1.00	0.50	188.2	294.0	357.3	188.2	267.3	0.44
702.4	2nd flm bearing	DEA	130x130x10 (not comp)	5355	2492x4-R,R	2	55	40	80	1.00	1.00	1.00	1775.4	1776.1	1511.6	1775.4	1845.6	0.81

Project: ZW-Oost
Mast: H_C

Angle check

NEN-EN1993-1-1 and EN1993-3-1

Datum: 2021-05-11
Auteur: TBR
Versie: 3.0

Member name	Group 108-109	Conclusion
Section	XEA 200x200x24	U.C. (compression) 0.72 < 1,0 OK
		U.C. (tension) 0.48 < 1,0 OK

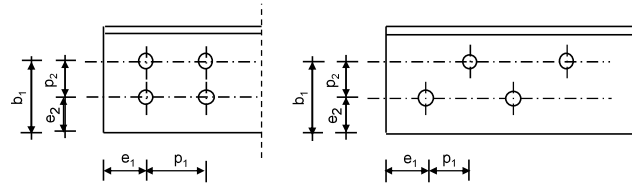
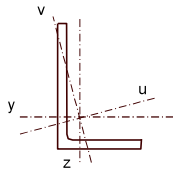

Steel grade **S355**

Member loads

Compressive force $N_{Ed} =$ **3780 kN**
Tensile force **-3352 kN**

Crossing diagonal loads

Applicable: **No**
Min. tensile force diagonal 2 **1 kN**
Max. comp. force diagonal 1 **1 kN**
Position crossing diagonal y-axis **1.00 m**

Construction loads

Vertical construction load **1.0 kN**
Member angle to horizontal **0 °**
Bending around axis **y-axis**

Geometry

System length y-axis $L_{y,buc} =$ **1.66 m**
System length z-axis $L_{z,buc} =$ **1.66 m**
System length v-axis $L_{v,buc} =$ **1.66 m**
System length x-axis $L_{tk,buc} =$ **1.66 m**
Member type **Leg**
Type bracing **Non staggered**

End conditions

Begin **Continuous**
End **Continuous**
Restraint code TOWER **C4**

Bolted connection

Bolt type **M24**
Bolt class **8.8**
Number of bolts per leg **6** (24 total)
Shearplane through **Thread**
Bolt pattern **Zigzag**
Bolt pattern (leg-member only) **Staggered**

End distance $e_1 =$ **55 mm** **Ok**
Separation distance // $p_1 =$ **70 mm** **Ok**
Separation distance | $p_2 =$ **100 mm** **Ok**
End distance $e_2 =$ **50 mm** **Ok**
Double strap or single strap **Double**
Tie plate $b_p =$ **230 mm** **OK**
 $t_p =$ **15 mm** **OK**
 $e_2 =$ **40 mm** **OK**

A **18118 mm²**
G **144.9 kg/m**
Partial safety factor $\gamma_{f;Q} =$ **1.50**
Material factors $\gamma_{M0} =$ **1.00**
 $\gamma_{M1} =$ **1.00**
 $\gamma_{M2} =$ **1.25**
Shear strength bolt $F_{v;b;Rd} =$ **135.6 kN**

Slenderness $\lambda_{max} = L / i :$ **22 -**
Allowed: **120** **OK**

Bending due to vertical construction load

$M_{y,Ed} = 1/4 F_{Ed} L_{pr} =$ **0.62 kNm**
U.C. = **0.00 < 1,00 OK**

Results stability

	$\lambda_{eff,rel}$	λ_{eff}	$\lambda_{eff,mod}$	χ_{buc}	η	$N_{b,Rd} = \eta \chi A_f \gamma / \gamma_{M1}$
$L_{y,buc} =$ 1.66 m	0.26	1,00 I	0.26	0.98	1	6299 0.60
$L_{z,buc} =$ 1.66 m	0.26	1,00 I	0.26	0.98	1	6299 0.60
$L_{v,buc} =$ 1.66 m	0.28	0,10+0,80 I	0.28	0.97	1	6237 0.61
$L_{tk,buc} =$ 1.66 m	0.55			0.81	1	5229 0.72

Bolted connection

Compression	F_{Rd} (kN)	U.C.	Tension	F_{Rd} (kN)	U.C.
Cross section angle	$F_{u;Rd} =$ 6432	0.59	Net section angle	$F_{u;Rd} =$ 6987	0.48
Cross section tie plate	$F_{u;Rd} =$ 8094	0.47	Net section tie plate	$F_{u;Rd} =$ 6943	0.48
Shear strength	$F_{v;Rd} =$ 8675	0.44	Block shear	$F_{u;Rd} =$ 10634	0.32
Bearing strength	$F_{b;Rd} =$ 11695	0.32	Shear strength	$F_{v;Rd} =$ 8675	0.39
Combined effect	$F_{v;Rd} =$ 8675	0.44	Bearing strength	$F_{b;Rd} =$ 11825	0.28
		elastisch	Combined effect	$F_{v;Rd} =$ 8675	0.39 elastisch

Project: ZW-Oost
Mast: H_C

Angle check

NEN-EN1993-1-1 and EN1993-3-1

Datum: 2021-05-10
Auteur: TBR
Versie: 3.0

Member name	Group 110-111	Conclusion
Section	XEA 250x250x24	U.C. (compression) 0.75 < 1,0 OK
		U.C. (tension) 0.61 < 1,0 OK

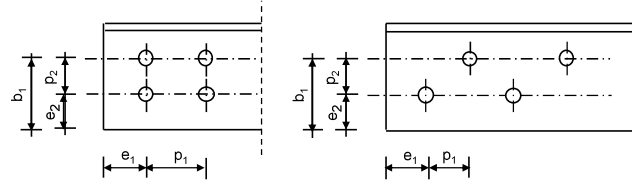
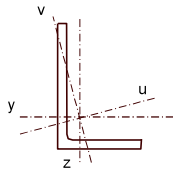

Steel grade **S355**

Member loads
Compressive force $N_{Ed} =$ **4689 kN**
Tensile force **-4222 kN**

Crossing diagonal loads
Applicable: **No**
Min. tensile force diagonal 2 **1 kN**
Max. comp. force diagonal 1 **1 kN**
Position crossing diagonal y-axis **1.00 m**

Construction loads
Vertical construction load **1.0 kN**
Member angle to horizontal **0 °**
Bending around axis **y-axis**

Geometry
System length y-axis $L_{y,buc} =$ **1.81 m**
System length z-axis $L_{z,buc} =$ **1.81 m**
System length v-axis $L_{v,buc} =$ **1.81 m**
System length x-axis $L_{tk,buc} =$ **1.81 m**
Member type **Leg**
Type bracing **Non staggered**

End conditions
Begin **Continuous**
End **Continuous**
Restraint code TOWER **C4**

Bolted connection
Bolt type **M24**
Bolt class **8.8**
Number of bolts per leg **6** (24 total)
Shearplane through **Thread**
Boltpattern **Zigzag**
Boltpattern (leg-member only) **Staggered**

End distance $e_1 =$ **55 mm** **Ok**
Separation distance // $p_1 =$ **70 mm** **Ok**
Separation distance | $p_2 =$ **100 mm** **Ok**
End distance $e_2 =$ **50 mm** **Ok**
Double strap or single strap **Double**
Tie plate $b_p =$ **230 mm** **OK**
 $t_p =$ **15 mm** **OK**
 $e_2 =$ **40 mm** **OK**

A **23036 mm²**
G **184.3 kg/m**
Partial safety factor $\gamma_{f;Q} =$ **1.50**
Material factors $\gamma_{M0} =$ **1.00**
 $\gamma_{M1} =$ **1.00**
 $\gamma_{M2} =$ **1.25**
Shear strength bolt $F_{v;b;Rd} =$ **135.6 kN**

Slenderness $\lambda_{max} = L / i :$ **19 -**
Allowed: **120 OK**

Bending due to vertical construction load
 $M_{y,Ed} = 1/4 F_{Ed} L_{pr} =$ **0.68 kNm**
U.C. = **0.00 < 1,00 OK**

Results stability

	$\lambda_{eff,rel}$	λ_{eff}	$\lambda_{eff,mod}$	χ_{buc}	η	$N_{b,Rd} = \eta \chi A_f \gamma / \gamma_{M1}$
$L_{y,buc} =$ 1.81 m	0.23	1,00 I	0.23	0.99	1	8098 0.58
$L_{z,buc} =$ 1.81 m	0.23	1,00 I	0.23	0.99	1	8098 0.58
$L_{v,buc} =$ 1.81 m	0.25	0,10+0,80 I	0.25	0.98	1	8045 0.58
$L_{tk,buc} =$ 1.81 m	0.64			0.76	1	6250 0.75

Bolted connection

	F_{Rd} (kN)	U.C.		F_{Rd} (kN)	U.C.
Compression			Tension		
Cross section angle $F_{u;Rd} =$	8178	0.57	Net section angle $F_{u;Rd} =$	6987	0.60
Cross section tie plate $F_{u;Rd} =$	8094	0.58	Net section tie plate $F_{u;Rd} =$	6943	0.61
Shear strength $F_{v;Rd} =$	8675	0.54	Block shear $F_{u;Rd} =$	10634	0.40
Bearing strength $F_{b;Rd} =$	11695	0.40	Shear strength $F_{v;Rd} =$	8675	0.49
Combined effect $F_{v;Rd} =$	8675	0.54 elastisch	Bearing strength $F_{b;Rd} =$	11825	0.36
			Combined effect $F_{v;Rd} =$	8675	0.49 elastisch

Project: ZW-Oost
Mast: H_C

Angle check

NEN-EN1993-1-1 and EN1993-3-1

Datum: 2021-05-10
Auteur: TBR
Versie: 3.0

Member name	Group 112.1-113.1-114.1	Conclusion
Section	XEA 250x250x24	U.C. (compression) 0.78 < 1,0 OK
		U.C. (tension) 0.62 < 1,0 OK

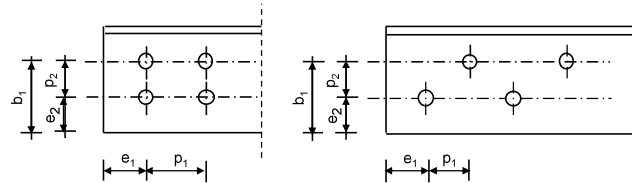
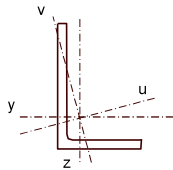

Steel grade **S355**

Member loads

Compressive force $N_{Ed} =$ **4867 kN**
Tensile force **-4327 kN**

Crossing diagonal loads

Applicable: **No**
Min. tensile force diagonal 2 **1 kN**
Max. comp. force diagonal 1 **1 kN**
Position crossing diagonal y-axis **1.00 m**

Construction loads

Vertical construction load **1.0 kN**
Member angle to horizontal **0 °**
Bending around axis **y-axis**

Geometry

System length y-axis $L_{y,buc} =$ **2.00 m**
System length z-axis $L_{z,buc} =$ **2.00 m**
System length v-axis $L_{v,buc} =$ **2.00 m**
System length x-axis $L_{tk,buc} =$ **2.00 m**
Member type **Leg**
Type bracing **Non staggered**

End conditions

Begin **Continuous**
End **Continuous**
Restraint code TOWER **C4**

Bolted connection

Bolt type **M24**
Bolt class **8.8**
Number of bolts per leg **6** (24 total)
Shearplane through **Thread**
Bolt pattern **Zigzag**
Bolt pattern (leg-member only) **Staggered**

End distance $e_1 =$ **55 mm** **Ok**
Separation distance // $p_1 =$ **70 mm** **Ok**
Separation distance | $p_2 =$ **100 mm** **Ok**
End distance $e_2 =$ **50 mm** **Ok**
Double strap or single strap **Double**
Tie plate $b_p =$ **230 mm** **OK**
 $t_p =$ **15 mm** **OK**
 $e_2 =$ **40 mm** **OK**

A **23036 mm²**
G **184.3 kg/m**
Partial safety factor $\gamma_{f;Q} =$ **1.50**
Material factors $\gamma_{M0} =$ **1.00**
 $\gamma_{M1} =$ **1.00**
 $\gamma_{M2} =$ **1.25**
Shear strength bolt $F_{v;Rd} =$ **135.6 kN**

Slenderness $\lambda_{max} = L / i :$ **21 -**
Allowed: **120** **OK**

Bending due to vertical construction load

$M_{y,Ed} = 1/4 F_{Ed} L_{pr} =$ **0.75 kNm**
U.C. = **0.00 < 1,00 OK**

Results stability

	$\lambda_{eff,rel}$	λ_{eff}	$\lambda_{eff,mod}$	χ_{buc}	η	$N_{b,Rd} = \eta \chi A_f \gamma / \gamma_{M1}$
$L_{y,buc} =$ 2.00 m	0.25	1,00 I	0.25	0.98	1	8028 0.61
$L_{z,buc} =$ 2.00 m	0.25	1,00 I	0.25	0.98	1	8028 0.61
$L_{v,buc} =$ 2.00 m	0.27	0,10+0,80 I	0.27	0.97	1	7969 0.61
$L_{tk,buc} =$ 2.00 m	0.64			0.76	1	6209 0.78

Bolted connection

Compression	F_{Rd} (kN)	U.C.	Tension	F_{Rd} (kN)	U.C.
Cross section angle	$F_{u;Rd} =$ 8178	0.60	Net section angle	$F_{u;Rd} =$ 6987	0.62
Cross section tie plate	$F_{u;Rd} =$ 8094	0.60	Net section tie plate	$F_{u;Rd} =$ 6943	0.62
Shear strength	$F_{v;Rd} =$ 8675	0.56	Block shear	$F_{u;Rd} =$ 10634	0.41
Bearing strength	$F_{b;Rd} =$ 11695	0.42	Shear strength	$F_{v;Rd} =$ 8675	0.50
Combined effect	$F_{v;Rd} =$ 8675	0.56 elastisch	Bearing strength	$F_{b;Rd} =$ 11825	0.37
			Combined effect	$F_{v;Rd} =$ 8675	0.50 elastisch

Project: ZW-Oost
Mast: H_C

Angle check

NEN-EN1993-1-1 and EN1993-3-1

Datum: 2021-05-10
Auteur: TBR
Versie: 3.0

Member name	Group 112.2-113.2-114.2	Conclusion
Section	XE A 250x250x24	U.C. (compression) 0.83 < 1,0 OK
		U.C. (tension) 0.66 < 1,0 OK

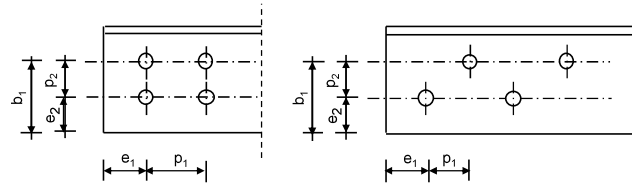
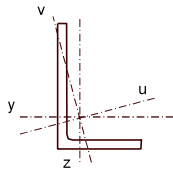

Steel grade **S355**

Member loads

Compressive force $N_{Ed} =$ **5130 kN**
Tensile force **-4595 kN**

Crossing diagonal loads

Applicable: **No**
Min. tensile force diagonal 2 **1 kN**
Max. comp. force diagonal 1 **1 kN**
Position crossing diagonal y-axis **1.00 m**

Construction loads

Vertical construction load **1.0 kN**
Member angle to horizontal **0 °**
Bending around axis **y-axis**

Geometry

System length y-axis $L_{y,buc} =$ **2.08 m**
System length z-axis $L_{z,buc} =$ **2.08 m**
System length v-axis $L_{v,buc} =$ **2.08 m**
System length x-axis $L_{tk,buc} =$ **2.08 m**
Member type **Leg**
Type bracing **Non staggered**

End conditions

Begin **Continuous**
End **Continuous**
Restraint code TOWER **C4**

Bolted connection

Bolt type **M24**
Bolt class **8.8**
Number of bolts per leg **6** (24 total)
Shearplane through **Thread**
Bolt pattern **Zigzag**
Bolt pattern (leg-member only) **Staggered**

End distance $e_1 =$ **55 mm** **Ok**
Separation distance // $p_1 =$ **70 mm** **Ok**
Separation distance | $p_2 =$ **100 mm** **Ok**
End distance $e_2 =$ **50 mm** **Ok**
Double strap or single strap **Double**
Tie plate $b_p =$ **230 mm** **OK**
 $t_p =$ **15 mm** **OK**
 $e_2 =$ **40 mm** **OK**

A **23036 mm²**
G **184.3 kg/m**
Partial safety factor $\gamma_{F;Q} =$ **1.50**
Material factors $\gamma_{M0} =$ **1.00**
 $\gamma_{M1} =$ **1.00**
 $\gamma_{M2} =$ **1.25**
Shear strength bolt $F_{v;b;Rd} =$ **135.6 kN**

Slenderness $\lambda_{max} = L / i :$ **22 -**
Allowed: **120 OK**

Bending due to vertical construction load

$M_{y,Ed} = 1/4 F_{Ed} L_{pr} =$ **0.78 kNm**
U.C. = **0.00 < 1,00 OK**

Results stability

	$\lambda_{eff,rel}$	λ_{eff}	$\lambda_{eff,mod}$	χ_{buc}	η	$N_{b,Rd} = \eta \chi A_f \gamma / \gamma_{M1}$
$L_{y,buc} =$ 2.08 m	0.26	1,00 I	0.26	0.98	1	7998 0.64
$L_{z,buc} =$ 2.08 m	0.26	1,00 I	0.26	0.98	1	7998 0.64
$L_{v,buc} =$ 2.08 m	0.28	0,10+0,80 I	0.28	0.97	1	7937 0.65
$L_{tk,buc} =$ 2.08 m	0.65			0.76	1	6194 0.83

Bolted connection

Compression	F_{Rd} (kN)	U.C.	Tension	F_{Rd} (kN)	U.C.
Cross section angle	$F_{u;Rd} =$ 8178	0.63	Net section angle	$F_{u;Rd} =$ 6987	0.66
Cross section tie plate	$F_{u;Rd} =$ 8094	0.63	Net section tie plate	$F_{u;Rd} =$ 6943	0.66
Shear strength	$F_{v;Rd} =$ 8675	0.59	Block shear	$F_{u;Rd} =$ 10634	0.43
Bearing strength	$F_{b;Rd} =$ 11695	0.44	Shear strength	$F_{v;Rd} =$ 8675	0.53
Combined effect	$F_{v;Rd} =$ 8675	0.59 elastisch	Bearing strength	$F_{b;Rd} =$ 11825	0.39
			Combined effect	$F_{v;Rd} =$ 8675	0.53 elastisch

Project: ZW-Oost
Mast: H_C

Angle check

NEN-EN1993-1-1 and EN1993-3-1

Datum: 2021-05-10
Auteur: TBR
Versie: 3.0

Member name	Group 112.3-113.3-114.3	Conclusion
Section	XEA 250x250x24	U.C. (compression) 0.84 < 1,0 OK
		U.C. (tension) 0.66 < 1,0 OK

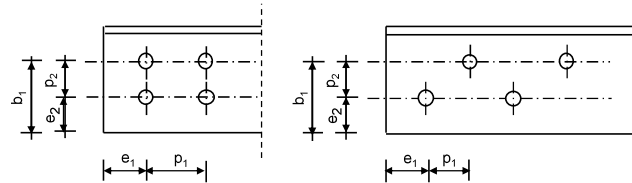
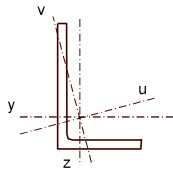

Steel grade **S355**

Member loads

Compressive force $N_{Ed} =$ **5156 kN**
Tensile force **-4605 kN**

Crossing diagonal loads

Applicable: **No**
Min. tensile force diagonal 2 **1 kN**
Max. comp. force diagonal 1 **1 kN**
Position crossing diagonal y-axis **1.00 m**

Construction loads

Vertical construction load **1.0 kN**
Member angle to horizontal **0 °**
Bending around axis **y-axis**

Geometry

System length y-axis $L_{y,buc} =$ **2.34 m**
System length z-axis $L_{z,buc} =$ **2.34 m**
System length v-axis $L_{v,buc} =$ **2.34 m**
System length x-axis $L_{tk,buc} =$ **2.34 m**
Member type **Leg**
Type bracing **Non staggered**

End conditions

Begin **Continuous**
End **Continuous**
Restraint code TOWER **C4**

Bolted connection

Bolt type **M24**
Bolt class **8.8**
Number of bolts per leg **6** (24 total)
Shearplane through **Thread**
Bolt pattern **Zigzag**
Bolt pattern (leg-member only) **Staggered**

End distance $e_1 =$ **55 mm** **Ok**
Separation distance // $p_1 =$ **70 mm** **Ok**
Separation distance | $p_2 =$ **100 mm** **Ok**
End distance $e_2 =$ **50 mm** **Ok**
Double strap or single strap **Double**
Tie plate $b_p =$ **230 mm** **OK**
 $t_p =$ **15 mm** **OK**
 $e_2 =$ **40 mm** **OK**

A **23036 mm²**
G **184.3 kg/m**
Partial safety factor $\gamma_{F;Q} =$ **1.50**
Material factors $\gamma_{M0} =$ **1.00**
 $\gamma_{M1} =$ **1.00**
 $\gamma_{M2} =$ **1.25**
Shear strength bolt $F_{v;Rd} =$ **135.6 kN**

Slenderness $\lambda_{max} = L / i :$ **24 -**
Allowed: **120** **OK**

Bending due to vertical construction load

$M_{y,Ed} = 1/4 F_{Ed} L_{pr} =$ **0.88 kNm**
U.C. = **0.00 < 1,00 OK**

Results stability

	$\lambda_{eff,rel}$	λ_{eff}	$\lambda_{eff,mod}$	χ_{buc}	η	$N_{b,Rd} = \eta \chi A_f \gamma / \gamma_{M1}$
$L_{y,buc} =$ 2.34 m	0.29	1,00 I	0.29	0.97	1	7902 0.65
$L_{z,buc} =$ 2.34 m	0.29	1,00 I	0.29	0.97	1	7902 0.65
$L_{v,buc} =$ 2.34 m	0.32	0,10+0,80 I	0.32	0.96	1	7831 0.66
$L_{tk,buc} =$ 2.34 m	0.65			0.75	1	6155 0.84

Bolted connection

Compression	F_{Rd} (kN)	U.C.	Tension	F_{Rd} (kN)	U.C.
Cross section angle $F_{u;Rd} =$	8178	0.63	Net section angle $F_{u;Rd} =$	6987	0.66
Cross section tie plate $F_{u;Rd} =$	8094	0.64	Net section tie plate $F_{u;Rd} =$	6943	0.66
Shear strength $F_{v;Rd} =$	8675	0.59	Block shear $F_{u;Rd} =$	10634	0.43
Bearing strength $F_{b;Rd} =$	11695	0.44	Shear strength $F_{v;Rd} =$	8675	0.53
Combined effect $F_{v;Rd} =$	8675	0.59 elastisch	Bearing strength $F_{b;Rd} =$	11825	0.39
			Combined effect $F_{v;Rd} =$	8675	0.53 elastisch

Project: ZW-oost
Mast: HC+0

Angle check

NEN-EN1993-1-1 and EN1993-3-1

Datum: 2021-05-17
Auteur: TBR
Versie: 2,9

Member name	Group 310	Conclusion
Section	vDEA 120x120x12 (20)	U.C. (compression) 0,87 < 1,0 OK
		U.C. (tension) 0,42 < 1,0 OK

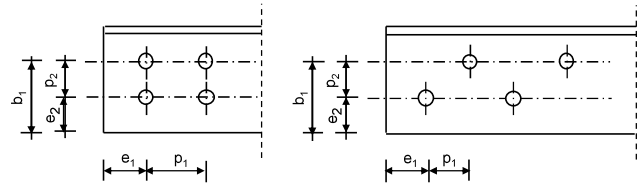
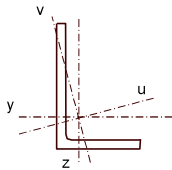

Steel grade **S355**

Member loads

Compressive force $N_{Ed} =$ **690 kN**
Tensile force **-690 kN**

Aanvullende knikcontrole o.b.v. "standaard" EC-knikcontrole met knikkromme "c" voor staven met twee hoekprofielen

$N_{b,Rd,PLS} = 855\text{kN}$
 $N_{b,Rd,EC} = 798\text{kN}$

Crossing diagonal loads

Applicable: **No**
Min. tensile force diagonal 2 **1 kN**
Max. comp. force diagonal 1 **1 kN**
Position crossing diagonal y-axis **1,00 m**

Construction loads

Vertical construction load **1,0 kN**
Member angle to horizontal **0 °**
Bending around axis **y-axis**

Geometry

System length y-axis $L_{y,buc} =$ **3,50 m**
System length z-axis $L_{z,buc} =$ **3,50 m**
System length v-axis $L_{v,buc} =$ **3,50 m**

Member type **Other**
Type bracing **Non staggered**

End conditions

Begin **Continuous**
End **Continuous**
Restraint code TOWER **C4**

Results stability

		$\lambda_{eff,rel}$	λ_{eff}	χ_{buc}	η	$N_{b,Rd} = \eta \chi A f_y / \gamma_{M1}$	
$L_{y,buc} =$	3,50 m	1,25	1,25	0,41	1	798	0,87
$L_{z,buc} =$	3,50 m	1,07	1,07	0,50	1	982	0,70
$L_{v,buc} =$	3,50 m	1,24	1,24	0,41	1	810	0,85
$L_{tk,buc} =$	3,50 m	0,80		0,66	1	1292	0,53

Project: ZW-oost
Mast: HC+0

Angle check

NEN-EN1993-1-1 and EN1993-3-1

Datum: 2021-05-17
Auteur: TBR
Versie: 2,9

Member name	Group 311.3	Conclusion
Section	vDEA 150x150x12 (12)	U.C. (compression) 0,73 < 1,0 OK
		U.C. (tension) 0,31 < 1,0 OK

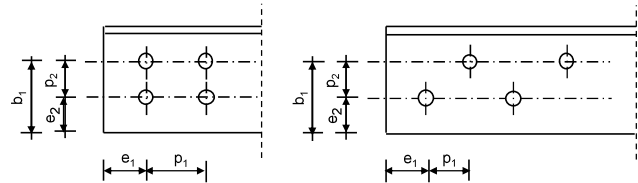
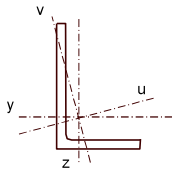

Steel grade **S355**

Member loads

Compressive force $N_{Ed} =$ **510 kN**
Tensile force **-510 kN**

Crossing diagonal loads

Applicable: **No**
Min. tensile force diagonal 2 **1 kN**
Max. comp. force diagonal 1 **1 kN**
Position crossing diagonal y-axis **1,00 m**

Construction loads

Vertical construction load **1,0 kN**
Member angle to horizontal **0 °**
Bending around axis **y-axis**

Geometry

System length y-axis $L_{y,buc} =$ **3,25 m**
System length z-axis $L_{z,buc} =$ **6,51 m**
System length v-axis $L_{v,buc} =$ **3,25 m**

Member type **Other**
Type bracing **Non staggered**

End conditions

Begin **Continuous**
End **Continuous**
Restraint code TOWER **C4**

Aanvullende knikcontrole o.b.v. "standaard" EC-knikcontrole met knikkromme "c" voor staven met twee hoekprofielen

$N_{b,Rd,PLS} = 822\text{kN}$
 $N_{b,Rd,EC} = 696\text{kN}$

Results stability

		$\lambda_{eff,rel}$	λ_{eff}	$\lambda_{eff,mod}$	χ_{buc}	η	$N_{b,Rd} = \eta \chi A f_y / \gamma_{M1}$	
$L_{y,buc} =$	3,25 m	0,92	0,92	1,05	0,58	1	1447	0,35
$L_{z,buc} =$	6,51 m	1,61	1,61	1,53	0,28	1	696	0,73
$L_{v,buc} =$	3,25 m	0,92	0,92	0,99	0,59	1	1459	0,35
$L_{tk,buc} =$	3,25 m	0,77			0,68	1	1684	0,30

Project: ZW-oost
Mast: HC+0

Angle check

NEN-EN1993-1-1 and EN1993-3-1

Datum: 2021-05-17
Auteur: TBR
Versie: 2,9

Member name	Group 213.3	Conclusion
Section	vDEA 160x160x15 (24)	U.C. (compression) 0,81 < 1,0 OK
		U.C. (tension) 0,25 < 1,0 OK

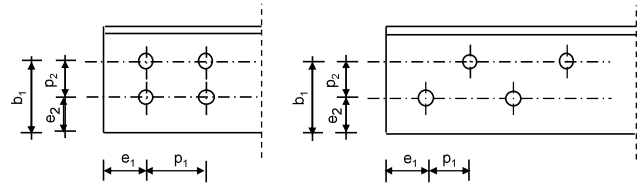
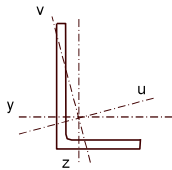

Steel grade **S355**

Member loads

Compressive force $N_{Ed} =$ **420 kN**
Tensile force **-420 kN**

Crossing diagonal loads

Applicable: **No**
Min. tensile force diagonal 2 **1 kN**
Max. comp. force diagonal 1 **1 kN**
Position crossing diagonal y-axis **1,00 m**

Construction loads

Vertical construction load **1,0 kN**
Member angle to horizontal **0 °**
Bending around axis **y-axis**

Geometry

System length y-axis $L_{y,buc} =$ **3,30 m**
System length z-axis $L_{z,buc} =$ **9,90 m**
System length v-axis $L_{v,buc} =$ **3,30 m**

Aanvullende knikcontrole o.b.v. "standaard" EC-knikcontrole met knikkromme "c" voor staven met twee hoekprofielen

$N_{b,Rd,PLS} = 704\text{kN}$
 $N_{b,Rd,EC} = 520\text{kN}$

Results stability

		$\lambda_{eff,rel}$	λ_{eff}	χ_{buc}	η	$N_{b,Rd} = \eta \chi A f_y / \gamma_{M1}$	
$L_{y,buc} =$	3,30 m	0,88	0,88	0,61	1	2031	0,21
$L_{z,buc} =$	9,90 m	2,27	2,27	0,16	1	520	0,81
$L_{v,buc} =$	3,30 m	0,89	0,89	0,61	1	2010	0,21
$L_{tk,buc} =$	3,30 m	0,66		0,75	1	2484	0,17

APPENDIX C

Knikverkorters

Niet in PLS-TOWER gemodelleerde elementen in de constructie worden aanvullend getoetst. Hieronder vallen de knikverkorters van de randstijl en profielen onderdeel van stabiliteitsverbanden. De staven worden getoetst op:

- voldoende trek- of druksterkte als steungevend profiel voor randstijl, 1% van de knikcapaciteit van de randstijl;
- slankheid;
- klimbelasting

Voor de beloopbaarheid zijn staven in de traverse aanwezig. Deze zijn niet constructief (voorzien van slobgaten) en worden enkel getoetst op de klimbelasting van 1,0 kN. Zie hoofdstuk 4.2.5 en 5.7.2. van het uitgangspuntenrapport.

De knikverkorters van het bovenstuk zijn voor alle masttypen in de groep van combi-hoekmasten gelijk. Om deze reden worden alléén voor masttype HA+0/c de knikverkorters van het bovenstuk en het onderstuk getoetst. Voor de overige masttypen worden alleen de knikverkorters van het onderstuk getoetst.

Profielen uit horizontaalverbanden van het onderstuk zijn in PLS-TOWER aanwezig maar worden in deze Appendix aanvullend getoetst op buiging. Profielafmeting en boutverbinding uit PLS-TOWER is leidend.

Overzicht knikverkorters – HA+0/c

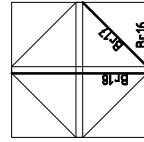
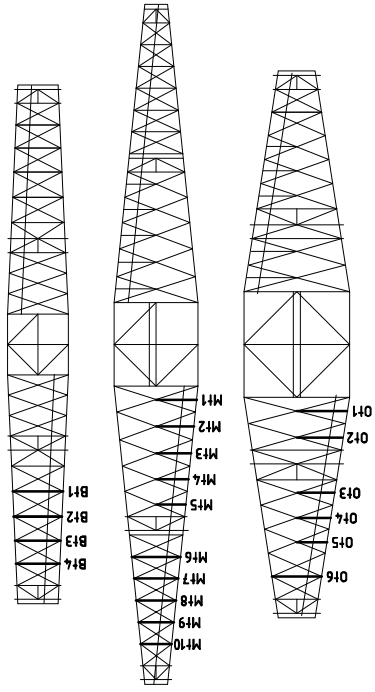

Tussenschot +15,9m

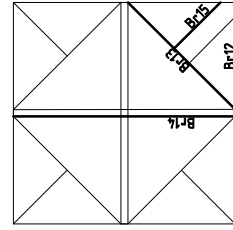

Tussenschot +6,04m

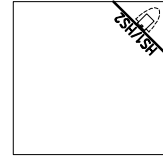

Standaard frame

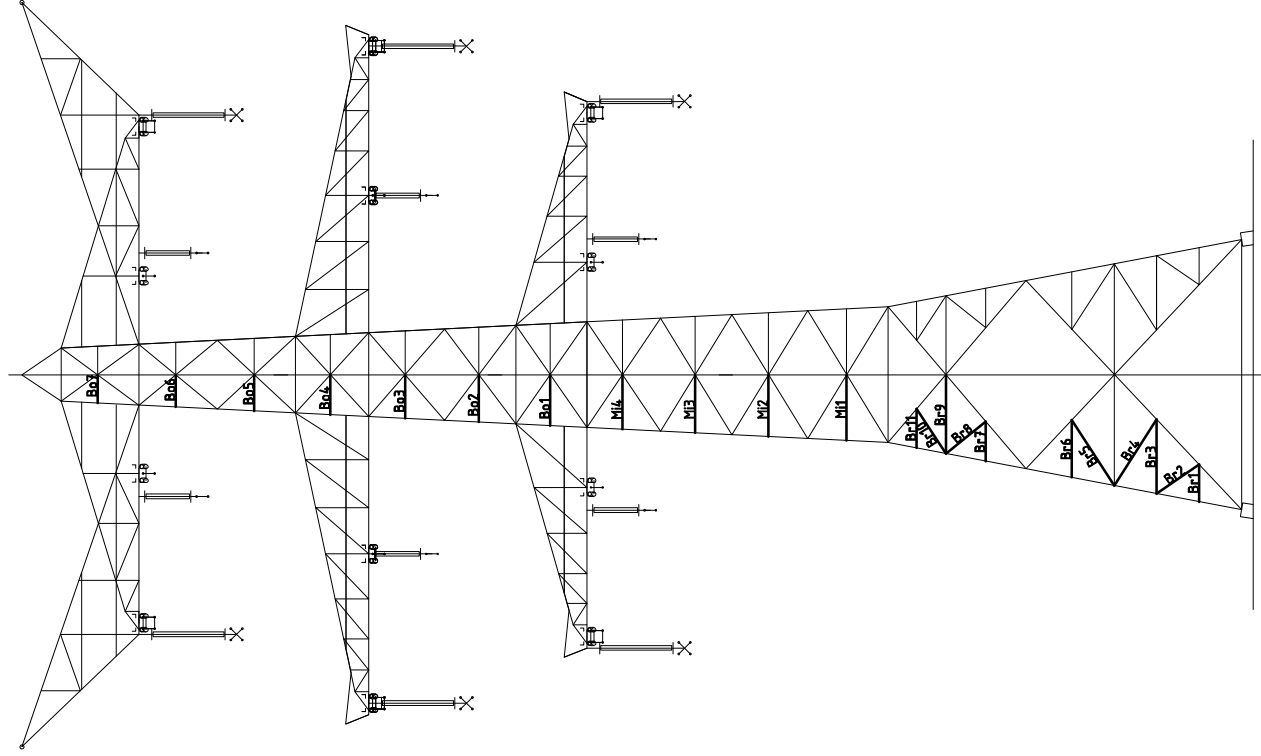



Redundant members

RLL-TLB
HA+0/c

Date: 2021-07-09
Author: MRE
Version: 1.9

Posnr.	Section	Schematization	Profile	Steel Quality	Bolt	Quality	Length (m)	Angle (°)	Slender ness	Normal Force (kN)	Moment (kNm)	Buckling Cap. (kN)	Shear Cap. Bolt (kN)	Bearing Cap. (kN)	Net Section Cap. (kN)	Moment Cap. (kNm)	Highest U.C.	Max. usage	Notes
B3	Boventraverse	Enkele staaf	L50x5	S355/0	M16	8.8	2.00	0	205	0.0	0.75	23.4	60.3	41.3	43.1	0.8	0.96	Bending	
B4	Boventraverse	Enkele staaf	L50x5	S355/0	M16	8.8	1.91	0	196	0.0	0.72	25.1	60.3	41.3	43.1	0.8	0.93	Bending	
HS1	High Step	Enkele staaf	L80x6	S355/0	M16	8.8	3.25	0	207	0.0	2.44	45.2	60.3	52.3	145.8	2.7	0.95	Bending	
HS2	High Step	Enkele staaf	L70x7	S355/0	M16	8.8	2.80	0	205	0.0	2.10	46.0	60.3	61.0	142.7	2.2	0.97	Bending	

Overzicht knikverkorters – HA+3/c

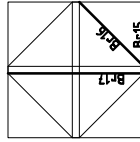
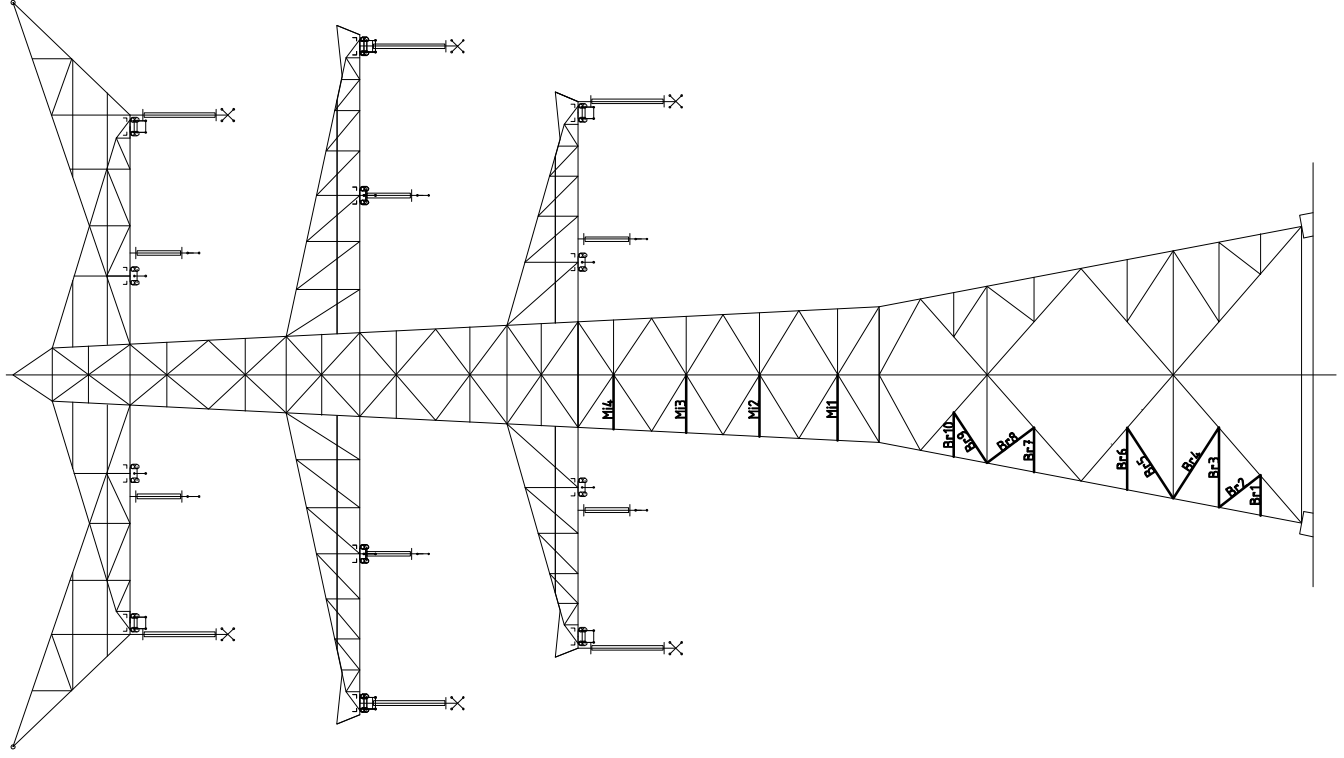

Tussenschot +18,9m

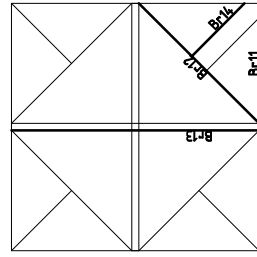

Tussenschot +6,09m



Redundant members

Date: 2021-07-09
 Author: MRE
 Version: 1.9

RLI-TLB
 HA+3/c

Posnr.	Section	Schematization	Profile	Steel Quality	Bolt Quality	Length (m)	Angle (°)	Slenderness	Normal Force (kN)	Moment (kNm)	Buckling Cap. (kN)	Shear Cap. Bolt (kN)	Bearing Cap. (kN)	Net Section Cap. (kN)	Moment Cap. (kNm)	Highest U.C.	Max. usage	Notes
Br1	Broekstuk	Enkele staaf	L70x6	S355J0	M20	8.8	1.76	0	61.9	0.66	76.9	94.1	71.3	112.9	1.99	0.87	Bearing	
Br2	Broekstuk	Enkele staaf	L80x6	S355J0	M20	8.8	2.28	52	145	1.30	75.5	94.1	71.3	136.4	2.68	0.87	Bearing	
Br3	Broekstuk	Enkele staaf	L90x8	S355J0	M20	8.8	3.47	0	197	1.30	72.3	94.1	95.0	213.2	4.34	0.86	Buckling	
Br4	Broekstuk	Enkele staaf	L90x8	S355J0	M20	8.8	3.68	30	209	1.20	66.1	94.1	95.0	213.2	4.34	0.94	Buckling	
Br5	Broekstuk	Enkele staaf	L90x8	S355J0	M20	8.8	3.67	30	208	1.19	66.4	94.1	95.0	213.2	4.34	0.93	Buckling	
Br6	Broekstuk	Enkele staaf	L80x6	S355J0	M20	8.8	2.70	0	173	1.01	77.4	94.1	95.0	181.9	3.33	0.80	Buckling	
Br7	Broekstuk	Enkele staaf	L70x6	S355J0	M20	8.8	1.93	0	141	0.72	68.3	94.1	71.3	112.9	1.99	0.91	Buckling	
Br8	Broekstuk	Enkele staaf	L80x6	S355J0	M20	8.8	2.56	53	163	0.72	64.3	94.1	71.3	136.4	2.68	0.96	Buckling	
Br9	Broekstuk	Enkele staaf	L80x6	S355J0	M20	8.8	2.64	30	169	0.86	80.0	94.1	95.0	181.9	3.33	0.77	Buckling	
Br10	Broekstuk	Enkele staaf	L70x6	S355J0	M20	8.8	1.93	0	141	0.72	68.3	94.1	71.3	112.9	1.99	0.91	Buckling	
Br11	Tussenschot +6,09m	Enkele staaf	L110x10	S355J0	M20	8.8	5.39	0	250	2.02	75.9	94.1	118.8	345.0	8.04	0.26	Bending	
Br12	Tussenschot +6,09m	Kniksteun op 0,5L	L100x8	S355J0	M16	8.8	7.41	0	241	0.0	50.3	60.3	69.7	257.2	7.19	0.39	Bending	
Br13	Tussenschot +6,09m	Kruisende staaf halverwege	L110x10	S355J0	M16	8.8	10.78	0	250	2.02	75.9	60.3	87.1	360.6	10.69	0.19	Bending	
Br14	Tussenschot +6,09m	Enkele staaf	L80x6	S355J0	M16	8.8	3.70	0	235	0.0	36.9	60.3	52.3	145.8	2.68	0.54	Bending	
Br15	Tussenschot +18,9m	Kniksteun op 0,5L	L130x12	S355J0	M20	8.8	2.95	0	74	1.11	379.8	94.1	142.5	602.1	17.91	0.06	Bending	
Br16	Tussenschot +18,9m	Enkele staaf	L90x8	S355J0	M16	8.8	3.97	0	225	0.0	58.8	60.3	69.7	225.8	4.34	0.36	Bending	
Br17	Tussenschot +18,9m	Kruisende staaf halverwege	L90x8	S355J0	M16	8.8	5.91	0	168	1.11	91.6	60.3	69.7	225.8	5.70	0.19	Bending	
M11	Middenstuk1	Enkele staaf	L80x8	S355J0	M20	8.8	2.87	0	184	1.07	71.0	94.1	95.0	181.9	3.33	0.88	Buckling	
M12	Middenstuk2	Enkele staaf	L80x8	S355J0	M20	8.8	2.70	0	173	1.01	77.6	94.1	95.0	181.9	3.33	0.80	Buckling	
M13	Middenstuk2	Enkele staaf	L80x6	S355J0	M20	8.8	2.53	0	161	0.95	65.3	94.1	71.3	136.4	2.68	0.80	Buckling	
M14	Middenstuk2	Enkele staaf	L80x6	S355J0	M20	8.8	2.38	0	151	0.89	71.4	94.1	71.3	136.4	2.68	0.73	Bearing	

Overzicht knikverkorters – HA+6/c

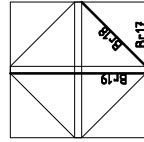
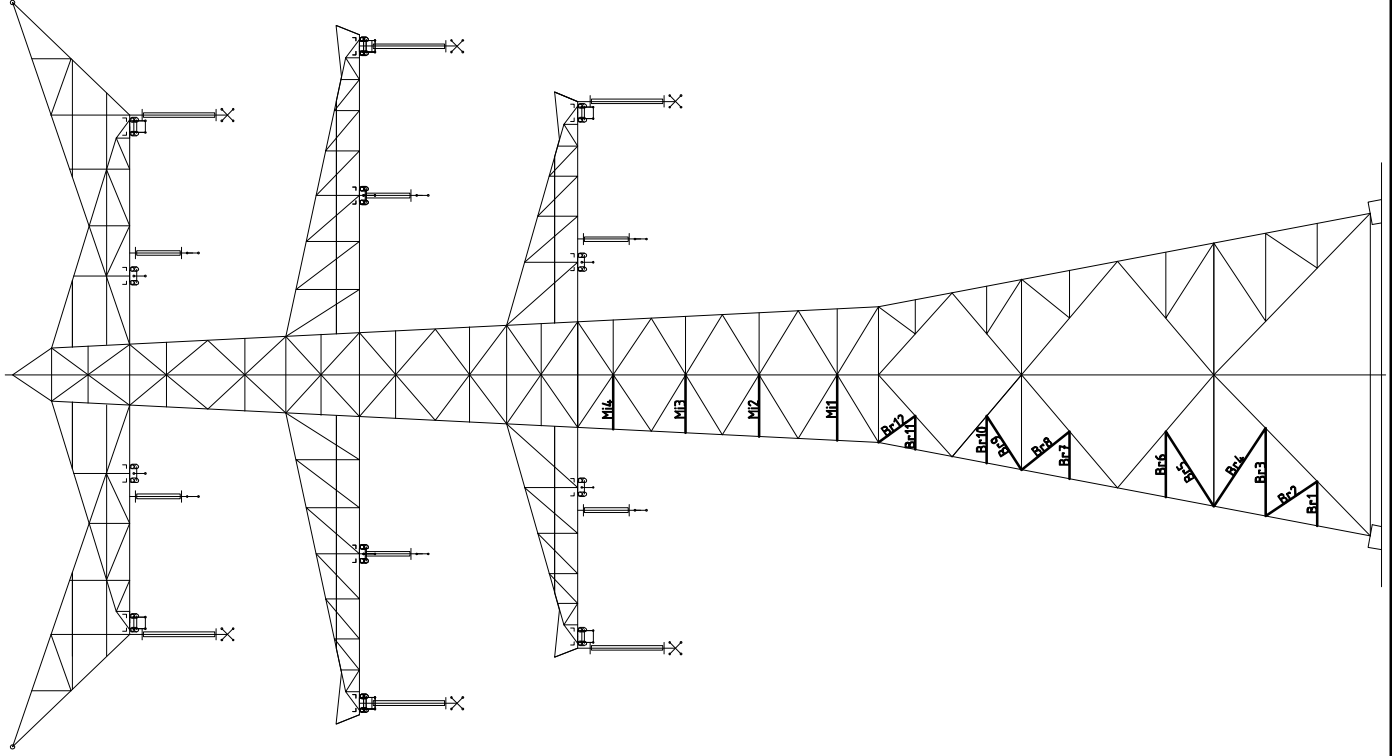

Tussenschot +21,9m

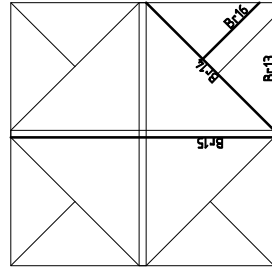

Tussenschot +7,3m



Redundant members

RLL-TLB
HA+6/c

Date: 2021-07-09
Author: MRE
Version: 1.9

Posnr.	Section	Schematization	Profile	Steel Quality	Bolt Quality	Length (m)	Angle (°)	Slenderness	Normal Force (kN)	Moment (kNm)	Buckling Cap. (kN)	Shear Cap. Bolt (kN)	Bearing Cap. (kN)	Net Section Cap. (kN)	Moment Cap. (kNm)	Highest U.C.	Max. usage	Notes
Br1	Broekstuk	Enkele staaf	L70x6	S355J0	M20	8.8	1.94	0	141	61.5	0.73	67.8	94.1	71.3	112.9	1.99	0.91	Buckling
Br2	Broekstuk	Enkele staaf	L80x8	S355J0	M20	8.8	2.71	56	174	61.5	0.00	77.0	94.1	95.0	181.9	3.33	0.80	Buckling
Br3	Broekstuk	Enkele staaf	L90x9	S355J0	M20	8.8	3.83	0	218	1.44	1.44	69.0	94.1	106.9	239.9	4.73	0.89	Buckling
Br4	Broekstuk	Enkele staaf	L100x10	S355J0	M20	8.8	4.08	30	209	61.5	1.33	91.4	94.1	118.8	305.8	6.49	0.67	Buckling
Br5	Broekstuk	Enkele staaf	L90x9	S355J0	M20	8.8	3.88	30	221	61.5	1.26	67.6	94.1	106.9	239.9	4.73	0.91	Buckling
Br6	Broekstuk	Enkele staaf	L80x8	S355J0	M20	8.8	2.86	0	183	61.5	1.07	71.2	94.1	95.0	181.9	3.33	0.86	Buckling
Br7	Broekstuk	Enkele staaf	L80x6	S355J0	M20	8.8	2.07	0	132	61.5	0.78	85.6	94.1	71.3	136.4	2.68	0.86	Bearing
Br8	Broekstuk	Enkele staaf	L80x6	S355J0	M20	8.8	2.68	51	172	61.5	0.00	78.3	94.1	95.0	181.9	3.33	0.79	Buckling
Br9	Broekstuk	Enkele staaf	L80x8	S355J0	M20	8.8	2.80	30	180	61.5	0.91	73.4	94.1	83.2	181.9	3.33	0.84	Buckling
Br10	Broekstuk	Enkele staaf	L70x7	S355J0	M20	8.8	2.07	0	152	61.5	0.78	71.3	94.1	95.0	131.7	2.23	0.86	Buckling
Br11	Broekstuk	Enkele staaf	L60x6	S355J0	M20	8.8	1.48	0	127	61.5	0.56	66.4	94.1	64.7	65.9	1.40	0.94	Bearing
Br12	Broekstuk	Enkele staaf	L70x6	S355J0	M20	8.8	1.98	54	144	61.5	0.00	66.0	94.1	71.3	112.9	1.99	0.93	Buckling
Br13	Tussenschot + 7,3m	Enkele staaf	L120x10	S355J0	M16	8.8	5.73	0	241	0.0	2.15	88.1	60.3	87.1	395.8	9.77	0.23	Bending
Br14	Tussenschot + 7,3m	Kniksteun op 0,5l	L110x10	S355J0	M16	8.8	7.89	0	235	0.0	2.96	71.2	60.3	87.1	360.6	10.69	0.28	Bending
Br15	Tussenschot + 7,3m	Kruisende staaf halverwege	L120x10	S355J0	M16	8.8	11.46	0	241	0.0	2.15	88.1	60.3	87.1	395.8	12.83	0.17	Bending
Br16	Tussenschot + 7,3m	Enkele staaf	L90x8	S355J0	M16	8.8	3.94	0	224	0.0	1.48	59.5	60.3	69.7	225.8	4.34	0.35	Bending
Br17	Tussenschot + 21,9m	Kniksteun op 0,5l	L130x12	S355J0	M20	8.8	2.96	0	75	0.0	1.11	378.8	94.1	142.5	602.1	17.91	0.06	Bending
Br18	Tussenschot + 21,9m	Enkele staaf	L90x8	S355J0	M16	8.8	3.97	0	225	0.0	1.49	58.8	60.3	69.7	225.8	4.34	0.36	Bending
Br19	Tussenschot + 21,9m	Kruisende staaf halverwege	L90x8	S355J0	M16	8.8	5.91	0	168	0.0	1.11	91.6	60.3	69.7	225.8	5.70	0.19	Bending
M1	Middenstuk1	Enkele staaf	L80x8	S355J0	M20	8.8	2.87	0	184	62.5	1.07	71.0	94.1	95.0	181.9	3.33	0.88	Buckling
M2	Middenstuk1	Enkele staaf	L80x8	S355J0	M20	8.8	2.70	0	173	62.5	1.01	77.6	94.1	95.0	181.9	3.33	0.80	Buckling
M3	Middenstuk2	Enkele staaf	L80x6	S355J0	M20	8.8	2.53	0	161	52.2	0.95	65.3	94.1	71.3	136.4	2.68	0.80	Buckling
M4	Middenstuk2	Enkele staaf	L80x6	S355J0	M20	8.8	2.38	0	151	52.2	0.89	71.4	94.1	71.3	136.4	2.68	0.73	Bearing



APPENDIX D

Blokdeuvels



Het uitgangspunt voor de berekening van de ingestorte rand met blokdeuvels zijn de belastingen op de fundatie uit de uitvoer van het geleiderbelastingprogramma van DNV. De belastingen in de richting van de randstijl zijn van toepassing. In de tabellen is dit opgenomen in de laatste kolom $R_{z,lok}$. De controles zijn uitgevoerd met een spreadsheet. Vanwege de helling van de drukdiagonaal wordt per krachtrichting bepaald hoeveel deuvels effectief zijn, hierdoor is het aantal ingevoerde deuvels in de berekening kleiner dan het aantal deuvels op de principetekening.

Er wordt voor gekozen om de blokdeuvels universeel uit te werken op basis van het profiel van de randstijl, dit betreft een XEA250x250x24-profiel en heeft betrekking op de volgende masttypen:

- Masttype HA+0/c, HA+0/ci, HA+3/c, HA+3/ca en HA+6/c;
- Masttype HB+0/c en HB+6/c;
- Masttype HC+0/c;
- Masttype WA+0/c en WA+6/c;
- Masttype WB+0/c;
- Masttype EA-3/co.

De blokdeuvels worden getoetst op de maatgevende belasting van bovenstaande masttypen. De belasting is opgenomen in Appendix A van het betreffende masttype, masttype HC+0/c is maatgevend. De optredende belastingen van masttype HC+0/c zijn 5503kN (druk) en -4739kN (trek), deze worden ruim naar boven afgerond op **5600kN** (druk) en **-4800kN** (trek). Met deze belastingen worden alle masttypen geborgd en hebben eventuele kleine aanpassingen geen invloed op deze uitwerking.

Principe blokdeuvels - combi-hoek-, combi-wissel en combi-eindmasten

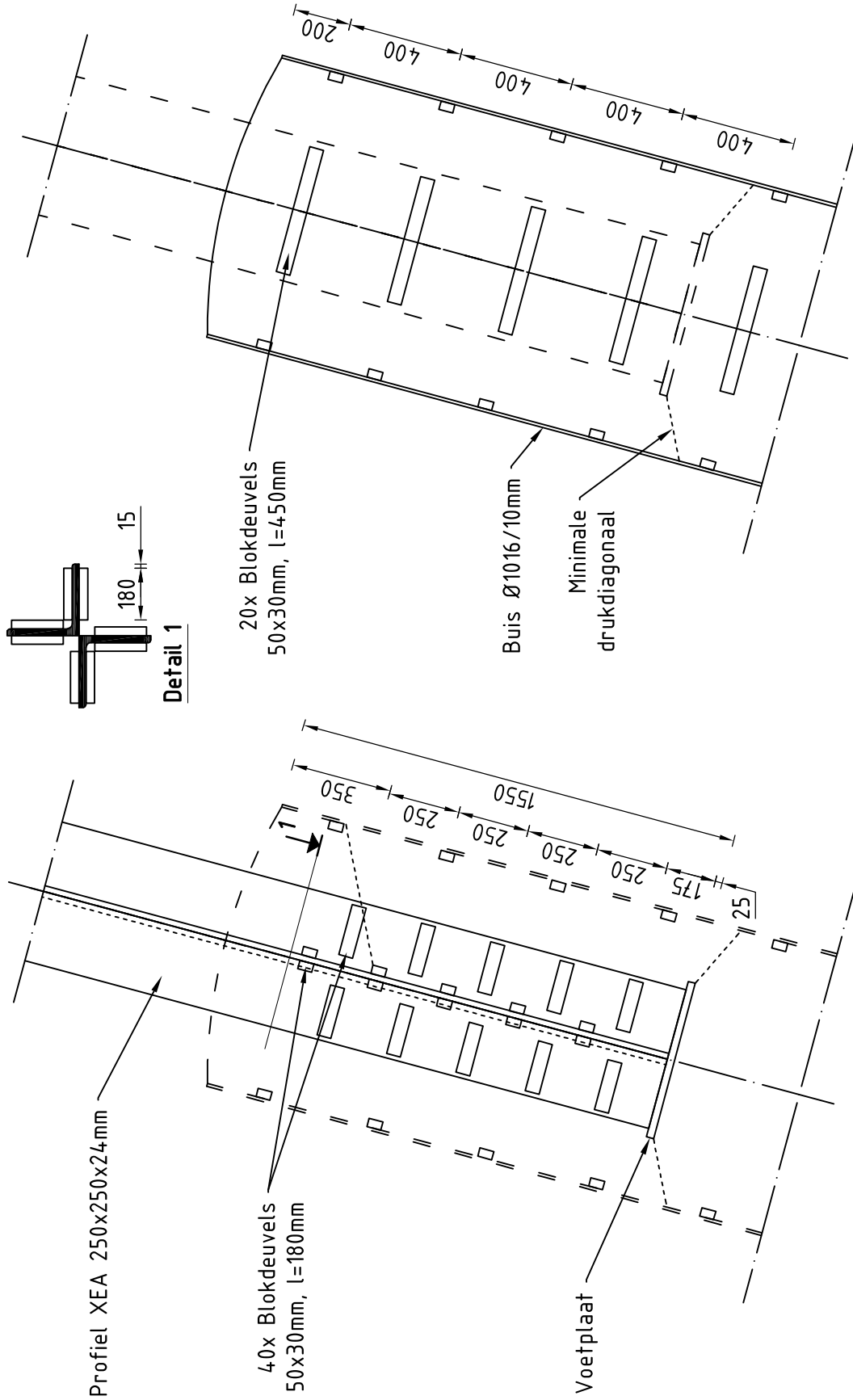

Algemene opmerkingen

- Aarding niet aangegeven
- Spiraalwapening niet aangegeven

Project: RLL-TBG
 Mast: HA-B-C/c & WA-B/c & EA-co

Shear blocks

NEN-EN 1993-1-1 en NEN-EN 1994-1-1

Datum: 2021-07-09

Auteur: TBR

Versie: 1.5

Load			Results		
Compression	$F_{Ed,c}$	5600 kN	Compression	U.C.	0.87 < 1,00 OK
Tension	$F_{Ed,t}$	4800 kN	Tension	U.C.	0.78 < 1,00 OK

Main leg

Profile		XEA 250x250x24
Type		Double (XEA)
Steel material		S355
Cross section		22934 mm ²
Axial capacity	N_{pl}	8142 kN
Width	b	500 mm
Thickness	t	24 mm
Length in concrete		1550 mm

Capacity shear blocks main leg

$A_{f1} = A_{f1,out} + A_{f1,in} =$	10800 mm ²
$A_{f2} = A_{f2,out} + A_{f2,in} =$	31807.5 mm ²
Slope	1 : 5
$C_A = \sqrt{(A_{f2}/A_{f1})} =$	1.72
$f_{jd} = C_A \times f_{cd} =$	25.8 N/mm ²
$F_{Rd,c} = n_c \times A_{f1} \times f_{jd} =$	4459 kN
$F_{Rd,t} = n_t \times A_{f1} \times f_{jd} =$	4459 kN

Shear blocks main leg

Sides		2
Width	b	50 mm
Thickness	h	30 mm
Length - outside	L_{out}	180 mm
Length - inside	L_{in}	180 mm
Eccentricity	e	15 mm
Welds	a	5 mm
c.t.c. separation	s	250 mm
Number for compr.	n_c	16 -
Number for tension	n_t	16 -

Capacity foot plate

$k_d =$	1.73 -
$f_{jd} = C_A \times f_{cd} =$	26.0 N/mm ²
$c = t\sqrt{(f_{yd} / 3f_{jd})} =$	53 mm
$m^* = \min(c, m) =$	30 mm
Type foot plate	Extending
Effective for	Compr. and tension
$A_{p,c} =$	86534 mm ²
$F_{Rd,c} = A_{p,druk} \times f_{jd} =$	2254 kN
$A_{p,t} =$	63600 mm ²
$F_{Rd,t} = A_{p,t} \times f_{jd} =$	1657 kN

Foot plate

Thickness	t	25 mm
Ext. length	m	30 mm
Welds	a	5 mm

Capacities

$F_{rd,c,plate} =$	2254 kN
$F_{rd,blocks,c} =$	4459 kN
$F_{rd,c} = F_{rd,blk} + F_{rd,footplate} =$	6713 kN
U.C. compression	0.83 < 1,00 OK
Welds foot plate (see next page)	2454 kN
$F_{rd,t} = \min. (\text{welds} / \text{foot plate}) =$	1657 kN
$F_{rd,blocks,t} =$	4459 kN
$F_{rd,t} = F_{rd,blk} + F_{rd,footplate} =$	6116 kN
U.C. tension	0.78 < 1,00 OK
U.C. welds	0.47 < 1,00 OK

Pile

Name		Buispaal
Diameter		1016 mm
Thickness		10 mm
Cross section		31604 mm ²
Steel material		S355
Capacity		11220 kN
Concrete strength		C30/37

Shear blocks pile

Width	b	50 mm
Thickness	h	30 mm
Length	L	450 mm
Welds	a	5 mm
c.t.c. separation	s	400 mm
Number for compr.	n_c	16 -
Number for tension	n_t	16 -
Blocks per row	n_{bl}	4 -
Effectivity of total	C_{red}	100% -

Capacity shear blocks pile

$A_{f1} =$	13500 mm ²
$A_{f2} =$	53076 mm ²
$C_A = \sqrt{(A_{f2}/A_{f1})} =$	1.98 -
$f_{jd} = k_d \times f_{cd} =$	29.8 N/mm ²
$F_{Rd,c} = n_c \times A_{f1} \times f_{jd} \times C_{red} =$	6440 kN
U.C. compression	0.87 < 1,00 OK
$F_{Rd,t} = n_t \times A_{f1} \times f_{jd} \times C_{red} =$	6440 kN
U.C. tension	0.75 < 1,00 OK
U.C. welds	0.45 < 1,00 OK

Design value concrete strength

Material factor	γ_c	1.5
Add. mat. factor	γ_m	1.33 -
$f_{cd} =$		15.0 N/mm ²

"Splitting" of pile

Spread of forces		45 °
Length force flow		1052 mm
Splitting force		2281 kN/m
Yield strength wall	$f_{yd} =$	355 N/mm ²
Capacity tubular pile		7100 kN/m
U.C.		0.32 < 1,00 OK

Steel tower stub

Yield strength	$f_{yd} =$	355 N/mm ²
Tensile strength	$f_{ud} =$	490 N/mm ²

Project: RLL-TBG
 Mast: HA-B-C/c & WA-B/c & EA-co

Welds of shear blocks of main leg

Out-of-plane loading

Plate

t = 50 mm
 Grade S355
 $f_{yd} = 355 \text{ N/mm}^2$
 $f_u = 490 \text{ N/mm}^2$

Member forces

Factor 1.2
 $F_{t,Ed} = 0 \text{ kN}$
 $F_{v,Ed} = F_{rd,c} / n = 334 \text{ kN}$
 $F_{v//,Ed} = 0 \text{ kN}$
 $M_{Ed} = 1/2 b / h \times F_{v,Ed} = 5.02 \text{ kNm}$

Check

$\sigma_{w,Ed} = 203 \text{ N/mm}^2 \leq$
 $\sigma_1 = 102 \text{ N/mm}^2 \leq$

Welds

a = 5 mm
 l = 360 mm
 $\beta_w = 0.9 -$
 $\gamma_{M2} = 1.25 -$

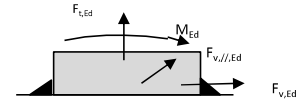

Stress components

$\sigma_1 = \tau_1 = F_{t,Ed} \sqrt{2} / 4al = 0 \text{ N/mm}^2$
 $\sigma_1 = \tau_1 = F_{v,Ed} \sqrt{2} / 4al = 66 \text{ N/mm}^2$

 66 N/mm^2
 $b^* = b + 2/3av^2 = 54.7 \text{ mm}$
 $\sigma_1 = \tau_1 = 0.706M_{Ed} / al b^* = 36 \text{ N/mm}^2$
 $\tau_{//} = F_{v//,Ed} / 2al = 0 \text{ N/mm}^2$
 $\sigma_{w,Ed} = \sqrt{(\sigma_1^2 + 3\tau_1^2 + 3\tau_{//}^2)} = 203 \text{ N/mm}^2$

$f_u / \beta_w \gamma_{M2} = 436 \text{ N/mm}^2$ U.C. = **0.47 OK**
 $0.9f_u / \gamma_{M2} = 353 \text{ N/mm}^2$ U.C. = **0.29 OK**

Welds of shear blocks of pile

Out-of-plane loading

Plate

t = 50 mm
 Grade S355
 $f_{yd} = 355 \text{ N/mm}^2$
 $f_u = 490 \text{ N/mm}^2$

Member forces

Factor 1.2
 $F_{t,Ed} = 1/2 b / h \times F_{v,Ed} = 145 \text{ kN}$
 $F_{v,Ed} = 483 \text{ kN}$
 $F_{v//,Ed} = 0 \text{ kN}$
 $M_{Ed} = 0.00 \text{ kNm}$

Check

$\sigma_{w,Ed} = 197 \text{ N/mm}^2 \leq$
 $\sigma_1 = 99 \text{ N/mm}^2 \leq$

Welds

a = 5 mm
 l = 450 mm
 $\beta_w = 0.9 -$
 $\gamma_{M2} = 1.25 -$

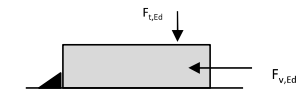

Stress components

$\sigma_1 = \tau_1 = F_{t,Ed} \sqrt{2} / 2al = 23 \text{ N/mm}^2$
 $\sigma_1 = \tau_1 = F_{v,Ed} \sqrt{2} / 2al = 76 \text{ N/mm}^2$

 76 N/mm^2
 $\tau_{//} = F_{v//,Ed} / 2al = 0 \text{ N/mm}^2$
 $\sigma_{w,Ed} = \sqrt{(\sigma_1^2 + 3\tau_1^2 + 3\tau_{//}^2)} = 197 \text{ N/mm}^2$

$f_u / \beta_w \gamma_{M2} = 436 \text{ N/mm}^2$ U.C. = **0.45 OK**
 $0.9f_u / \gamma_{M2} = 353 \text{ N/mm}^2$ U.C. = **0.28 OK**

Welds of foot plate

$f_u / \beta_w \gamma_{M2} = 436 \text{ N/mm}^2$
 Weld size a = 5 mm
 Length l = 2b + 2b - t = 1952 mm
 Capacity $F_{Rd} = a \times l \times f_{w,d} / \sqrt{3} = 2454 \text{ kN}$



APPENDIX E

Liggers

1 BEREKENING OPHANGING POSTISOLATOREN

De volgende onderdelen worden berekend:

- De belastingen op de ophanging van de postisolatoren door wind en eigen gewicht;
- De dimensionering van de ophangconstructies.

Onderstaand zijn de optredende belastingen geschematiseerd:

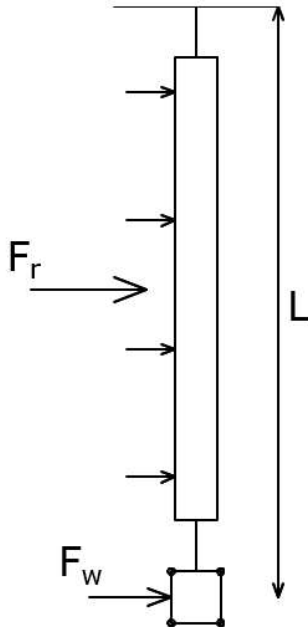

Figuur 1 Belastingeschema

1.1 Uitgangspunten & afmetingen postisolatoren

Voor het berekenen van de liggers voor de ophanging van de postisolatoren in de mastkoppen van de HA-masten wordt één berekening gemaakt met de volgende uitgangspunten:

- Windgebied II;
 - Windhoogte 54,5m (gebaseerd op hoogste mast HA+6/c);
 - Onbebouwd;
- Referentieperiode 50 jaar;
- Belastingfactor 1,5.

De volgende factoren worden gehanteerd:

- Krachtcoëfficiënt 1,2 voor isolatoren
- Constructiefactor geleider 1,0;
- Krachtcoëfficiënt geleider 1,0;
- Constructiefactor geleider 1,0.

Conform het uitgangspuntendocument zijn de afmetingen als volgt:

Tabel 1 Gegevens postisolatoren

Omschrijving	Ophanging	Gewicht [kN]	Lengte [m]	Windopp. [m]
Fasegeleider 380 kV	Bretelfixatie	2,0	4,5	1,0
Fasegeleider 150 kV	Bretelfixatie	1,5	2,7	0,7

De diameter van de geleiders is 32mm.

1.2 Belastingen

De extreme stuwdruk $q_{p(z)}$ in windgebied II op een hoogte van 54,5m is 1,41kN/m².

Er komen drie varianten voor:

1. 380 kV geleider met één postisolator;
 - Lengte geleider aan postisolator ca. 9 m;
2. 150 kV geleider met één postisolator;
 - Lengte geleider aan postisolator ca. 7 m;
3. 150 kV geleider met twee postisolatoren;
 - Lengte geleider aan postisolator ca. 3,5 m.

In het horizontale vlak bestaat er een afstand tussen het uiteinde van de afspanketting en de postisolator (zie figuur 2). Dit veroorzaakt een extra horizontale kracht vanuit de bretelle op de onderzijde van de postisolator (zie figuur 3). Het gewicht van de bretelle (380kV) is gelijk aan $(4 \times 17,7\text{N/m}) = 70,8\text{N/m}$. De horizontale kracht evenwijdig aan de brettelle is gelijk aan:

$$\bullet F_{h,evenw} = \frac{1}{8} \cdot q \cdot L^2 / u = \frac{1}{8} \cdot 0,0708\text{kN/m} \cdot (7,62\text{m})^2 / 1,2\text{m} = 0,4 \text{ kN.}$$

De horizontale kracht loodrecht op de postisolator is gelijk aan:

$$\bullet F_{h,gel} = 2 \cdot 0,4\text{kN} \cdot 3,75\text{m} / 7,62\text{m} = 0,4 \text{ kN.}$$

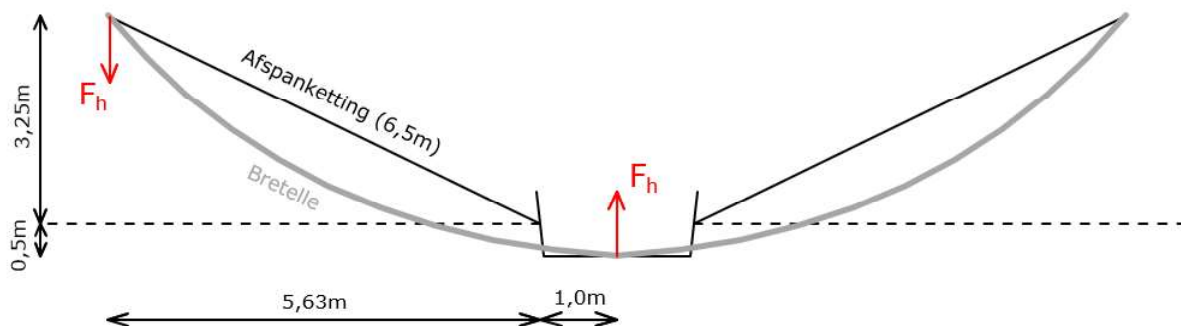

Figuur 2 Bovenaanzicht bretelle

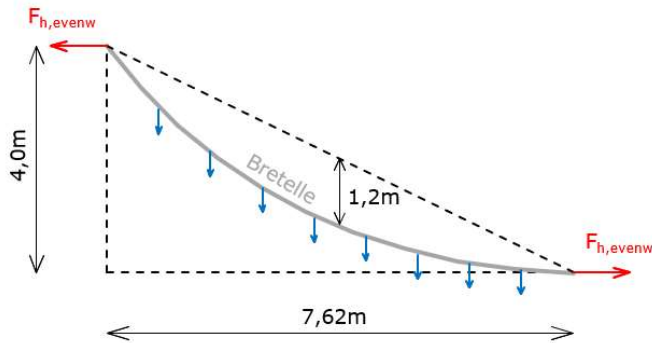

Figuur 3 Zij-aanzicht bretelle

Voor het 180kV-circuit wordt dezelfde berekening gemaakt. De afspanketting heeft een lengte van 4,0m en de tussen afstand is 2 x 2m (i.p.v. 2 x 1m). De postisolator hangt 1,0m naar buiten en de horizontale afstand (ten gevolge van de hoek) is gelijk aan $(\sin(30^\circ) \cdot 4m) = 2m$. De lengte is dan gelijk aan $(\sqrt{(\cos(30^\circ) \cdot 4m + 2m)^2 + (2m + 1m)^2}) = 6,23m$. De krachten zijn dan gelijk aan:

- $F_{h,evenw} = \frac{1}{8} \cdot q \cdot L^2 / u = 1/8 \cdot 0,0354kN/m \cdot (6,23m)^2 / 0,8m = 0,2 \text{ kN};$
- $F_{h,gel} = 2 \cdot 0,4kN \cdot 3,0m / 6,23m = 0,2 \text{ kN}.$

Belasting bij wind loodrecht op de geleider

Voor elke variant zijn in onderstaande tabellen de optredende reactiekrachten (F_h , $F_{v,tot}$ en M_{tot}) op het ophangpunt van de postisolator berekend.

Tabel 2 Optredende belastingen per variant – wind loodrecht

Var.	$q_p(z)$ [kN/m ²]	G_{post} [kN]	L_{post} [m]	Opp [m ²]	n_{gel} [n]	\emptyset_{gel} [m]	G_{gel} [kN/m]	L_{gel} [m]	$F_{h,gel}$ [kN]
1	1,41	2	4,5	1	4	0,032	0,0177	9	0,4
2	1,41	1,5	2,7	0,7	2	0,032	0,0177	7	0,2
3	1,41	1,5	2,7	0,7	2	0,032	0,0177	3,5	0,1

Var.	$C_{f,r}$ [-]	S_r [-]	$F_{r,k}$ [kN]	$M_{r,k}$ [kNm]	$C_{f,w}$ [-]	S_w [-]	$F_{w,k}$ [kN]	$M_{w,k}$ [kNm]
1	1,2	1	1,69	3,81	1	1	1,62	7,31
2	1,2	1	1,18	1,60	1	1	0,63	1,71
3	1,2	1	1,18	1,60	1	1	0,32	0,85

Var.	γ [-]	$F_{v,Ed}$ [kN]	$F_{h,tot,Ed}$ [kN]	$M_{tot,Ed}$ [kNm]
1	1,5	4,0	5,6	19,4
2	1,5	2,6	3,0	5,8
3	1,5	2,4	2,4	4,1

Belasting bij wind evenwijdig aan de geleider

Waar relevant wordt er ook getoetst aan wind evenwijdig aan de geleider. In onderstaande tabel zijn de optredende krachten weergegeven.

Tabel 3 Optredende belastingen per variant – wind evenwijdig

Var.	L _{post} [m]	F _{h,gel} [kN]	M _{r,-,k} [kNm]	F _{r,k} [kN]	M _{r,/,k} [kNm]	F _{v,Ed} [kN]	F _{h,-,Ed} [kN]	M _{r,-,Ed} [kNm]	F _{h,/,Ed} [kN]	M _{r,/,Ed} [kNm]
1	4,5	0,4	1,8	1,69	3,81	4,0	0,6	2,7	2,5	5,7
2	2,7	0,2	0,54	1,18	1,60	2,6	0,3	0,8	1,8	2,4
3	2,7	0,1	0,27	1,18	1,60	2,4	0,2	0,4	1,8	2,4

2 VARIANT 1 – 380 KV – 1 POSTISOLATOR

De ophanging van de postisolator bij variant 1 kent twee varianten:

- A. Ophanging aan enkele ligger (onderstaand links);
- B. Ophanging aan frame (onderstaand rechts).

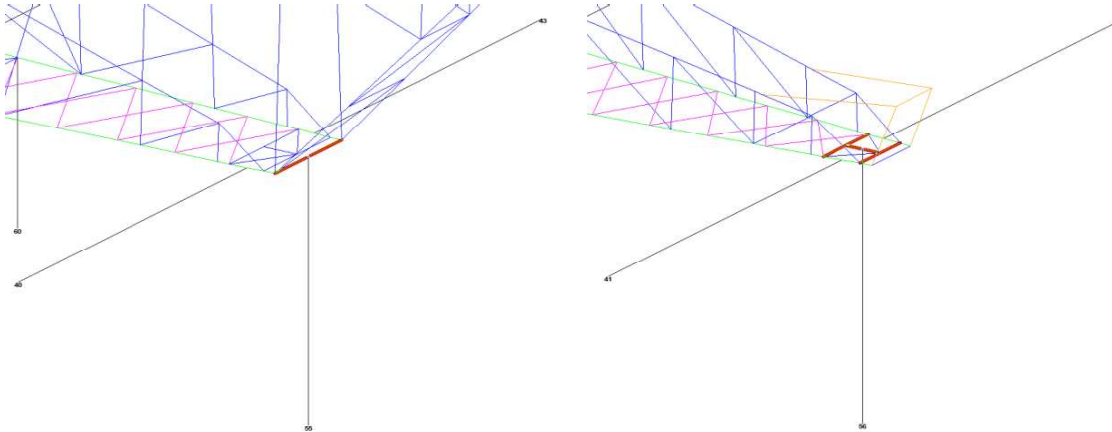

Figuur 4 Principe ophanging variant 1A (links) en 1B (rechts)

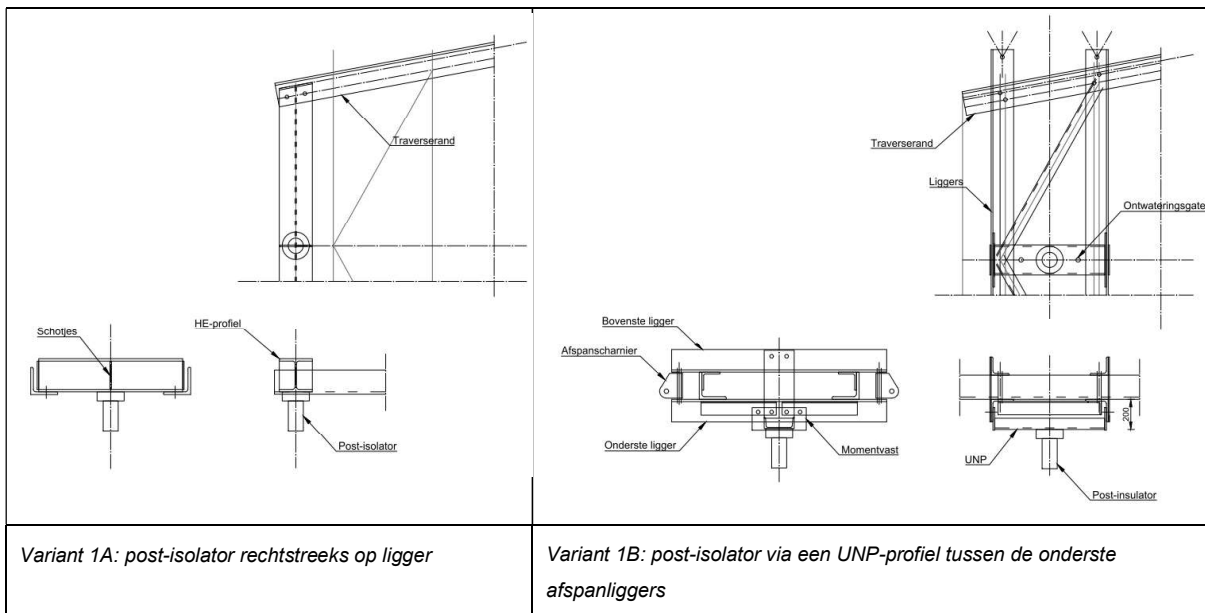

Figuur 5 Principedetails voor bevestiging post-insulator variant 1A en 1B

2.1 Variant A

De postisolator wordt opgehangen aan een enkele stalen ligger. Deze ligger wordt daardoor in twee richtingen en op torsie belast. De optredende belastingen zijn:

- Verticaal F_v 4,0 kN;
- Horizontaal $F_{h,tot}$ 5,6 kN;
- Torsiemoment M_{tot} 19,4 kNm.

De maximale lengte van de ligger is 1,82m (boventraverse HA+0/s). Het profiel van de ligger is HEB220 (S355). De ligger wordt getoetst aan de hand van een excel-sheet. Uit berekening blijkt dat de ligger voldoet met een maximale UC van 0,78. Voor berekening, zie na pagina 6.

2.2 Variant B

Onderstaand is de situatie schematisch weergegeven. De hoeklijnen hebben een (minimale) doorsnede van 150x150x14mm. De afstand tussen de hoeklijnen is 600mm. De bovenste en onderste hoeklijnen worden halverwege de overspanning gekoppeld.

De optredende maximale reactiekracht is gelijk aan $(4,0\text{kN}/2 + 19,4\text{kNm}/0,6\text{m}) = 34,3\text{kN}$. Per ligger is de kracht gelijk aan $(34,3\text{kN} / 2 =) 17,2\text{kN}$.

De maximale overspanning is 2,5m (middentraverse HA+0/c → 150kV heeft langste ligger, deze als maatgevend aangehouden). Het totale moment in het hoekstaal wordt dan $(0,25 \cdot (17,2\text{kN} + 5,3\text{kN}/2) \cdot 2,5\text{m}) = 12,4\text{kNm}$.

Het weerstandsmoment is gelijk aan 83500mm^3 . De spanning is gelijk aan $(12,4 \cdot 10^6 \text{ Nmm} / 83500\text{mm}^3 =) 158\text{MPa}$. De ligger voldoet met een UC van $(158\text{MPa} / 355\text{MPa} =) 0,45$.

De ligger die hoeklijnen koppelt heeft een doorsnede van UNP220 en wordt om de zwakke as belast. Het optredende moment is gelijk aan $(1/4 \cdot 4,0\text{kN} \cdot 0,6\text{m} + 1/2 \cdot 19,4\text{kNm}) = 10,3\text{kNm}$. De spanning is gelijk aan $(10,3 \cdot 10^6 \text{ Nmm} / 33500\text{mm}^3 =) 307\text{MPa}$. De ligger voldoet met een UC van $(307\text{MPa} / 355\text{MPa} =) 0,86$.

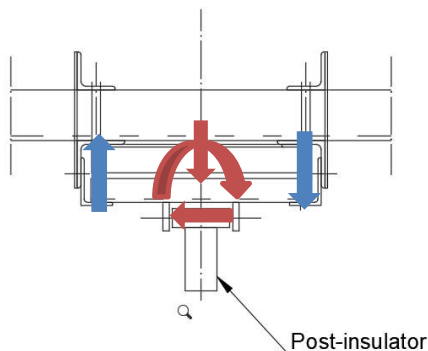

Figuur 6 Schematische weergave ophanging variant 1B

3 VARIANT 2 – 150 KV – 1 POSTISOLATOR

Bij deze variant wordt de postisolator opgehangen aan een frame, dit komt overeen met variant 1B. De optredende belastingen zijn:

- Verticaal F_v 2,6 kN;
- Horizontaal $F_{h,tot}$ 3,0 kN;
- Torsiemoment M_{tot} 5,8 kNm.

De belastingen zijn lager en de liggers maximaal even lang als bij variant 1B. Voor variant 2 voldoen profielen 150x150x14mm dus ook, voor uitwerking zie variant 1B.

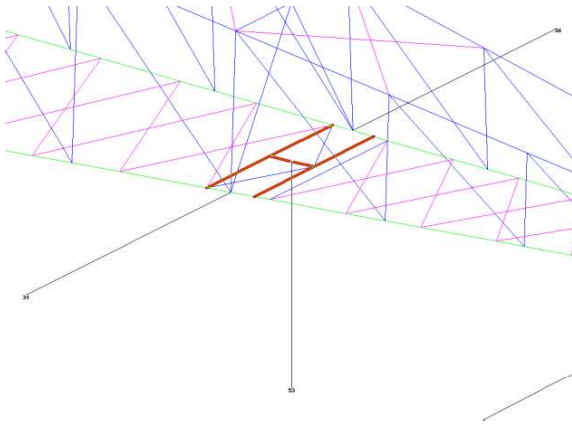

Figuur 7 Principe ophanging variant 2

4 VARIANT 3 – 150 KV – 2 POST-ISOLATOR

De postisolator wordt via een verlaagde console ingeklemd in twee richtingen opgehangen aan de onderrand van de traverse. De torsie op de onderrand wordt opgenomen door een ligger uit HE-profiel (diagonalen worden verwaarloosd), in de richting van de onderrand neemt de rand de momenten op. De optredende belastingen zijn:

- Verticaal F_v 2,4 kN;
- Horizontaal $F_{h,tot}$ 2,4 kN;
- Torsiemoment M_{tot} 4,1 kNm.

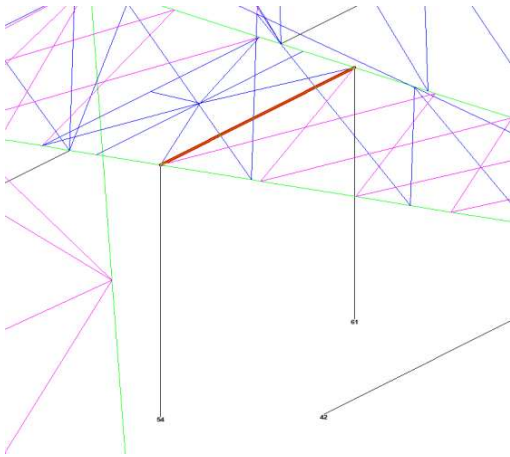

Figuur 8 Principe ophanging variant 3

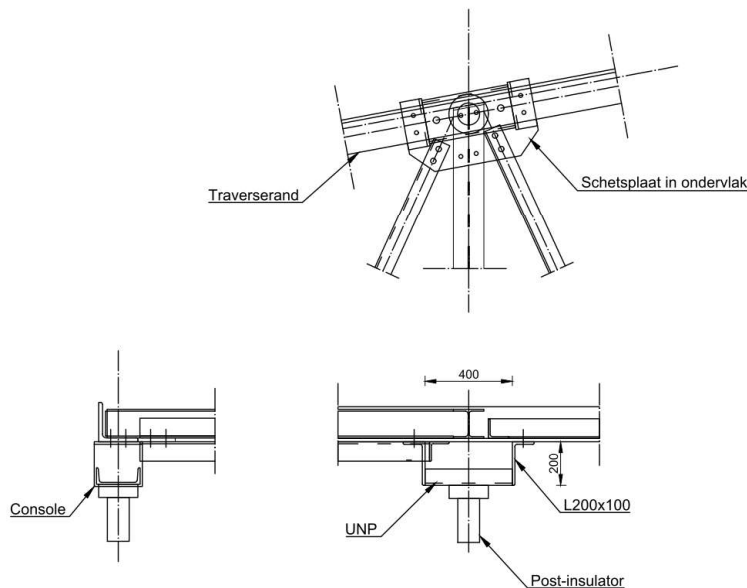

Figuur 9 Principedetail bevestiging post-isolator aan rand

De ligger wordt belast door een kopmoment. Dit moment is volgens Tabel 3 gelijk aan 2,4 kNm. Ligger met praktisch gekozen profiel HE140A volstaat.

Kritisch aspect in de verbinding is de krachtsoverdracht van het buigend moment uit het vlak van de console naar de ligger. De onderrand wordt lokaal (tussen de console en HE-ligger) op torsie belast en de flens van het hoekprofiel

wordt ook op buiging belast. Om de krachtsinleiding mogelijk te maken wordt de onderrand verstijfd met een schetsplaat waarmee de HE-ligger en diagonalen worden verbonden.

De controle is uitgevoerd met het programma AxisVM. Zowel buiging in het vlak als buiging uit het vlak is gecontroleerd. Als minimaal profiel van de onderrand is uitgegaan van L150x150x14. De maximale drukkracht in de rand is in combinatie met de buiging meegenomen.

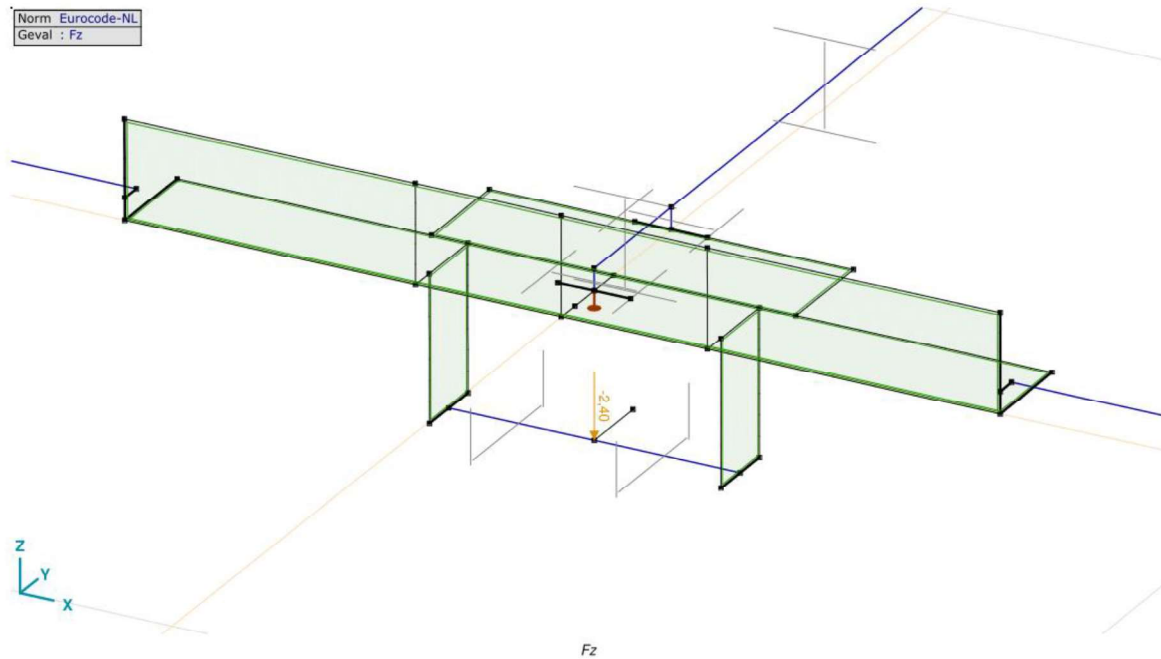

Figuur 10 Rekenmodel krachtsinleiding post-isolator aan onderrand

De belastingen zijn ontleend aan Tabel 2 en Tabel 3 voor de 150 kV post-isolator. De belastingen zijn in AxisVM gecombineerd met het verticale gewicht, en met twee richtingen van M_x en M_y , waarbij belastinggevallen zijn verminderd tot een factor 0,71.

Tabel 4 Belastingen op console

Var.	$F_{z,Ed}$ [kN]	$F_{x,Ed}$ [kN]	$F_{y,Ed}$ [kN]	$M_{x,Ed}$ [kNm]	$M_{y,Ed}$ [kNm]
M_x			1,8	2,4	
M_y		3,0			5,8
F_z	2,4				
N	600				

Uit de berekening blijkt dat de combinatie van spanningen door torsie en buiging toelaatbaar is.

Lineaire berekening	
Norm	Eurocode-NL
Geval	Co #3
E (P)	: 2,64E-9
E (W)	: 2,64E-9
E (Eq)	: 2,76E-7
Comp.	: SVM T [N/mm ²]

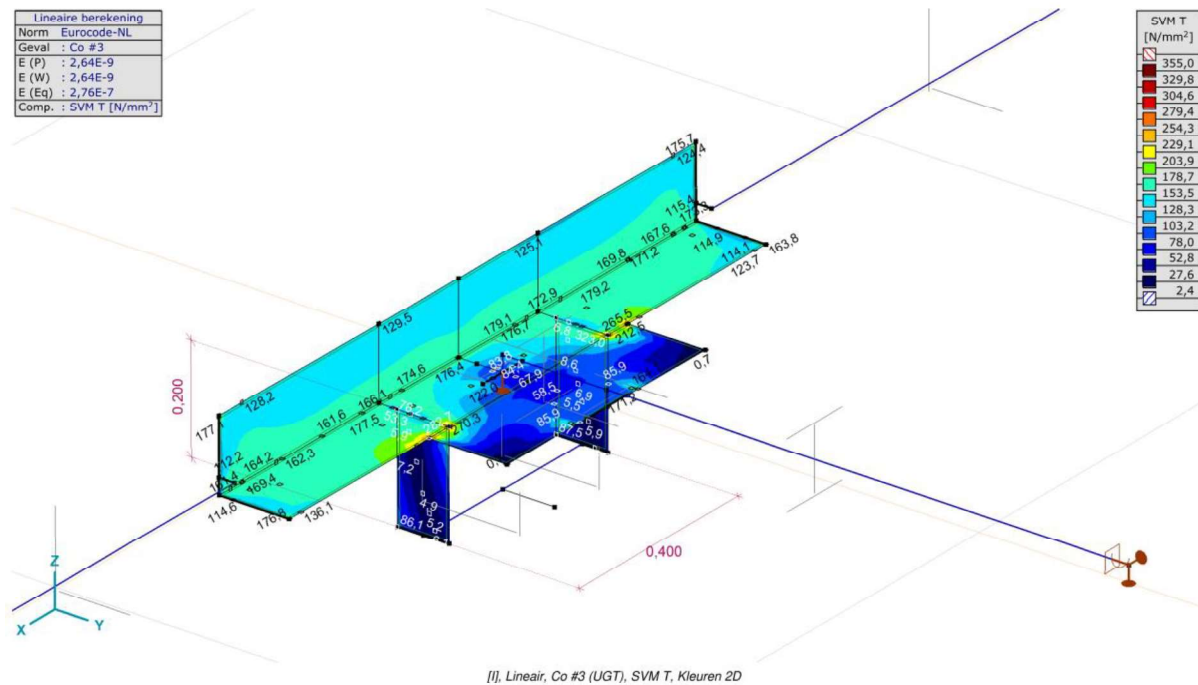

[I], Linear, Co #3 (UGT), SVM T, Kleuren 2D

Figuur 11 Spanningen in de maatgevende belastingcombinatie

In het model treden elastisch berekend bij hoeken spanningsconcentraties op. Zie Figuur 11. In de uitvoer opgenomen in de bijlage blijkt dat de hoogste spanning 323 N/mm² bedraagt. De toetsing is:

$$U.C. = 323 \text{ N/mm}^2 / 355 \text{ N/mm}^2 = 0,91 \leq 1,00 \text{ OK.}$$

De staalprofielen voldoen.

Project:

Constructeur: DNV GL - Energy

AxisVM X5 R4h · Geregistreerd aan DNV GL - Energy
Model 1.axs

Rapport

Rapport, Inhoudsopgave

	<i>Onderdeel</i>	<i>Pagina</i>	<i>Onderdeel</i>	<i>Pagina</i>
Tekening		3	Gebruiker gedefinieerde belastingcombinaties uit belastinggevallen	14
Tekening2		4	[I], Linear, Co #1 (UGT), SVM T, Kleuren 2D	15
Materialen		5	[I], Linear, Co #2 (UGT), SVM T, Kleuren 2D	16
Domeinen		5	[I], Linear, Co #1 (UGT), SVM C, Kleuren 2D	17
Lijnopleggingen		6	[I], Linear, Co #2 (UGT), SVM C, Kleuren 2D	18
Fx		7	[I], Linear, Co #1 (UGT), eY, Lijnen	19
Fx: Oppervlak lijnlast		8	[I], Linear, Co #2 (UGT), eY, Lijnen	20
Fy1		9	[I], Linear, Co #1 (UGT), eZ, Lijnen	21
Fy1: Oppervlak lijnlast		10	[I], Linear, Co #2 (UGT), eZ, Lijnen	22
Fy2		11	[I], Linear, Co #1 (UGT), Ry (lijnoppl.), Doorsnedelij	23
Fy2: Oppervlak lijnlast		12	[I], Linear, Co #2 (UGT), Ry (lijnoppl.), Doorsnedelij	24
Fz		13	[I], Linear, Co #1 (UGT), Rz (lijnoppl.), Doorsnedelij	25
Fz: Oppervlak lijnlast		14	[I], Linear, Co #2 (UGT), Rz (lijnoppl.), Doorsnedelij	26

Project:

Constructeur: DNV GL - Energy

Model: **Model 1.axs**

21-2-2021

Pag. 3

Norm Eurocode-NL

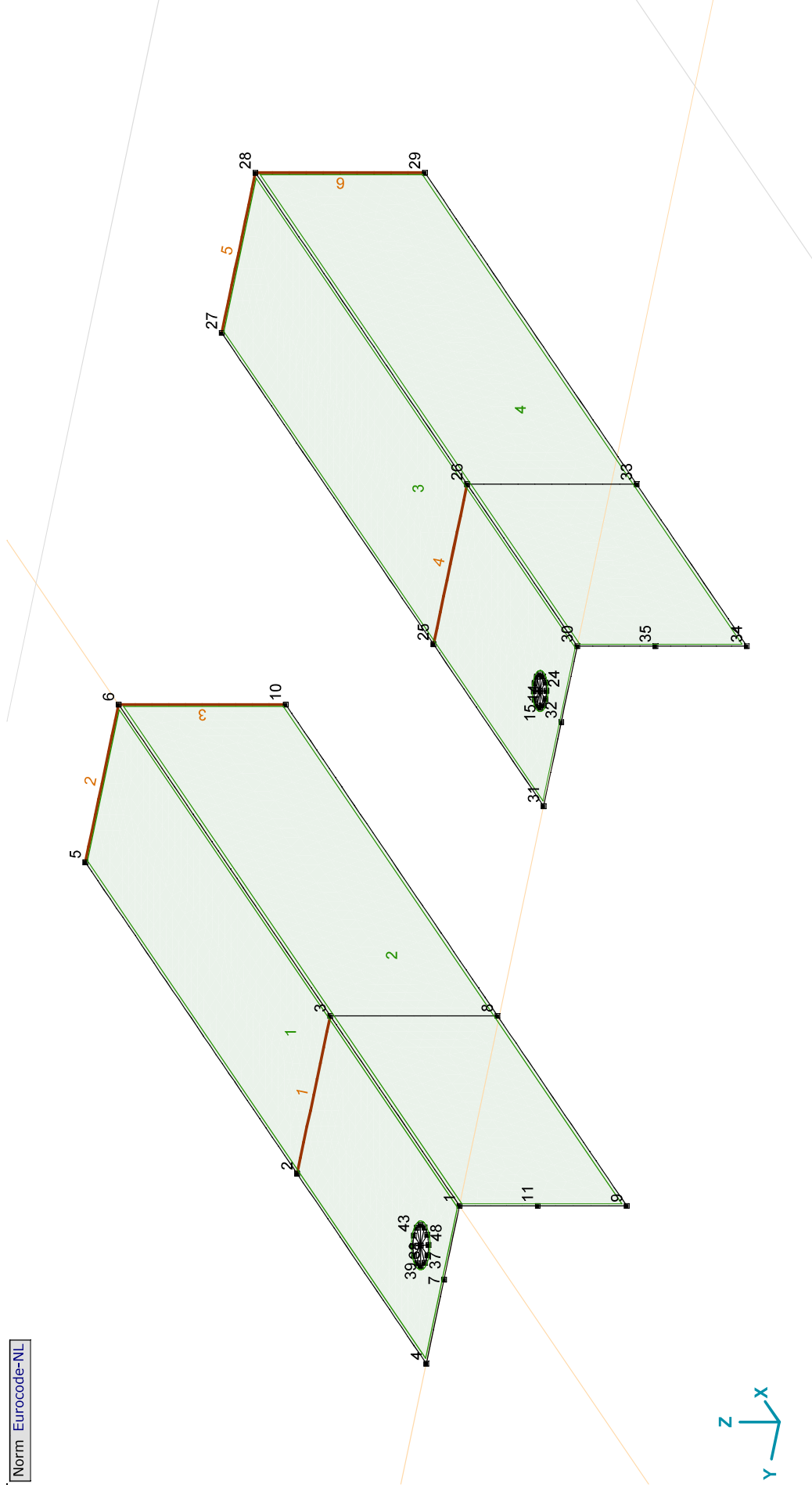

Tekening

Project:

Constructeur: DNV GL - Energy

Model: **Model 1.axs**

Norm Eurocode-NL

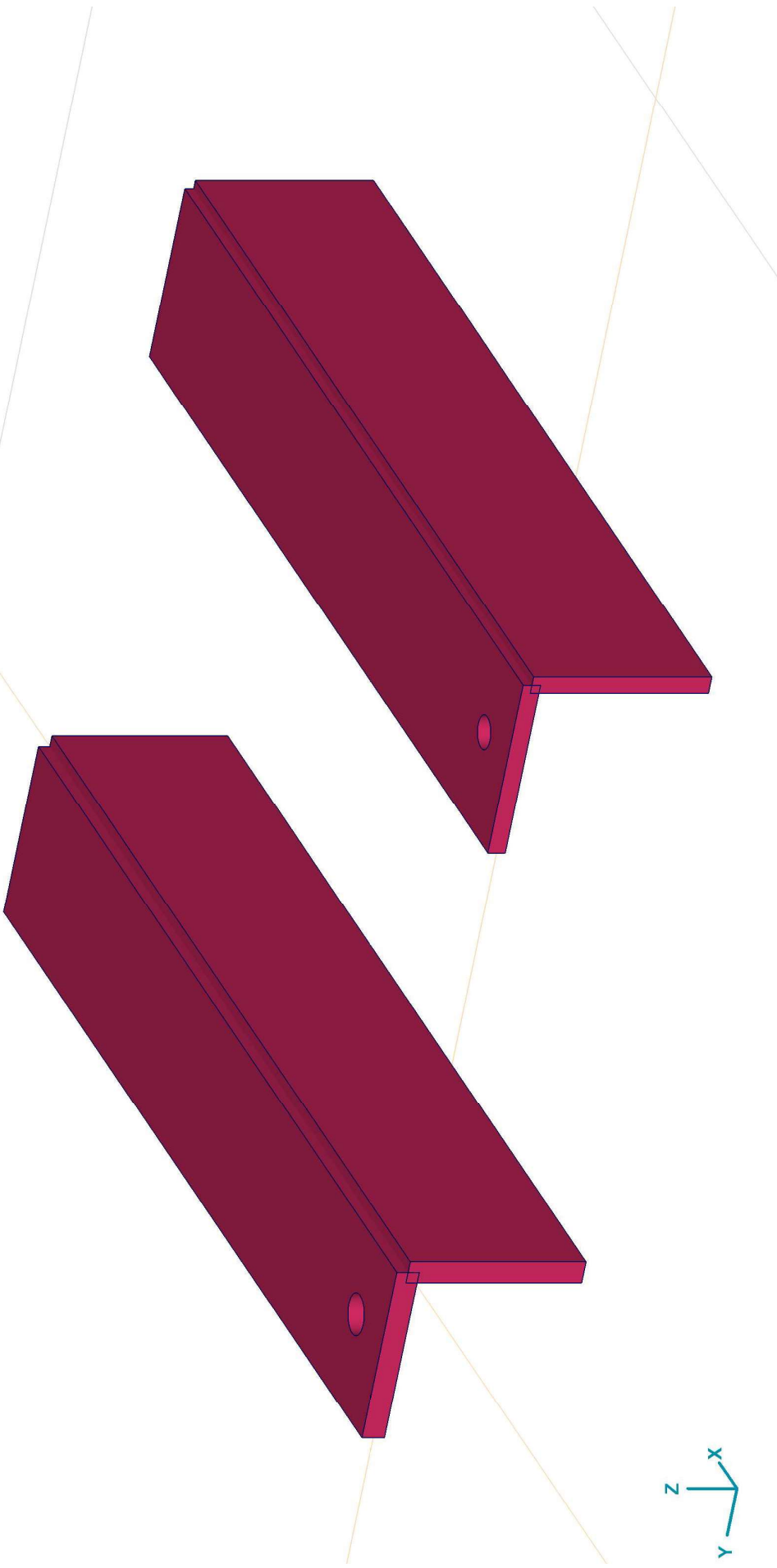

Tekening2

Project:



Constructeur: DNV GL - Energy

Model: **Model 1.axs**

21-2-2021

Pag. 5

Materialen

Naam	Type	Nationale norm	Materiaalnorm	Model	E_x [N/mm ²]	E_y [N/mm ²]	ν	α_T [1/°C]	ρ [kg/m ³]	Materiaal kleur	Contour kleur	Structuur	
1	S 355	Staal	Eurocode-NL	10025-2	Lineair	210000	210000	0,30	1,2E-5	7850			

Naam	P_1	P_2	P_3	P_4	P_5	P_6	P_7	P_8	P_9	P_{10}	P_{11}	P_{12}	P_{13}	P_{14}
1	S 355	f_y [N/mm ²] = 355,00	f_u [N/mm ²] = 510,00	f_y^* [N/mm ²] = 335,00	f_u^* [N/mm ²] = 470,00									

Naam: Materiaalnaam; Type: Type materiaal; Model: Materiaal model; E_x : Elasticiteitsmodulus in lokale x richting; E_y : Elasticiteitsmodulus in lokale y richting; ν : Poisson's verhouding; α_T : Warmteuitzettingscoëfficiënt; ρ : Dichtheid; **Materiaal kleur**: Materiaalkleur; **Contour Meur**: Contourkleur; $P_1, P_2, P_3, P_4, P_5, P_6, P_7, P_8, P_9, P_{10}, P_{11}, P_{12}, P_{13}, P_{14}$: Ontwerpparameter;

Domeinen

Element type	Materiaal	Ref_x	Ref_z	Dikte [mm]	$k_{buiging}$ //	k_{torsie} //	$k_{afschuiving}$ //	Oppervlakte [m ²]	Gat	Mesh
1	# Schaal S 355	Auto	Auto	18				0,113	1	✓
2	# Schaal S 355	Auto	Auto	18				0,114	-	✓
3	# Schaal S 355	Auto	Auto	14				0,108	1	✓
4	# Schaal S 355	Auto	Auto	14				0,109	-	✓

Element type: Plaalement type; **Ref_x**: Referentie voor lokale X-richting; **Ref_z**: Referentie voor lokale Z-richting; **k_{buiging}**: Buigsterkte coefficient; **k_{torsie}**: Torsiesterkte coefficient; **k_{afschuiving}**: Dwarskrachtsterkte coefficient; **Oppervlakte**: Domein oppervlakte; **Gat**: Aantal gaten in domein; **Mesh**: Gegeneerde mesh;

Project:

Constructeur: DNV GL - Energy

Model: **Model 1.axs**

21-2-2021

Pag. 6

Lijnopleggingen

Lijn	Type	Ref. elem.	Rx [kN/m/m]	Ry [kN/m/m]	Rz [kN/m/m]	Rxx [kNm/rad/m]	Ryy [kNm/rad/m]	Rzz [kNm/rad/m]	NL(x)	NL(y)	NL(z)
1	Rand (2034)	Glob. Domein 1	0	1E+7	1E+7	0	0	0		Symmetrisch	Symmetrisch
2	Rand (1959)	Glob. Domein 1	1E+10	0	0	0	0	0	Symmetrisch		
3	Rand (104)	Glob. Domein 2	1E+10	0	0	0	0	0	Symmetrisch		
4	Rand (3938)	Glob. Domein 3	0	1E+7	1E+7	0	0	0		Symmetrisch	Symmetrisch
5	Rand (3866)	Glob. Domein 3	1E+10	0	0	0	0	0	Symmetrisch		
6	Rand (5718)	Glob. Domein 4	1E+10	0	0	0	0	0	Symmetrisch		

Lijn	NL(xx)	NL(yy)	NL(zz)	F(x) [kN/m]	F(y) [kN/m]	F(z) [kN/m]	M(x) [kNm/m]	M(y) [kNm/m]	M(z) [kNm/m]
1	Rand (2034)								
2	Rand (1959)								
3	Rand (104)								
4	Rand (3938)								
5	Rand (3866)								
6	Rand (5718)								

Lijn: Ondersteund lijnelement; **Type:** Opleggingstype; **Ref. elem.:** Referentie-element; **Rx, Ry, Rz:** Verplaatsingslijfheid; **Rxx, Ryy, Rzz:** Rotatieslijfheid; **NL(x), NL(y), NL(z), NL(xx), NL(yy), NL(zz):** Niet-lineaire parameters; **F(x):** Weerstand in X-richting; **F(y):** Weerstand in Y-richting; **F(z):** Weerstand in Z-richting; **M(x):** Weerstandsmoment in X-richting; **M(y):** Weerstandsmoment in Y-richting; **M(z):** Weerstandsmoment in Z-richting.

Project:

Constructeur: DNV GL - Energy

Model: **Model 1.axs**

21-2-2021

Pag. 7

Norm: Eurocode-NL
Geval: Fx

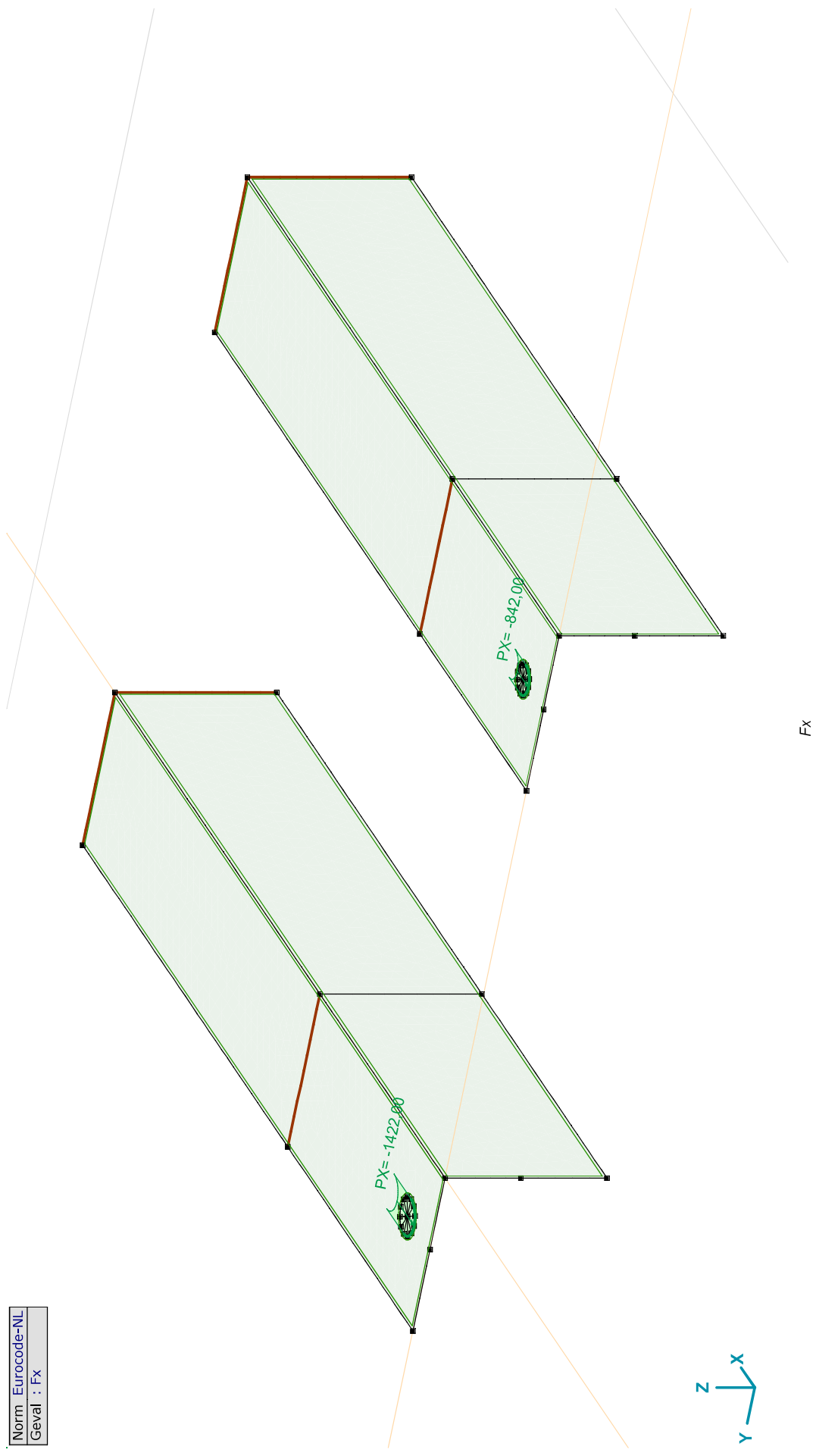

Project:

Constructeur: DNV GL - Energy

Model: **Model 1.axis**

21-2-2021

Pag. 8

Fx: Oppervlak lijnlast

	<i>Richting</i>	p_x [kN/m]	p_y [kN/m]	p_z [kN/m]	p_m [kNm/m]	X [m]	Y [m]	Z [m]	<i>Richting</i>	dL [m]
1	Global	-1422,00	0	0	0	0,055	0,082	0	(0,055; 0,066; 0,000)	0
		-1422,00	0	0	0	0,055	0,050	0	-	0,050
4	Global	-842,00	0	0	0	0,050	-0,419	0	(0,050; -0,432; 0,000)	0
		-842,00	0	0	0	0,050	-0,445	0	-	0,041

p_x , p_y , p_z : Belastingkracht component; **p_m :** Belastingmoment component; **X :** Belasting in X-richting; **Y :** Belasting in Y-richting; **Z :** Belasting in Z-richting;

Project:

Constructeur: DNV GL - Energy

Model: **Model 1.axs**

21-2-2021

Pag. 9

Norm: Eurocode-NL
Geval: FY1

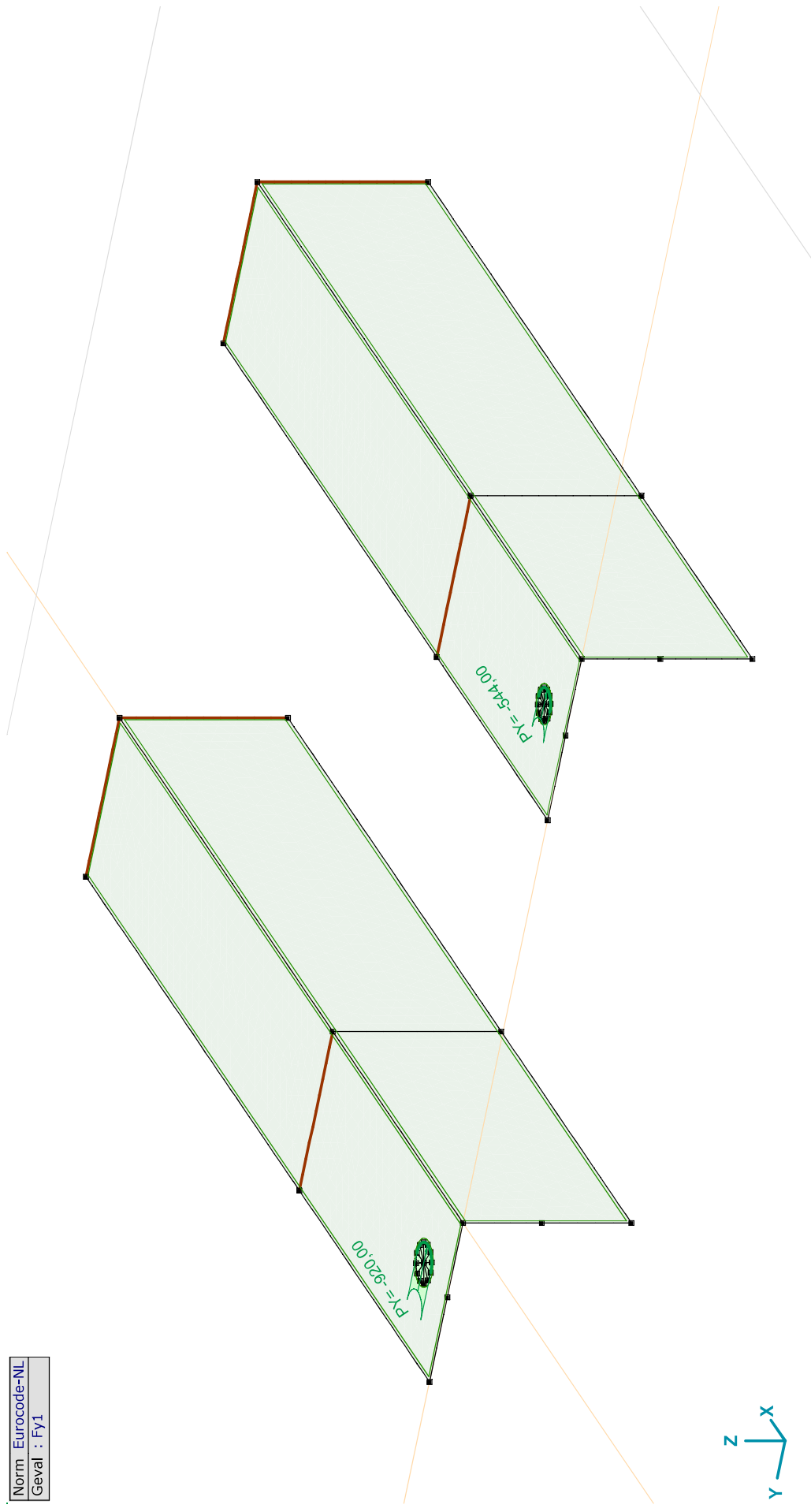

FY1

Project:

Constructeur: DNV GL - Energy

Model: **Model 1.axs**

21-2-2021

Pag. 10

Fy1: Oppervlak lijnlast

	Richting	p_x [kN/m]	p_y [kN/m]	p_z [kN/m]	p_m [kNm/m]	X [m]	Y [m]	Z [m]	Richting	dL [m]
5	Global	0	-920,00	0	0	0,071	0,066	0	(0,055; 0,066; 0,000)	0
		0	-920,00	0	0	0,039	0,066	0	-	0,050
7	Global	0	-544,00	0	0	0,037	-0,432	0	(0,050; -0,432; 0,000)	0
		0	-544,00	0	0	0,063	-0,432	0	-	0,041

p_x , p_y , p_z : Belastingkracht component; **p_m :** Belastingmoment component; **X:** Belasting in X-richting; **Y:** Belasting in Y-richting; **Z:** Belasting in Z-richting;

Project:

Constructeur: DNV GL - Energy

Model: **Model 1.axs**

21-2-2021

Pag. 11

Norm: Eurocode-NL
Geval: FY2

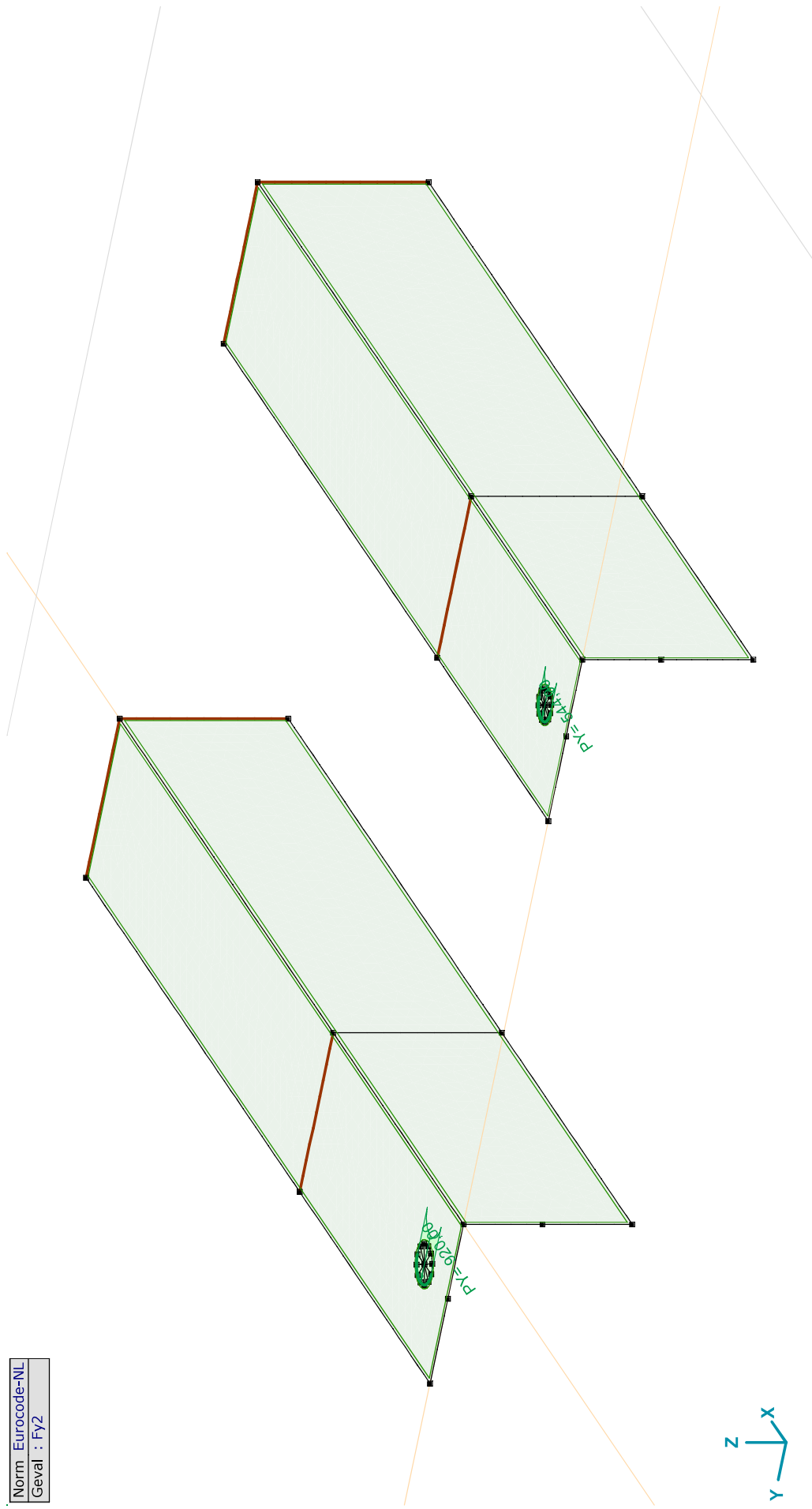

FY2

Project:

Constructeur: DNV GL - Energy

Model: **Model 1.axs**

21-2-2021

Pag. 12

Fy2: Oppervlak lijnlast

	<i>Richting</i>	p_x [kN/m]	p_y [kN/m]	p_z [kN/m]	p_m [kNm/m]	X [m]	Y [m]	Z [m]	<i>Richting</i>	dL [m]
6	Global	0	920,00	0	0	0,071	0,066	0	(0,055; 0,066; 0,000)	0
		0	920,00	0	0	0,039	0,066	0	-	0,050
8	Global	0	544,00	0	0	0,063	-0,432	0	(0,050; -0,432; 0,000)	0
		0	544,00	0	0	0,037	-0,432	0	-	0,041

p_x , p_y , p_z : Belastingkracht component; **p_m :** Belastingmoment component; **X :** Belasting in X-richting; **Y :** Belasting in Y-richting; **Z :** Belasting in Z-richting;

Project:

Constructeur: DNV GL - Energy

Model: Model 1.axs

21-2-2021

Pag. 13

Norm : Eurocode-NL
Geval : Fz

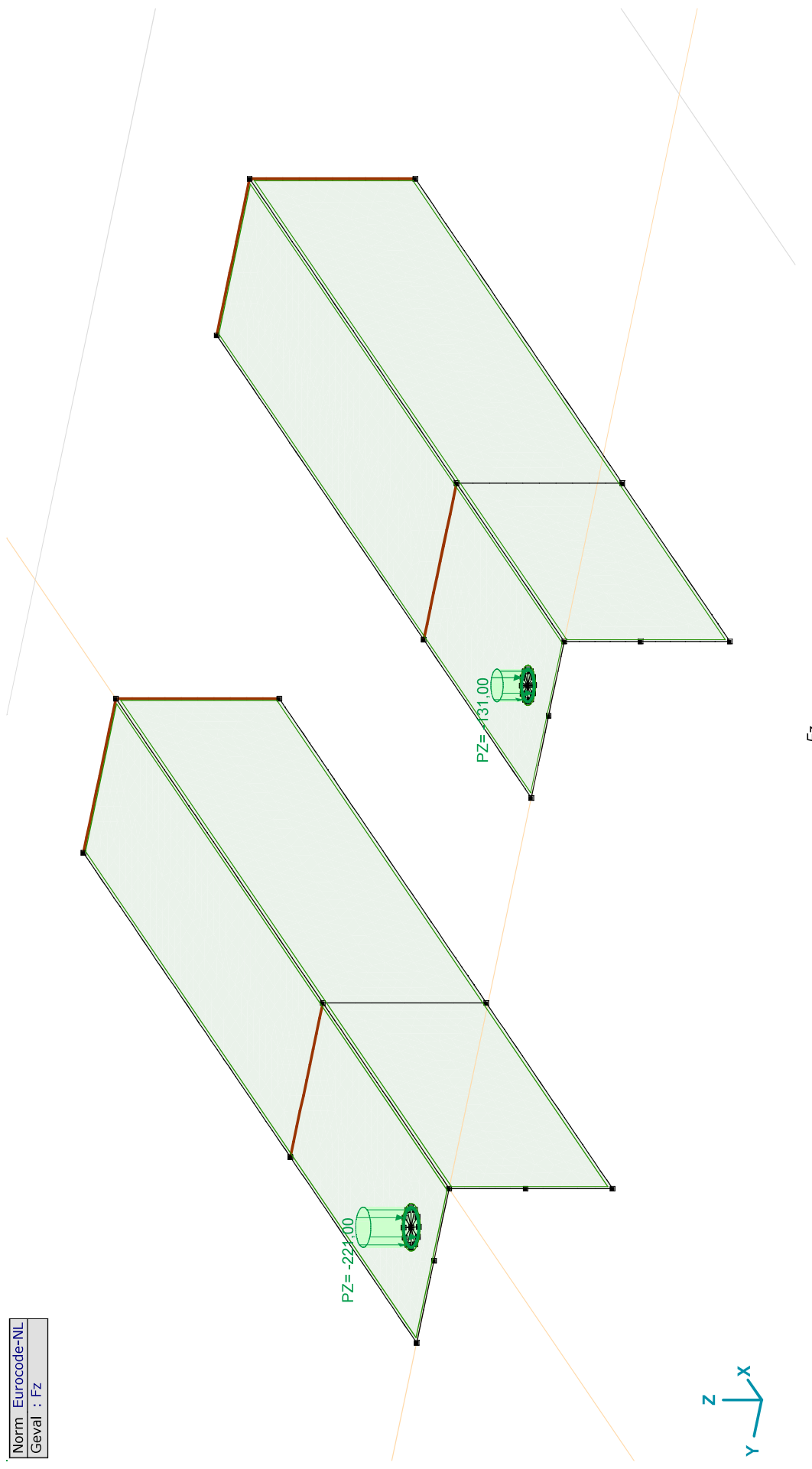

Project:

Constructeur: DNV GL - Energy

Model: **Model 1.axs**

21-2-2021

Pag. 14

Fz: Oppervlak lijnlast

	Richting	p_x [kN/m]	p_y [kN/m]	p_z [kN/m]	p_m [kNm/m]	X [m]	Y [m]	Z [m]	Richting	dL [m]
2	Global	0	0	-221,00	0	0,071	0,066	0	(0,055; 0,066; 0,000)	0
		0	0	-221,00	0	0,071	0,066	0	-	0,101
3	Global	0	0	-131,00	0	0,063	-0,432	0	(0,050; -0,432; 0,000)	0
		0	0	-131,00	0	0,063	-0,432	0	-	0,082

p_x , p_y , p_z : Belastingkracht component; **p_m :** Belastingmoment component; **X:** Belasting in X-richting; **Y:** Belasting in Y-richting; **Z:** Belasting in Z-richting;

Gebruiker gedefinieerde belastingcombinaties uit belastinggevallen

	Naam	Type	F_x	F_{y1}	F_{y2}	F_z	Commentaar
1	Co #1	UGT	1,00	1,00	0	1,00	
2	Co #2	UGT	1,00	0	1,00	1,00	

Naam: Naam belastingcombinatie; **Type:** Type belastingcombinatie; **F_x , F_{y1} , F_{y2} , F_z :** Factor;

Project:

Constructeur: DNV GL - Energy

Model: **Model 1.axs**

21-2-2021

Pag. 15

Lineaire berekening
Norm Eurocode-NL
Geval : Co #1
E (P) : 7,08E-9
E (W) : 7,08E-9
E (Eq) : 1,32E-10
Comp. : SVM T [N/mm ²]

SVM T [N/mm ²]
268,35
249,26
230,16
211,07
191,97
172,87
153,78
134,68
115,59
96,49
77,40
58,30
39,20
20,11
1,01

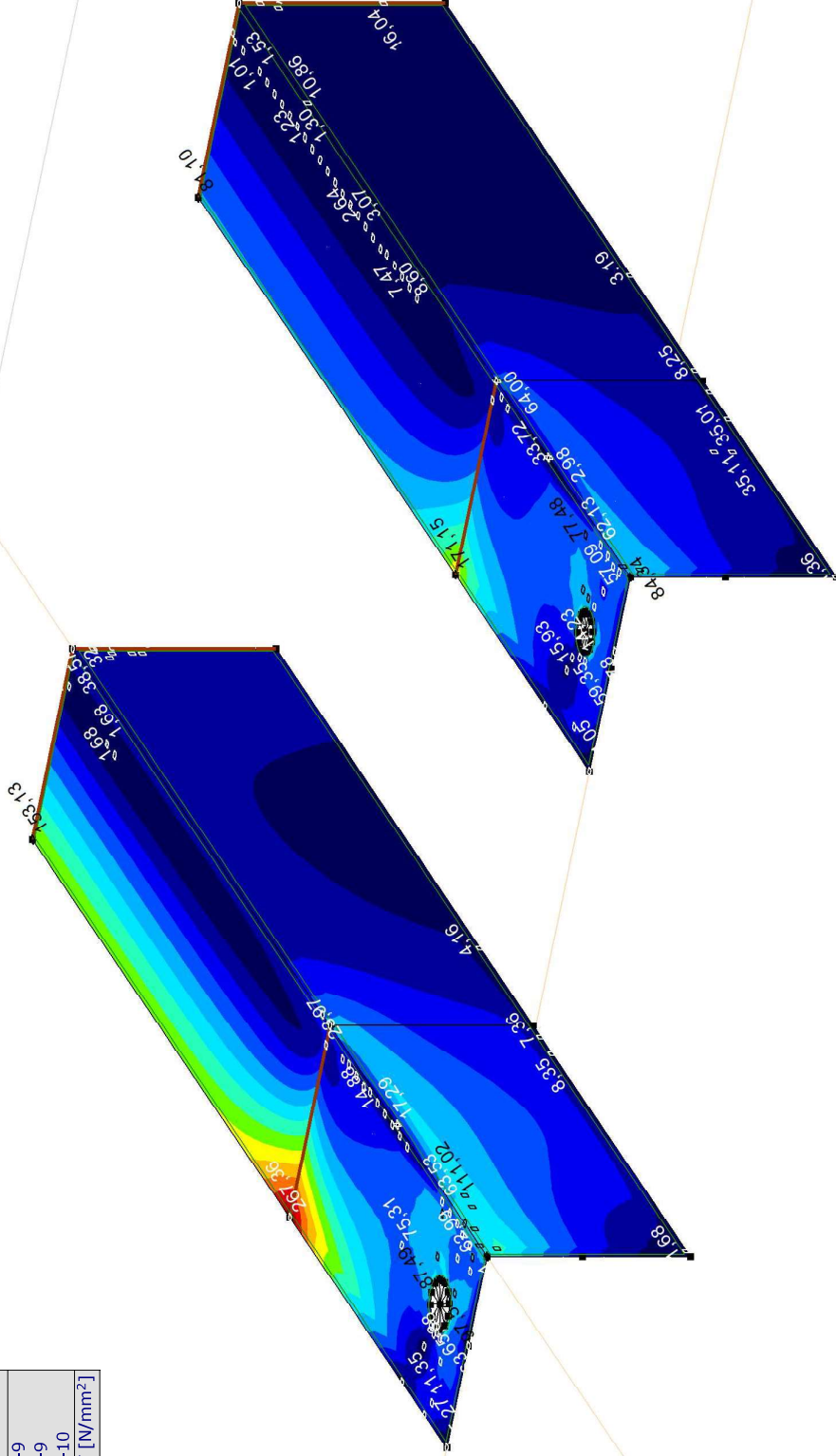

[I]. Lineair, Co #1 (UGT), SVM T, Kleuren 2D

Project:

Constructeur: DNV GL - Energy

Model: Model 1.axis

21-2-2021

Pag. 16

Lineaire berekening
Norm Eurocode-NL
Geval : Co #2
E (P) : 7,08E-9
E (W) : 7,08E-9
E (Eq) : 1,32E-10
Comp. : SVM T [N/mm ²]

SVM T [N/mm ²]
219,10
203,50
187,90
172,30
156,70
141,10
125,50
109,90
94,30
78,70
63,10
47,49
31,89
16,29
0,69

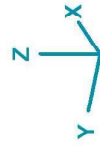
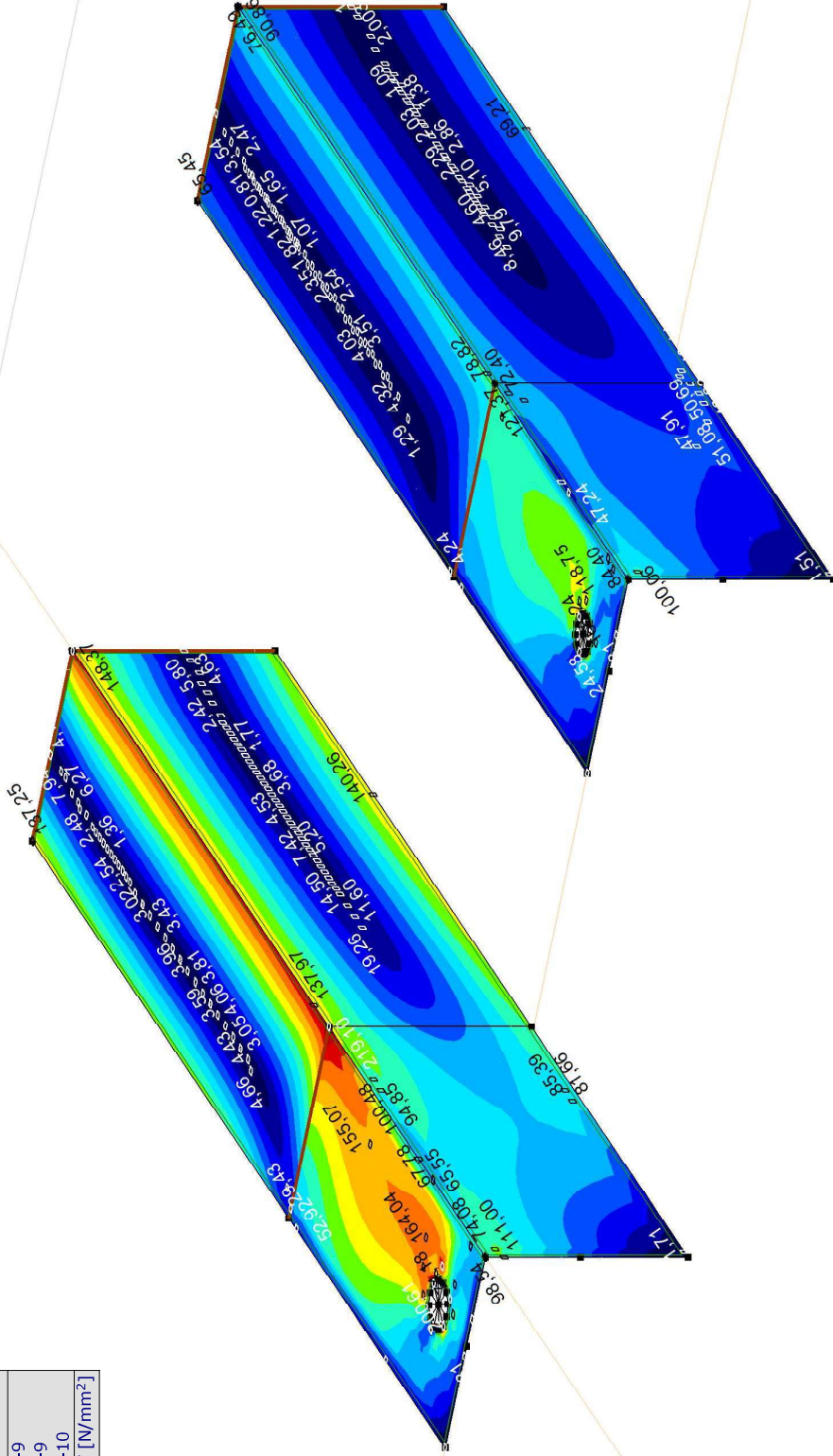

[1]. Lineair, Co #2 (UGT), SVM T, Kleuren 2D

Project:
 Constructeur: DNV GL - Energy
 Model: **Model 1.axs**

21-2-2021

Pag. 17

Lineaire berekening
Norm Eurocode-NL
Geval : Co #1
E (P) : 7,08E-9
E (W) : 7,08E-9
E (Eq) : 1,32E-10
Comp. : SVM C [N/mm ²]

SVM C [N/mm ²]
197,50
183,41
169,32
155,23
141,15
127,06
112,97
98,88
84,79
70,71
56,62
42,53
28,44
14,36
0,27

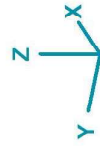
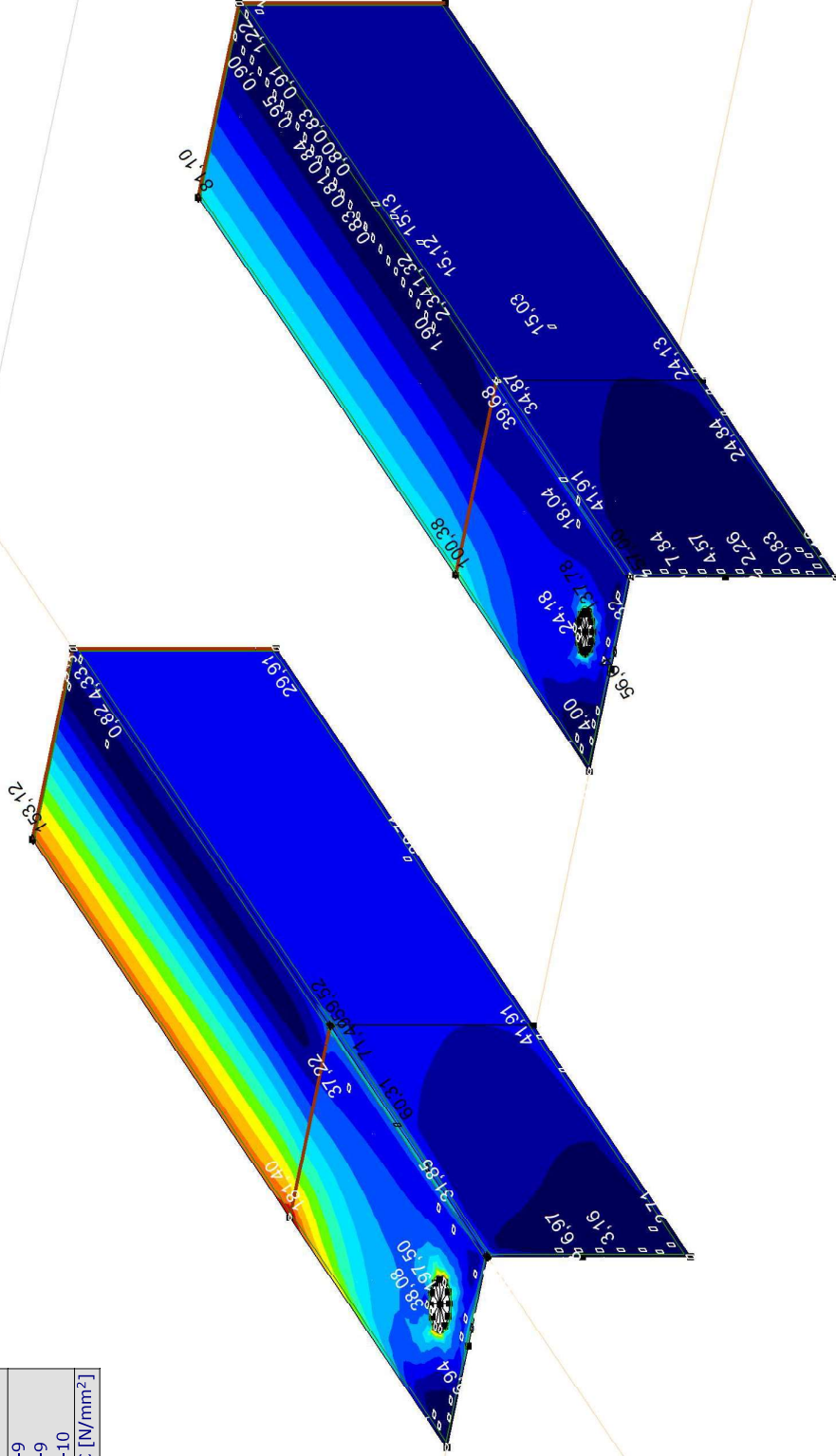

III. Lineair, Co #1 (UGT), SVM C, Kleuren 2D

Project:

Constructeur: DNV GL - Energy

Model: Model 1.axs

21-2-2021

Pag. 18

Lineaire berekening
Norm Eurocode-NL
Geval : Co #2
E (P) : 7,08E-9
E (W) : 7,08E-9
E (Eq) : 1,32E-10
Comp. : SVM C [N/mm ²]

SVM C [N/mm ²]
192,93
179,17
165,42
151,66
137,90
124,14
110,38
96,62
82,86
69,10
55,35
41,59
27,83
14,07
0,31

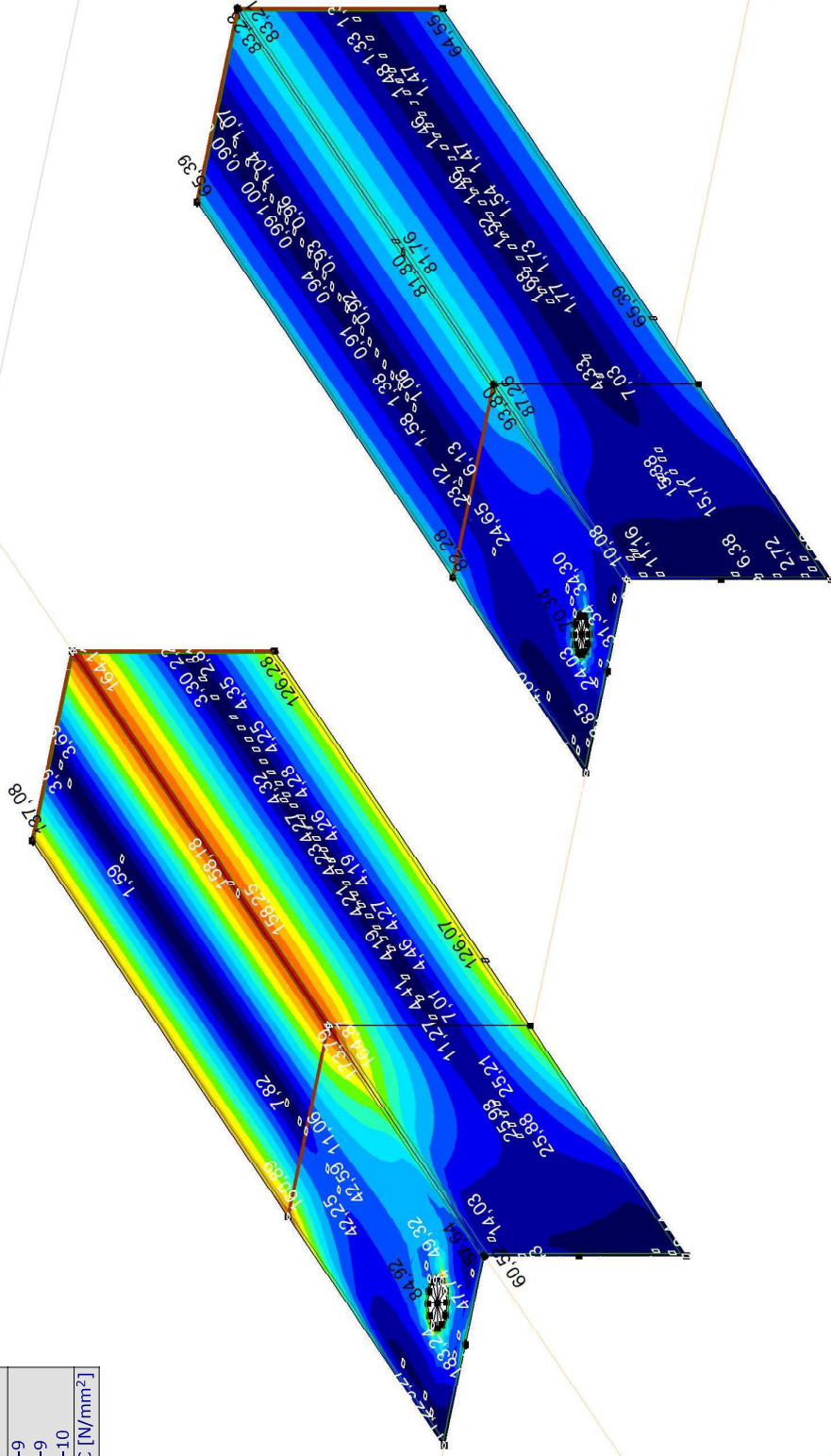

III. Lineair, Co #2 (UGT), SVM C, Kleuren 2D

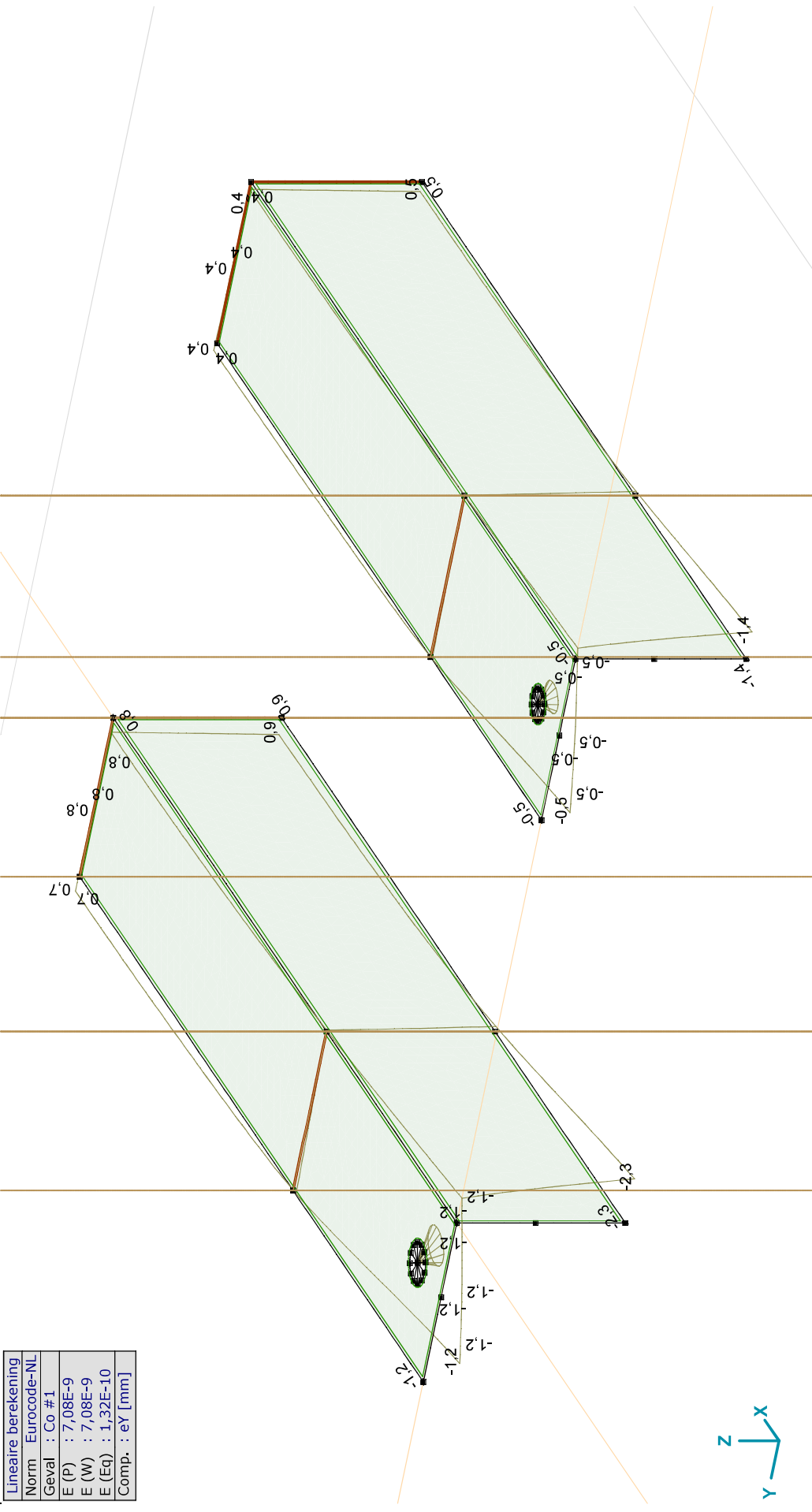

Lineaire berekening	
Norm	Eurocode-NL
Geval	: Co #1
E (P)	: 7,08E-9
E (W)	: 7,08E-9
E (Eq)	: 1,32E-10
Comp.	: eY [mm]

[[J. Lineair, Co #1 (UGT), eY, Lijnen

Project:

Constructeur: DNV GL - Energy

Model: **Model 1.axis**

21-2-2021

Pag. 20

Lineaire berekening
Norm Eurocode-NL
Geval : Co #2
E (P) : 7,08E-9
E (W) : 7,08E-9
E (Eq) : 1,32E-10
Comp. : eY [mm]

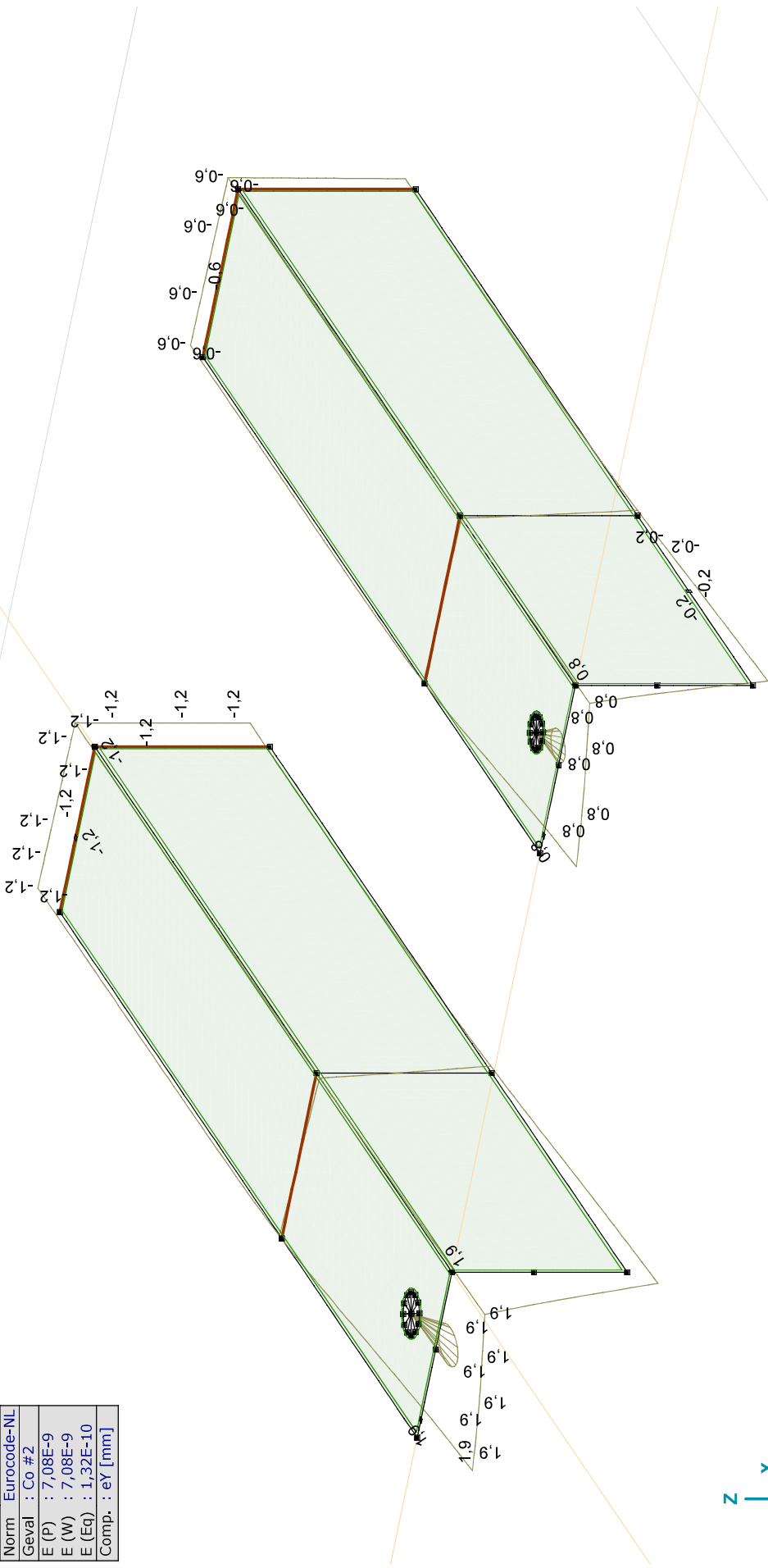

[1]. Lineair, Co #2 (UGT), eY, Lijnen

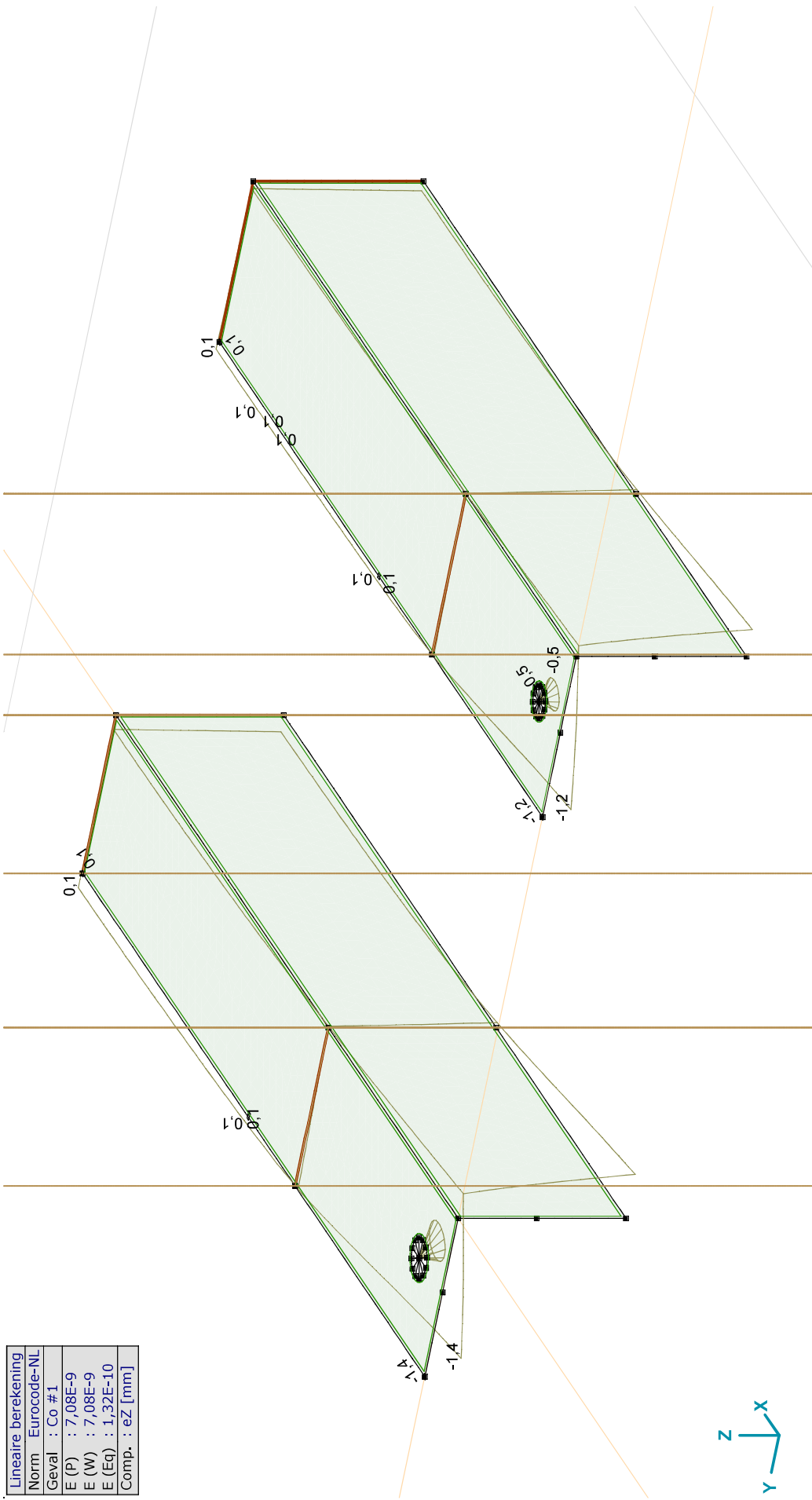

[[J. Linear, Co #1 (UGT), eZ, Lijnen

Lineaire berekening
Norm Eurocode-NL
Geval : Co #1
E (P) : 7,08E-9
E (W) : 7,08E-9
E (Eq) : 1,32E-10
Comp. : eZ [mm]

Project:

Constructeur: DNV GL - Energy

Model: **Model 1.axs**

21-2-2021

Pag. 22

Lineaire berekening	
Norm	Eurocode-NL
Geval	: Co #2
E (P)	: 7,08E-9
E (W)	: 7,08E-9
E (Eq)	: 1,32E-10
Comp.	: eZ [mm]

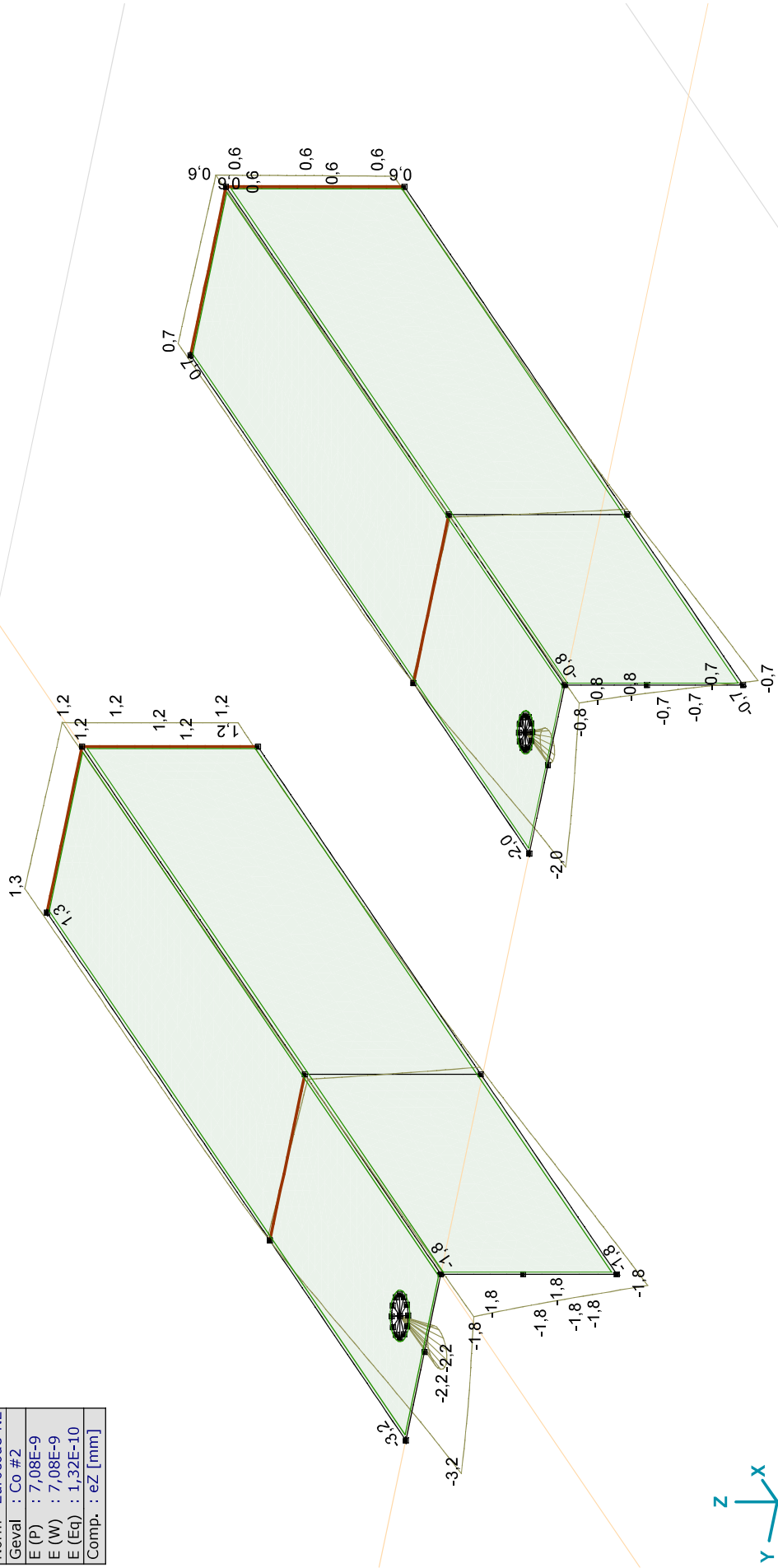

[1]. Lineair, Co #2 (UGT), eZ, Lijnen

Project:
 Constructeur: DNV GL - Energy
 Model: Model 1.axs

21-2-2021

Pag. 23

Lineaire berekening
Norm Eurocode-NL
Geval : Co #1
E (P) : 7,08E-9
E (W) : 7,08E-9
E (Eq) : 1,32E-10
Comp. : Ry [kN/m]

Ry [kN/m]	0
	-28,5
	-57,0
	-85,4
	-113,9
	-142,4
	-170,9
	-199,4
	-227,9
	-256,4
	-284,8
	-313,3
	-341,8
	-370,3
	-398,8

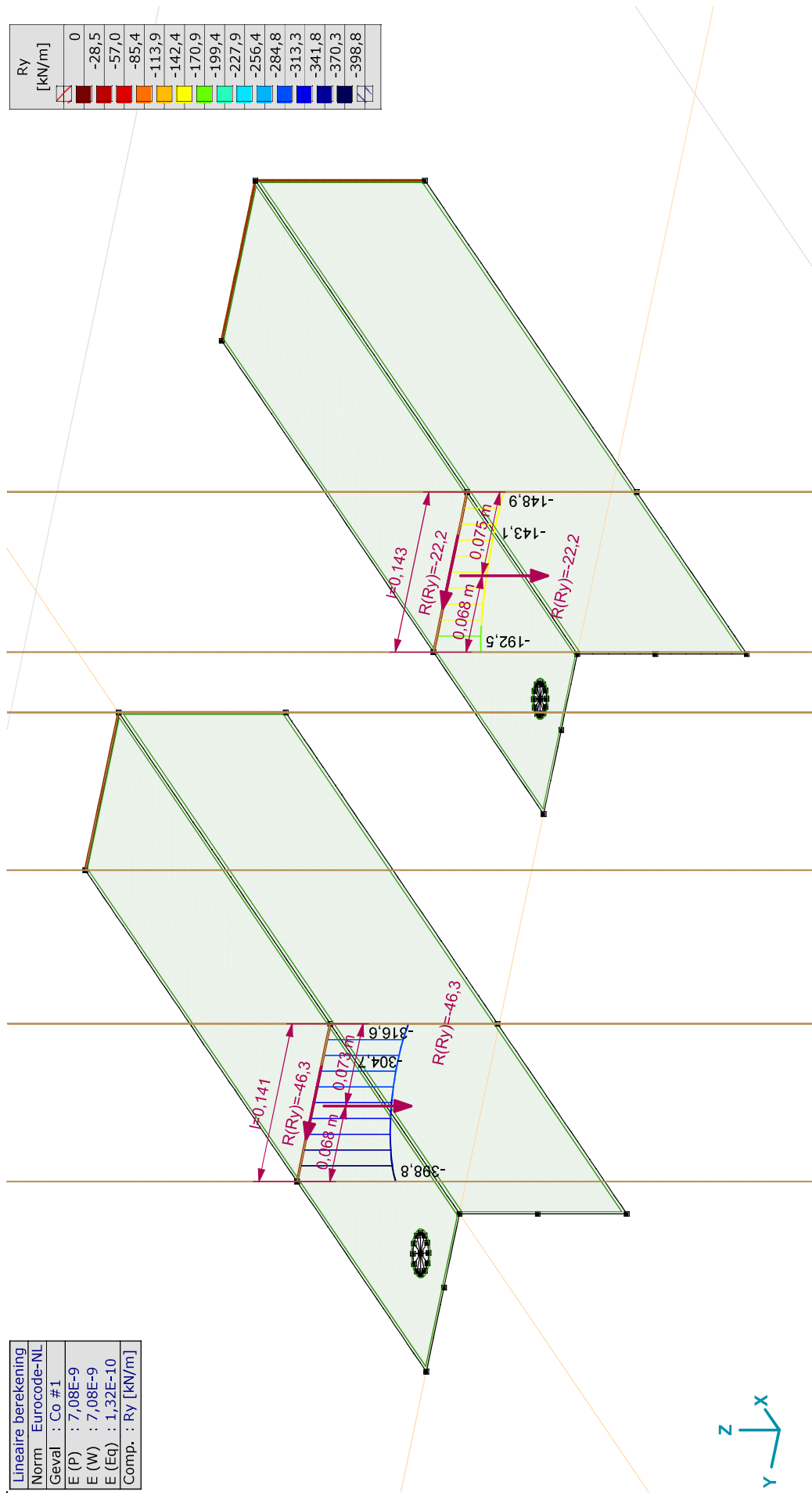

III. Lineair, Co #1 (UGT), Ry (lijnopp.), Doorsnedelij



Project:

Constructeur: DNV GL - Energy

Model: **Model 1.axis**

21-2-2021

Pag. 24

Lineaire berekening	
Norm	Eurocode-NL
Geval	: Co #2
E (P)	: 7,08E-9
E (W)	: 7,08E-9
E (Eq)	: 1,32E-10
Comp.	: Ry [kN/m]

Ry [kN/m]	
386,6	
359,0	
331,4	
303,7	
276,1	
248,5	
220,9	
193,3	
165,7	
138,1	
110,5	
82,8	
55,2	
27,6	
0	

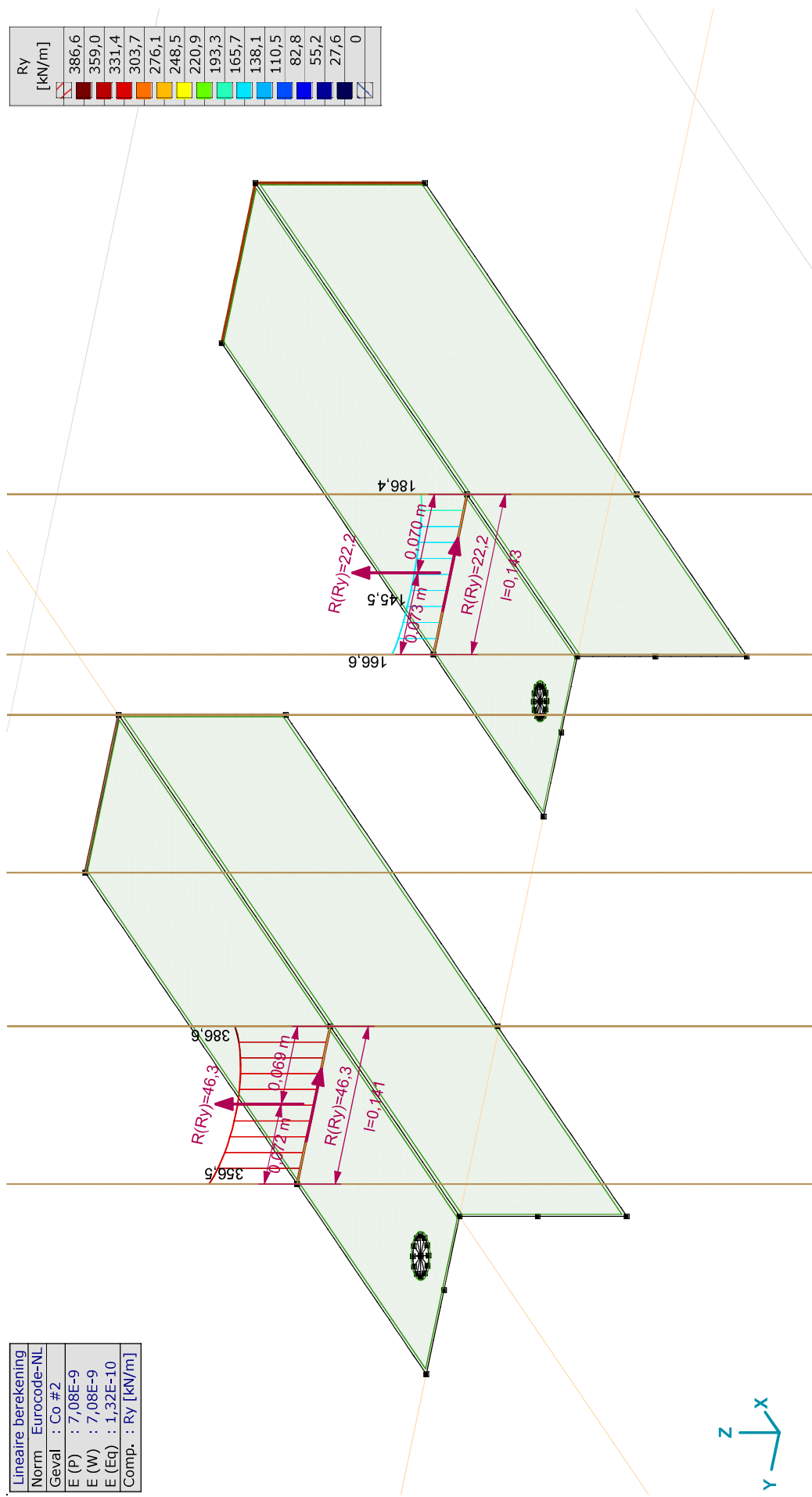

III. Lineair, Co #2 (UGT), Ry (lijnopp.), Doorsnedelij

Project:

Constructeur: DNV GL - Energy

Model: **Model 1.axis**

21-2-2021

Pag. 25

Lineaire berekening
Norm Eurocode-NL
Geval : Co #1
E (P) : 7,08E-9
E (W) : 7,08E-9
E (Eq) : 1,32E-10
Comp. : Rz [kN/m]

Rz [kN/m]	0
	-13,5
	-26,9
	-40,4
	-53,9
	-67,3
	-80,8
	-94,3
	-107,7
	-121,2
	-134,7
	-148,1
	-161,6
	-175,1
	-188,6

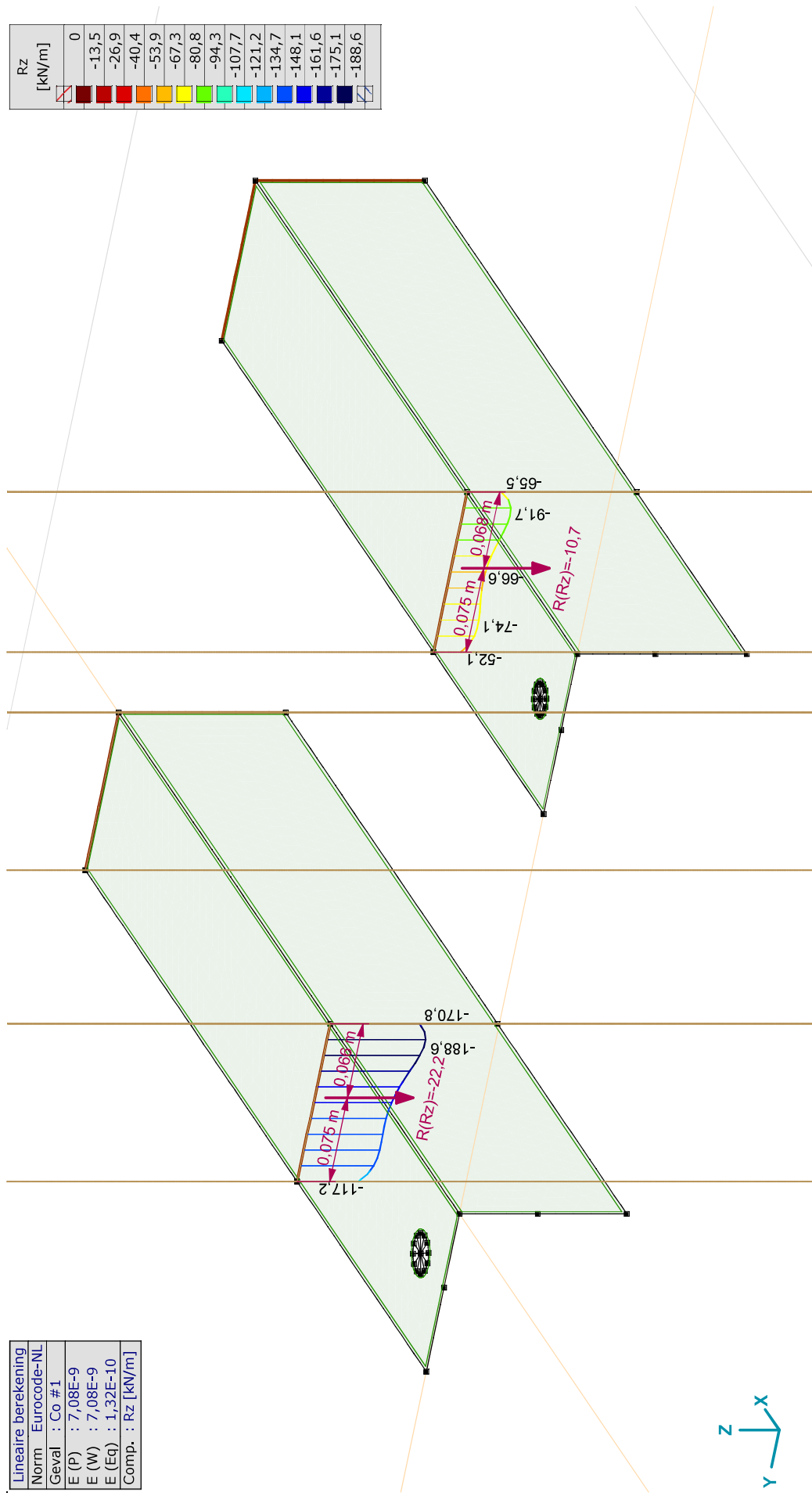

III. Lineair, Co #1 (UGT), Rz (lijnopp.), DoorsnedeIijn



Project:

Constructeur: DNV GL - Energy

Model: **Model 1.axs**

21-2-2021

Pag. 26

Lineaire berekening
Norm Eurocode-NL
Geval : Co #2
E (P) : 7,08E-9
E (W) : 7,08E-9
E (Eq) : 1,32E-10
Comp. : Rz [kN/m]

Rz [kN/m]	0
	-13,0
	-26,0
	-39,1
	-52,1
	-65,1
	-78,1
	-91,1
	-104,1
	-117,2
	-130,2
	-143,2
	-156,2
	-169,2
	-182,3

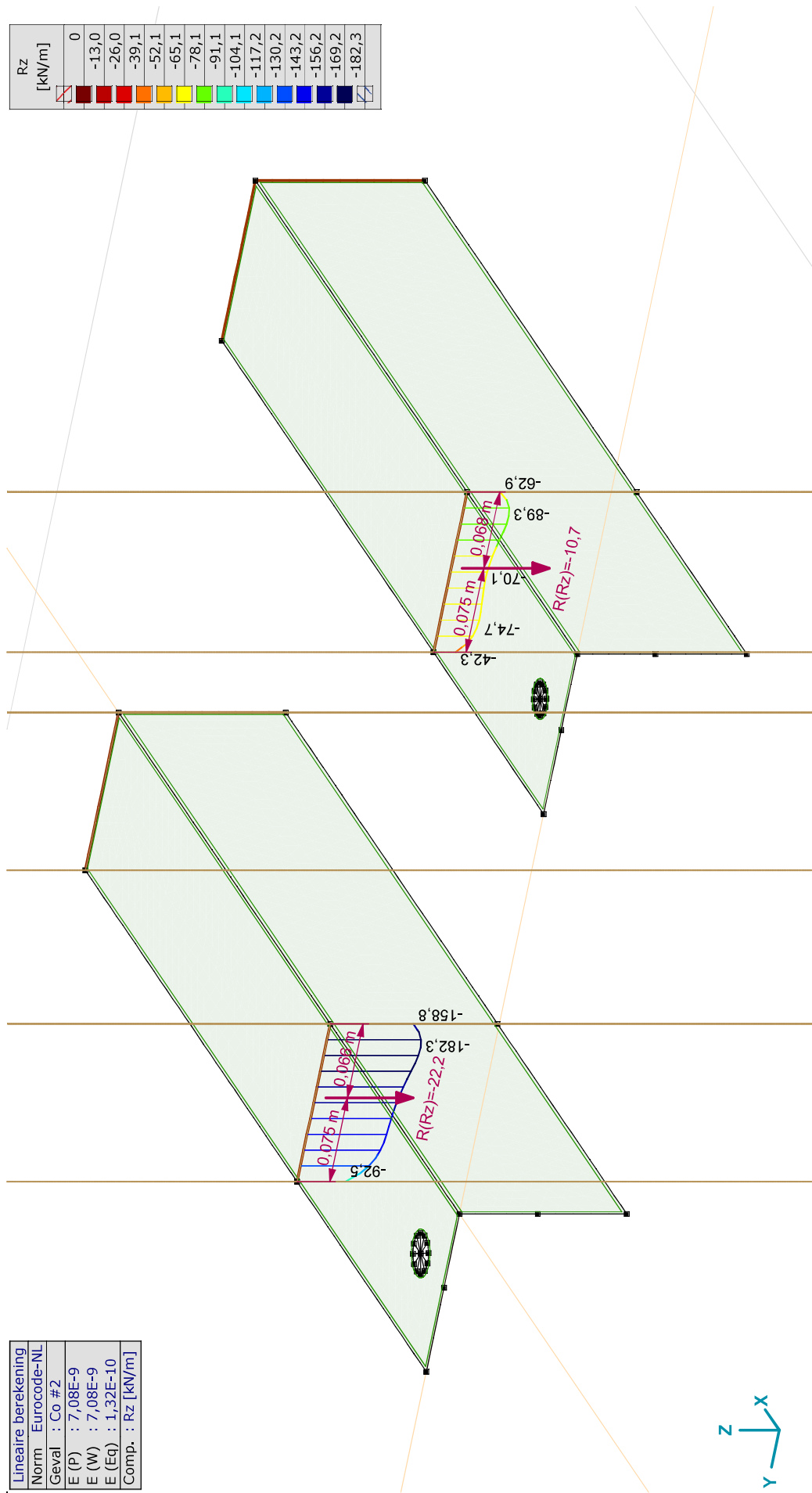

III. Lineair, Co #2 (UGT), Rz (lijnopp.), Doorsnedelij

Project:

Constructeur: DNV GL - Energy

AxisVM X5 R4h • Geregistreerd aan DNV GL - Energy
Post aan onderstrand.axs

Rapport

Rapport, Inhoudsopgave

	Onderdeel	Pagina	Onderdeel	Pagina
	Materialen	3	[I], Lineair, Omhullende (Alle UGT), Tx, Lijnen (gevuld)	18
	Knoppen en staven	4	[I], Lineair, Co #1 (UGT), eR, Lijnen	19
	Dikte	5	[I], Lineair, Co #2 (UGT), eR, Lijnen	20
	Profielen	6	[I], Lineair, Co #3 (UGT), eR, Lijnen	21
	Domijnen	7	[I], Lineair, Co #4 (UGT), eR, Lijnen	22
	Knoopopleggingen	7	[I], Lineair, Co #5 (UGT), eR, Lijnen	23
	Mx: Knoopbelastingen	8	[I], Lineair, Co #6 (UGT), eR, Lijnen	24
	Mx	8	[I], Lineair, Co #1 (UGT), SVM T, Kleuren 2D	25
	My: Knoopbelastingen	9	[I], Lineair, Co #2 (UGT), SVM T, Kleuren 2D	26
	My	9	[I], Lineair, Co #3 (UGT), SVM T, Kleuren 2D	27
	Fz: Knoopbelastingen	10	[I], Lineair, Co #4 (UGT), SVM T, Kleuren 2D	28
	Fz	10	[I], Lineair, Co #5 (UGT), SVM T, Kleuren 2D	29
	N: Knoopbelastingen	11	[I], Lineair, Co #6 (UGT), SVM T, Kleuren 2D	30
	N	11	[I], Lineair, Omhullende (Alle UGT), SVM B, Iso vlakken 3D	31
	Gebruiker gedefinieerde belastingcombinaties uit belastinggevallen	12	[I], Lineair, Omhullende (Alle UGT), SVM C, Iso vlakken 3D	32
	[I], Lineair, Omhullende (Alle UGT), Nx, Lijnen (gevuld)	13	[I], Lineair, Omhullende (Alle UGT), SVM T, Iso vlakken 3D	33
	[I], Lineair, Omhullende (Alle UGT), My, Lijnen (gevuld)	14	Vlakspanningen [Lineair, Omhullende (Alle UGT)]	34
	[I], Lineair, Omhullende (Alle UGT), Mz, Lijnen (gevuld)	15	[I], Lineair, Omhullende (Alle UGT), S;x;minmax, Lijnen (gevuld)	35
	[I], Lineair, Omhullende (Alle UGT), Vz, Lijnen (gevuld)	16	Staafspanningen [Lineair, Omhullende (Alle UGT)]	36
	[I], Lineair, Omhullende (Alle UGT), Vy, Lijnen (gevuld)	17	Interne krachten knoopoplegging [Lineair, Omhullende (Alle UGT)]	37

Project:



Constructeur: DNV GL - Energy

Model: **Post aan onderrand.axs**

6-3-2021

Pag. 3

Materialen

Naam	Type	Nationale norm	Materialnorm	Model	E_x [N/mm ²]	E_y [N/mm ²]	ν	α_T [1/°C]	ρ [kg/m ³]	Material kleur	Contour kleur	Structuur	P_1
1	S 355	Staal	Eurocode-NL 10025-2	Lineair	210000	210000	0.30	1,2E-5	7850				f_y [N/mm ²] = 355.00

Naam	f_u [N/mm ²]	f_c [N/mm ²]	f_t [N/mm ²]	f_{ct} [N/mm ²]	f_{ctk} [N/mm ²]	P_2	P_3	P_4	P_5	P_6	P_7	P_8	P_9	P_{10}	P_{11}	P_{12}	P_{13}	P_{14}
1	S 355	f_u [N/mm ²] = 510.00	f_c [N/mm ²] = 510.00	f_t [N/mm ²] = 510.00	f_{ct} [N/mm ²] = 335.00	f_{ctk} [N/mm ²] = 470.00	P_3	P_4	P_5	P_6	P_7	P_8	P_9	P_{10}	P_{11}	P_{12}	P_{13}	P_{14}

Naam: Materiaalnaam; **Type:** Type materiaal; **Model:** Materiaal model; **E_x :** Elasticiteitsmodulus in lokale x richting; **E_y :** Elasticiteitsmodulus in lokale y richting; **ν :** Poisson's verhouding; **α_T :** Warmteuitzettingscoëfficiënt; **ρ :** Dichtheid; **Materiaal kleur:** Materiaalkleur; **Contour kleur:** $P_1, P_2, P_3, P_4, P_5, P_6, P_7, P_8, P_9, P_{10}, P_{11}, P_{12}, P_{13}, P_{14}$: Ontwerpparameter;

Project:
Constructeur: DNV GL - Energy
Model: **Post aan onderrand.axs**

Norm Eurocode-NL
Geval : Fz

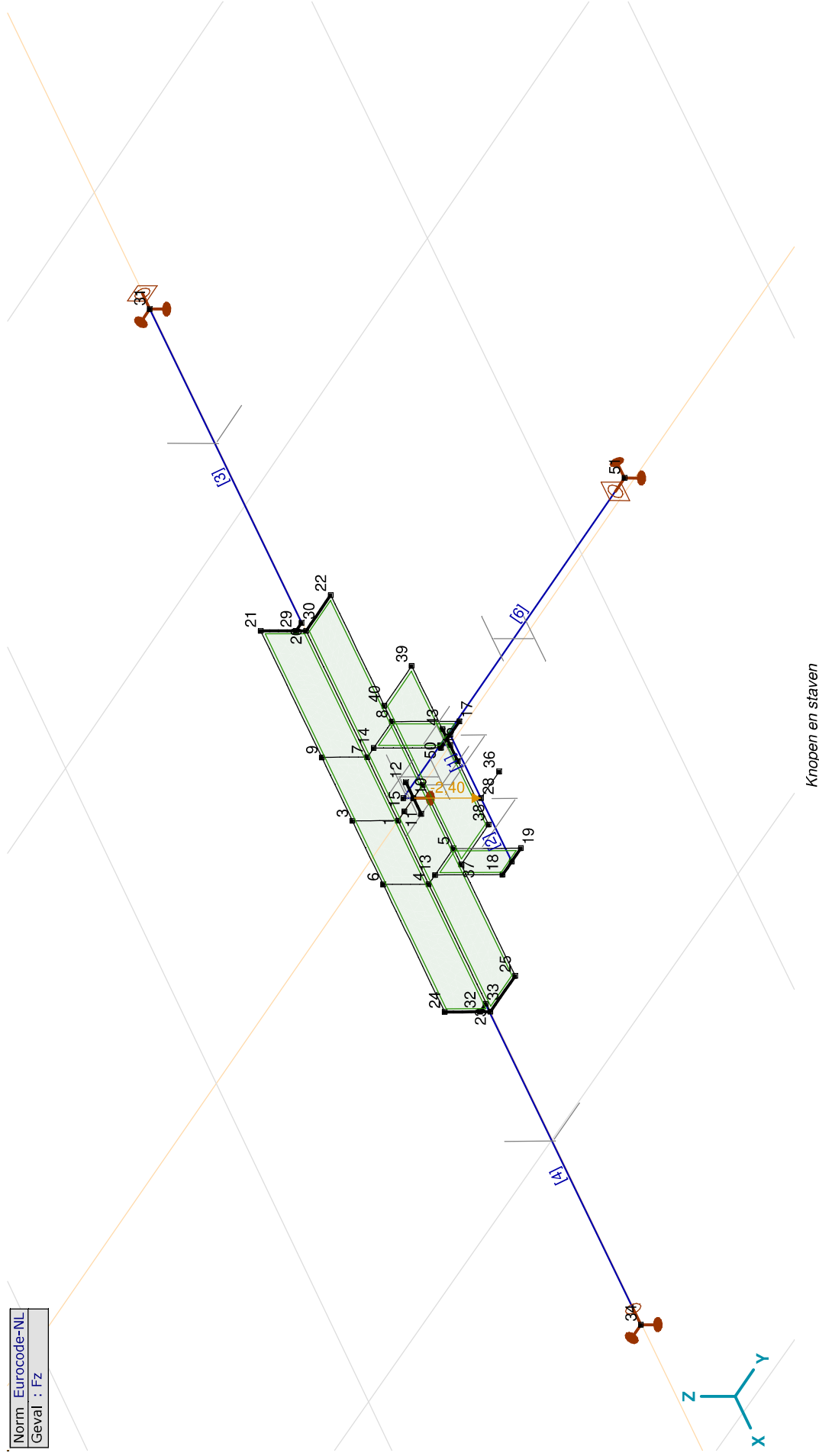

Project:

Constructeur: DNV GL - Energy
Model: Post aan onderstrand.axs

Norm Eurocode-NL
Geval : N

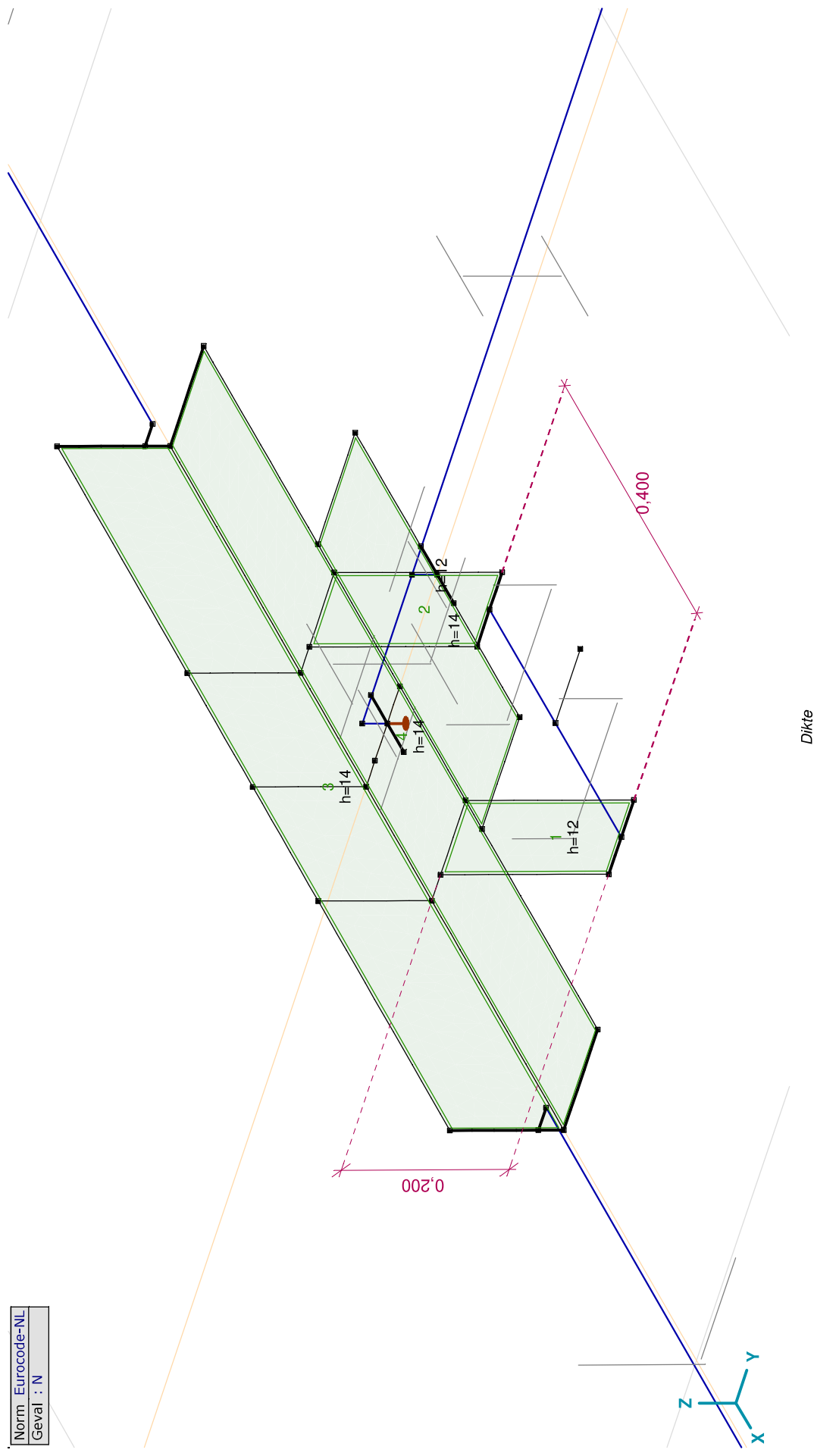



Project:

Constructeur: DNV GL - Energy
 Model: Post aan onderrand.axs

6-3-2021

Pag. 6

Profielen

Naam	Tekening	Productie	Vorm	h [mm]	b [mm]	tw [mm]	tf [mm]	r ₁ [mm]	r ₂ [mm]	r ₃ [mm]	A _x [mm ²]	A _y [mm ²]	A _z [mm ²]	I _x [mm ⁴]	I _y [mm ⁴]	I _z [mm ⁴]
1 U 200		Gewalst	U	200,0	75,0	8,5	11,5	11,5	6,0	0	3218,52	931,26	1555,63	121078,6	1,9E+07	1477534,0
2 L 150X150X14		Gewalst	L	150,0	150,0	14,0	14,0	16,0	8,0	0	4031,60	1760,18	1776,16	278959,0	8453331,0	8453331,0
3 HE 140 A		Gewalst	I	133,0	140,0	5,5	8,5	12,0	0	0	3142,19	2147,66	704,86	81932,8	1E+07	3893251,0

Naam	I _{yz} [mm ⁴]	I ₁ [mm ⁴]	I ₂ [mm ⁴]	α [°]	I _ω [mm ⁶]	W _{1,el,t} [mm ³]	W _{1,el,b} [mm ³]	W _{2,el,t} [mm ³]	W _{2,el,b} [mm ³]	W _{1,pl} [mm ³]	W _{2,pl} [mm ³]	i _y [mm]	i _z [mm]	H _y [mm]	H _z [mm]
1 U 200	0	1,9E+07	1477534,0	0	8,9E+09	191091,8	191091,8	26935,4	73344,2	227755,3	51850,6	77,1	21,4	75,0	200,0
2 L 150X150X14	-4971153,0	1,3E+07	3482178,0	45,00	4,2E+08	126567,2	126567,2	65498,4	58536,3	200109,5	102485,0	45,8	45,8	150,0	150,0
3 HE 140 A	0	1E+07	3893251,0	0	1,5E+10	155382,8	155382,8	55617,9	55617,9	173525,9	84852,6	57,3	35,2	140,0	133,0

Naam	y _G [mm]	z _G [mm]	y _s [mm]	z _s [mm]	S.p.
1 U 200	20,1	100,0	-38,7	0	8
2 L 150X150X14	42,1	42,1	-33,9	-33,9	4
3 HE 140 A	70,0	66,5	0	0	9

Naam: Doorsnede naam; **Productieproces:** Vorm; **Profiel:** h: Doorsnede hoogte; b: Doorsnede breedte; tw: Lijfdikte; tf: Flensdikte; r₁, r₂, r₃: Afrondingswaarde; **Ax:** Doorsnede-oppervlak; **Ay:** Afschuiwingsoppervlak; **Ix:** Torsieaagheidsmoment; **Iy, Iz:** Buijgraagheidsmoment; **Iyz:** Centrifugaal traagheidsmoment; **I₁, I₂:** Hoofdbuigtraagheidsmoment; **α:** Hoofdrichtingen; **I_ω:** Krommingsconstante; **W_{1,el}, W_{2,el}, W_{1,pl}, W_{2,pl}:** Elasticiteit modulus; **i_y, i_z:** Traagheidsstraal; **H_y:** Afmeting in lokale Y-richting; **H_z:** Afmeting in lokale Z-richting; **y_s:** Y-coördinaat van het zwaartepunt; **y_G:** Z-coördinaat van het afschuiwingsmiddelpunt (torsie); **z_s:** Z-coördinaat van het afschuiwingsmiddelpunt (torsie); **S.p.:** Spanningspunten;

Project:

Constructeur: DNV GL - Energy
 Model: Post aan onderrand.axs

Domeinen

Element type	Materiaal	Ref _x	Ref _z	Dikte [mm]	k _{buiging} []	k _{torsie} []	k _{afschuiving} []	Oppervlakte [m ²]	Gat	Mesh
1	Schaal S 355	Auto	Auto	12				0,020	-	✓
2	Schaal S 355	Auto	Auto	12				0,020	-	✓
3	Schaal S 355	Auto	Auto	14				0,162	-	✓
4	Schaal S 355	Auto	Auto	14				0,162	-	✓
5	Schaal S 355	Auto	Auto	14				0,075	-	✓

Element type: Plaatslement type; **Ref_x:** Referentie voor lokale X-richting; **Ref_z:** Referentie voor lokale Z-richting; **k_{buiging}:** Buigsterkte coefficient; **k_{torsie}:** Torsiesterkte coefficient; **k_{afschuiving}:** Dwarskrachsterkte coefficient; **Oppervlakte:** Domein oppervlakte;
Gat: Aantal gaten in domein; **Mesh:** Gegeneerde mesh;

Knooppopleggingen

Knoop	X [m]	Y [m]	Z [m]
1	31	-1,600	0,030
2	34	1,600	0,030
3	51	0	1,285
4	10	0	0,085

Knoop	Type	Naam _x	K _x [kN/m]	K _{xv} [kN/m]	Naam _y	K _y [kN/m]	K _{yv} [kN/m]	Naam _z	K _z [kN/m]	K _{zv} [kN/m]	Naam _{xx}	K _{xx} [kNm/rad]	K _{xv} [kNm/rad]
1	31	Glob.	Vast - translatie	1E+10	Vast - translatie	1E+10	1E+10	Vast - translatie	1E+10	1E+10	Vast - rotatie	1E+10	1E+10
2	34	Glob.	—	—	Vast - translatie	1E+10	1E+10	Vast - translatie	1E+10	1E+10	Vast - rotatie	1E+10	1E+10
3	51	Glob.	Vast - translatie	1E+10	Vast - translatie	1E+10	1E+10	Vast - translatie	1E+10	1E+10	—	—	—
4	10	Glob.	—	—	—	—	—	Vast - translatie	1E+10	1E+10	—	—	—

Knoop	Naam _{yy}	K _{yy} [kNm/rad]	K _{yvv} [kNm/rad]	Naam _{zz}	K _{zz} [kNm/rad]	K _{zvv} [kNm/rad]
1	—	—	—	—	—	—
2	—	—	—	—	—	—
3	Vast - rotatie	1E+10	1E+10	—	—	—
4	—	—	—	—	—	—

Knoop: Ondersteunde knoop; **Type:** Opleggingstype; **Naam_x:** Naam van de veereigenschappen; **K_x:** Initiële stijfheid; **K_{xv}:** Trillingsstijfheid; **Naam_y:** Naam van de veereigenschappen; **K_y:** Initiële stijfheid; **K_{yv}:** Trillingsstijfheid; **Naam_z:** Naam van de veereigenschappen; **K_z:** Initiële stijfheid; **K_{zv}:** Trillingsstijfheid; **Naam_{xx}:** Naam van de veereigenschappen; **K_{xx}:** Initiële stijfheid; **K_{xv}:** Trillingsstijfheid; **Naam_{yy}:** Naam van de veereigenschappen; **K_{yy}:** Initiële stijfheid; **K_{yvv}:** Trillingsstijfheid; **Naam_{zz}:** Naam van de veereigenschappen; **K_{zz}:** Initiële stijfheid; **K_{zvv}:** Trillingsstijfheid;

Project:
 Constructeur: DNV GL - Energy
 Model: **Post aan onderrand.axs**

Mx: Knooppbelastingen

Richting	F_x [kN]	F_y [kN]	F_z [kN]	M_x [kNm]	M_y [kNm]	M_z [kNm]
28 Globaal	0	1,80	0	2,40	0	0

F_x, F_y, F_z : Belastingkracht component; M_x, M_y, M_z : Belastingmoment component;

Norm Eurocode-NL
 Geval : Mx

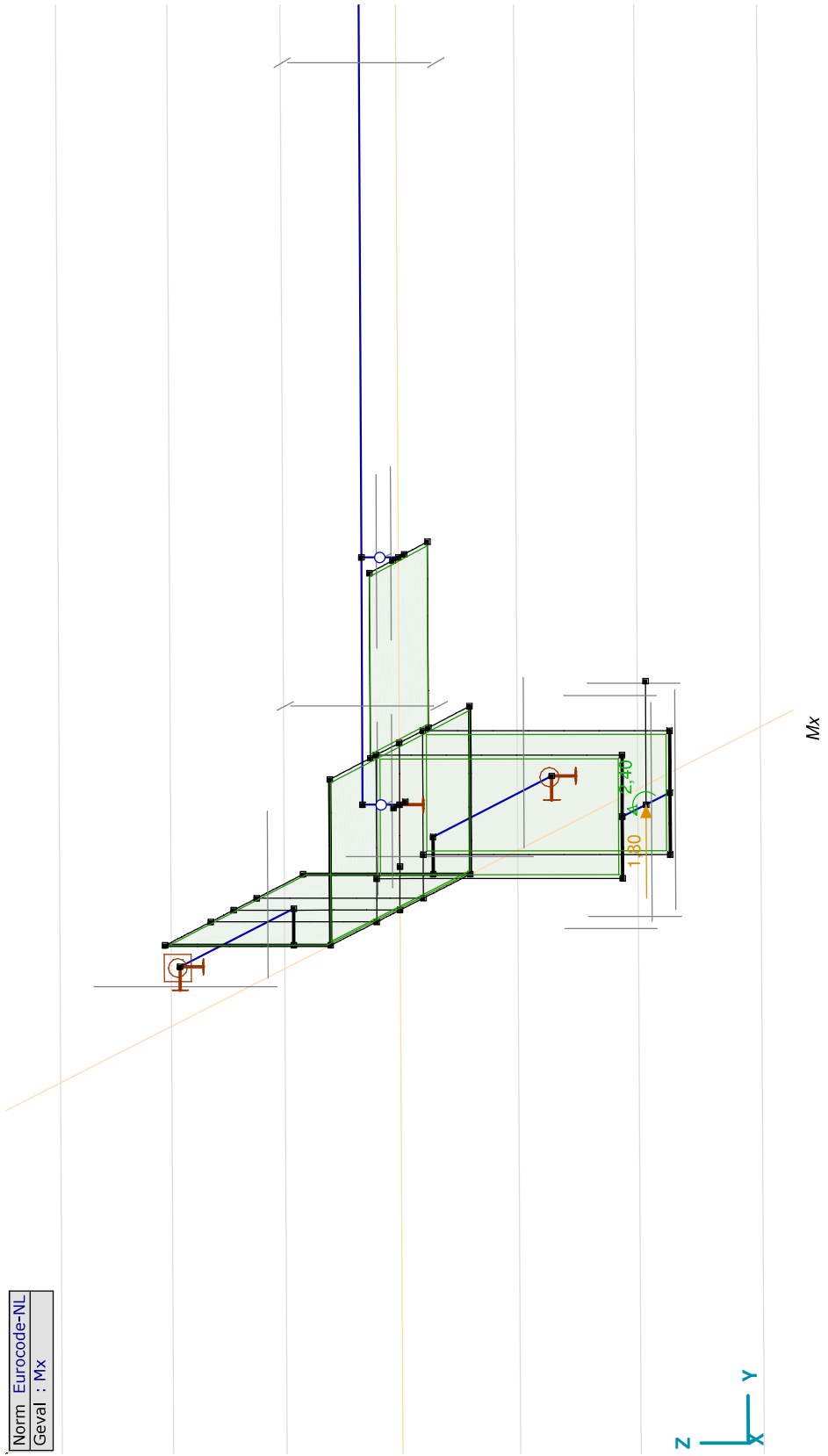

Project:
 Constructeur: DNV GL - Energy
 Model: Post aan onderrand.axs

My: Knoopbelastingen

	Richting	F_x [kN]	F_y [kN]	F_z [kN]	M_x [kNm]	M_y [kNm]	M_z [kNm]
28	Global	-3,00	0	0	0	5,80	0

F_x, F_y, F_z : Belastingkracht component: M_x, M_y, M_z : Belastingmoment component:

Norm Eurocode-NL
 Geval : My

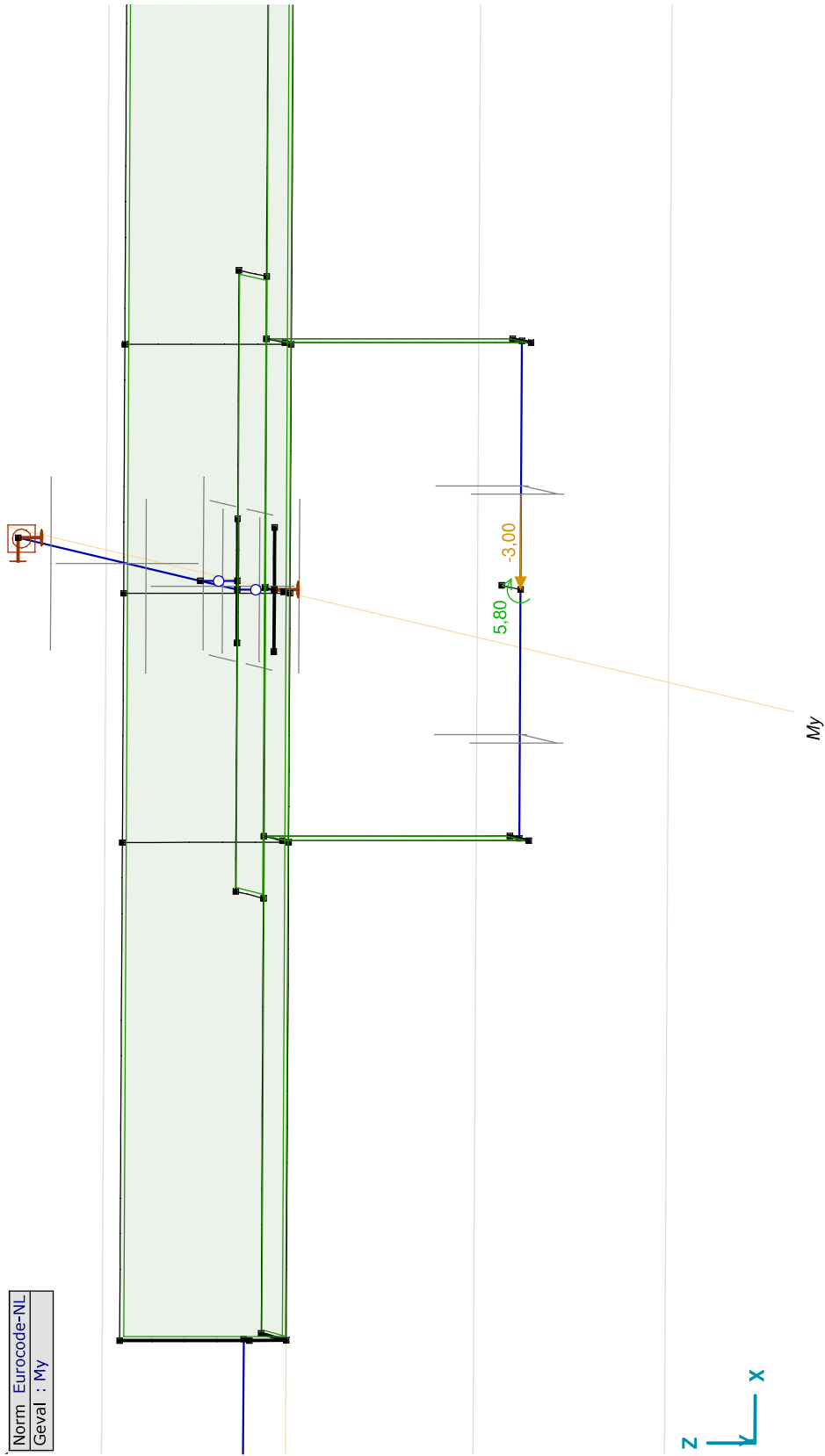

Project:
 Constructeur: DNV GL - Energy
 Model: Post aan onderrand.axs

Fz: Knoopbelastingen

Richting	F_x [kN]	F_y [kN]	F_z [kN]	M_x [kNm]	M_y [kNm]	M_z [kNm]
28 Globaal	0	0	-2,40	0	0	0

Fx, Fy, Fz: Belastingkracht component; Mx, My, Mz: Belastingmoment component;

Norm Eurocode-NL
 Geval : Fz

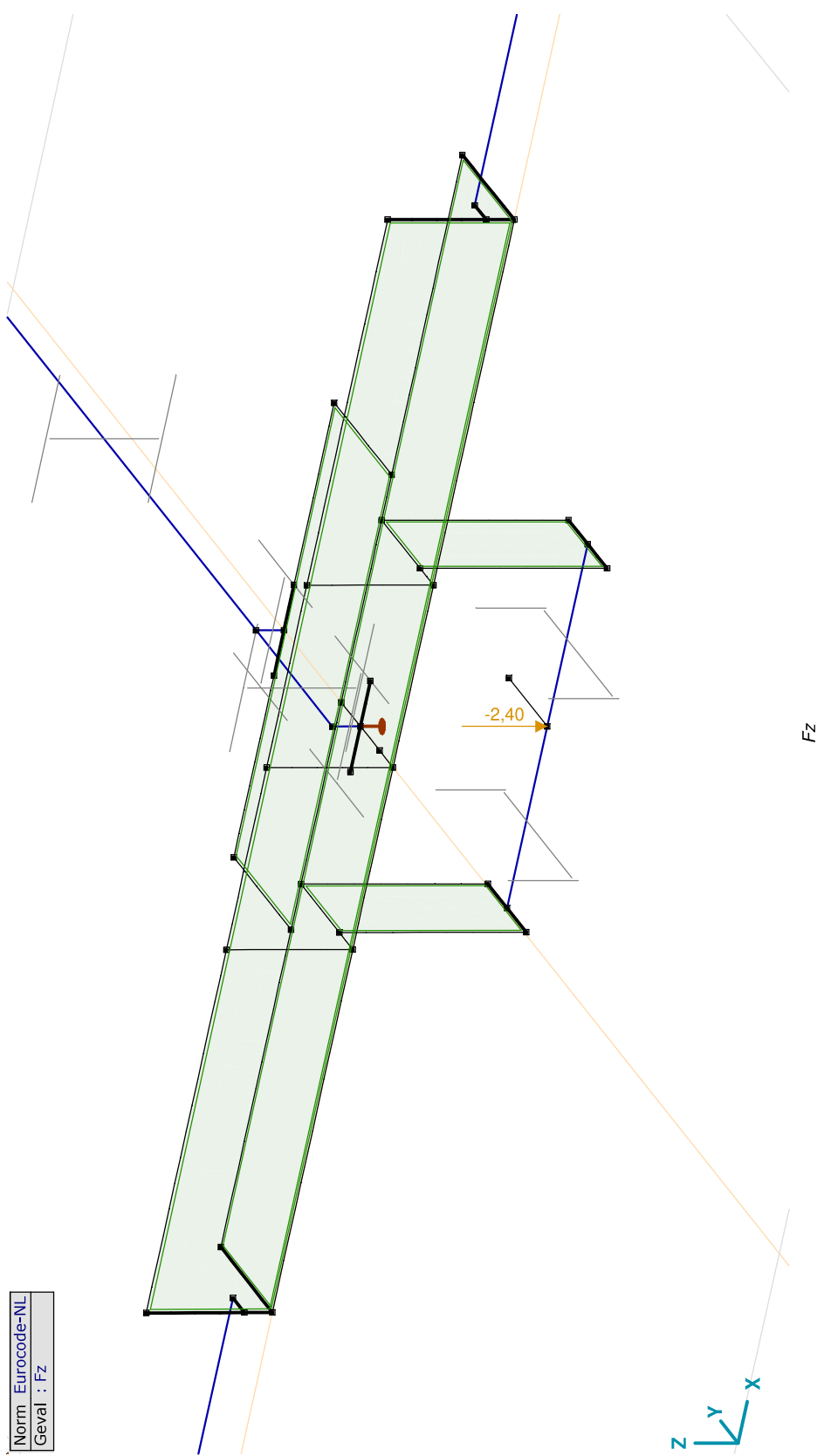

Project:

Constructeur: DNV GL - Energy
 Model: Post aan onderstrand.axs

N: Knooppbelastingen

	Richting	F_x [kN]	F_y [kN]	F_z [kN]	M_x [kNm]	M_y [kNm]	M_z [kNm]
34	Global	-600,00	0	0	0	0	0

F_x, F_y, F_z : Belastingkracht component; M_x, M_y, M_z : Belastingmoment component;

Norm Eurocode-NL
 Geval : N

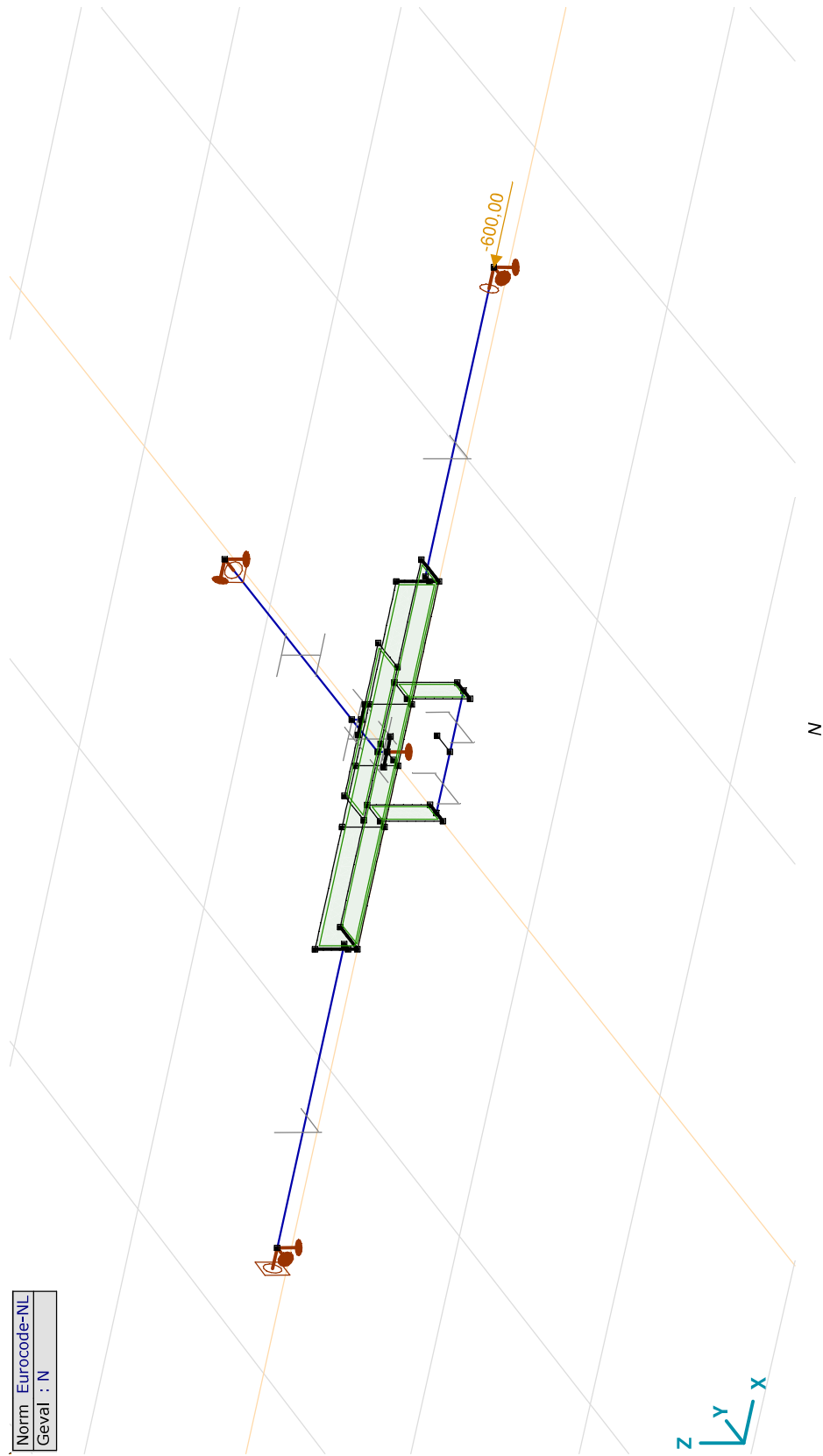

Project:Constructeur: DNV GL - Energy
Model: **Post aan onderrand.axs**

Gebruiker gedefinieerde belastingcombinaties uit belastinggevallen

	<i>Naam</i>	<i>Type</i>	<i>Mx</i>	<i>My</i>	<i>Fz</i>	<i>N</i>	<i>Commentaar</i>
1	Co #1	UGT	1,00	0	1,00	1,00	
2	Co #2	UGT	0	1,00	1,00	1,00	
3	Co #3	UGT	-1,00	0	1,00	1,00	
4	Co #4	UGT	0	-1,00	1,00	1,00	
5	Co #5	UGT	0,71	0,71	1,00	1,00	
6	Co #6	UGT	-0,71	-0,71	1,00	1,00	

Naam: Naam belastingcombinatie; Type: Type belastingcombinatie; Mx, My, Fz, N: Factor;

Project:
 Constructeur: DNV GL - Energy
 Model: Post aan onderstrand.axs

Norm	Lineaire berekening
Geval	Eurocode-NL
Omhullende	: Omhullende Min,Max
E (P)	: Alle UGT
E (W)	: 2,64E-9
E (Eq)	: 2,64E-9
Comp.	: 2,76E-7
	: Nx [kN]

Nx [kN]
13,0
-30,9
-74,9
-118,9
-162,9
-206,9
-250,9
-294,9
-338,9
-382,9
-426,9
-470,9
-514,8
-558,8
-602,8

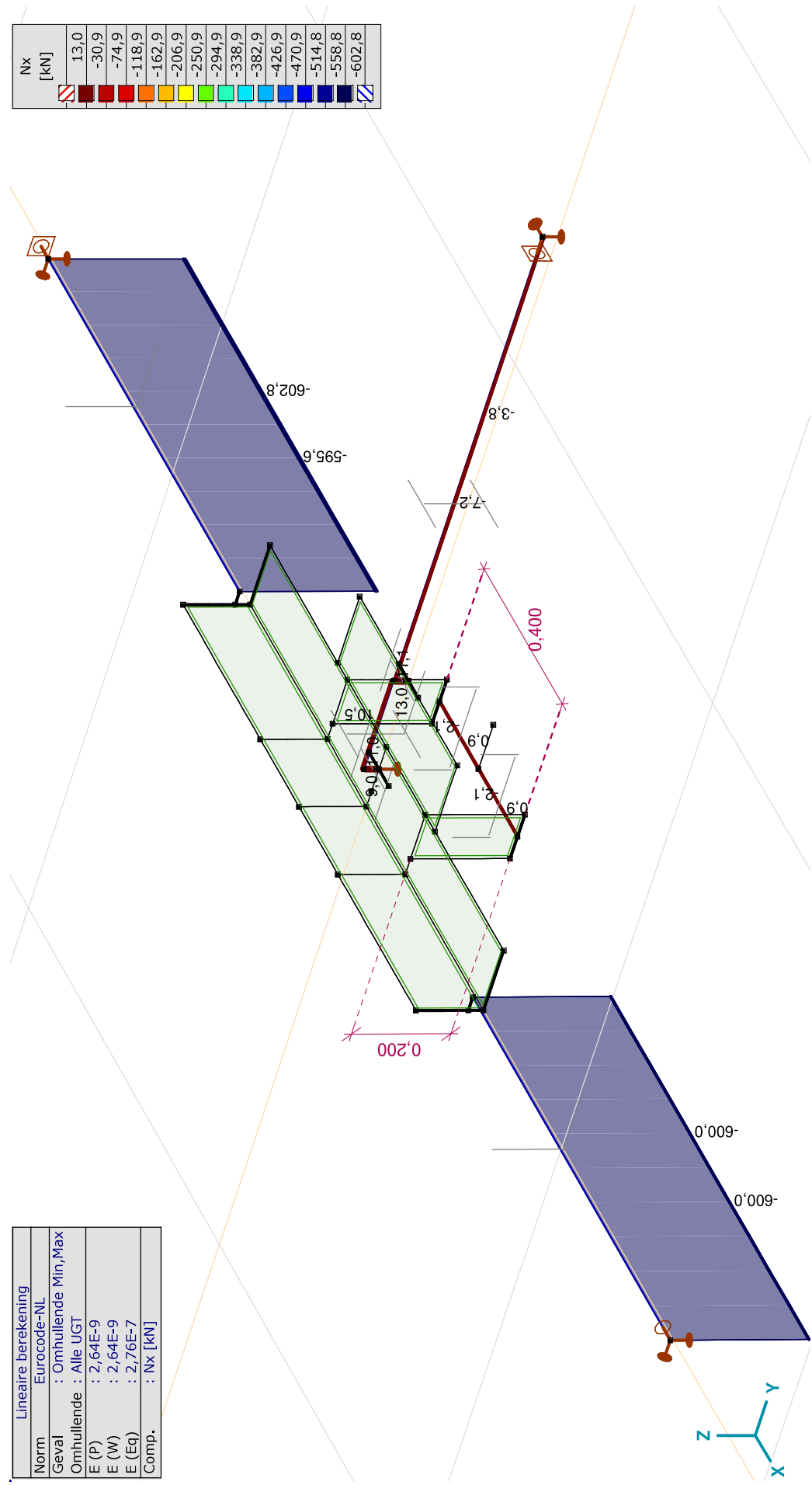

[1], Lineair, Omhullende (Alle UGT), Nx, Lijnen (gevuld)

Project:
 Constructeur: DNV GL - Energy
 Model: Post aan onderstrand.axs

Lineaire berekening	
Norm	Eurocode-NL
Geval	: Omhullende Min,Max
Omhullende	: Alle UGT
E (P)	: 2,64E-9
E (W)	: 2,64E-9
E (Eq)	: 2,76E-7
Comp.	: My [kNm]

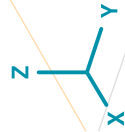
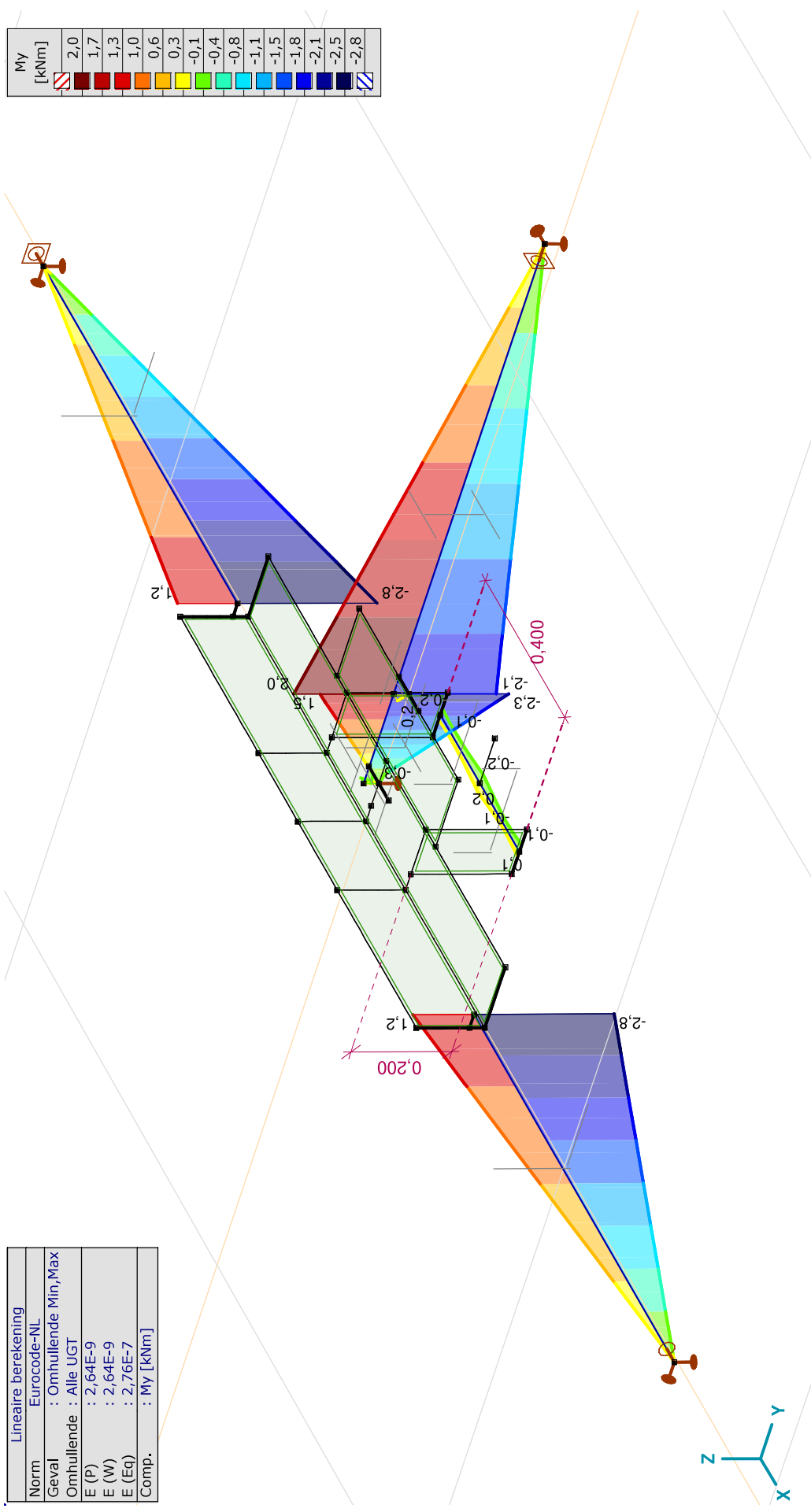
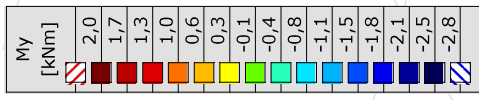

[1], Lineair, Omhullende (Alle UGT), My, Lijnen (gevuld)

Project:
 Constructeur: DNV GL - Energy
 Model: Post aan onderstrand.axs

Lineaire berekening	
Norm	Eurocode-NL
Geval	: Omhullende Min,Max
Omhullende	: Alle UGT
E (P)	: 2,64E-9
E (W)	: 2,64E-9
E (Eq)	: 2,76E-7
Comp.	: Mz [kNm]

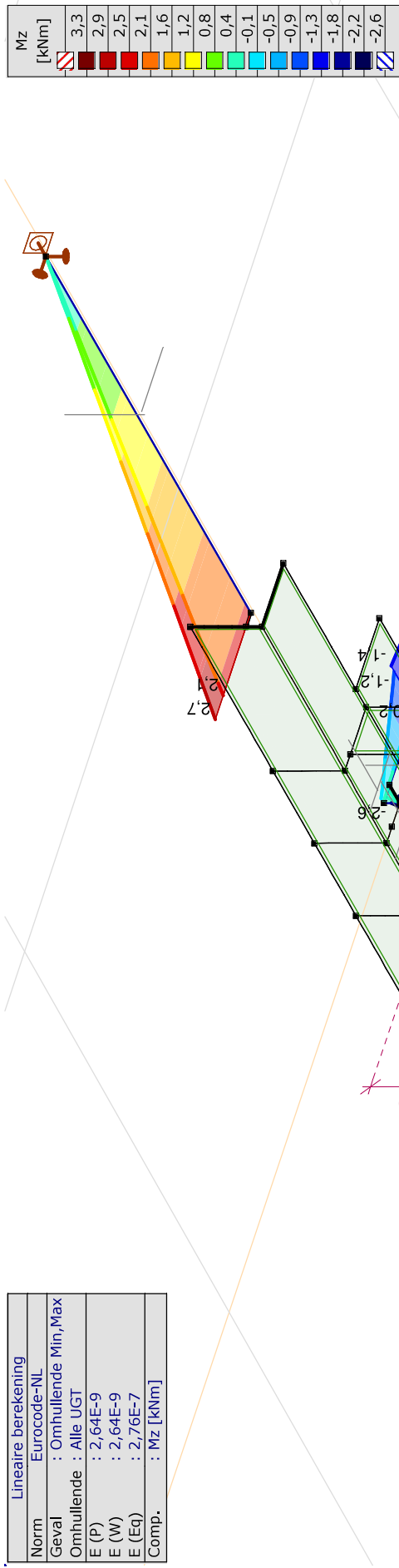

Mz [kNm]
3,3
2,9
2,5
2,1
1,6
1,2
0,8
0,4
-0,1
-0,5
-0,9
-1,3
-1,8
-2,2
-2,6

[1], Lineair, Omhullende (Alle UGT), Mz, Lijnen (gevuld)

Project:
 Constructeur: DNV GL - Energy
 Model: Post aan onderstrand.axs

Lineaire berekening	
Norm	Eurocode-NL
Geval	: Omhullende Min,Max
Omhullende	: Alle UGT
E (P)	: 2,64E-9
E (W)	: 2,64E-9
E (Eq)	: 2,76E-7
Comp.	: Vz [kN]

Vz [kN]
9,0
7,6
6,2
4,8
3,3
1,9
0,5
-1,0
-2,4
-3,8
-5,2
-6,7
-8,1
-9,5
-11,0

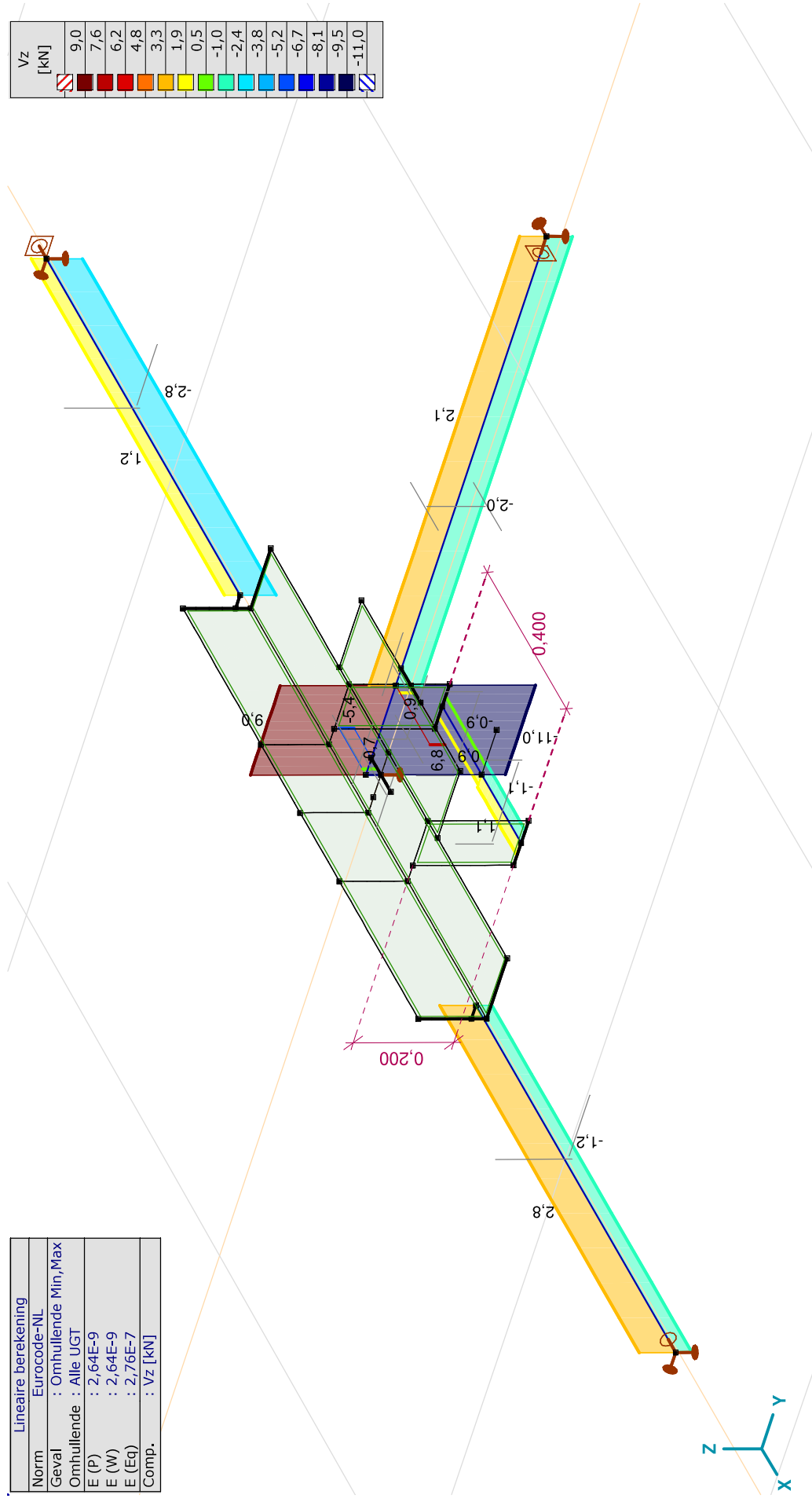

[!] Lineair, Omhullende (Alle UGT), Vz, Lijnen (gevuld)

Project:

Constructeur: DNV GL - Energy
 Model: Post aan onderstrand.axs

Lineaire berekening	
Norm	Eurocode-NL
Geval	: Omhullende Min,Max
Omhullende	: Alle UGT
E (P)	: 2,64E-9
E (W)	: 2,64E-9
E (Eq)	: 2,76E-7
Comp.	: Vy [kN]

Vy [kN]
17,8
15,3
12,9
10,4
8,0
5,6
3,1
0,7
-1,8
-4,2
-6,7
-9,1
-11,5
-14,0
-16,4

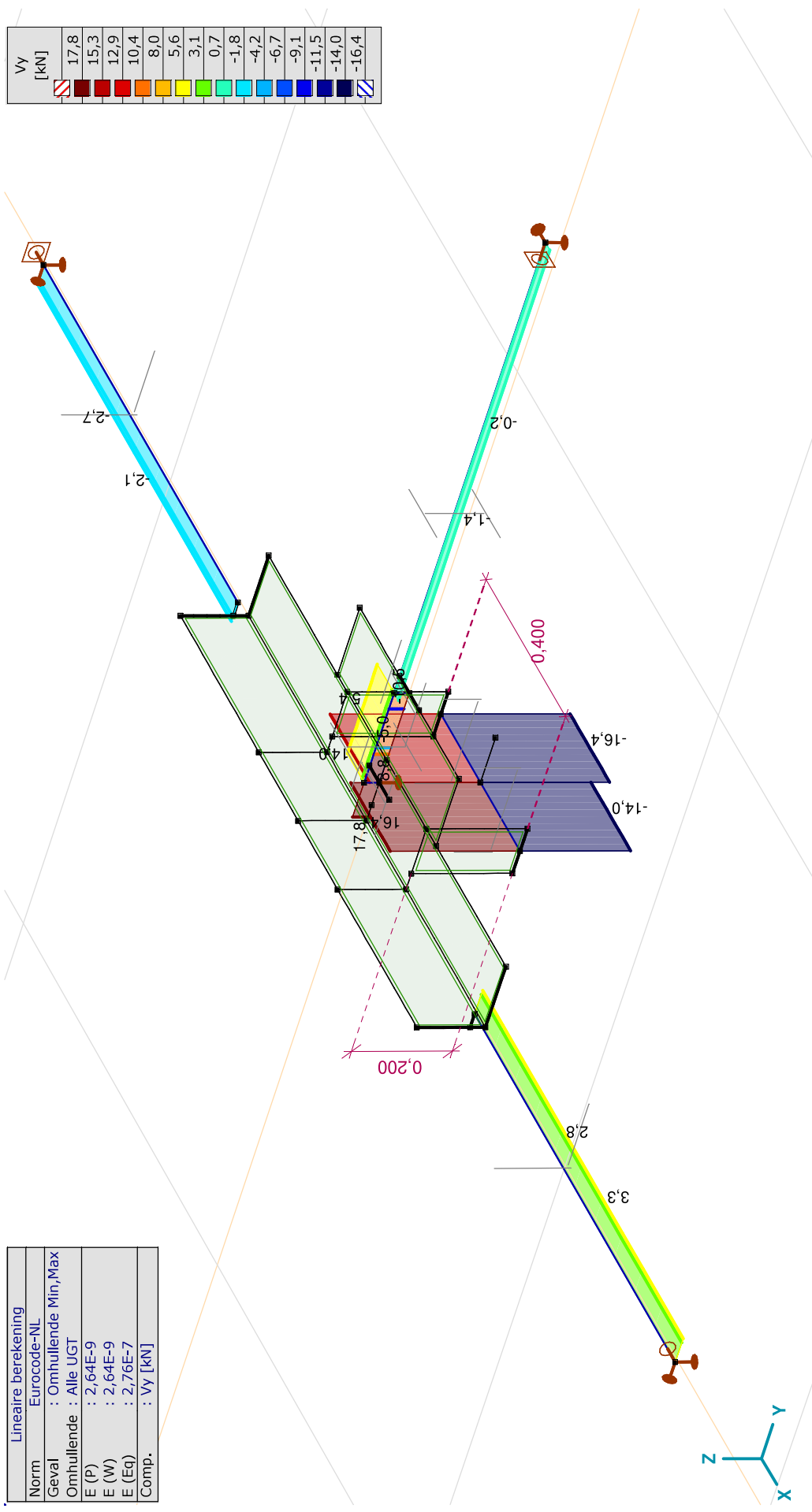

[1] Lineair, Omhullende (Alle UGT), Vy, Lijnen (gevuld)

Project:
 Constructeur: DNV GL - Energy
 Model: Post aan onderstrand.axs

Lineaire berekening	
Norm	Eurocode-NL
Geval	: Omhullende Min,Max
Omhullende	: Alle UGT
E (P)	: 2,64E-9
E (W)	: 2,64E-9
E (Eq)	: 2,76E-7
Comp.	: Tx [kNm]

Tx [kNm]
1,2
1,0
0,9
0,7
0,5
0,3
0,2
0
-0,2
-0,3
-0,5
-0,7
-0,9
-1,0
-1,2

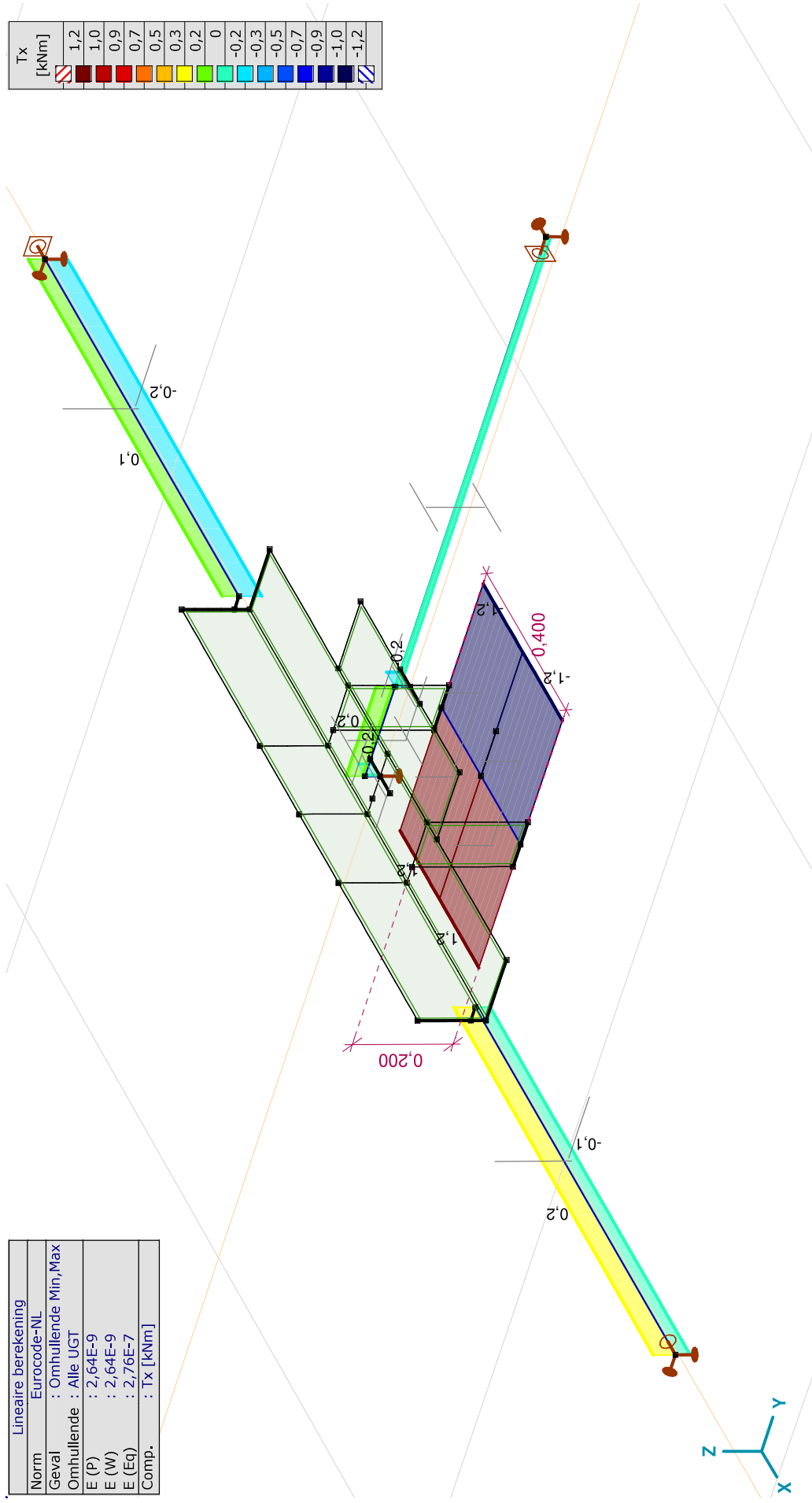

[!], Lineair, Omhullende (Alle UGT), Tx, Lijnen (gevuld)

Project:

Constructeur: DNV GL - Energy

Model: Post aan onderrand.axs

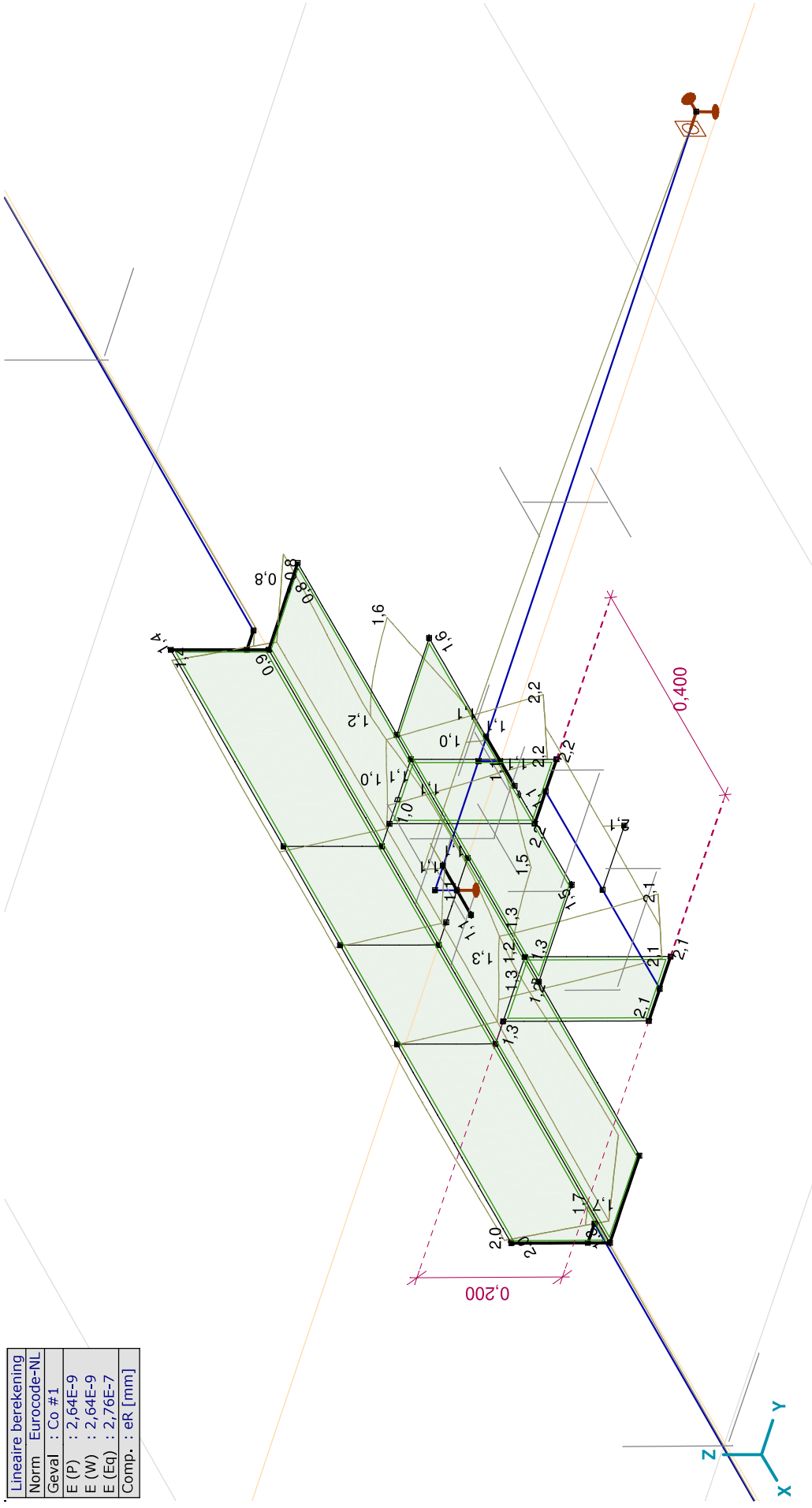

Lineaire berekening	
Norm	Eurocode-NL
Geval	: Co #1
E (P)	: 2,64E-9
E (W)	: 2,64E-9
E (Eq)	: 2,76E-7
Comp.	: eR [mm]

[I], Lineair, Co #1 (UGT), eR, Lijnen

Project:

Constructeur: DNV GL - Energy

Model: **Post aan onderrand.axs**

Lineaire berekening
Norm Eurocode-NL
Geval : Co #2
E (P) : 2,64E-9
E (W) : 2,64E-9
E (Eq) : 2,76E-7
Comp. : eR [mm]

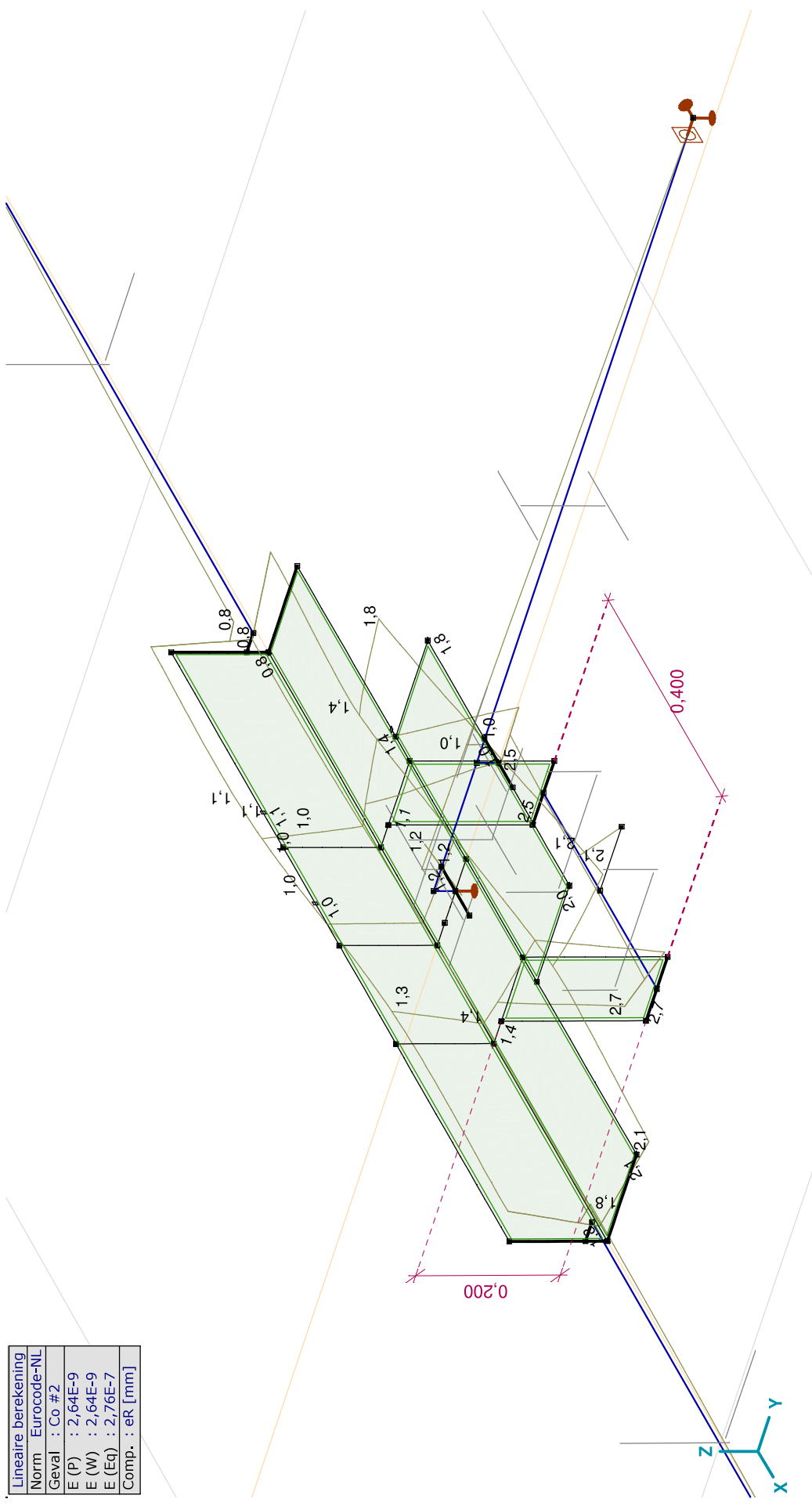

[1], Lineair, Co #2 (UGT), eR, Lijnen

Project:
Constructeur: DNV GL - Energy
Model: Post aan onderrand.axs

Lineaire berekening
Norm Eurocode-NL
Geval : Co #3
E (P) : 2,64E-9
E (W) : 2,64E-9
E (Eq) : 2,76E-7
Comp. : eR [mm]

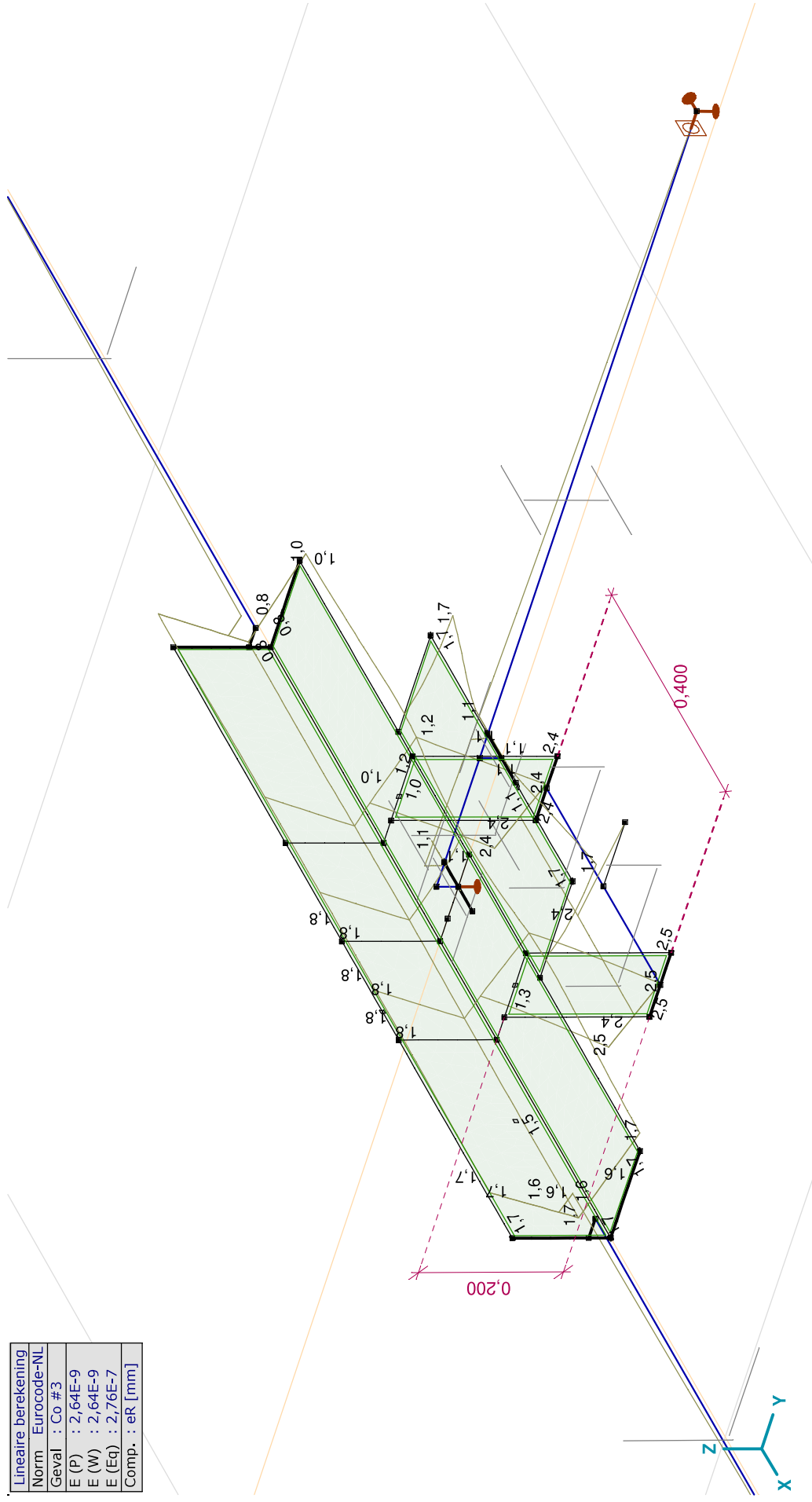

[I], Lineair, Co #3 (UGT), eR, Lijnen

Project:
 Constructeur: DNV GL - Energy
 Model: Post aan onderrand.axs

Lineaire berekening	
Norm	Eurocode-NL
Geval	: Co #4
E (P)	: 2,64E-9
E (W)	: 2,64E-9
E (Eq)	: 2,76E-7
Comp.	: eR [mm]

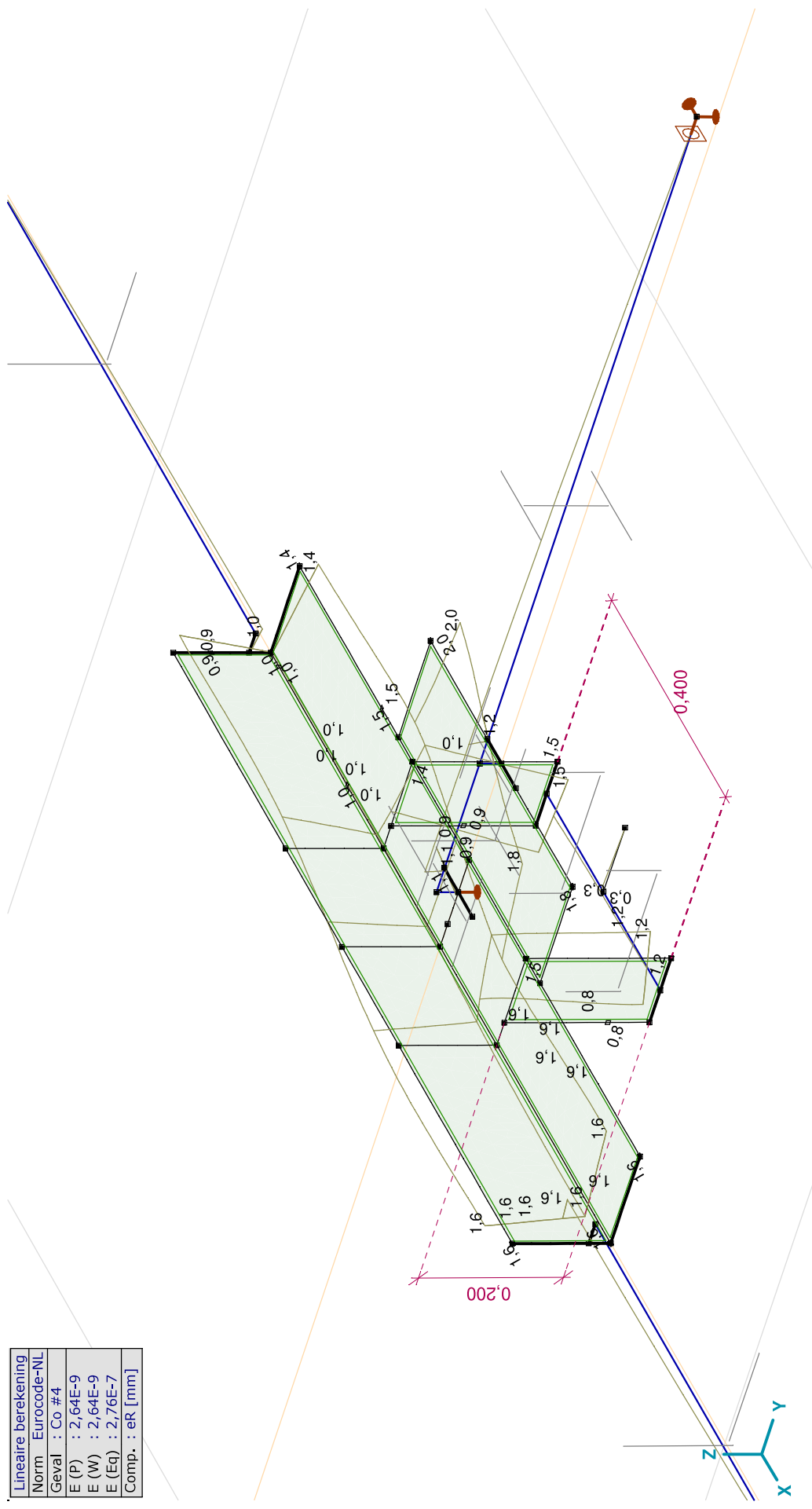

[I], Lineair, Co #4 (UGT), eR, Lijnen

Project:

Constructeur: DNV GL - Energy

Model: Post aan onderrand.axs

6-3-2021

Pag. 23

Lineaire berekening	
Norm	Eurocode-NL
Geval	: Co #5
E (P)	: 2,64E-9
E (W)	: 2,64E-9
E (Eq)	: 2,76E-7
Comp.	: eR [mm]

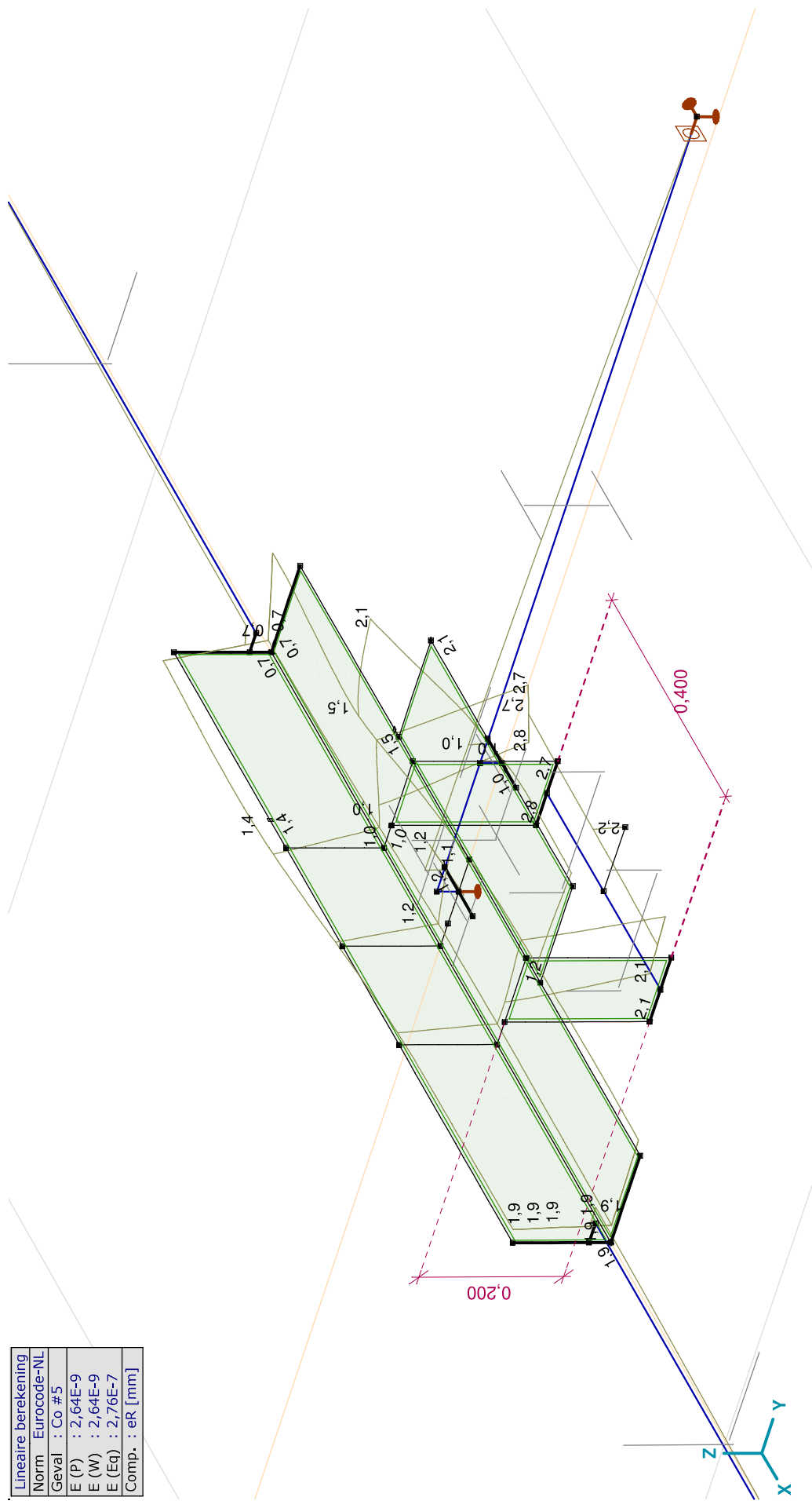

[I], Lineair, Co #5 (UGT), eR, Lijnen

Project:

Constructeur: DNV GL - Energy

Model: Post aan onderstrand.axs

Lineaire berekening	
Norm	Eurocode-NL
Geval	: Co #6
E (P)	: 2,64E-9
E (W)	: 2,64E-9
E (Eq)	: 2,76E-7
Comp.	: eR [mm]

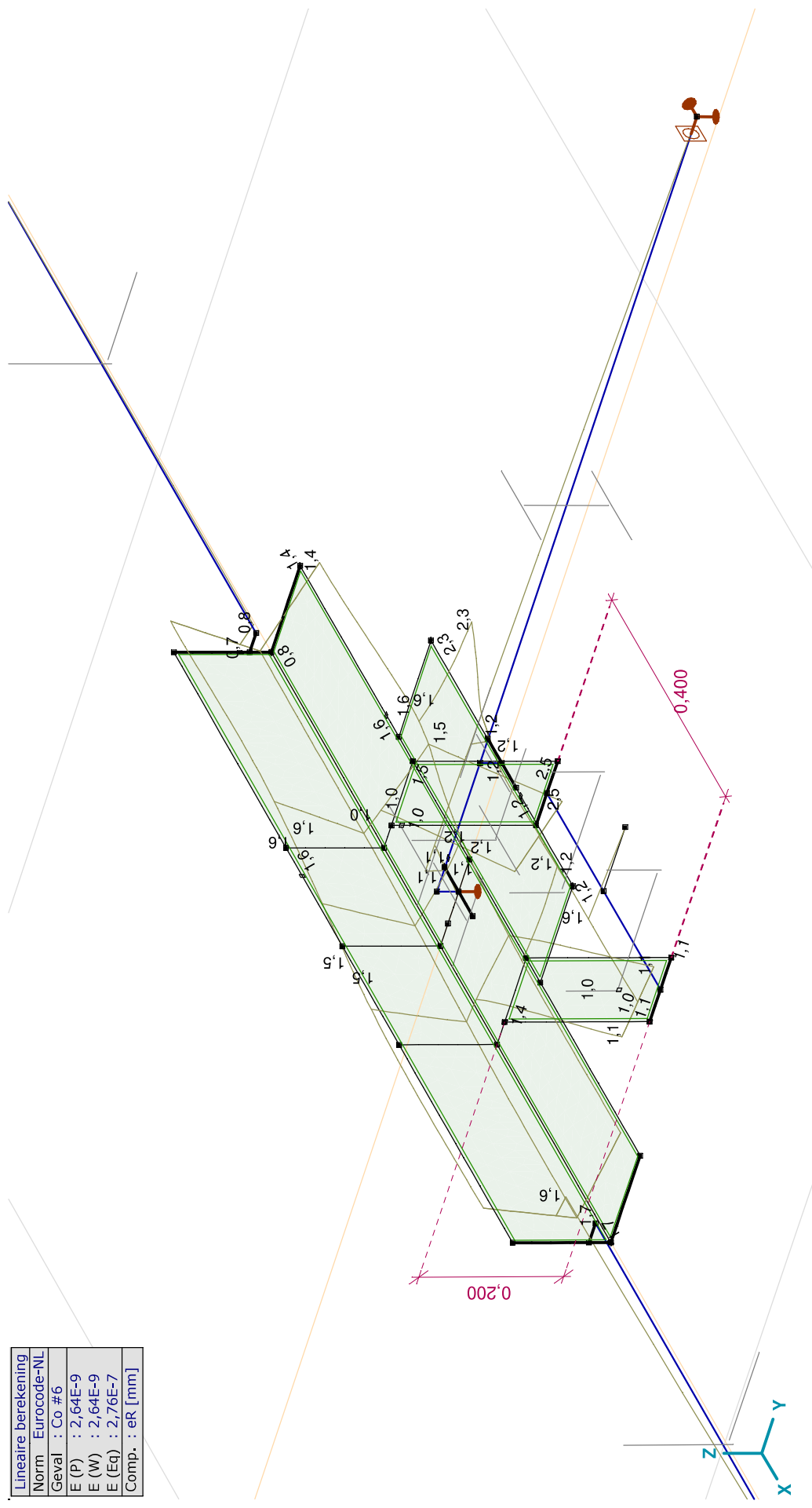

[1]. Lineair, Co #6 (UGT), eR, Lijnen

Project:
 Constructeur: DNV GL - Energy
 Model: Post aan onderrand.axs

Lineaire berekening	
Norm	Eurocode-NL
Geval	: Co #1
E (P)	: 2,64E-9
E (W)	: 2,64E-9
E (Eq)	: 2,76E-7
Comp.	: SVM T [N/mm ²]

SVM T [N/mm ²]	
355,0	
329,8	
304,6	
279,4	
254,3	
229,1	
203,9	
178,7	
153,5	
128,3	
103,2	
78,0	
52,8	
27,6	
2,4	

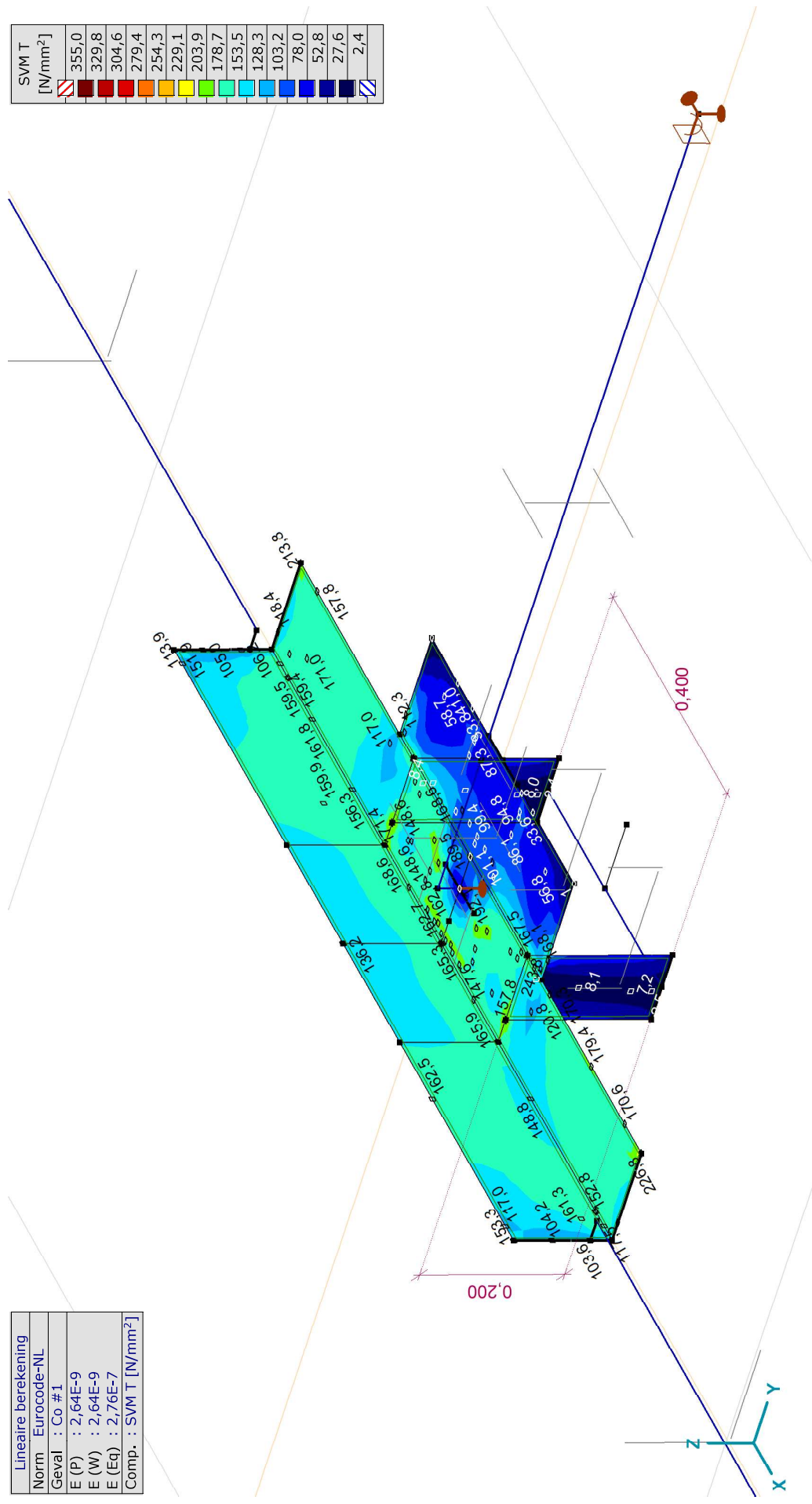

[I], Lineair, Co #1 (UGT), SVM T, Kleuren 2D

Project:
 Constructeur: DNV GL - Energy
 Model: Post aan onderrand.axs

Lineaire berekening	
Norm	Eurocode-NL
Geval	: Co #2
E (P)	: 2,64E-9
E (W)	: 2,64E-9
E (Eq)	: 2,76E-7
Comp.	: SVM T [N/mm ²]

SVM T [N/mm ²]	
355,0	
329,8	
304,6	
279,4	
254,3	
229,1	
203,9	
178,7	
153,5	
128,3	
103,2	
78,0	
52,8	
27,6	
2,4	

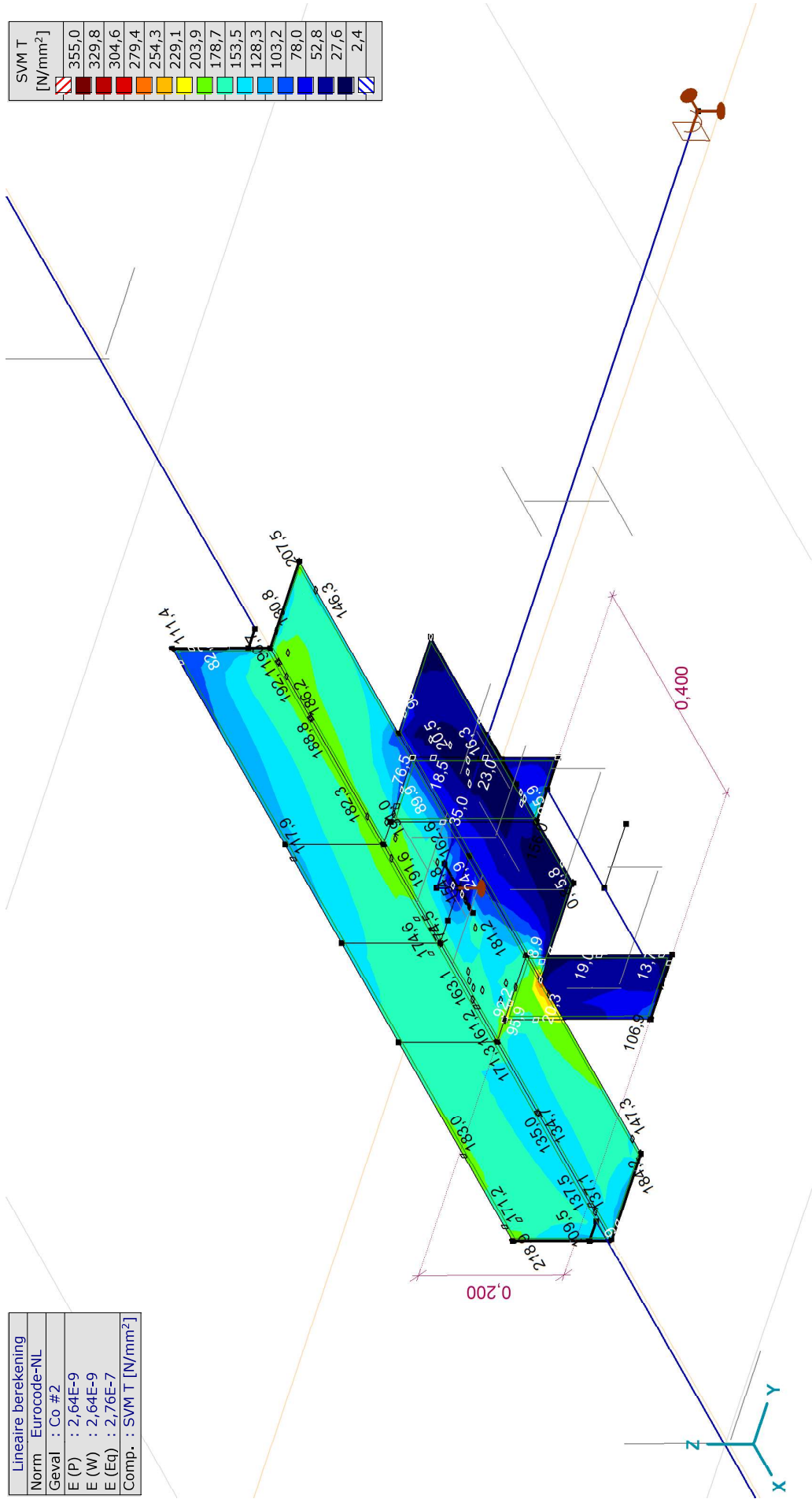

[I], Lineair, Co #2 (UGT), SVM T, Kleuren 2D

Project:
 Constructeur: DNV GL - Energy
 Model: Post aan onderrand.axs

Lineaire berekening
Norm Eurocode-NL
Geval : Co #3
E (P) : 2,64E-9
E (W) : 2,64E-9
E (Eq) : 2,76E-7
Comp. : SVM T [N/mm ²]

SVM T [N/mm ²]
355,0
329,8
304,6
279,4
254,3
229,1
203,9
178,7
153,5
128,3
103,2
78,0
52,8
27,6
2,4

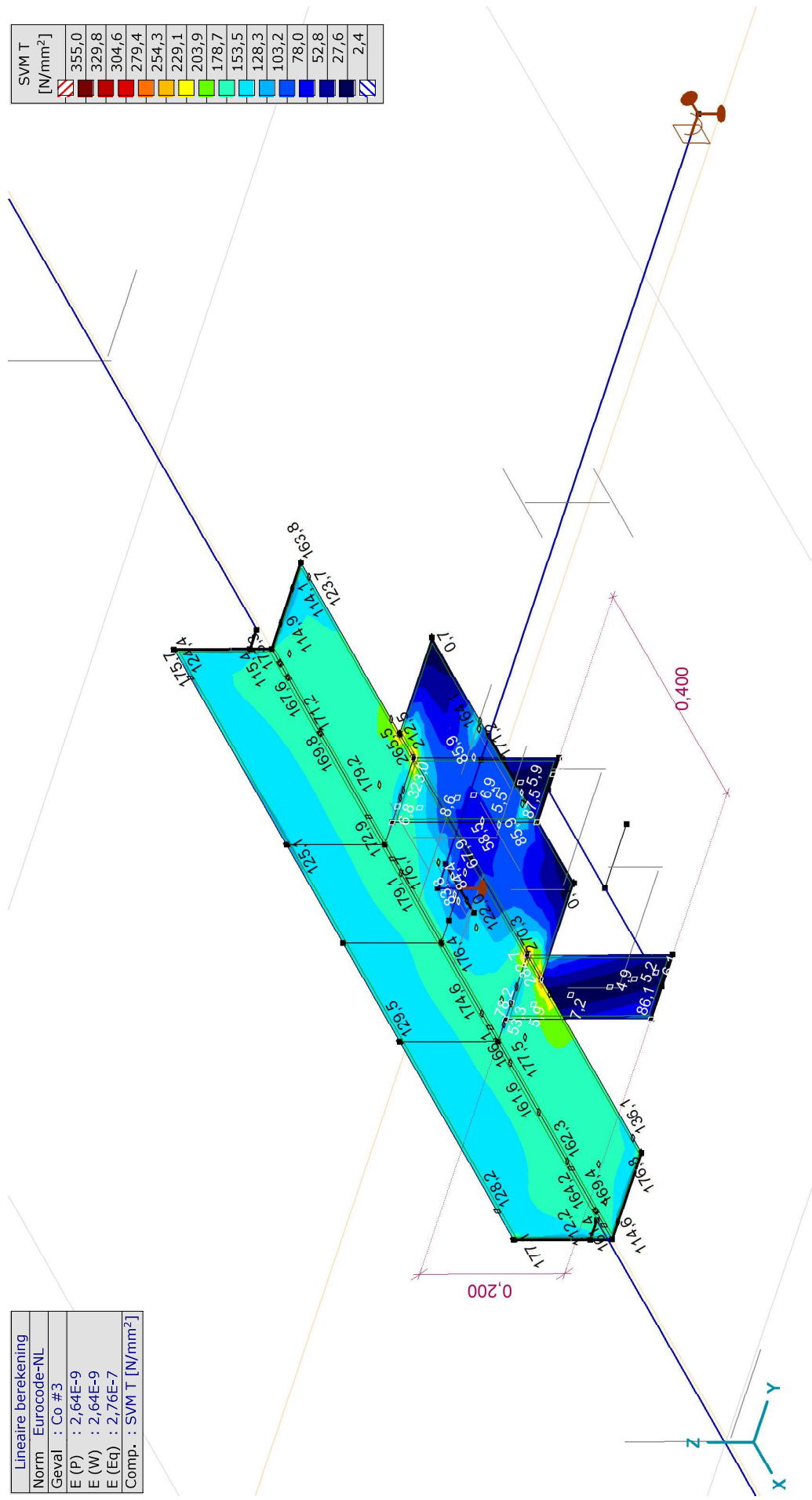

[I], Lineair, Co #3 (UGT), SVM T, Kleuren 2D

Project:
 Constructeur: DNV GL - Energy
 Model: Post aan onderstrand.axs

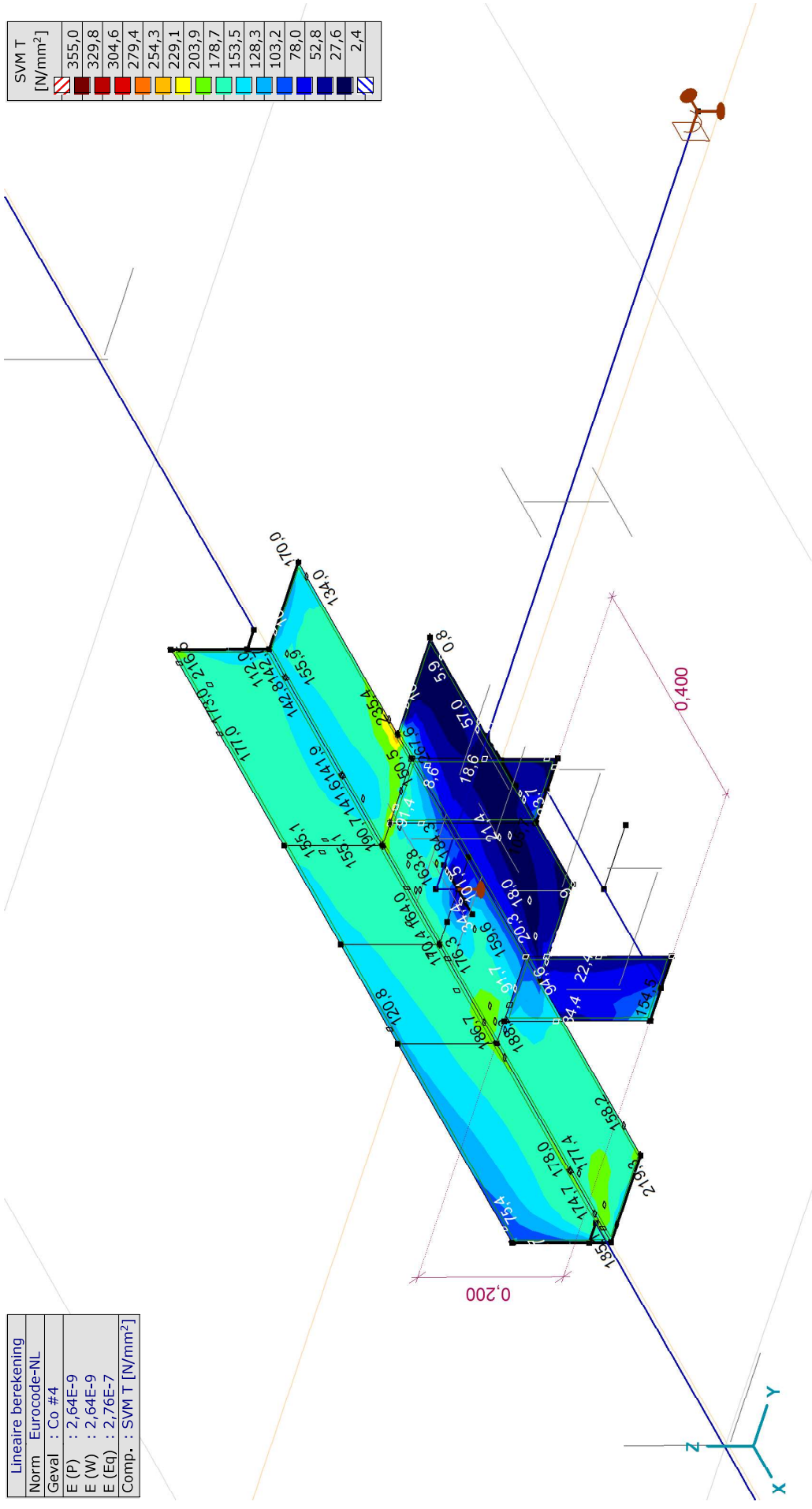

Lineaire berekening	
Norm	Eurocode-NL
Geval	: Co #4
E (P)	: 2,64E-9
E (W)	: 2,64E-9
E (Eq)	: 2,76E-7
Comp.	: SVM T [N/mm²]

[I], Lineair, Co #4 (UGT), SVM T, Kleuren 2D

Project:
 Constructeur: DNV GL - Energy
 Model: Post aan onderrand.axs

Lineaire berekening	
Norm	Eurocode-NL
Geval	: Co #5
E (P)	: 2,64E-9
E (W)	: 2,64E-9
E (Eq)	: 2,76E-7
Comp.	: SVM T [N/mm ²]

SVM T [N/mm ²]	Color/Pattern
355,0	White
329,8	Red
304,6	Orange
279,4	Yellow
254,3	Light Green
229,1	Green
203,9	Light Blue
178,7	Blue
153,5	Dark Blue
128,3	Very Dark Blue
103,2	Black
78,0	Dark Blue
52,8	Very Dark Blue
27,6	Black
2,4	White

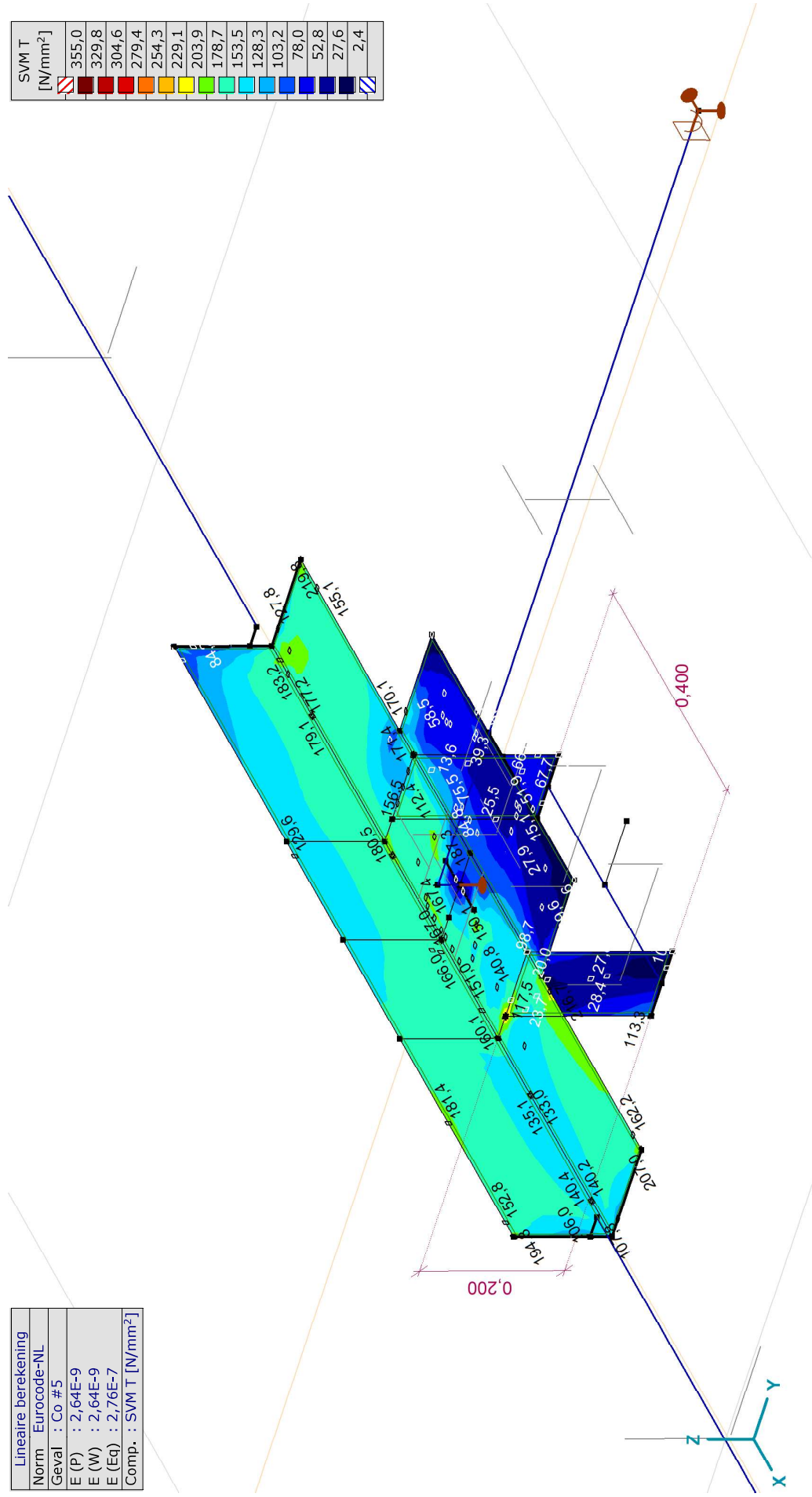

[I], Lineair, Co #5 (UGT), SVM T, Kleuren 2D

Project:
 Constructeur: DNV GL - Energy
 Model: Post aan onderrand.axs

Lineaire berekening	
Norm	Eurocode-NL
Geval	: Co #6
E (P)	: 2,64E-9
E (W)	: 2,64E-9
E (Eq)	: 2,76E-7
Comp.	: SVM T [N/mm ²]

SVM T [N/mm ²]	
355,0	[Red diagonal hatching]
329,8	[Dark red]
304,6	[Red]
279,4	[Orange-red]
254,3	[Orange]
229,1	[Yellow-orange]
203,9	[Yellow]
178,7	[Light green]
153,5	[Green]
128,3	[Light blue-green]
103,2	[Light blue]
78,0	[Blue]
52,8	[Dark blue]
27,6	[Very dark blue]
2,4	[Dark blue with diagonal hatching]

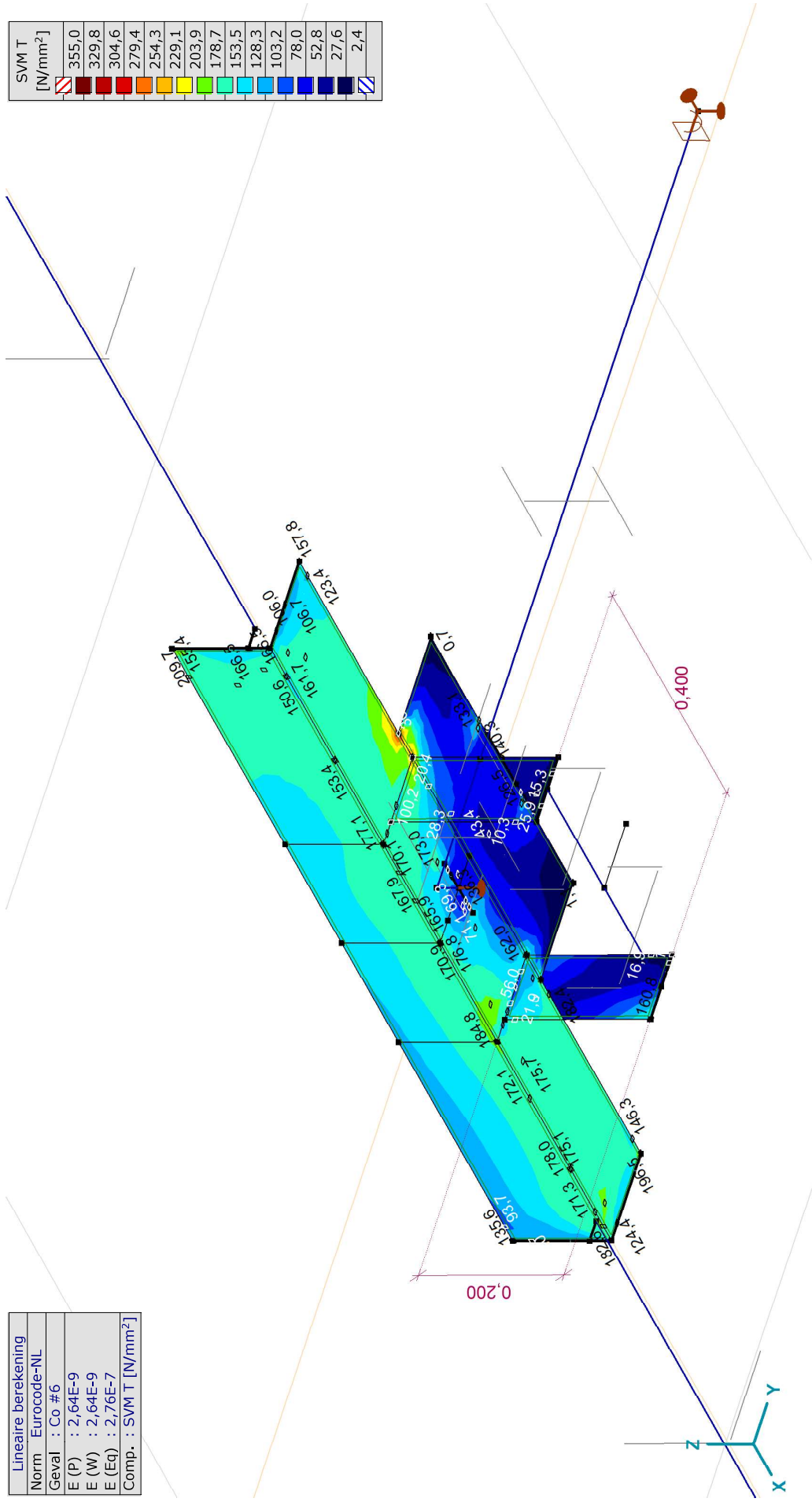

[I], Lineair, Co #6 (UGT), SVM T, Kleuren 2D

Project:
 Constructeur: DNV GL - Energy
 Model: Post aan onderstrand.axs

Lineaire berekening	
Norm	Eurocode-NL
Geval	: Omhullende Min,Max
Omhullende	: Alle UGT
E (P)	: 2,64E-9
E (W)	: 2,64E-9
E (Eq)	: 2,76E-7
Comp.	: SVM B [N/mm ²]

SVM B [N/mm ²]
299,0
277,7
256,4
235,1
213,7
192,4
171,1
149,7
128,4
107,1
85,7
64,4
43,1
21,8
0,4

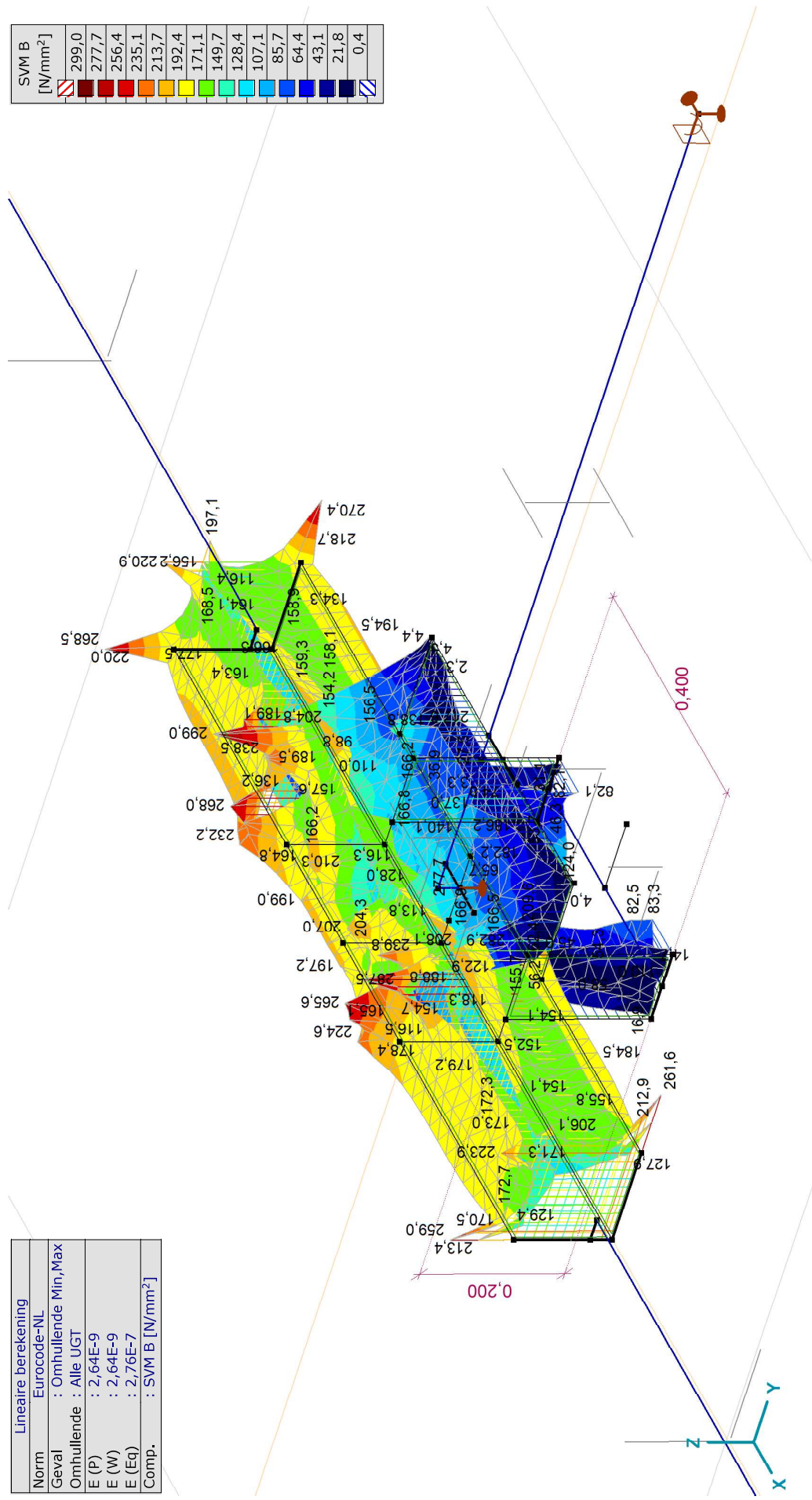

[[J], Lineair, Omhullende (Alle UGT), SVM B, Iso vlakken 3D

Project:
 Constructeur: DNV GL - Energy
 Model: Post aan onderstrand.axs

Lineaire berekening	
Norm	Eurocode-NL
Geval	: Omhullende Min,Max
Omhullende	: Alle UGT
E (P)	: 2,64E-9
E (W)	: 2,64E-9
E (Eq)	: 2,76E-7
Comp.	: SVM C [N/mm ²]

SVM C [N/mm ²]
229,8
213,4
197,1
180,7
164,4
148,0
131,7
115,3
99,0
82,6
66,3
49,9
33,6
17,2
0,9

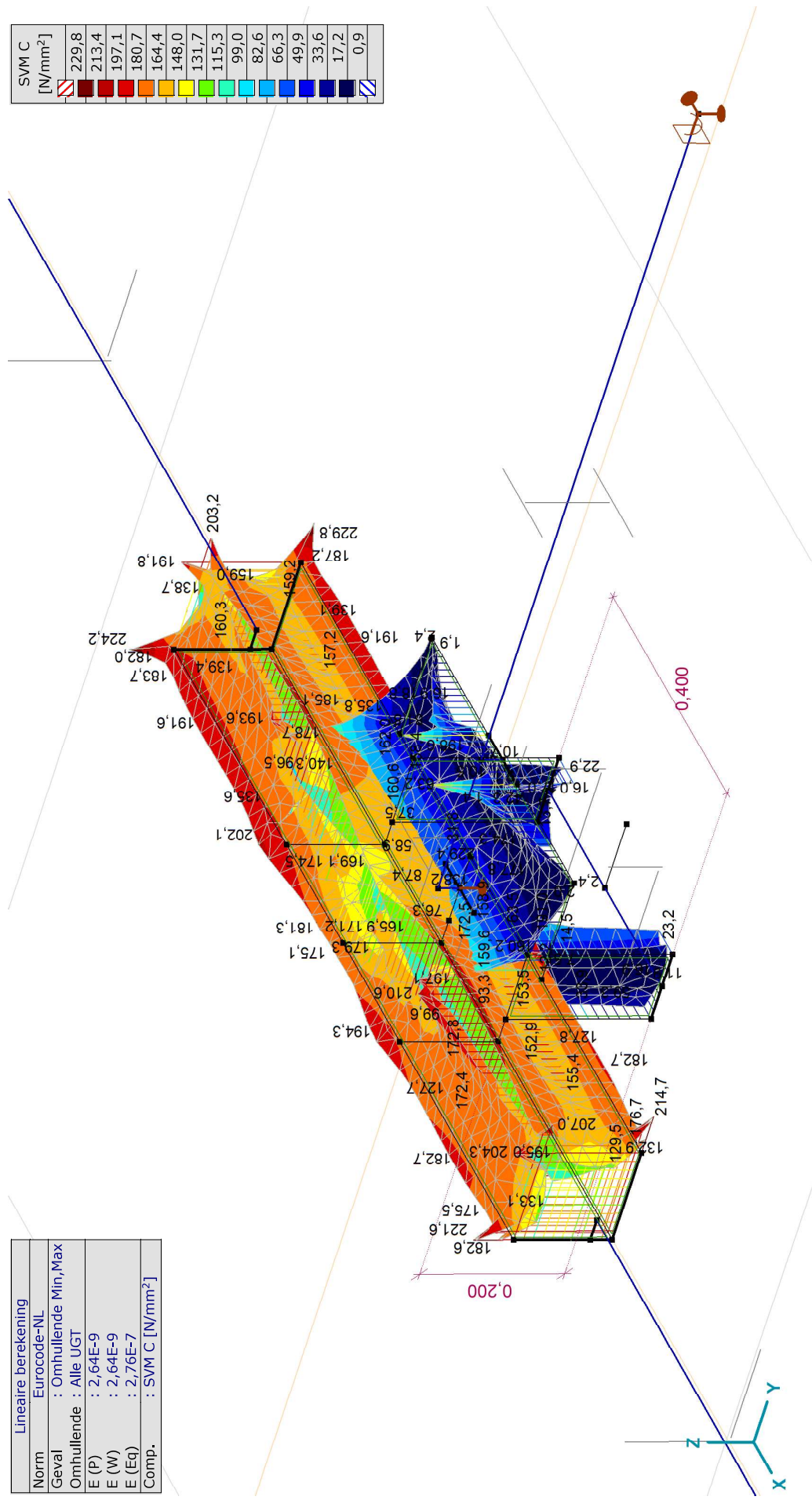

[[J], Lineair, Omhullende (Alle UGT), SVM C, Iso vlakken 3D

Project:
 Constructeur: DNV GL - Energy
 Model: Post aan onderstrand.axs

Lineaire berekening	
Norm	Eurocode-NL
Geval	: Omhullende Min,Max
Omhullende	: Alle UGT
E (P)	: 2,64E-9
E (W)	: 2,64E-9
E (Eq)	: 2,76E-7
Comp.	: SVM T [N/mm ²]

SVM T [N/mm ²]
323,0
300,0
276,9
253,9
230,9
207,9
184,9
161,8
138,8
115,8
92,8
69,7
46,7
23,7
0,7

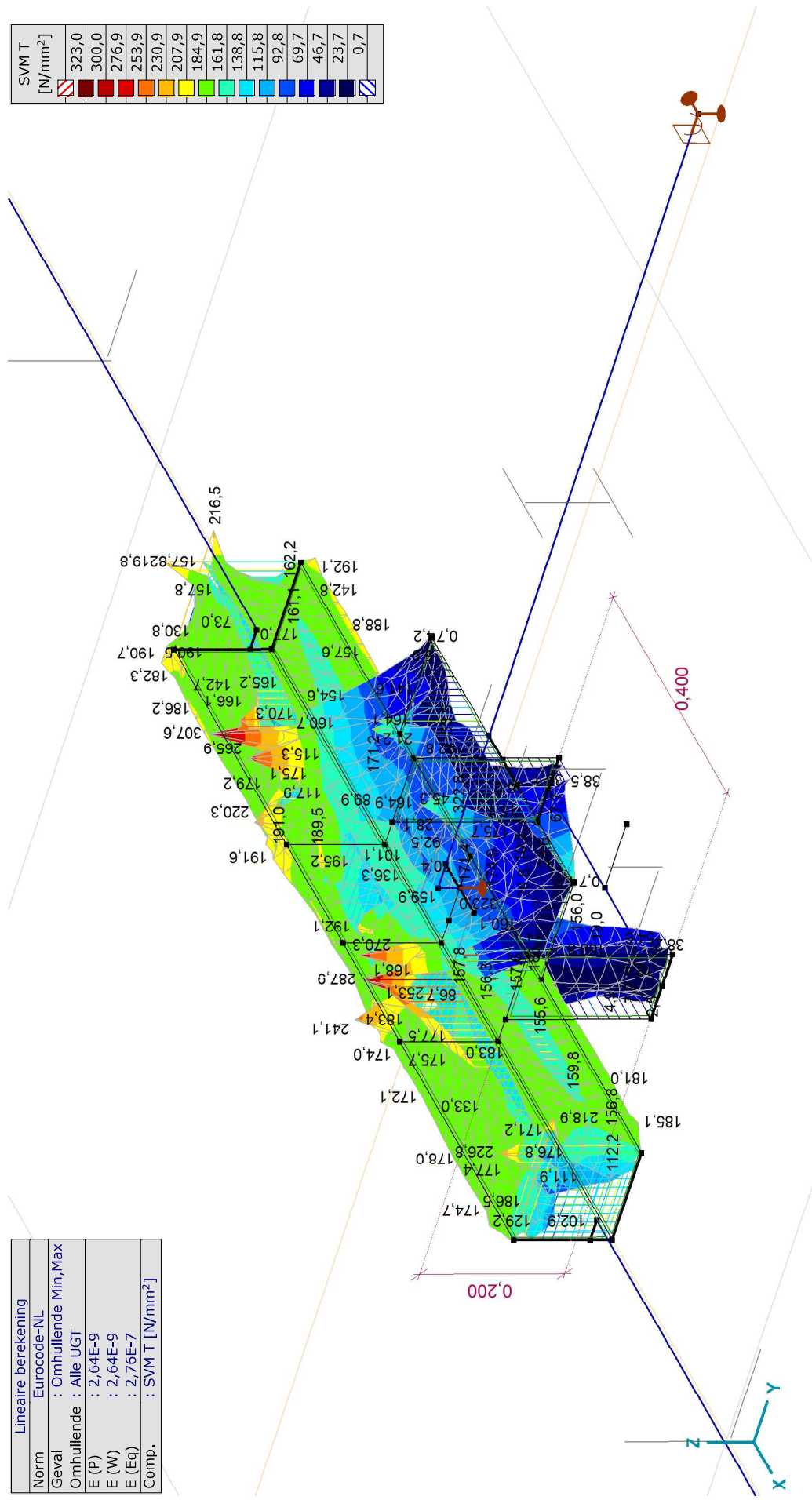

[[J], Lineair, Omhullende (Alle UGT), SVM T, Iso Vlakken 3D

Project:

Constructeur: DNV GL - Energy

Model: Post aan onderrand.axs

6-3-2021

Pag. 34

Vlakspanningen [Lineair, Omhullende (Alle UGT)]

Knoop	C	min. max.	Geval	Oppervlak	Pos.	Sxx [N/mm ²]	Syy [N/mm ²]	Szz [N/mm ²]	Sxy [N/mm ²]	Sxz [N/mm ²]	Syz [N/mm ²]	SVM [N/mm ²]	S1 [N/mm ²]	S2 [N/mm ²]	aS [°]
Ext.															
39	SVM	min	Co #5	Sch 174	B	0,4	0,4	0	-0,1	0	0	0,4	0,5	0,3	-60,05
5		max	Co #3	Sch 1	T	49,7	281,3	0	-110,4	0	0	322,8	325,5	5,6	-68,18
8		max	Co #3	Sch 65	T	48,6	282,4	0	109,4	0	0	323,0	325,6	5,4	68,44

Knoop: Index; **C:** Extreme component; **min, max.:** Extreme type; **Geval:** Belastinggeval van de extreme; **Oppervlak:** Vlak behorend bij knoop; **Pos.:** Punt voor spanningsberekening; **Sxx:** Normalspanning in lokale x-richting; **Syy:** Normalspanning in lokale y-richting; **Szz:** Normalspanning in lokale z-richting; **Sxy, Syz:** Draai-/Schuifspanning; **Sx, Syz:** Draai-/Schuifspanning; **SVM:** Von Mises spanning; **S1:** Primaire spanning 1; **S2:** Primaire spanning 2; **aS:** Richting primaire spanning;

Project:
 Constructeur: DNV GL - Energy
 Model: Post aan onderstrand.axs

Norm	Lineaire berekening
Geval	Eurocode-NL
Omhullende	: Omhullende Min,Max
E (P)	: 2,64E-9
E (W)	: 2,64E-9
E (Eq)	: 2,76E-7
Comp.	: S;x:minmax [N/mm ²]

S;x:minmax [N/mm ²]	
96,3	
74,9	
53,6	
32,3	
11,0	
-10,3	
-31,6	
-53,0	
-74,3	
-95,6	
-116,9	
-138,2	
-159,5	
-180,8	
-202,2	

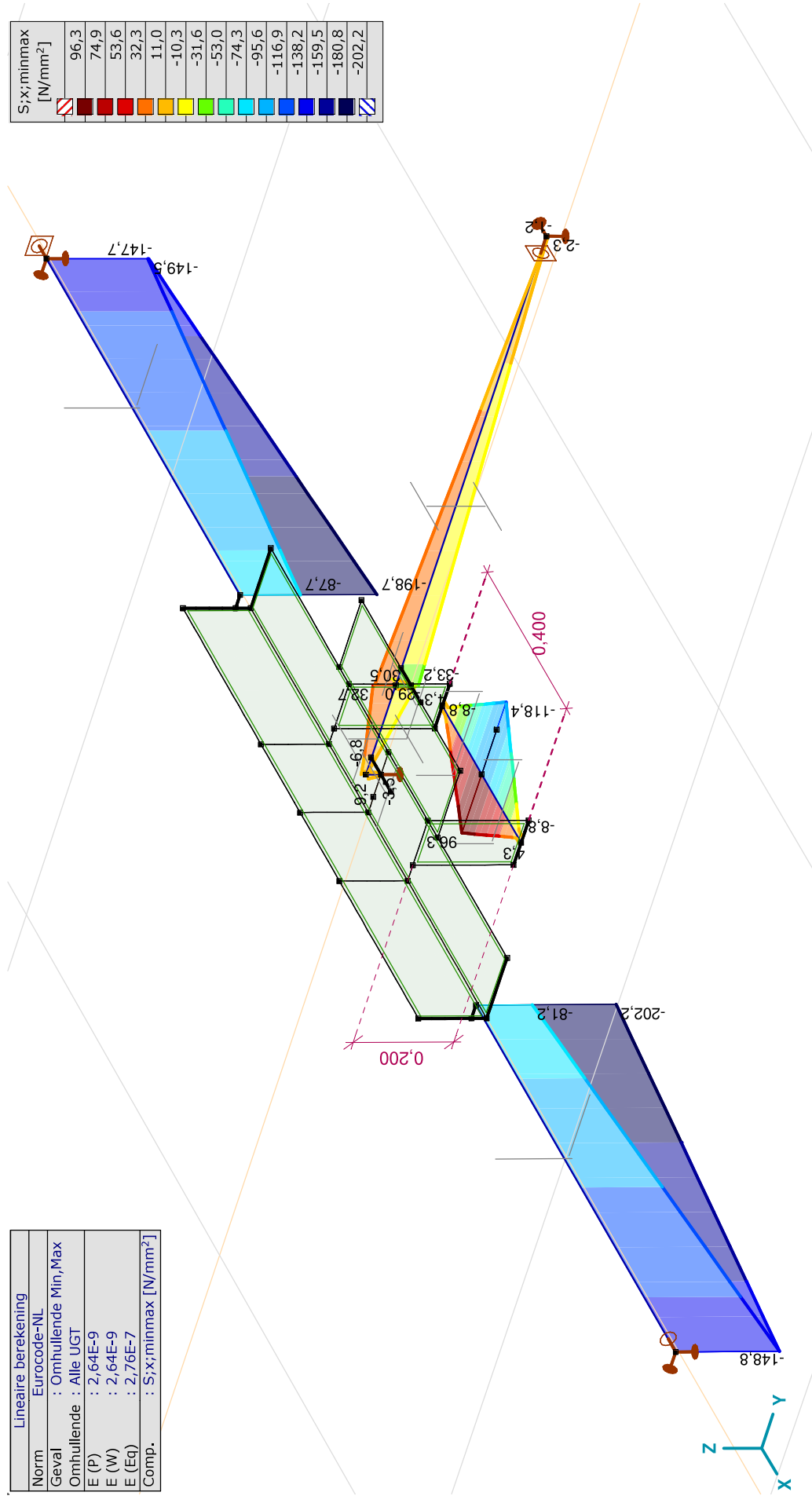

[I]. Lineair, Omhullende (Alle UGT), S;x:minmax, Lijnen (gevuld)

Project:

Constructeur: DNV GL - Energy

Model: **Post aan onderrand.axs**

6-3-2021

Pag. 36

Staafspanningen [Lineair, Omhullende (Alle UGT)]

Ext.	Prof.	Doorsnede naam	C	min. max.	Geval	Pos. [m]	Knoop	S:x:min [N/mm ²]	S:x:max [N/mm ²]	Vmin [N/mm ²]	Vmax [N/mm ²]	Somin [N/mm ²]	Somax [N/mm ²]	V:y:gem [N/mm ²]	V:z:gem [N/mm ²]
6	3	HE 140 A	Somax	min	Co #2	1,000	(51)	-1,8	-1,8	0,4	0,7	1,9	2,1	-0,1	0
4	2	L 150X150X14	Somax	max	Co #2	0	(33)	-202,2	-81,2	0	5,8	81,8	202,4	0,7	0,7

Prof.: Profiel; **C:** Extreme component; **min. max.:** Extreme type; **Geval:** Belastinggeval van de extreme; **Pos.:** Lokale X-positie van de doorsnede op de staaf; **S:x:min:** Doorsnede minimum normaalspanning; **S:x:max:** Doorsnede maximum normaalspanning;

Vmin: Doorsnede minimum afschuifspanning; **Vmax:** Doorsnede maximum afschuifspanning; **Somin:** Doorsnede minimum Von Mises spanning; **Somax:** Doorsnede maximum Von Mises spanning; **V:y:gem:** Afschuifspanning in lokale Y-richting;

V:z:gem: Afschuifspanning in lokale Z-richting;

Project:

Constructeur: DNV GL - Energy
 Model: **Post aan onderrand.axs**

Interne krachten knooppoplegging [Lineair, Omhullende (Alle UGT)]

	Knoop	X [m]	Y [m]	Z [m]	Type	C	min. max.	Geval	Rx [kN]	Ry [kN]	Rz [kN]	Rr [kN]	Rxx [kNm]	Ryy [kNm]	Rrr [kNm]	αR		
1	31	-1,600	0,030	0,030	Glob.	Rx	min	Co #2	-602,8	-2,7	1,2	602,8	0,1			0,1	494,075	
							max	Co #4	-595,6	-2,1	-2,8	595,6	-0,1			0,1	-209,474	
							min	Co #2	-602,8	-2,7	1,2	602,8	0,1			0,1	494,075	
							max	Co #4	-595,6	-2,1	-2,8	595,6	-0,1			0,1	-209,474	
							min	Co #4	-595,6	-2,1	-2,8	595,6	-0,1			0,1	-209,474	
							max	Co #2	-602,8	-2,7	1,2	602,8	0,1			0,1	494,075	
2	34	1,600	0,030	0,030	Glob.	Ry	min	Co #4	-3,3	-3,3	1,2	3,6	0,1			0,1	2,696	
							max	Co #2	-2,8	-2,8	-2,8	4,0	-0,1			0,1	-0,977	
							min	Co #2	-2,8	-2,8	-2,8	4,0	-0,1			0,1	-0,977	
							max	Co #4	-3,3	-3,3	1,2	3,6	0,1			0,1	2,696	
							min	Co #4	-3,3	-3,3	1,2	3,6	0,1			0,1	2,696	
							max	Co #2	-2,8	-2,8	-2,8	4,0	-0,1			0,1	-0,977	
3	51	0	1,285	0,030	Glob.	Rx	min	Co #4	-1,4	5,5	0	5,6			0	0	-209,038	
							max	Co #2	-0,2	5,5	0	5,5	0		0	0	-202,439	
							min	Co #3	-0,8	3,8	-2,1	4,4	0		0	0	-1,844	
							max	Co #1	-0,8	7,2	2,0	7,5	0		0	0	3,588	
							min	Co #3	-0,8	3,8	-2,1	4,4	0		0	0	-1,844	
							max	Co #1	-0,8	7,2	2,0	7,5	0		0	0	3,588	
4	10	0	0,085	0	Glob.	Rz	min	Co #1	-2,1		-2,1	2,1					0	
							max	Co #3	0,6		0,6							0
							min	Co #2	-602,8	-2,7	1,2	602,8	0,1			0,1	494,075	
							max	Co #2	-0,2	5,5	0	5,5	0		0	0	-202,439	
							min	Co #4	-3,3	-3,3	1,2	3,6	0,1			0,1	2,696	
							max	Co #1	-0,8	7,2	2,0	7,5	0		0	0	3,588	
Ext.	31	-1,600	0,030	0,030	Glob.	Rx	min	Co #2	-602,8	-2,7	1,2	602,8	0,1			0,1	494,075	
							max	Co #2	-0,2	5,5	0	5,5	0		0	0	-202,439	
							min	Co #4	-3,3	-3,3	1,2	3,6	0,1			0,1	2,696	
							max	Co #1	-0,8	7,2	2,0	7,5	0		0	0	3,588	
							min	Co #4	-595,6	-2,1	-2,8	595,6	-0,1			0,1	-209,474	
							max	Co #1	-0,8	7,2	2,0	7,5	0		0	0	3,588	

Knoop: Ondersteunde knoop; **Type:** Opleggingstype; **C:** Extremer component; **min, max:** Extremer type; **Geval:** Belastingval van de extremer; **Rx:** X-component opleggingreactiekracht; **Ry:** Y-component opleggingreactiekracht; **Rz:** Z-component opleggingreactiekracht; **Rr:** Resultierende opleggingreactiekracht; **Rxx:** X-component opleggingreactiemoment; **Ryy:** Y-component opleggingreactiemoment; **Rrr:** Resultierende verticale opleggingreactiekracht / horizontale opleggingreactiekracht;

Project: RLL-TBG
Mast: HA+0_c

Steel beams in torsion

Calculation of unrestrained beams with eccentric load

Datum: 2021-02-22

Auteur: MRE

Versie: 1.1

Load		Beam 1	Beam 2	Beam 3	Beam 4	
Force on insulator		6.88				kN
Angle of insulator (to vertical)		54				°
Horizontal force in direction of Horizontal force	F _h	5.6				kN
Vertical force	F _v	4.0				kN
Eccentricity of force (below beam)	e	3375				mm
Torsional moment	T	19.4				kNm
Beams						
Beam length	L	1820				mm
Yield stress	f _y	355				Mpa
Elastic modulus	E	210000				Mpa
Shear modulus	G	81000				Mpa
Profile		HEB 220				
		HEB220				
Height	h	220				mm
Width	b	220				mm
Web thickness	t _w	9.5				mm
Flange thickness	t _f	16.0				mm
Torsional constant	I _t	77				· 10 ⁴ mm ⁴
Warping constant	I _{wa}	295418				· 10 ⁶ mm ⁶
Moment of inertia	I _y	8091				· 10 ⁴ mm ⁴
	I _z	2843				· 10 ⁴ mm ⁴
Flange stiffness	I _f = I _z / 2 =	1422				mm ³
Moment of resistance	W _{y,el}	736				· 10 ³ mm ³
	W _{z,el}	258				· 10 ³ mm ³
Torsional bending constant	d	997				mm
	L/d	1.8				
	a	0.5				

Calculation of second derivative of angular deflection φ'':

$$\begin{aligned}
 A &= T / (G \cdot I_t \cdot d) = && 3.12E-07 \\
 B &= \sinh(\alpha \cdot L / d) = && 1.04E+00 \\
 C &= \tanh(L/d) = && 9.49E-01 \\
 D &= \cosh(\alpha \cdot L / d) = && 1.45E+00 \\
 F &= \sinh(0.5 \cdot L / d) = && 1.04E+00 \\
 H &= (B / C - D) \cdot F = && -3.61E-01 \\
 X &= A \cdot H = && -1.13E-07 \\
 \\
 Y &= X \cdot G \cdot I_t \cdot d / T = && -3.61E-01 \\
 \phi'' &= Y \cdot T / (G \cdot I_t \cdot d) = && -1.13E-07 \quad \text{rad/mm}^2
 \end{aligned}$$

Project: RLL-TBG
 Mast: HA+0_c

Steel beams in torsion

Calculation of unrestrained beams with eccentric load

Datum: 2021-02-22

Auteur: MRE

Versie: 1.1

Acting moments:

$M_{w,Ed} = E \cdot I_r \cdot (h \cdot t_f) \cdot \phi'' / 2 =$	34.3	<i>kNm</i>
$M_{y,Ed} = 1/4 \cdot F \cdot L =$	1.8	<i>kNm</i>
$M_{z,Ed} = 1/4 \cdot F \cdot L =$	2.5	<i>kNm</i>

Capacities of beams:

$M_{w,Rd} = W_{z,el} \cdot f_y / 2 =$	45.9	<i>kNm</i>
$M_{y,Rd} = W_{y,el} \cdot f_y =$	261.1	<i>kNm</i>
$M_{z,Rd} = W_{z,el} \cdot f_y =$	91.8	<i>kNm</i>

Combined check of beam:

UC 0,78

Displacements:

Factor F_{ed} / F_k		1.2	
Displacement y-direction	u_y	0.02	<i>mm</i>
Relative displacement	rel.	73062	-
Displacement z-direction	u_z	0.10	<i>mm</i>
Relative displacement	rel.	18654	-

APPENDIX F

Sterkte-coördinatie

In 5.5.1 van het uitgangspuntenrapport is beschreven dat aan sterkte-coördinatie wordt voldaan als de U.C. van de staven in de traverse 10 procentpunt groter is dan de U.C. van de staven in het mastlichaam. Uitgangspunt is belastingcombinatie 5a, geleiderbreuk. In deze Appendix wordt getoetst of de U.C. van de staven in het mastlichaam voldoende laag is ten opzichte van de U.C. van de staven in de traverse.

Aangezien alle masttypen in de groep van combi-hoekmasten dezelfde mastkop delen, wordt enkel masttype HA+0/c getoetst. Mogelijk dat andere typen een hoger of lager worden belast, maar dat levert geen verschil op in de verhouding van uitnutting tussen de verschillende onderdelen.

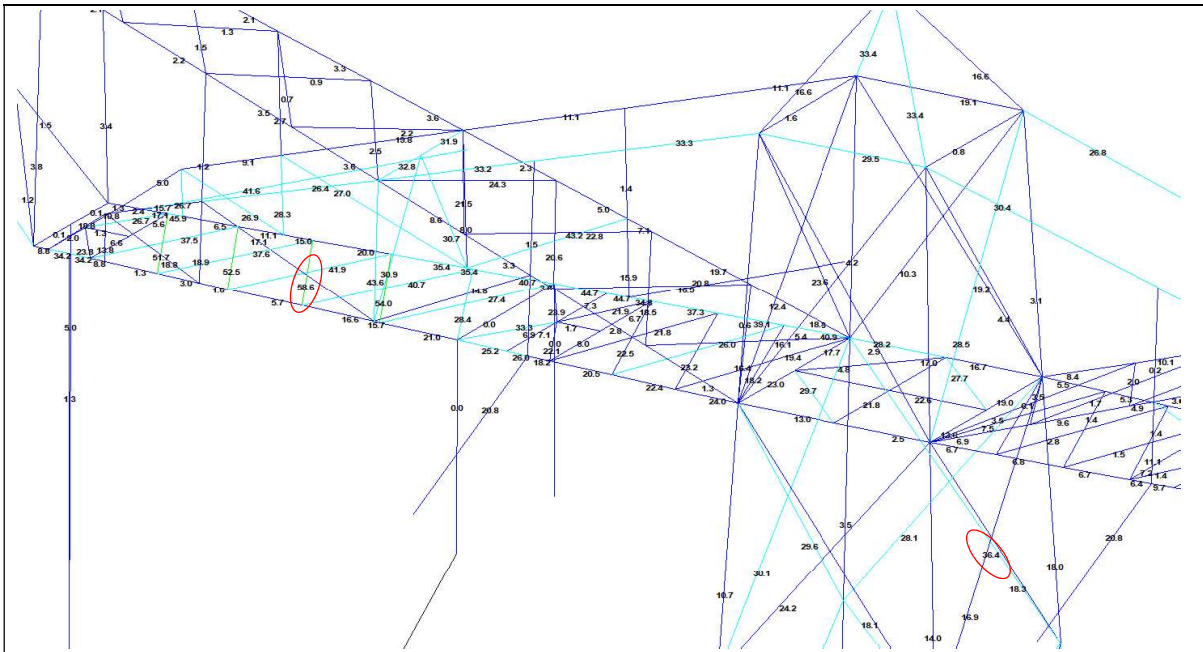

Boventraverse – diagonalen bovenstuk 2: $58,6 / 36,4 = 1,61 \geq 1,10$ OK.

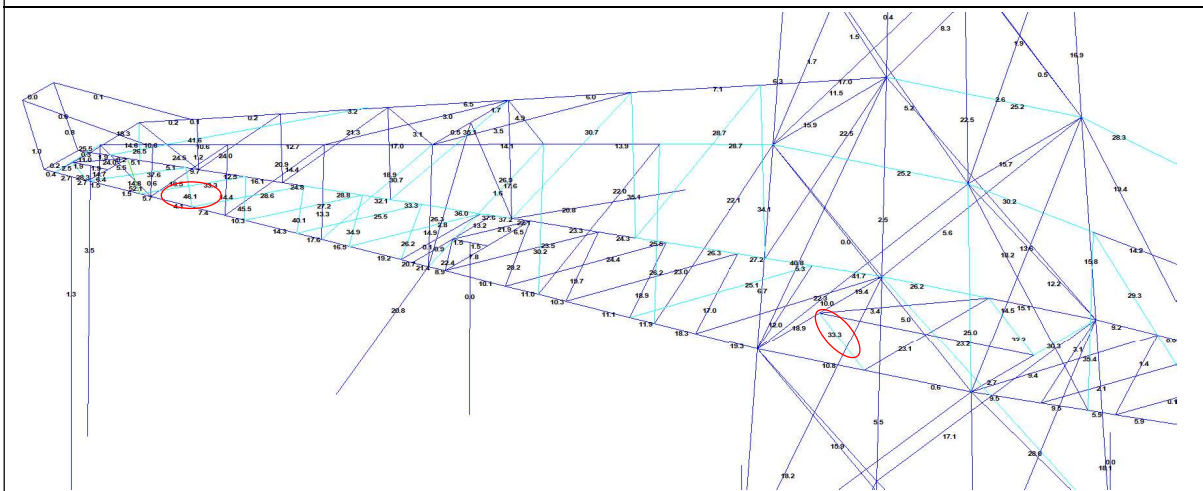

Middentraverse – tussenschot: $46,1 / 33,3 = 1,38 \geq 1,10$ OK.

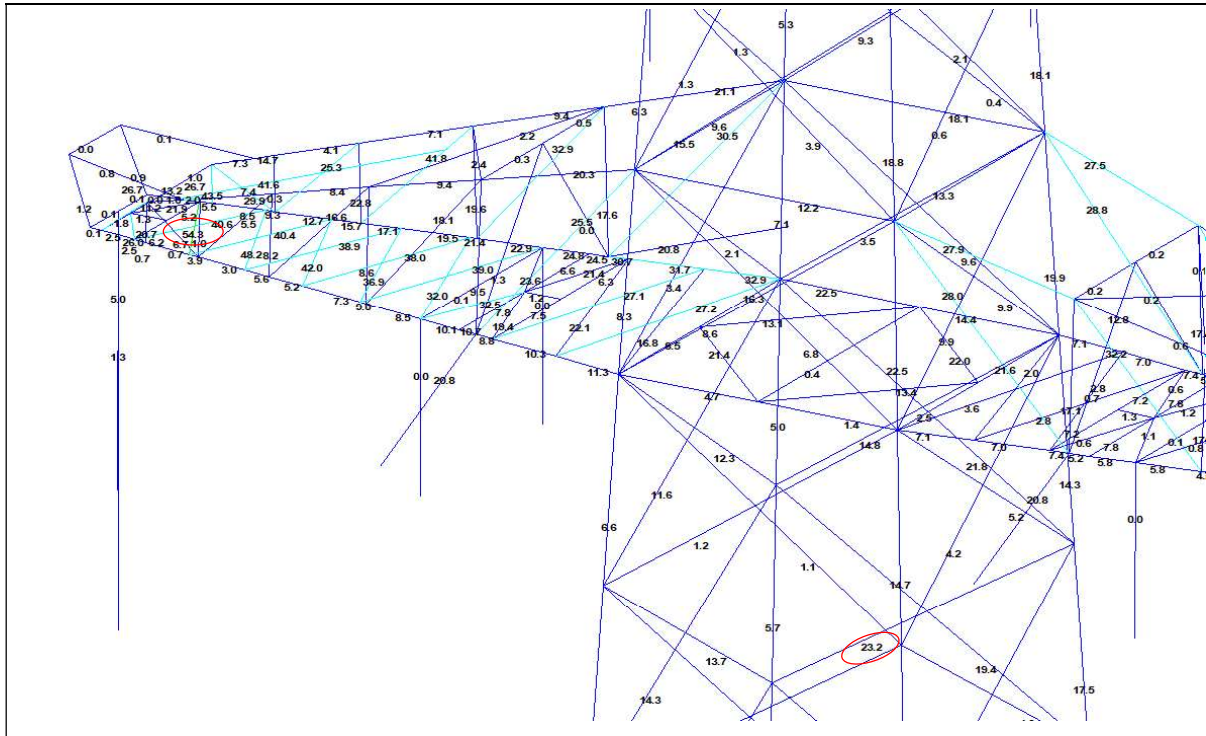

Ondertraverse: $54,3 / 23,2 = 2,34 \geq 1,10$ OK

APPENDIX G

Galloping

Uitgangspunten

In het uitgangspuntendocument is beschreven dat wordt uitgegaan van een materiaalfactor voor vermoeiing $\gamma_{mf} = 1,15$. Dit komt overeen met de “Safe-life methode” met “Low consequence” van tabel 3.1 van NEN-EN 1993-1-9 of met “Damage tolerant” en “High consequence”.

Assessment method	Consequence of failure	
	Low consequence	High consequence
Damage tolerant	1,00	1,15
Safe life	1,15	1,35

Voor staven met gatverzwakking met bouten in ruime gaten geldt volgens fig. 8.1 van NEN-EN 1993-1-9 categorie 50, met $m=3$



Voor niet voorgespannen bouten belast op afschuiving geldt volgens fig. 8.1 van NEN-EN 1993-1-9 categorie 100, met $m=5$.

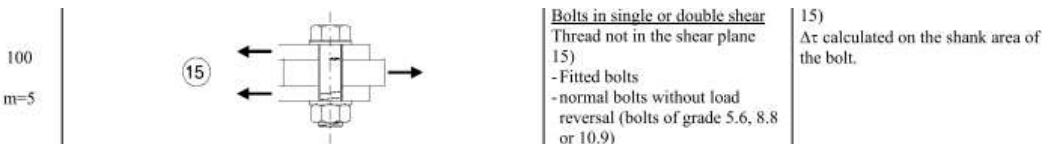

Het belastingspectrum is in de NNA (NEN-EN 50341-2-15) als volgt gedefinieerd.

Table 4.11/NL.1 Load spectra line galloping for tension supports

Load spectra line galloping for tension supports		Number of load cycles in 50 years	
Number	Peak-to-peak load	Ice region A	Ice region B
1	2·EDS	7.000	3.000
2	1,5·EDS	36.000	17.000
3	1,0·EDS	125.000	65.000
4	0,5·EDS	482.000	265.000

Aanpak

De vier belastingen van 0,5 tot 2,0EDS hebben een vaste onderlinge verhouding. Aangezien het aantal wisselingen zich in het $m=3$ gebied van de vermoeiingskromme bevindt vanwege $n < 2 \times 10^6$, kan een relatie worden afgeleid tussen de grootte van de spanningswissel met bijvoorbeeld 1,0EDS en de spanningswisseling die bij 2×10^6 wisselingen op basis van het spectrum nog net toelaatbaar is. Dit staat bekend als de equivalente spanningen methode. Via de factor lambda kan de spanningswisseling worden berekend.

$$\lambda = \left[\frac{\sum \Delta\sigma_i^m \cdot n_i}{2 \cdot 10^6} \right]^{\frac{1}{m}}$$

Toepassen van de formule voor een spanning van 1 N/mm² bij 1,0EDS levert:

Helling Ijsgebied Wisseling	m=3		m=5	
	A	B	A	B
	$\sigma_i^m \times n_i$	$\sigma_i^m \times n_i$	$\sigma_i^m \times n_i$	$\sigma_i^m \times n_i$
2,0EDS	5,60E+04	2,40E+04	2,24E+05	9,60E+04
1,5EDS	1,22E+05	5,74E+04	2,73E+05	1,29E+05
1,0EDS	1,25E+05	6,50E+04	1,25E+05	6,50E+04
0,5EDS	6,03E+04	3,31E+04	1,51E+04	8,28E+03
$\Sigma \sigma_i^m \times n_i$	3,63E+05	1,80E+05	6,37E+05	2,98E+05
$\lambda = (\Sigma \sigma_i n_i / 2 \times 10^6)^{1/m}$	0,57	0,45	0,80	0,68

Voor ijsgebied A is de toelaatbare spanningswisseling bij 1,0 EDS en 125.000 wisselingen dus 1/0,57 (175%) van de toelaatbare spanningswisseling bij een aantal wisselingen van $2,0 \times 10^6$. Er kan ook worden gesteld dat als de spanningswisselingen van 1,0 EDS 363.000 maal voorkomen, dezelfde schade wordt behaald als de vier niveaus afzonderlijk. Deze aanpak is gehanteerd.

- In de berekening van de mast wordt telkens één afspanpunt van de geleiders belast met een trekkracht in lijnrichting van 1,0 EDS.
- Het aantal wisselingen dat deze trekkracht voorkomt wordt vergroot om het hele spectrum te vervangen, dit is afhankelijk van ijsgebied en m-factor.
- Voor iedere staaf in de constructie wordt de schade berekend als gevolg van de trekkracht voor elke geleider.
- De schade wordt gesommeerd over alle geleiders.
- De toetsing is uitgedrukt als de verhouding tussen de optredende spanningswisseling bij $n = 2 \times 10^6$ wisselingen en de toelaatbare spanningswisseling (43 MPa voor het staalprofiel en 87 MPa voor de bout).

Resultaten

In de tabellen zijn de resultaten van mast HA+6/c gegeven. Vanwege de exponentiële invloed van het spanningsniveau heeft de verdeling van de U.C.'s een grote variatie. Het meest zwaar belast zijn de diagonalen in het ondervlak van de traverse in de nabijheid van de afspanpunten en de randen van de traverse. De conclusie is dat de staven en bouten voldoen.



Check galloping

Datum: 16-6-2021
 Auteur: TBR
 Versie: 1.0

RLI-TBG
 HA/c

Group	Omschrijving	Profiel	Aantal bouten	Bout	Controle netto oppervlak profiel					Controle boutdoorsnede							
					ΔF;o [kN]	Brutto [mm2]	Netto [mm2]	Δσ;i;o [Mpa]	DC;o [Mpa]	Δσ;c;o [Mpa]	opp. [kN]	ΔF;i;b [mm2]	Bout [mm2]	Δσ;i;b [Mpa]	DC;b [Mpa]	Δσ;c;b [Mpa]	UC bout
100	Main leg	80x80x8	2	M20	14.1	1230	1054	13.4	50	43	0.31	21.5	314	34.2	100	87	0.39
101	Main leg	130x130x12	4	M24	22.7	3000	2688	8.5	50	43	0.19	34.3	452	19.0	100	87	0.22
102	Main leg	160x160x15	6	M24	39.1	4671	4281	9.1	50	43	0.21	56.7	452	20.9	100	87	0.24
103	Main leg	160x160x15	8	M24	57.9	4671	4281	13.5	50	43	0.31	85.7	452	23.7	100	87	0.27
104	Main leg	160x160x15	8	M24	73.3	4671	4281	17.1	50	43	0.39	103.9	452	28.7	100	87	0.33
105	Main leg	200x200x24	8	M24	104.0	9060	8436	12.3	50	43	0.28	151.8	452	42.0	100	87	0.48
106	Main leg	200x200x24	0		127.9	9060	9060	14.1	50	43	0.32	185.6	0	0.0	100	87	0.00
107	Main leg	200x200x24	12	M24	136.4	9060	8436	16.2	50	43	0.37	193.6	452	35.7	100	87	0.41
108	Main leg	200x200x24	20	M24	163.2	9060	8436	19.3	50	43	0.44	227.7	452	25.2	100	87	0.29
109	Main leg	200x200x24	20	M24	177.9	9060	8436	21.1	50	43	0.48	246.7	452	27.3	100	87	0.31
110	Main leg	250x250x24	24	M24	195.0	11492	10868	17.9	50	43	0.41	268.3	452	24.7	100	87	0.28
111	Main leg	250x250x24	24	M24	204.8	11492	10868	18.8	50	43	0.43	278.5	452	25.7	100	87	0.30
112.3	Main leg	250x250x24	24	M24	221.5	11492	10868	20.4	50	43	0.47	299.5	452	27.6	100	87	0.32
113.3	Main leg	250x250x20	0		178.0	9700	9700	18.4	50	43	0.42	234.0	0	0.0	100	87	0.00
114.3	Main leg	250x250x24	24	M24	177.7	11492	10868	16.4	50	43	0.38	233.6	452	21.5	100	87	0.25
200	Diag front face	100x100x10	2	M24	17.3	1920	1660	10.4	50	43	0.24	26.4	452	29.2	100	87	0.34
201	Diag front face	150x150x14	6	M24	101.5	4014	3650	27.8	50	43	0.64	153.2	452	56.5	100	87	0.65
202	Diag front face	150x150x14	5	M24	84.9	4014	3650	23.3	50	43	0.54	128.1	452	56.7	100	87	0.65
203	Diag front face	150x150x14	5	M24	74.7	4014	3650	20.5	50	43	0.47	112.7	452	49.9	100	87	0.57
204	Diag front face	120x120x12(12,0,33)	4	M24	101.0	5500	5188	19.5	50	43	0.45	144.0	452	79.7	100	87	0.92
205	Diag front face	120x120x12(12,0,33)	4	M24	87.8	5500	5188	16.9	50	43	0.39	125.4	452	69.3	100	87	0.80
206	Diag front face	120x120x12(12,0,33)	4	M24	80.5	5500	5188	15.5	50	43	0.36	112.2	452	62.1	100	87	0.71
207	Diag front face	120x120x12(12,0,33)	3	M24	74.1	5500	5188	14.3	50	43	0.33	98.1	452	54.2	100	87	0.62
208	Diag front face	120x120x12(12,0,33)	3	M24	66.0	5500	5188	12.7	50	43	0.29	87.4	452	64.4	100	87	0.74
209	Diag front face	120x120x12(12,0,33)	3	M24	62.1	5500	5188	12.0	50	43	0.28	82.0	452	60.5	100	87	0.70
210	Diag front face	120x120x12(12,0,33)	3	M24	61.3	5500	5188	11.8	50	43	0.27	80.8	452	59.6	100	87	0.69
211.3	Diag front face	150x150x15(15,0,33)	3	M24	41.7	6970	6658	6.3	50	43	0.14	55.5	452	40.9	100	87	0.47
212.3	Diag front face	130x130x12(15,0,33)	3	M24	31.0	6040	5728	5.4	50	43	0.12	41.2	452	30.4	100	87	0.35
213.3	Diag front face	160x160x15(14,0,33)	5	M24	32.9	9342	8952	3.7	50	43	0.08	43.8	452	19.4	100	87	0.22
214.3	Diag front face	150x150x12(12,0,33)	4	M24	58.9	6970	6658	8.8	50	43	0.20	78.3	452	43.3	100	87	0.50
300	Diag side face	80x80x8	2	M24	13.9	1230	1022	13.6	50	43	0.31	21.2	452	23.4	100	87	0.27
301	Diag side face	150x150x14	6	M24	107.1	4014	3650	29.3	50	43	0.67	161.8	452	59.7	100	87	0.69
302	Diag side face	150x150x14	5	M24	89.9	4014	3650	24.0	50	43	0.57	135.8	452	60.1	100	87	0.69
303	Diag side face	150x150x14	4	M24	72.9	4014	3650	20.0	50	43	0.46	110.2	452	60.9	100	87	0.70
304	Diag side face	120x120x12(12,0,33)	4	M24	97.8	5500	5188	18.9	50	43	0.43	136.0	452	75.2	100	87	0.86
305	Diag side face	120x120x12(12,0,33)	4	M24	85.6	5500	5188	16.5	50	43	0.38	118.9	452	65.8	100	87	0.76
306	Diag side face	120x120x12(12,0,33)	3	M24	76.5	5500	5188	14.8	50	43	0.34	106.3	452	78.4	100	87	0.90
307	Diag side face	120x120x12(12,0,33)	3	M24	85.7	5500	5188	16.5	50	43	0.38	113.7	452	62.9	100	87	0.72
308	Diag side face	120x120x12(12,0,33)	3	M24	78.4	5500	5188	15.1	50	43	0.35	104.0	452	76.7	100	87	0.88
309	Diag side face	120x120x12(12,0,33)	3	M24	74.0	5500	5188	14.3	50	43	0.33	98.1	452	72.4	100	87	0.83
310	Diag side face	120x120x12(12,0,33)	3	M24	69.3	5500	5188	13.4	50	43	0.31	91.9	452	67.8	100	87	0.78

Check galloping

Datum: 16-6-2021
 Auteur: TBR
 Versie: 1.0

RLI-TBG
 HA/c

Group	Omschrijving	Profiel	Aantal bouten	Bout	Controle netto oppervlak profiel										Controle boutdoorsnede					
					ΔF;o [kN]	Brutto [mm2]	Netto [mm2]	Δσ;i;0 [Mpa]	DC;o [Mpa]	Δσ;c;o [Mpa]	UC opp.	ΔF;i;b [kN]	Bout [mm2]	Δσ;i;b [Mpa]	DC;b [Mpa]	Δσ;c;b [Mpa]	UC bout			
311.3	Diag side face	150x150x12(12,0,0.33)	3	M24	53.8	6970	6658	8.1	50	43	0.19	452	53.1	100	87	0.61				
312.3	Diag side face	130x130x12#(15,0,0.33)	3	M24	39.1	6040	5728	6.8	50	43	0.16	452	38.6	100	87	0.44				
313.3	Diag side face	160x160x15#(14,0,0.33)	5	M24	40.4	9342	8952	4.5	50	43	0.10	452	23.9	100	87	0.28				
314.3	Diag front face	150x150x12(12,0,0.33)	4	M24	74.2	6970	6658	11.1	50	43	0.26	452	54.9	100	87	0.63				
400	Horizontal lower ca.	180x180x16	10	M24	69.2	5540	5124	13.5	50	43	0.31	452	23.3	100	87	0.27				
401	Lower chord lower ca.	150x150x14	10	M24	132.4	4014	3650	36.3	50	43	0.83	452	44.7	100	87	0.51				
402	Lower chord lower ca.	150x150x14	0		117.6	4014	4014	29.3	50	43	0.67	179.5	0	0.0	100	87	0.00			
403	Lower chord lower ca.	150x150x14	0		104.5	4014	4014	26.0	50	43	0.60	159.5	0	0.0	100	87	0.00			
404	Lower chord lower ca.	150x150x14	0		76.7	4014	4014	19.1	50	43	0.44	117.2	0	0.0	100	87	0.00			
405	Lower chord lower ca.	150x150x14	0		47.0	4014	4014	11.7	50	43	0.27	71.8	0	0.0	100	87	0.00			
406	Lower chord lower ca.	150x150x14	0		26.3	4014	4014	6.6	50	43	0.15	40.1	0	0.0	100	87	0.00			
407	Lower chord lower ca.	150x150x14	0		0.4	4014	4014	0.1	50	43	0.00	0	0.0	100	87	0.00				
410	Horizontal lower ca.	130x130x12	3	M24	19.5	3000	2688	7.3	50	43	0.17	29.5	452	21.7	100	87	0.25			
411	Horizontal lower ca.	150x150x14 (not coup)	2	M24	13.3	8028	7664	1.7	50	43	0.04	20.3	452	22.5	100	87	0.26			
412	Horizontal lower ca.	HEA140	0		0.6	3140	3140	0.2	50	43	0.00	0	0.0	100	87	0.00				
413	Horizontal lower ca.	150x150x18 (not coup)	2	M24	27.1	10200	9732	2.8	50	43	0.06	41.4	452	45.8	100	87	0.53			
414	Beam lower ca.	HEB220	0		1.7	9104	9104	0.2	50	43	0.00	2.7	0	0.0	100	87	0.00			
415	Horizontal lower ca.	100x100x10	0		4.6	3740	3740	1.2	50	43	0.03	7.0	0	0.0	100	87	0.00			
426	Upper chord lower ca.	100x100x10	4	M24	11.4	1920	1660	6.9	50	43	0.16	17.2	452	9.5	100	87	0.11			
427	Upper chord lower ca.	100x100x10	0		10.4	1920	1920	5.4	50	43	0.12	15.7	0	0.0	100	87	0.00			
428	Upper chord lower ca.	100x100x10	0		10.8	1920	1920	5.6	50	43	0.13	16.3	0	0.0	100	87	0.00			
429	Upper chord lower ca.	100x100x10	0		11.6	1920	1920	6.0	50	43	0.14	17.5	0	0.0	100	87	0.00			
430	Upper chord lower ca.	100x100x10	4	M20	11.6	1920	1700	6.8	50	43	0.16	17.5	314	14.0	100	87	0.16			
431	Upper chord lower ca.	100x100x10	2	M20	15.5	1920	1700	9.1	50	43	0.21	23.3	314	37.1	100	87	0.43			
433	Stability bracing lower ca.	70x70x6	1	M16	0.2	810	702	0.3	50	43	0.01	0.3	201	1.4	100	87	0.02			
434	Hand rail	60x60x6	0		0.1	690	690	0.1	50	43	0.00	0.1	0	0.0	100	87	0.00			
435	Hand rail	60x60x6	0		0.0	690	690	0.0	50	43	0.00	0	0.0	100	87	0.00				
436	Hand rail	60x60x6	0		0.0	690	690	0.1	50	43	0.00	0.1	0	0.0	100	87	0.00			
437	Stability bracing lower ca.	70x70x6	1	M16	0.6	810	702	0.8	50	43	0.02	0.8	201	4.2	100	87	0.05			
440	Vertical side face lower ca.	70x70x6	1	M16	1.9	810	702	2.7	50	43	0.06	2.8	201	14.1	100	87	0.16			
441	Vertical side face lower ca.	70x70x6	1	M16	2.5	810	702	3.5	50	43	0.08	3.8	201	18.9	100	87	0.22			
442	Vertical side face lower ca.	60x60x6	1	M16	3.3	690	582	5.6	50	43	0.13	5.0	201	24.9	100	87	0.29			
443	Vertical side face lower ca.	60x60x6	1	M16	0.2	690	582	0.3	50	43	0.01	0.3	201	1.4	100	87	0.02			
444	Vertical side face lower ca.	60x60x6	1	M16	9.2	690	582	15.9	50	43	0.36	14.0	201	69.9	100	87	0.80			
460	Diag side face lower ca.	80x80x6	2	M16	4.7	940	832	5.6	50	43	0.13	7.0	201	17.4	100	87	0.20			
461	Diag side face lower ca.	60x60x6	1	M16	3.1	690	582	5.4	50	43	0.12	4.8	201	23.7	100	87	0.27			
462	Diag side face lower ca.	60x60x6	1	M16	5.0	690	582	8.6	50	43	0.20	7.6	201	37.9	100	87	0.44			
463	Diag side face lower ca.	60x60x6	1	M16	6.7	690	582	11.5	50	43	0.26	10.2	201	25.4	100	87	0.29			
464	Diag side face lower ca.	60x60x6	2	M16	9.3	690	582	16.0	50	43	0.37	14.2	201	35.4	100	87	0.41			
465	Stability bracing lower ca.	90x90x9	1	M16	0.3	1539	1377	0.2	50	43	0.00	0.4	201	2.0	100	87	0.02			
475	Diag lower plane lower ca.	80x80x6	2	M20	13.8	940	808	17.1	50	43	0.39	19.3	314	30.7	100	87	0.35			

Check galloping

Datum: 16-6-2021
 Auteur: TBR
 Versie: 1.0

RLI-TBG
 HA/c

Group	Omschrijving	Profiel	Aantal bouten	Bout	Controle netto oppervlak profiel					Controle boutdoorsnede							
					ΔF_o [kN]	Brutto [mm ²]	Netto [mm ²]	$\Delta \sigma_o$ [Mpa]	DC _o [Mpa]	$\Delta \sigma_c$ [Mpa]	opp. [kN]	ΔF_b [kN]	Bout [mm ²]	$\Delta \sigma_b$ [Mpa]	DC _b [Mpa]	$\Delta \sigma_c$ [Mpa]	UC bout
476	Diag lower plane lower ca.	80x80x6	2	M20	16.2	940	808	20.0	50	43	0.46	17.0	314	35.8	100	87	0.41
477	Diag lower plane lower ca.	80x80x6	2	M20	11.4	940	808	14.1	50	43	0.32	17.0	314	27.0	100	87	0.31
478	Diag lower plane lower ca.	80x80x6	2	M20	14.1	940	808	17.5	50	43	0.40	21.6	314	34.4	100	87	0.40
479	Diag lower plane lower ca.	70x70x6	2	M16	15.6	810	702	22.2	50	43	0.51	23.7	201	59.1	100	87	0.68
480	Diag lower plane lower ca.	70x70x6	2	M20	17.5	810	678	25.8	50	43	0.59	26.7	314	42.5	100	87	0.49
481	Diag lower plane lower ca.	70x70x6	2	M20	20.1	810	678	29.6	50	43	0.68	30.7	314	48.8	100	87	0.56
482	Diag lower plane lower ca.	70x70x6	2	M20	23.5	810	678	34.6	50	43	0.80	35.8	314	57.0	100	87	0.66
483	Diag lower plane lower ca.	70x70x6	2	M20	26.1	810	678	38.5	50	43	0.88	39.8	314	63.4	100	87	0.73
484	Diag lower plane lower ca.	70x70x6	2	M16	12.1	810	702	17.2	50	43	0.40	18.5	201	46.0	100	87	0.53
485	Plan bracing lower ca.	120x120x10	3	M24	25.1	2320	2060	12.2	50	43	0.28	37.7	452	27.8	100	87	0.32
486	Plan bracing lower ca.	120x120x10	4	M24	0.0	2320	2060	0.0	50	43	0.00	0.1	452	0.0	100	87	0.00
500	Horizontal mid ca.	200x200x18	10	M24	121.8	6910	6442	18.9	50	43	0.43	185.0	452	40.9	100	87	0.47
501	Lower chord mid ca.	180x180x18	10	M24	206.0	6190	5722	36.0	50	43	0.83	312.9	452	69.2	100	87	0.80
502	Lower chord mid ca.	180x180x18	0	0	199.3	6190	6190	32.2	50	43	0.74	303.1	0	0.0	100	87	0.00
503	Lower chord mid ca.	180x180x18	0	0	181.8	6190	6190	29.4	50	43	0.68	277.3	0	0.0	100	87	0.00
504	Lower chord mid ca.	180x180x18	8	M24	159.7	6190	5722	27.9	50	43	0.64	243.8	452	67.4	100	87	0.78
505	Lower chord mid ca.	160x160x15	8	M24	136.5	4671	4281	31.9	50	43	0.73	208.4	452	57.6	100	87	0.66
506	Lower chord mid ca.	160x160x15	0	0	97.7	4671	4671	20.9	50	43	0.48	149.2	0	0.0	100	87	0.00
507	Lower chord mid ca.	160x160x15	0	0	62.8	4671	4671	13.4	50	43	0.31	95.9	0	0.0	100	87	0.00
508	Lower chord mid ca.	160x160x15	0	0	31.2	4671	4671	6.7	50	43	0.15	47.5	0	0.0	100	87	0.00
509	Lower chord mid ca.	160x160x15	2	M20	0.3	4671	4341	0.1	50	43	0.00	0.4	314	0.7	100	87	0.01
511	Horizontal mid ca.	150x150x12	3	M24	36.7	3480	3168	11.6	50	43	0.27	55.9	452	41.2	100	87	0.47
512	Beam mid ca.	150x150x14 (not coup)	2	M24	16.1	8028	7664	2.1	50	43	0.05	22.4	452	24.8	100	87	0.29
513	Horizontal mid ca.	HEA140	0	0	0.2	3140	3140	0.1	50	43	0.00	0.3	0	0.0	100	87	0.00
514	Beam mid ca.	150x150x18 (not coup)	2	M24	25.9	10200	9732	2.7	50	43	0.06	39.6	452	43.8	100	87	0.50
515	Horizontal mid ca.	HEB220	0	0	2.3	9104	9104	0.3	50	43	0.01	3.6	0	0.0	100	87	0.00
516	Beam mid ca.	UNP220	0	0	7.0	3740	3740	1.9	50	43	0.04	10.7	0	0.0	100	87	0.00
526	Upper chord mid ca.	120x120x12	4	M24	28.5	2750	2438	11.7	50	43	0.27	43.1	452	23.8	100	87	0.27
527	Upper chord mid ca.	120x120x12	0	0	28.7	2750	2750	10.4	50	43	0.24	43.5	0	0.0	100	87	0.00
528	Upper chord mid ca.	120x120x12	6	M24	27.5	2750	2438	11.3	50	43	0.26	41.8	452	15.4	100	87	0.18
529	Upper chord mid ca.	100x100x10	6	M24	25.4	1920	1660	15.3	50	43	0.35	38.7	452	14.3	100	87	0.16
530	Upper chord mid ca.	100x100x10	0	0	24.0	1920	1920	12.5	50	43	0.29	36.5	0	0.0	100	87	0.00
531	Upper chord mid ca.	100x100x10	0	0	22.5	1920	1920	11.7	50	43	0.27	34.2	0	0.0	100	87	0.00
532	Upper chord mid ca.	100x100x10	4	M24	22.5	1920	1660	13.6	50	43	0.31	34.2	452	18.9	100	87	0.22
533	Upper chord mid ca.	100x100x10	2	M24	25.5	1920	1660	15.3	50	43	0.35	38.7	452	42.8	100	87	0.49
535	Stability bracing mid ca.	70x70x6	1	M16	0.4	810	702	0.6	50	43	0.01	0.6	201	2.9	100	87	0.03
536	Hand rail	60x60x6	0	0	0.1	690	690	0.1	50	43	0.00	0.1	0	0.0	100	87	0.00
537	Hand rail	60x60x6	0	0	0.0	690	690	0.0	50	43	0.00	0.0	0	0.0	100	87	0.00
538	Hand rail	60x60x6	0	0	0.0	690	690	0.0	50	43	0.00	0.0	0	0.0	100	87	0.00
539	Stability bracing mid ca.	70x70x6	1	M16	1.2	810	702	1.7	50	43	0.04	1.6	201	8.2	100	87	0.09
540	Vertical side face mid ca.	80x80x6	1	M16	2.7	940	832	3.3	50	43	0.08	3.8	201	19.2	100	87	0.22

Check galloping

Datum: 16-6-2021
 Auteur: TBR
 Versie: 1.0

RLI-TBG
 HA/c

Group	Omschrijving	Profiel	Aantal bouten	Bout	Controle netto oppervlak profiel										Controle boutdoorsnede									
					ΔF;o [kN]	Brutto [mm2]	Netto [mm2]	Δσ;i;o [Mpa]	DC;o [Mpa]	Δσ;c;o [Mpa]	UC opp. [Mpa]	UC ΔF;i;b [kN]	Bout [mm2]	Δσ;i;b [Mpa]	DC;b [Mpa]	Δσ;c;b [Mpa]	UC bout [Mpa]							
541	Vertical side face mid ca.	80x80x6	1	M16	2.7	940	832	3.2	50	43	0.07	3.9	201	19.6	100	87	0.22							
542	Vertical side face mid ca.	60x60x6	1	M16	1.4	690	582	2.5	50	43	0.06	2.2	201	10.9	100	87	0.12							
543	Vertical side face mid ca.	60x60x6	1	M16	2.1	690	582	3.6	50	43	0.08	3.2	201	15.9	100	87	0.18							
544	Vertical side face mid ca.	60x60x6	1	M16	2.5	690	582	4.3	50	43	0.10	3.8	201	18.9	100	87	0.22							
545	Vertical side face mid ca.	60x60x6	1	M16	0.3	690	582	0.6	50	43	0.01	0.5	201	2.5	100	87	0.03							
546	Vertical side face mid ca.	60x60x6	2	M16	11.1	690	582	19.1	50	43	0.44	17.0	201	42.2	100	87	0.49							
560	Diag side face mid ca.	80x80x6	2	M16	2.4	940	832	2.9	50	43	0.07	3.7	201	9.1	100	87	0.10							
561	Diag side face mid ca.	70x70x6	2	M16	4.1	810	702	5.9	50	43	0.14	5.8	201	14.5	100	87	0.17							
562	Diag side face mid ca.	60x60x6	2	M16	4.3	690	582	7.3	50	43	0.17	6.2	201	15.5	100	87	0.18							
563	Diag side face mid ca.	60x60x6	1	M16	2.5	690	582	4.3	50	43	0.10	3.8	201	19.0	100	87	0.22							
564	Diag side face mid ca.	60x60x6	2	M16	4.4	690	582	7.6	50	43	0.17	6.7	201	16.8	100	87	0.19							
565	Diag side face mid ca.	60x60x6	2	M16	5.2	690	582	9.0	50	43	0.21	8.0	201	19.9	100	87	0.23							
566	Diag side face mid ca.	60x60x6	2	M16	6.4	690	582	10.9	50	43	0.25	9.7	201	24.1	100	87	0.28							
567	Stability bracing mid ca.	70x70x6	1	M16	0.7	810	702	0.9	50	43	0.02	0.9	201	4.4	100	87	0.05							
575	Diag lower plane mid ca.	70x70x6	2	M20	11.0	810	678	16.2	50	43	0.37	15.3	314	24.4	100	87	0.28							
576	Diag lower plane mid ca.	70x70x6	2	M20	13.6	810	678	20.0	50	43	0.46	18.9	314	30.1	100	87	0.35							
577	Diag lower plane mid ca.	70x70x6	2	M20	14.2	810	678	21.0	50	43	0.48	19.9	314	31.6	100	87	0.36							
578	Diag lower plane mid ca.	70x70x6	2	M20	15.6	810	678	23.0	50	43	0.53	21.8	314	34.8	100	87	0.41							
579	Diag lower plane mid ca.	70x70x6	2	M20	16.0	810	678	23.5	50	43	0.54	22.3	314	35.4	100	87	0.35							
580	Diag lower plane mid ca.	70x70x6	2	M20	12.9	810	678	19.0	50	43	0.44	19.3	314	30.7	100	87	0.44							
581	Diag lower plane mid ca.	70x70x6	2	M20	15.7	810	678	23.1	50	43	0.53	23.9	314	38.1	100	87	0.47							
582	Diag lower plane mid ca.	70x70x6	2	M20	16.8	810	678	24.7	50	43	0.57	25.6	314	40.8	100	87	0.53							
583	Diag lower plane mid ca.	70x70x6	2	M20	19.1	810	678	28.2	50	43	0.65	29.2	314	46.5	100	87	0.61							
584	Diag lower plane mid ca.	70x70x6	2	M20	21.7	810	678	32.0	50	43	0.74	33.1	314	52.7	100	87	0.74							
585	Diag lower plane mid ca.	80x80x6	2	M20	26.4	940	808	32.6	50	43	0.75	40.2	314	64.1	100	87	0.82							
586	Diag lower plane mid ca.	80x80x6	2	M20	29.2	940	808	36.2	50	43	0.83	44.6	314	71.0	100	87	0.82							
587	Diag lower plane mid ca.	60x60x6	2	M16	11.6	690	582	19.9	50	43	0.46	17.7	201	44.0	100	87	0.51							
588	Plan bracing mid ca.	140x140x13	5	M24	88.8	3521	3183	27.9	50	43	0.64	135.1	452	59.8	100	87	0.69							
589	Plan bracing mid ca.	150x150x12	4	M24	57.0	3480	3168	18.0	50	43	0.41	86.7	452	48.0	100	87	0.55							
600	Horizontal top ca.	200x200x18	10	M24	132.2	6910	6442	20.5	50	43	0.47	199.8	452	44.2	100	87	0.51							
601	Lower chord top ca.	180x180x18	8	M24	172.3	6190	5722	30.1	50	43	0.69	262.8	452	72.7	100	87	0.84							
602	Lower chord top ca.	180x180x18	6	M24	142.9	6190	5722	25.0	50	43	0.57	218.1	452	80.4	100	87	0.92							
603	Lower chord top ca.	150x150x14	6	M24	106.2	4014	3650	29.1	50	43	0.67	162.1	452	59.8	100	87	0.69							
604	Lower chord top ca.	150x150x14	0		50.0	4014	4014	12.5	50	43	0.29	76.3	0	0.0	100	87	0.00							
605	Lower chord top ca.	150x150x14	2	M20	23.6	4014	3706	6.4	50	43	0.15	35.7	314	56.8	100	87	0.65							
606	Lower chord top ca.	150x150x14	2	M20	4.6	4014	3706	1.2	50	43	0.03	6.6	314	10.5	100	87	0.12							
608	Earth peak lower chord	80x80x8	2	M20	6.2	1230	1054	5.9	50	43	0.13	8.9	314	14.1	100	87	0.16							
609	Earth peak lower chord	80x80x8	2	M20	5.3	1230	1054	5.0	50	43	0.11	7.4	314	11.8	100	87	0.14							
610	Horizontal top ca.	130x130x12	3	M24	38.6	3000	2688	14.3	50	43	0.33	57.7	452	42.5	100	87	0.49							
611	Horizontal top ca.	150x150x14 (not coup	2	M24	13.5	8028	7664	1.8	50	43	0.04	20.7	452	22.9	100	87	0.26							
612	Horizontal top ca.	HEA140	0		0.7	3140	3140	0.2	50	43	0.00	0.9	0	0.0	100	87	0.00							

Check galloping

Datum: 16-6-2021
 Auteur: TBR
 Versie: 1.0

RLI-TBG
 HA/c

Group	Omschrijving	Profiel	Aantal bouten	Bout	Controle netto oppervlak profiel					Controle boutdoorsnede							
					ΔF_o [kN]	Brutto [mm ²]	Netto [mm ²]	$\Delta \sigma_o$ [Mpa]	DC _o [Mpa]	$\Delta \sigma_c$ [Mpa]	UC opp.	ΔF_b [kN]	Bout [mm ²]	$\Delta \sigma_b$ [Mpa]	DC _b [Mpa]	$\Delta \sigma_c$ [Mpa]	UC bout
613	Horizontaal top ca.	150x150x18 (not coup)		2	26.6	10200	9732	2.7	50	43	0.06	40.6	452	44.9	100	87	0.52
614	Beam top ca.	HEB220		0	1.8	9104	9104	0.2	50	43	0.00	2.8	0	0.0	100	87	0.00
615	Earth peak horizontal	60x60x6		1	0.8	690	582	1.4	50	43	0.03	1.2	201	5.8	100	87	0.07
616	Earth peak horizontal	60x60x6		1	0.8	690	582	1.4	50	43	0.03	1.2	201	5.9	100	87	0.07
617	Earth peak horizontal	60x60x6		1	0.0	690	582	0.0	50	43	0.00	0.0	201	0.1	100	87	0.00
618	Beam top ca.	UNP220		0	4.5	3740	3740	1.2	50	43	0.03	6.8	0	0.0	100	87	0.00
626	Upper chord top ca.	120x120x12		4	36.9	2750	2438	15.2	50	43	0.35	56.3	452	31.2	100	87	0.36
627	Upper chord top ca.	100x100x10		3	15.1	1920	1660	9.1	50	43	0.21	22.8	452	16.8	100	87	0.19
628	Upper chord top ca.	100x100x10		6	14.5	1920	1660	8.8	50	43	0.20	22.1	452	8.1	100	87	0.09
629	Upper chord top ca.	100x100x10		3	14.8	1920	1660	8.9	50	43	0.21	22.6	452	16.7	100	87	0.19
630	Earth peak upper chord	130x130x12		0	53.7	3000	3000	17.9	50	43	0.41	73.4	0	0.0	100	87	0.00
631	Earth peak upper chord	130x130x12		4	47.0	3000	2688	17.5	50	43	0.40	66.0	452	36.5	100	87	0.42
632	Earth peak upper chord	120x120x10		4	44.5	2320	2060	21.6	50	43	0.50	62.5	452	34.5	100	87	0.40
633	Earth peak upper chord	120x120x10		0	38.6	2320	2320	16.6	50	43	0.38	54.2	0	0.0	100	87	0.00
634	Earth peak upper chord	120x120x10		0	30.0	2320	2320	12.9	50	43	0.30	42.1	0	0.0	100	87	0.00
635	Earth peak upper chord	120x120x10		2	16.1	2320	2100	7.7	50	43	0.18	22.6	314	35.9	100	87	0.41
637	Stability bracing top ca.	70x70x7		1	8.9	940	814	10.9	50	43	0.25	13.4	201	66.6	100	87	0.77
638	Earth peak horizontal	UNP160		2	4.7	2400	2235	2.1	50	43	0.05	6.6	314	10.5	100	87	0.12
640	Vertical side face top ca.	60x60x6		2	3.5	690	582	6.0	50	43	0.14	5.0	201	12.4	100	87	0.14
641	Vertical side face top ca.	60x60x6		2	13.3	690	582	22.9	50	43	0.53	20.1	201	50.0	100	87	0.57
642	Vertical side face top ca.	80x80x6		1	2.9	940	832	3.5	50	43	0.08	4.3	201	21.4	100	87	0.25
643	Vertical side face top ca.	80x80x6		1	0.2	940	832	0.3	50	43	0.01	0.3	201	1.7	100	87	0.02
644	Vertical side face top ca.	80x80x6		1	0.1	1230	1086	0.1	50	43	0.00	0.2	201	0.8	100	87	0.01
645	Vertical side face top ca.	80x80x8		1	0.2	690	582	0.4	50	43	0.01	0.3	201	1.5	100	87	0.02
646	Earth peak vertical side face	60x60x6		2	5.0	810	702	7.1	50	43	0.16	6.9	201	17.1	100	87	0.20
660	Diag side face top ca.	70x70x6		2	4.9	1230	1086	4.5	50	43	0.10	7.3	201	18.1	100	87	0.21
661	Diag side face top ca.	70x70x6		2	6.1	810	702	8.7	50	43	0.20	9.1	201	22.7	100	87	0.26
662	Diag side face top ca.	80x80x6		1	0.2	940	832	0.2	50	43	0.00	0.2	201	1.2	100	87	0.01
663	Earth peak diag side face	80x80x6		2	16.8	1230	1086	15.5	50	43	0.36	25.4	201	63.1	100	87	0.73
664	Stability bracing top ca.	60x60x6		2	7.5	690	582	12.9	50	43	0.30	10.5	201	26.2	100	87	0.30
673	Earth peak diag upper side	60x60x6		2	5.8	690	582	10.0	50	43	0.23	8.2	201	20.3	100	87	0.23
674	Earth peak diag upper side	60x60x6		2	13.3	810	678	19.6	50	43	0.45	18.5	314	29.5	100	87	0.34
675	Diag lower plane top ca.	70x70x6		2	17.0	810	678	25.0	50	43	0.58	23.8	314	37.9	100	87	0.44
676	Diag lower plane top ca.	70x70x6		2	15.4	810	678	22.8	50	43	0.52	21.6	314	34.4	100	87	0.40
677	Diag lower plane top ca.	70x70x6		2	13.1	810	678	19.4	50	43	0.45	19.9	314	31.7	100	87	0.36
678	Diag lower plane top ca.	70x70x6		2	15.7	810	678	22.3	50	43	0.51	23.0	314	36.7	100	87	0.42
679	Diag lower plane top ca.	70x70x6		2	16.1	810	678	24.6	50	43	0.57	25.4	314	40.4	100	87	0.47
680	Diag lower plane top ca.	70x70x6		2	25.8	810	678	38.0	50	43	0.87	39.3	314	62.6	100	87	0.72
681	Diag lower plane top ca.	70x70x6		2	27.9	810	678	41.2	50	43	0.95	42.7	314	67.9	100	87	0.78
682	Diag lower plane top ca.	80x80x6		2	29.7	940	808	36.8	50	43	0.85	45.4	314	72.3	100	87	0.83

Check galloping

Datum: 16-6-2021
 Auteur: TBR
 Versie: 1.0

RLL-TBG
 HA/c

Group	Omschrijving	Profiel	Aantal bouten	Bout	Controle netto oppervlak profiel					Controle boutdoorsnede							
					ΔF_o [kN]	Brutto [mm ²]	Netto [mm ²]	$\Delta\sigma_{jo}$ [Mpa]	DC _{jo} [Mpa]	$\Delta\sigma_{co}$ [Mpa]	UC opp. [kN]	$\Delta F_{f;b}$ [kN]	Opp. Bout [mm ²]	$\Delta\sigma_{j;b}$ [Mpa]	DC _b [Mpa]	$\Delta\sigma_{c;b}$ [Mpa]	UC bout
684	Diag lower plane top ca.	80x80x6		2 M20	29.4	940	808	36.3	50	43	0.84	44.8	314	71.4	100	87	0.82
685	Diag lower plane top ca.	60x60x6		2 M16	11.3	690	582	19.4	50	43	0.45	17.3	201	42.9	100	87	0.49
686	Earth peak diag lower plane	70x70x7		1 M16	0.4	940	814	0.5	50	43	0.01	0.6	201	2.8	100	87	0.03
687	Earth peak diag lower plane	70x70x7		1 M16	2.3	940	814	2.8	50	43	0.06	3.4	201	16.9	100	87	0.19
688	Earth peak diag upper plane	70x70x6		2 M16	8.3	810	702	11.8	50	43	0.27	12.3	201	30.7	100	87	0.35
689	Earth peak diag upper plane	70x70x6		2 M16	9.1	810	702	13.0	50	43	0.30	13.6	201	33.9	100	87	0.39
690	Earth peak diag upper plane	60x60x6		2 M16	9.8	690	582	16.8	50	43	0.39	14.6	201	36.3	100	87	0.42
691	Earth peak diag upper plane	60x60x6		2 M16	10.7	690	582	18.3	50	43	0.42	15.9	201	39.6	100	87	0.46
692	Earth peak diag upper plane	60x60x6		1 M16	2.3	690	582	3.9	50	43	0.09	3.2	201	16.1	100	87	0.18
693	Earth peak diag upper plane	60x60x6		1 M16	2.5	690	582	4.4	50	43	0.10	3.6	201	17.7	100	87	0.20
694	Earth peak diag upper plane	60x60x6		1 M16	2.8	690	582	4.8	50	43	0.11	3.9	201	19.6	100	87	0.22
695	Earth peak diag upper plane	60x60x6		1 M16	3.2	690	582	5.5	50	43	0.13	4.5	201	22.2	100	87	0.26
696	Earth peak diag upper plane	60x60x6		1 M16	3.8	690	582	6.5	50	43	0.15	5.3	201	26.6	100	87	0.31
697	Earth peak diag upper plane	60x60x6		1 M16	4.6	690	582	7.9	50	43	0.18	6.4	201	32.1	100	87	0.37
698	Plan bracing top ca.	150x150x12		4 M24	56.4	3480	3168	17.8	50	43	0.41	84.7	452	46.9	100	87	0.54
699	Plan bracing top ca.	140x140x13		5 M24	92.5	3521	3183	29.1	50	43	0.67	138.7	452	61.4	100	87	0.71
700.3	Hor. Plan bracing hip structur	120x120x10		2 M20	1.2	2320	2100	0.6	50	43	0.01	1.6	314	2.5	100	87	0.03
701.3	Hor. Plan bracing hip structur	110x110x10		2 M20	0.3	2112	1892	0.2	50	43	0.00	0.4	314	0.7	100	87	0.01
702.3	Hor. Plan bracing hip structur	120x120x10 (not coup		2 M20	0.0	4640	4420	0.0	50	43	0.00	0.0	314	0.0	100	87	0.00
703.2	2nd plan bacing	130x130x12#(15,0,33		3 M24	61.7	6040	5728	10.8	50	43	0.25	80.8	452	59.6	100	87	0.69
704	2nd plan bacing	90x90x8		2 M20	2.7	1390	1214	2.2	50	43	0.05	3.9	314	6.3	100	87	0.07
705	2nd plan bacing	90x90x8 (not coupled)		2 M20	0.0	2780	2604	0.0	50	43	0.00	0.0	314	0.0	100	87	0.00
710	Horizontal top of lower ca.	120x120x10		4 M24	12.0	2320	2060	5.8	50	43	0.13	16.6	452	9.2	100	87	0.11
711	Horizontal top of lower ca.	120x120x10		2 M24	1.1	2320	2060	0.5	50	43	0.01	1.5	452	1.7	100	87	0.02
712	Horizontal top of mid ca.	120x120x10		4 M24	12.1	2320	2060	5.9	50	43	0.14	17.0	452	9.4	100	87	0.11
713	Horizontal top of mid ca.	110x110x10		2 M24	1.3	2112	1852	0.7	50	43	0.02	1.6	452	1.8	100	87	0.02
714	Horizontal top of top ca.	120x120x12		4 M24	17.6	2750	2438	7.2	50	43	0.17	26.8	452	14.8	100	87	0.17
715	Horizontal top of top ca.	100x100x10		2 M24	0.8	1920	1660	0.5	50	43	0.01	1.2	452	1.4	100	87	0.02



About DNV

DNV is the independent expert in risk management and assurance, operating in more than 100 countries. Through its broad experience and deep expertise DNV advances safety and sustainable performance, sets industry benchmarks, and inspires and invents solutions.

Whether assessing a new ship design, optimizing the performance of a wind farm, analyzing sensor data from a gas pipeline or certifying a food company's supply chain, DNV enables its customers and their stakeholders to make critical decisions with confidence.

Driven by its purpose, to safeguard life, property, and the environment, DNV helps tackle the challenges and global transformations facing its customers and the world today and is a trusted voice for many of the world's most successful and forward-thinking companies.